

Service Manual LCD TV

CHASSIS : SL-223P

Model : DLP-26C2
DLP-26C3
DLP-32C1
DLP-32C2
DLP-32C3
DLP-37C3
DLP-42C1

Caution

: In this Manual, some parts can be changed for improving. their performance without notice in the parts list. So, if you need the latest parts information, please refer to PPL(Parts Price List)in Service Information Center.

Contents

1. Safety Precautions	3
2. Product Specification	4
2-1. PRODUCT SPECIFICATION	4
2-2. Available Input Signal	6
3. Block Diagram	7
4. Description of Each Block	8
4-1. Block Diagram of Main IC and TP	8
4-2. Overview	9
4-2-1. Composite video, Y/C(S-Video) and SCART(CVBS, RGB) composite video	9
4-2-2. DTV/DVD signal	11
4-2-3. PC(Personal Computer) signal	13
4-2-4. HDMI signal	15
4-2-5. R/G/B PROCESSING(SCART1, TELETEXT R/G/B)	15
4-2-6. Audio signal processing, KEY, and LED	17
4-3. POWER PCB	22
5. SERVICE MODE	25
5-1. Check initial Menu Data	25
5-2. Entering SERVICE MODE	26
6. WHITE BALANCE Adjusting Method	29
7. Main PCBs Trouble Diagnosis	30
7-1. MAIN PCB Trouble Diagnosis	30
7-1-1. Common checking process when “No signal of Noraster”	30
7-1-2. When No Sound	37
7-1-3. When Control Key does not operate	39
7-1-4. When Remote Controller does not operate	40
7-2. POWER PCB	42
8. Trouble Diagnosis	43
8-1. Facts you must know when Diagnosis and Repairing	43
8-2. Typical Symptoms of PCB problem or bad connection	44
9. Structure of LCD Set	45
10. EXPLODED VIEW	47
11. Part List	53
12. Circuit Diagram	67

1. Safety Precautions

- (1) When moving or laying down a LCD Set, please deal with care.
Avoid any impact towards the LCD Set.
- (2) Do not leave the broken LCD Set on for a long time. To prevent any further damages, after check the broken Set's condition, make sure to turn the power(AC) off.
- (3) When opening the BACK COVER, turn off the power(AC) to prevent electric shock.
- (4) When loosening screws, check the connecting position and type of the screw.
Sort out the screws and store them separately.
Because screws holding PCB are working as electric circuit GROUNDING,
make sure to check if any screw is missing when assembling.
- (5) A LCD Set contain different kind of connector cables.
When connecting or disconnecting connector cables, check the direction and position
of the cable beforehand.
- (6) When disconnecting connectors, unplug the connectors slowly with care.
- (7) Connectors are designed so that if the number of pins or the direction does not match,
connectors will not fit.
When having problem in plugging the connectors, make sure to check their kind, position,
and direction.

2. Product Specification

2-1. PRODUCT SPECIFICATION

	Features	DLP-26C2AMSB	DLP-32C2AMSB
LCD Panel	Screen Size	26"	32"
	Aspect Ratio	16 : 9	16 : 9
	Resolution	1366 X 768(WXGA)	1366 X 768(WXGA)
	Pixel Pitch	0.4215mm	0.51075
	Contrast Ratio	1000 : 1	800 : 1
TV System	Receiving System	PAL, SECAM	PAL, SECAM
	Stereo System	2-Carrer/NICAM	2-Carrer/NICAM
	Channel Memory	99ch, Auto Preset	99ch, Auto Preset
Input Connector	RF	75 Ohm Coaxial	75 Ohm Coaxial
	S-Video	1	1
	SCART	2	2
	Component	RCA X 1	RCA X 1
	PC RGB	D-Sub X 1	D-Sub X 1
	PC Audio	3.5mm Mini-Jack	3.5mm Mini-Jack
	HDMI	1	1
Output Connector	SPDIF	Optical-Jack	Optical-Jack
	Headphone	3.5mm Mini-Jack	3.5mm Mini-Jack
	RF-out	1	1
Sound Output		10W	10W
Power Consumption	Max.	120W	160W
	Power Source	110-240V, 50-60Hz	110-240V, 50-60Hz
Dimension(W X H X D)	Set Dimension	812 X 502.7 X 240	944 X 585.5 X 240

Product Specification

	Features	DLP-37C3LMBS	DLP-42C1LMR
LCD Panel	Screen Size	37"	42"
	Aspect Ratio	16 : 9	16 : 9
	Resolution	1366 X 768(WXGA)	1366 X 768(WXGA)
	Pixel Pitch	0.2mm X 0.6mm X RGB	0.227mm X 0.681mm X RGB
	Contrast Ratio	800 : 1	550 : 1
TV System	Receiving System	PAL, SECAM	PAL, SECAM
	Stereo System	2-Carrer/NICAM	2-Carrer/NICAM
	Channel Memory	99ch, Auto Preset	99ch, Auto Preset
Input Connector	RF	75 Ohm Coaxial	75 Ohm Coaxial
	S-Video	1	1
	SCART	2	2
	Component	RCA X 1	RCA X 1
	PC RGB	D-Sub X 1	D-Sub X 1
	PC Audio	3.5mm Mini-Jack	3.5mm Mini-Jack
	HDMI	1	1
Output Connector	SPDIF	Optical-Jack	Optical-Jack
	Headphone	3.5mm Mini-Jack	3.5mm Mini-Jack
	RF-out	1	1
Sound Output		10W	10W
Power Consumption	Max.	200W	220W
	Power Source	110-240V, 50-60Hz	110-240V, 50-60Hz
Dimension(W X H X D)	Set Dimension	940 X 655 X 129	1060 X 758 X 133

Product Specification

2-2. Available Input Signal

2-2-1. HDMI/ PC/COMPONENT

Resolution	V-freq	HDMI	PC(D-Sub)	Component	Standard
640 X 480	60Hz	O	O	X	
	72Hz	O	O	X	
	75Hz	O	O	X	VESA Standard
800 X 600	60Hz	O	O	X	VESA Standard
	72Hz	O	O	X	VESA Standard
	75Hz	O	O	X	
1024 X 768	60Hz	O	O	X	VESA Standard
	70Hz	O	O	X	VESA Standard
	75Hz	O	O	X	VESA Standard
720 X 480P	60Hz	O	X	O	
720 X 576P	50Hz	O	O	O	
1280 X 720P	50Hz	O	X	O	
	60Hz	O	O	O	
1920 X 1080i	50Hz	O	X	O	
	60Hz	O	O	O	
720 X 480i	60Hz	X	X	O	
720 X 576i	50Hz	X	X	O	

2-2-2. VIDEO

- PAL, PAL-M, PAL-N
- NTSC, NTSC4.43
- SECAM

3. Block Diagram

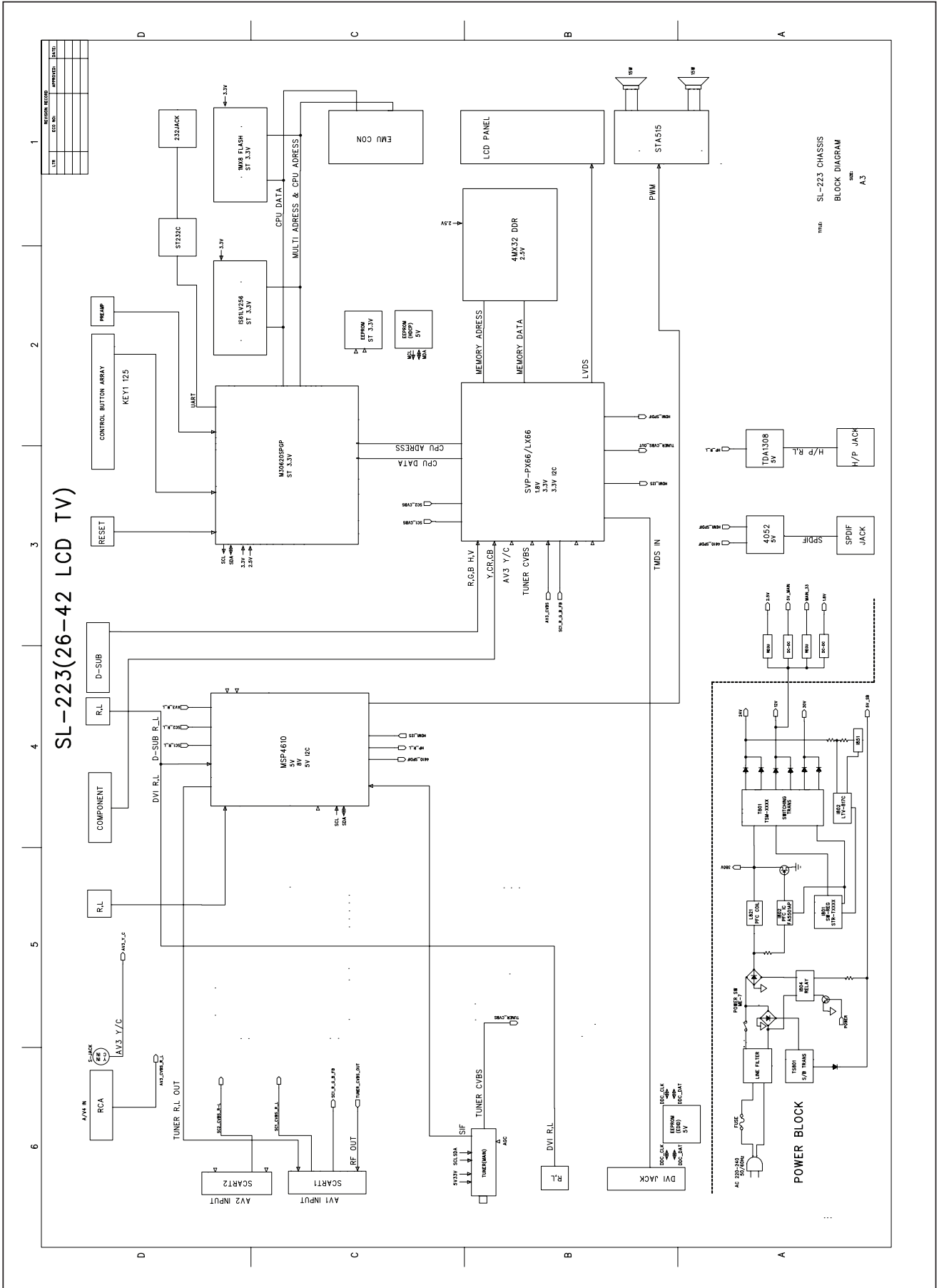

4. Description of Each Block

4-1. Block Diagram of Main IC and TP

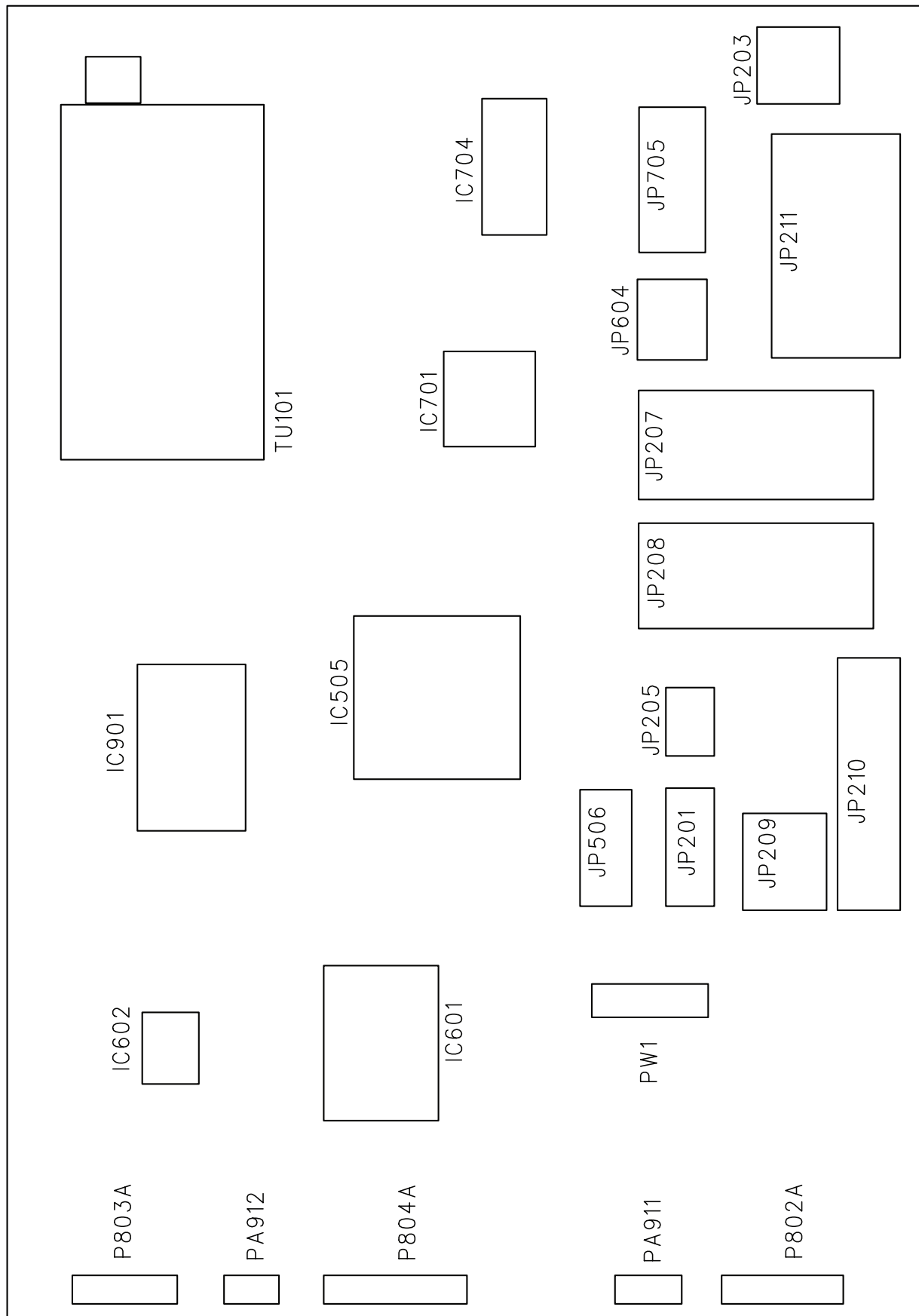

Description of Each Block

4-2. Overview

Digital PCB is Multi Media circuit board that can process various input signals such as video, component, PC, HDMI, and analog TV signal.

4-2-1. Composite video, Y/C(S-Video) and SCART(CVBS, RGB) composite video

- Flow Chart of RF, Video, S-Video Signal

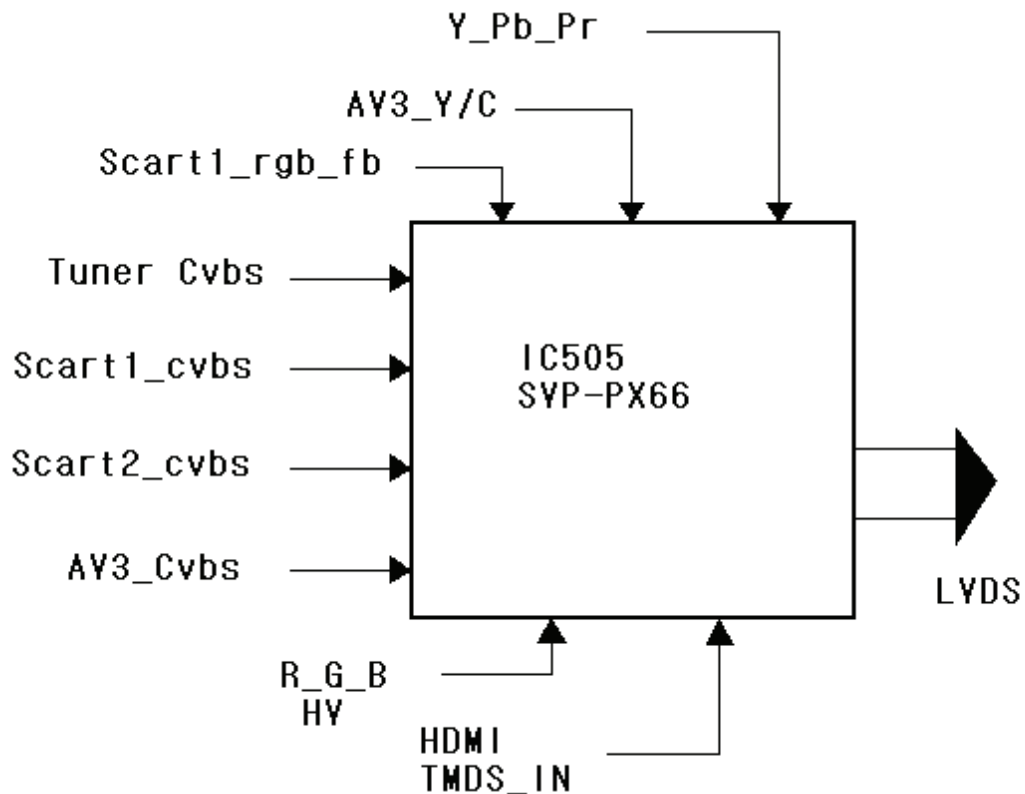

Description of Each Block

Y signal(input to IC505)

Location : CC451

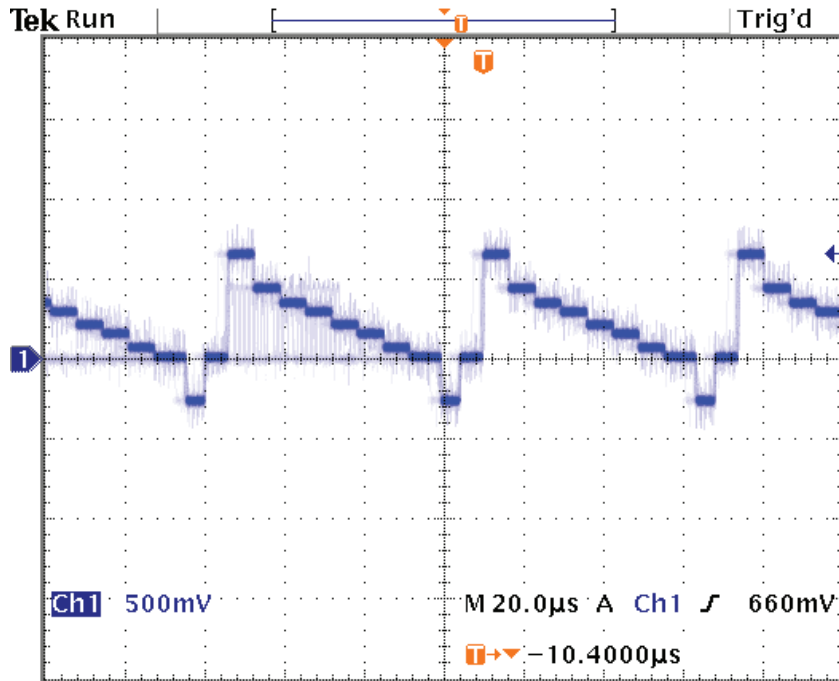

Color signal(input to IC505)

Location : CC456

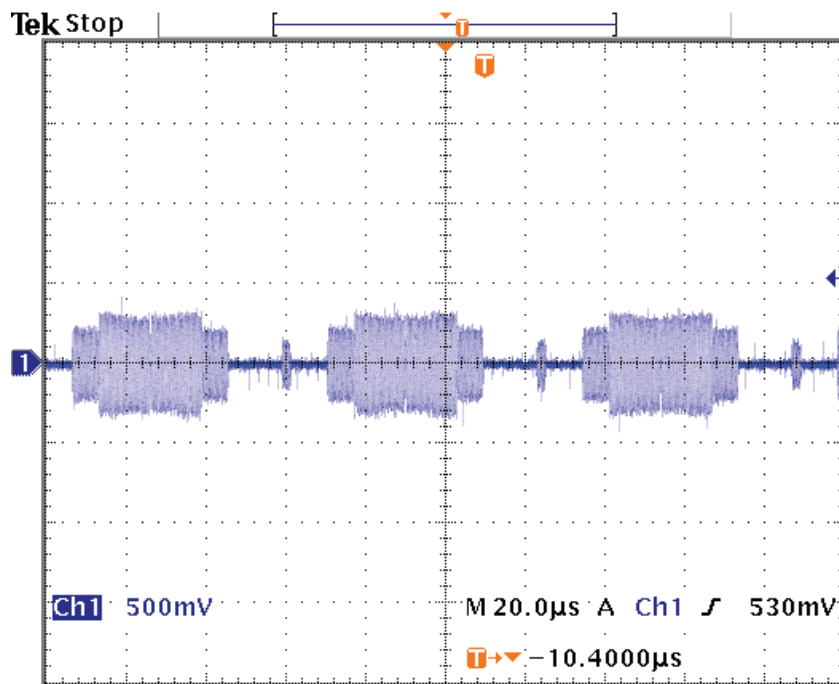

Description of Each Block

CVBS signal(input to IC505)

Location : CC455

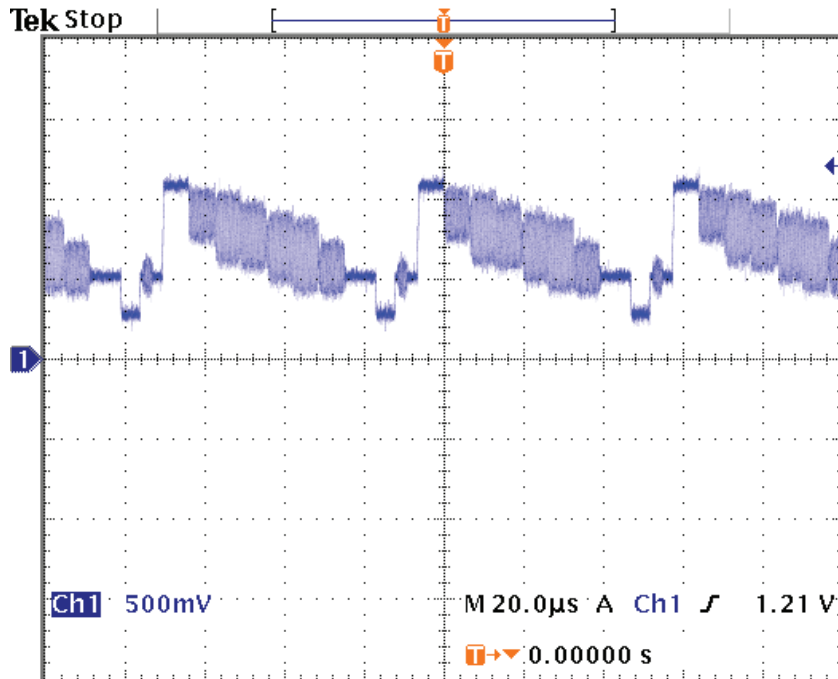

4-2-2. DTV/DVD signal

Y signal(input to IC505)

Location : CC445

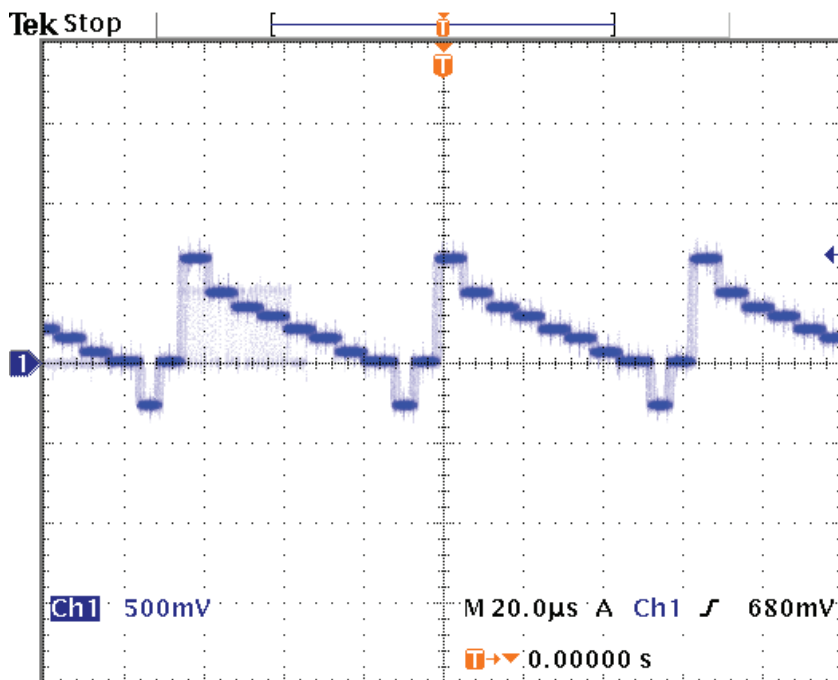

Description of Each Block

Pb signal(input to IC505)

Location : CC446

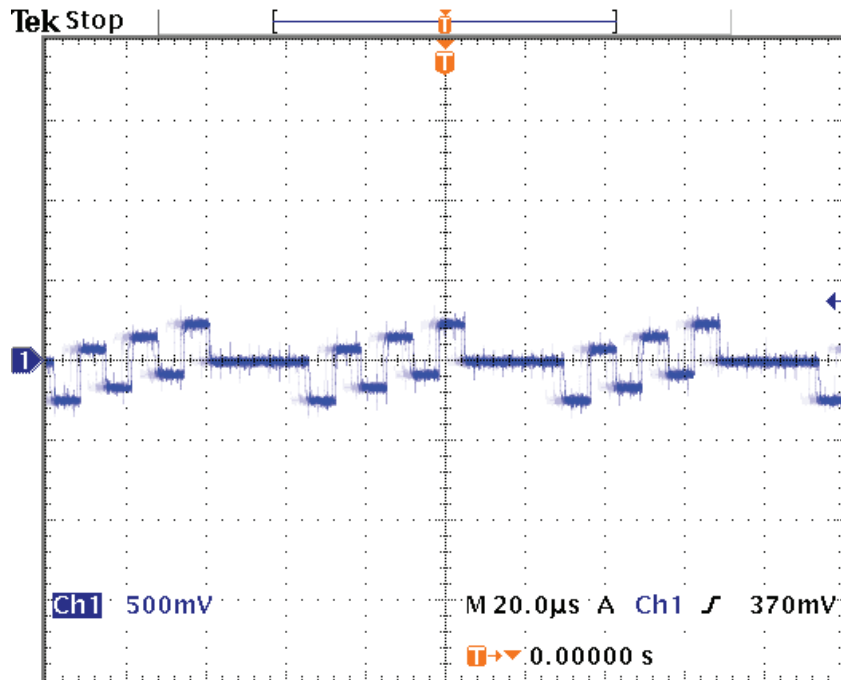

Pr signal(input to IC505)

Location : CC447

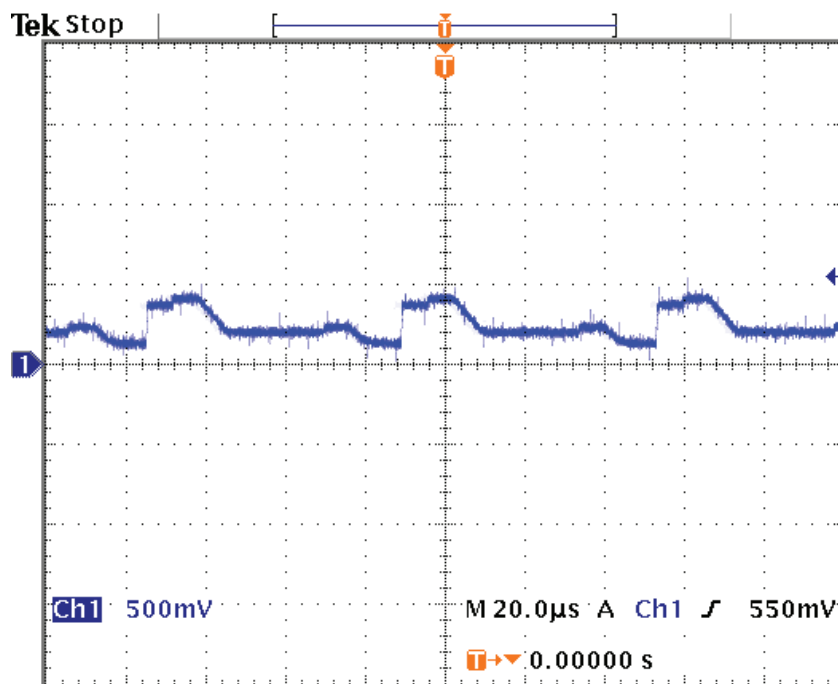

Description of Each Block

4-2-3. PC(Personal Computer) signal
R signal(input to IC505)
Location : CC454

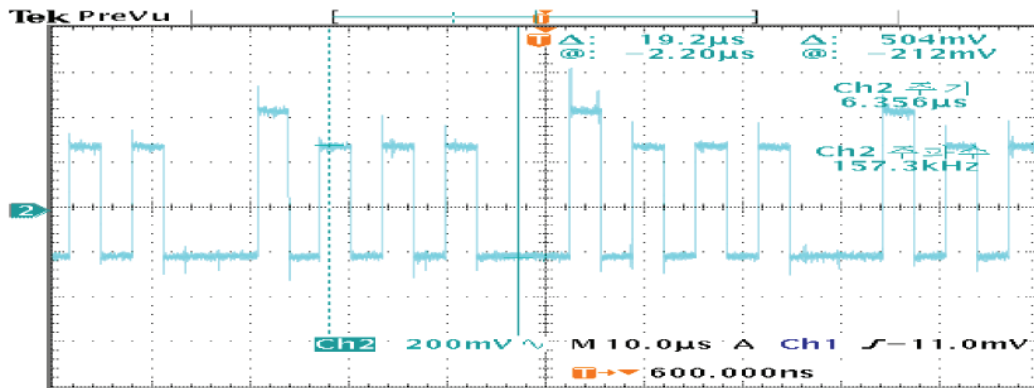

G signal(input to IC505)
Location : CC452

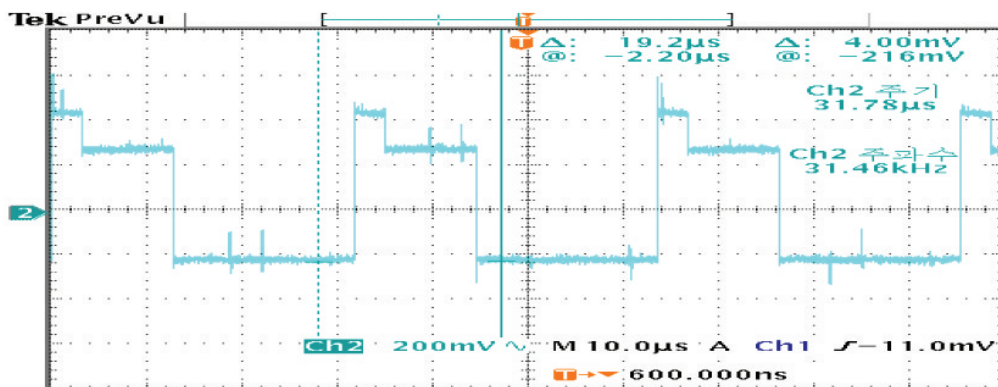

B signal(input to IC505)
Location : CC453

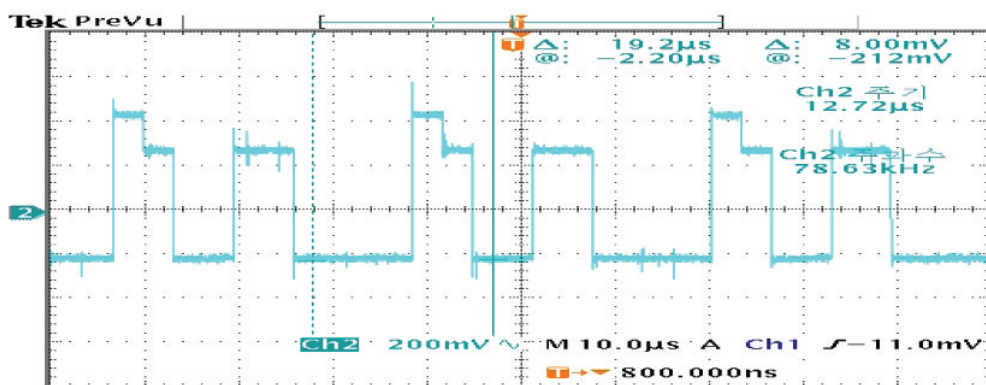

Description of Each Block

Horizontal sync(Output of IC505)

Location : RC458

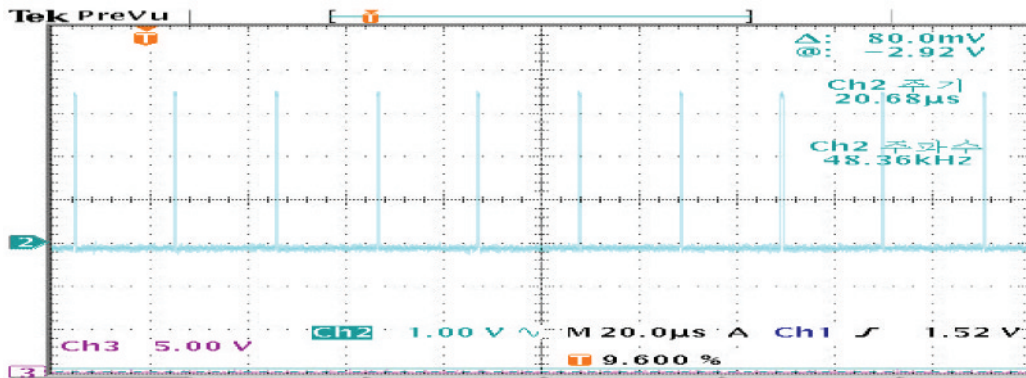

Vertical sync(Output of IC505)

Location : RC459

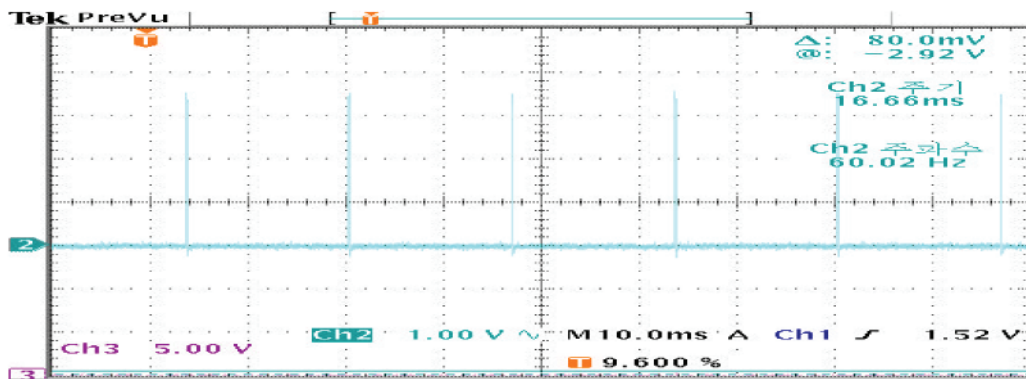

Description of Each Block

4-2-4. HDMI signal

Location : RC465, RC466, RC467, RC468, RC469, RC470, RC471, RC472

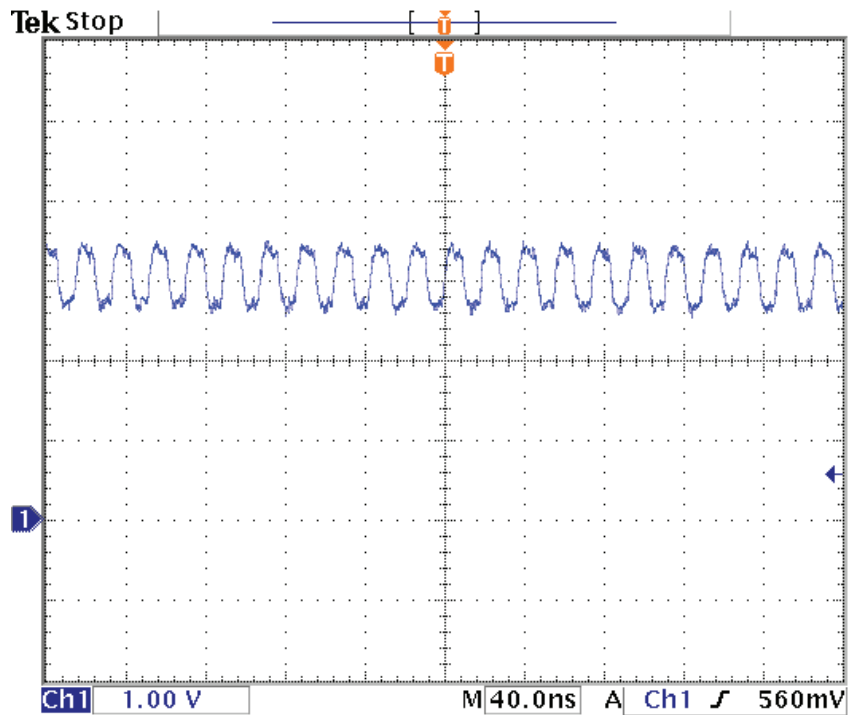

4-2-5. R/G/B PROCESSING(SCART1, TELETEXT R/G/B)

R signal (input to IC505)

Location : RC450

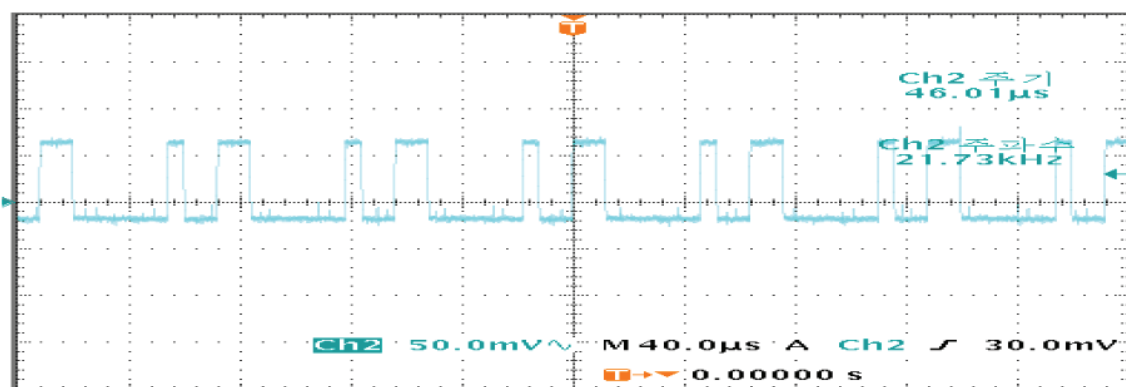

Description of Each Block

G signal(input to IC505)

Location : RC448

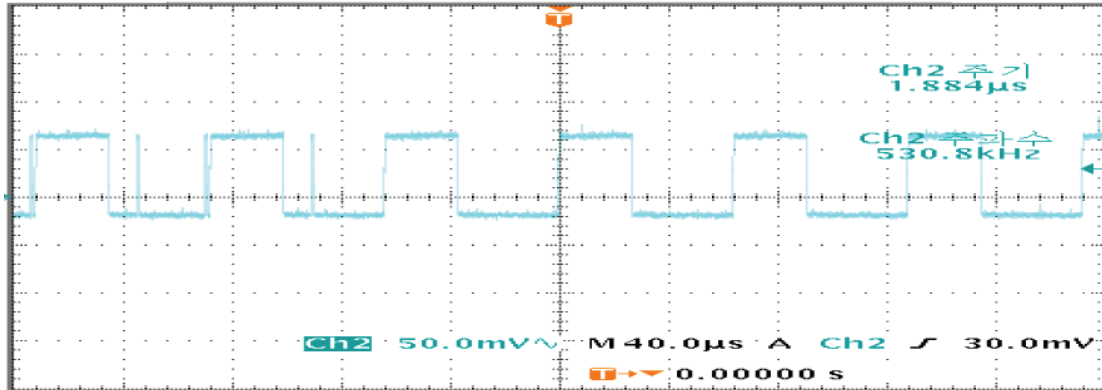

B signal(input to IC505)

Location : RC449

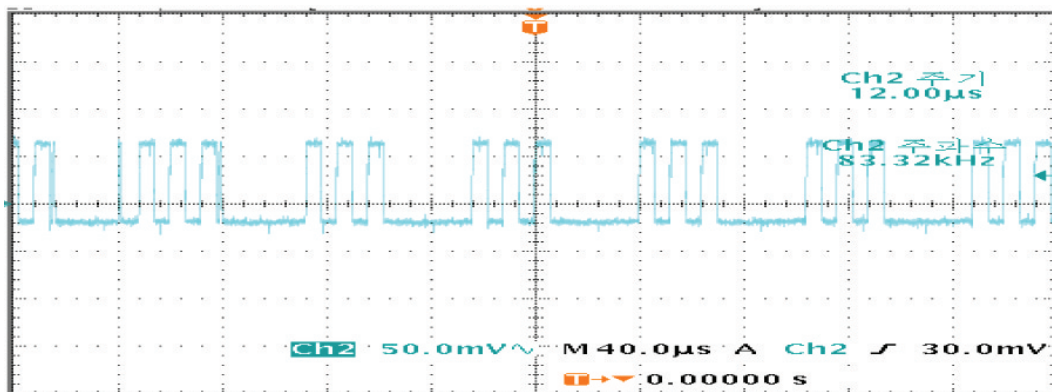

Description of Each Block

4-2-6. Audio signal processing, KEY, and LED

- Flow Chart of Audio signal

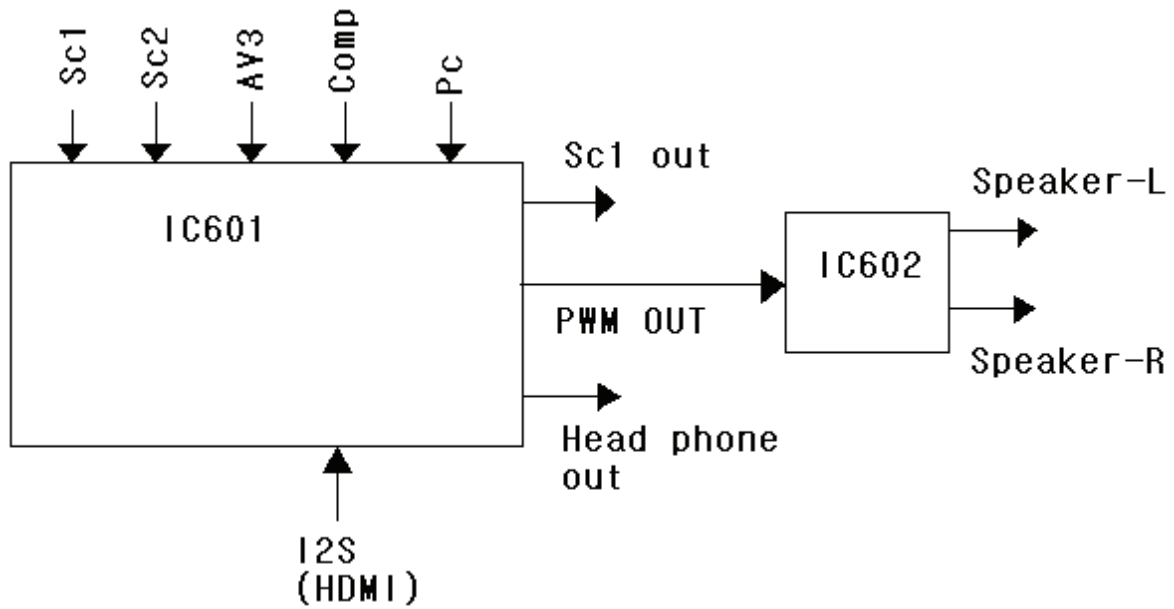

COMP-L sound

Location : ZA225

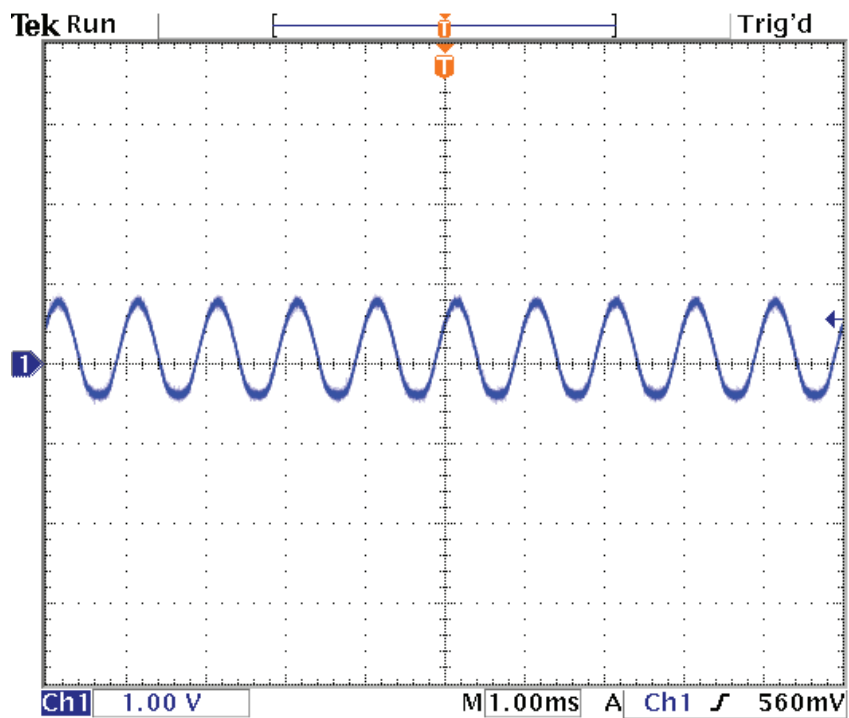

Description of Each Block

IC602 input

Location : RC685, RC687

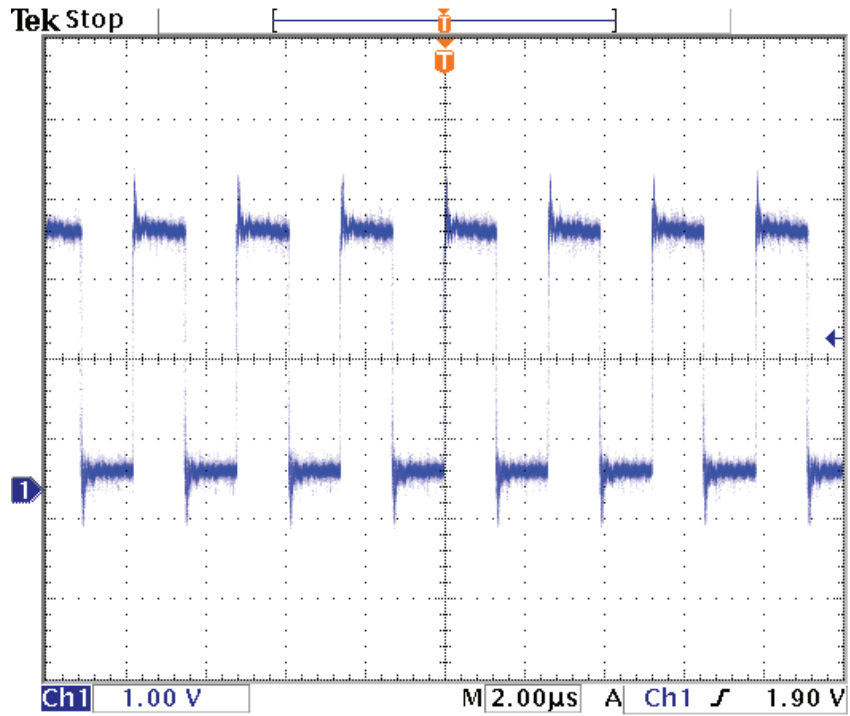

IC602 output

Location : L606, L610

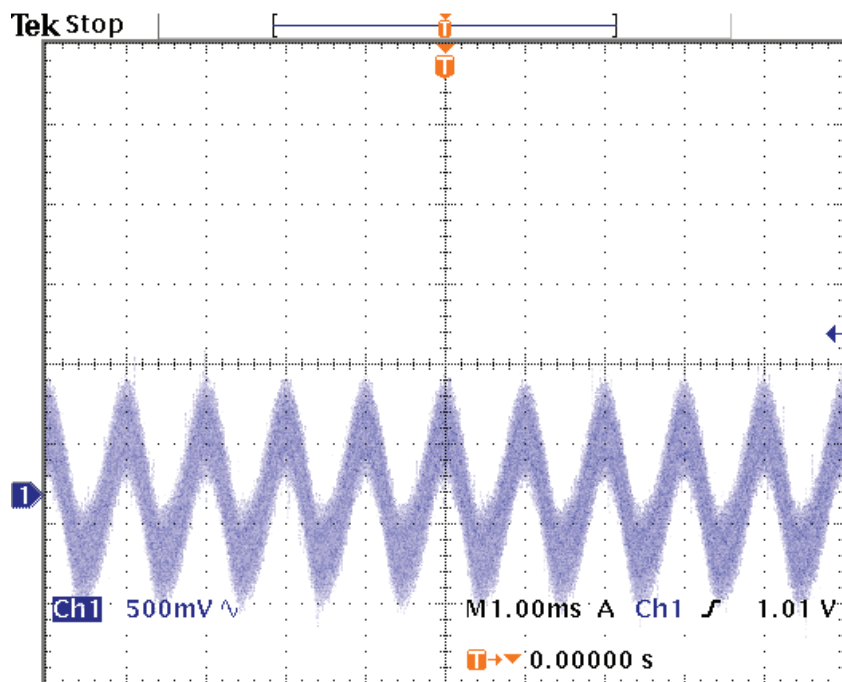

Description of Each Block

SIF input

Location : CC654

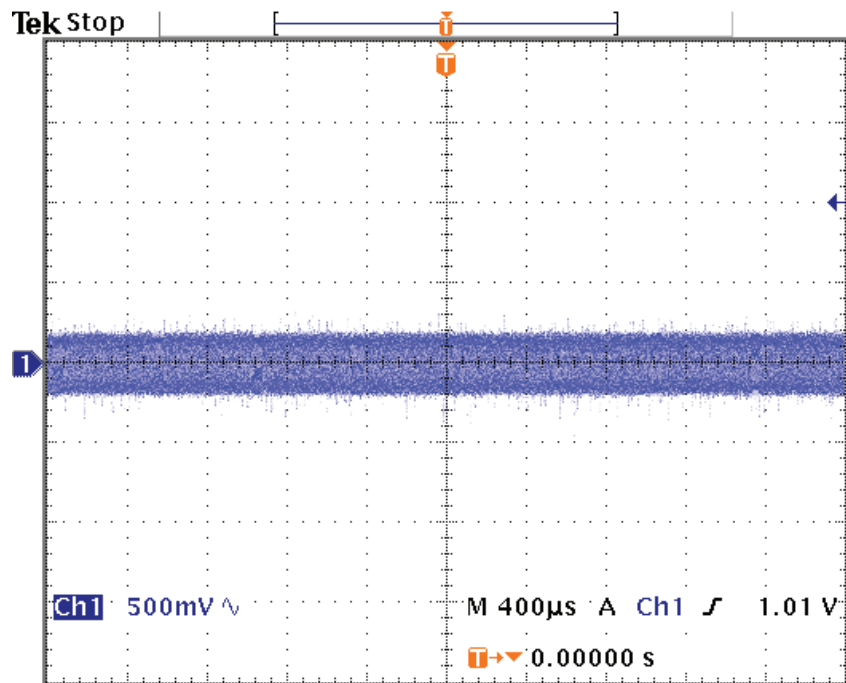

Headphone out

Location : RC611, RC612

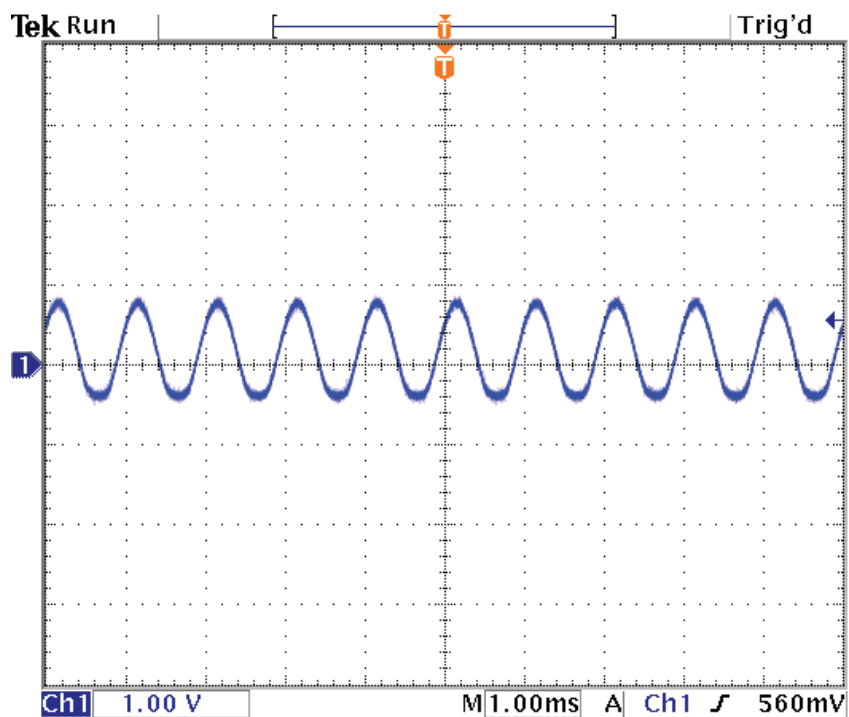

Description of Each Block

SPDIF out

Location : RC655

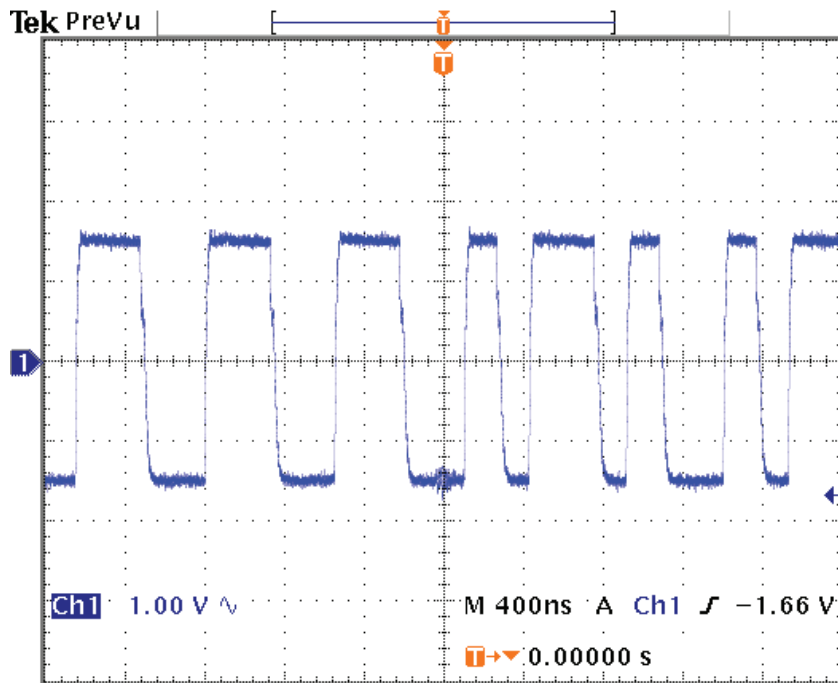

I2S input

Location : RC622(CLK)

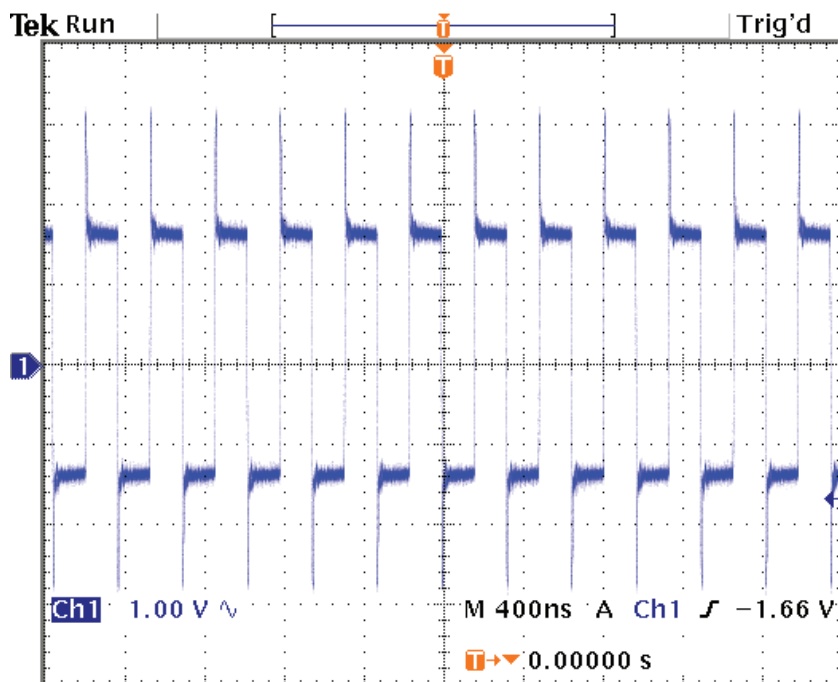

Description of Each Block

Location : RC623(WS)

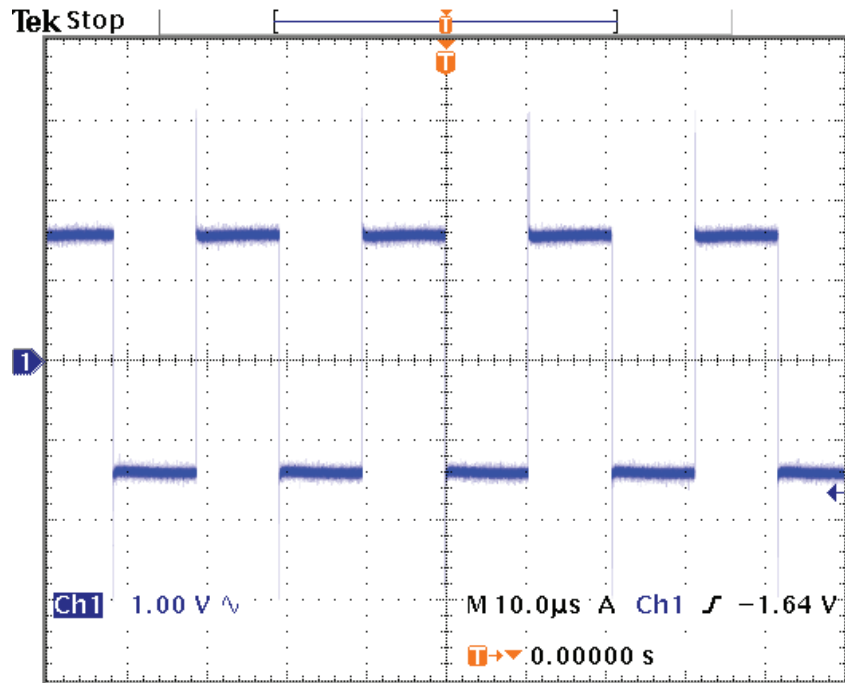

Remote control signal

Location : RC722

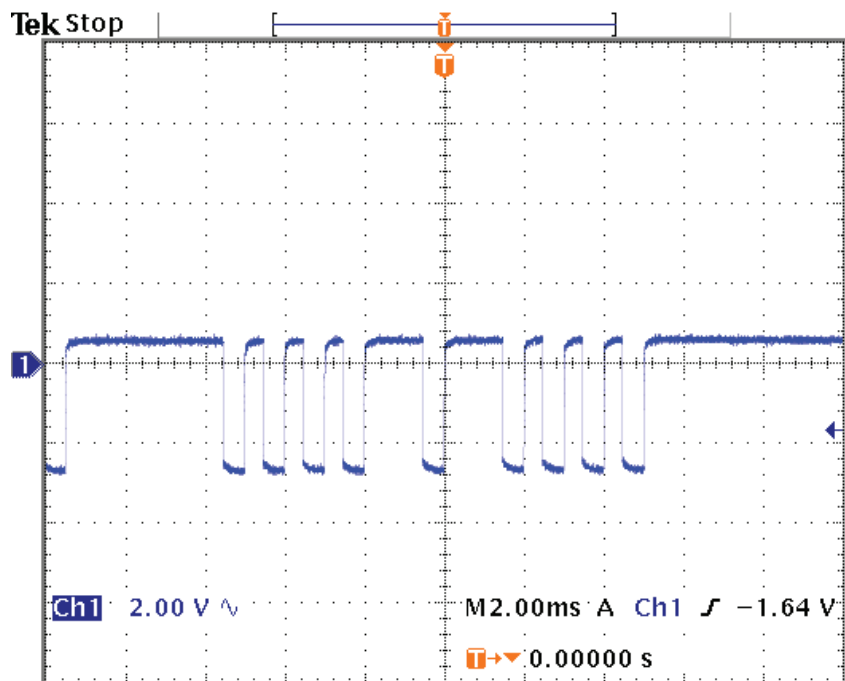

Description of Each Block

4-3. POWER PCB

4-3-1. POWER SPEC

- Rating : 110V~240V
- Regulating Method :
- Input Frequency : 50/60Hz
- Inrush Current : Below 80A at AC230V
- Output Voltage and Current are shown below.

Board	Output Voltage	Minimum output voltage	Maximum output voltage	Output Current			Condition
				MIN	NOR	MAX	
DEP	+29Vdc	+27.0Vdc	+32.0Vdc	0.1A	0.5A	1A	PWR-CTL ON
	+24Vdc	+22.3Vdc	+25.4Vdc	0.1A	6.0A	7.0A	
	+12Vdc	+11.00Vdc	+12.00Vdc	0.1A	1.5A	2.0A	
	+5Vdc	+4.75Vdc	+5.25Vdc	0.1A	1.5A	2.5A	
	ST +5Vdc	+4.75Vdc	+5.25Vdc	0.1A	0.5A	0.6A	PWR-CTL OFF

- Ripple and Noise

Output Name	Output Voltage		AC ripple, switching ripple and noise	Condition
	Minimum output voltage	Maximum output voltage	Continuous	
+29V	+27.0Vdc	+32.0Vdc	500mVp-p	PWR-CTL ON MAX LOAD
+24V	+22.3Vdc	+25.4Vdc		
+12V	+11.00Vdc	+12.00Vdc		
+5V	+4.75Vdc	+5.25Vdc		
ST +5V	+4.75Vdc	+5.25Vdc	500mVp-p	PWR-CTL OFF
	Other Lines		Don't Care	

Description of Each Block

4-3-2. Connectors

A. CN7, CN8 pin Spec(YEN-HO 20010WS-14 14P)

CN7(AUO PANNEL)

PIN NO.	OUTPUT
1	+24V
2	+24V
3	+24V
4	+24V
5	+24V
6	GND
7	GND
8	GND
9	GND
10	GND
11	DIMMING
12	INV ON/OFF
13	N/C
14	GND

CN8(SAMSUNG PANNEL)

PIN NO.	OUTPUT
1	+24V
2	+24V
3	+24V
4	+24V
5	+24V
6	GND
7	GND
8	GND
9	GND
10	GND
11	N/C
12	INV ON/OFF
13	DIMMING
14	N/C

B. CN5, CN6 Pin Spec(YEON-HO 20010WS -12 12P)

CN5, CN6(LG PANNEL)

PIN NO.	OUTPUT
1	+24V
2	+24V
3	+24V
4	+24V
5	+24V
6	GND
7	GND
8	GND
9	GND
10	GND
11	DIMMING
12	INV ON/OFF

Description of Each Block

C. CN2 Pin Spec(YEON-HO YW025-04 4P)

PIN NO.	OUTPUT
1	+29V
2	+29V
3	GND
4	GND

D. CN4 Pin Spec(YEON HO SMW025-09 9P)

PIN NO.	OUTPUT
1	+12V
2	+12V
3	GND
4	GND
5	+5VS
6	PWR ON/OFF
7	GND
8	GND
9	+5VS

E. CN3 Pin Spec(CA3237W-300-08P)

PIN NO.	OUTPUT
1	DIMMING
2	INV ON/OFF
3	N/C
4	GND
5	GND
6	+5VS
7	+5VS
8	+12V

5. SERVICE MODE

5-1. Checking initial Menu Data

5-1-1. Check initial data of User Menu

A. Picture

- Mode : Standard
- Brightness : 32
- Contrast : 58
- Color : 32
- Sharpness : 32
- Tint : 0
- ColourTemp : Normal

B. Screen

- Aspect : 16:9

C. Sound

- Mode : News
- 100Hz : 0
- 300Hz : 0
- 1KHz : 0
- 3KHz : 0
- 10KHz : 0
- 3D-Panorama : Off
- Dynamic Bass : Off
- Balance : 0

D. Function

- Language
- Timer
 - Clock : --:--
 - Auto Clock : No
 - Auto Clock Pr : ___
 - Wake up : No
 - Wake up Time : --:--
 - Wake up Pr : ___
 - Off Timer : No
 - Off Time : --:--
- Child Lock : Off
- MGD I DEMO

E. Install

- Auto Tuning
 - Country Set : Austria
- Manual Tuning
- Setup
 - Program : 00
 - Channel : _ _

SERVICE MODE

- Name : _____
- System : PAL
- Sound : BG
- Fine Tuning : 0
- Edit

5-2. Entering SERVICE MODE

Using the Service Remote controller, you can enter service mode directly.

5-2-1. Adjustment REMOCON and EEPROM initial DATA

A. The adjustment Specification use the SERVICE REMOCON R-34SVC
(S/N: 48B3034SVC)

B. Adjustment DATA

Key	Name	Details	Function		Remark
			Default	Adjustment	
S1	Heat-Run				
S2	-		Gumi Channel Map Write		
S3	Volume Test		Volume : 0 -> 32 -> 63 -> L -> R		
S4	EDID write	Operating Method	1. Connect P701(Jumper) of Main PCB. 2. Press the "S4" key of service remocon. And then, TV set display "EDID WRITE OK" upper left of screen. 3. After EDID WRITE, remove P701(Jumper)		
S5	PANEL TEST		PATTEN : BLACK -> WHITE -> RED -> GREEN -> BLUE		
S6	PICTURE TEST		PATTEN : BRIGHT MIN -> CEN -> MAX -> CONTRAST MIN -> CEN -> MAX -> COLOR MIN -> CEN -> MAX		
S7	-		DEMPOL Channel Map Write		
S8	White balance /EEPROM Erase	EEPROM Erase operating method	1. Press the "S8"key of service remocon. 2. Press the "OK"key of user remocon. And then, TV set display "EEPROM CLEARED" upper left of screen. 3. When you turn off/on AC, EEPROM data will be cleared.		
			Default	Adjustment	
			26"(32")	-	FIX
		CUT OFF R	379(400)	-	FIX
		CUT OFF G	447(448)	-	FIX
		CUT OFF B	431(403)	-	FIX
		DRIVE R	373(340)	-	FIX
		DRIVE G	328(310)	-	FIX
		DRIVE B	322(330)	-	FIX
	AUTO Y CLAMP			DO NOT USE	
	AUTO Y GAIN			DO NOT USE	

SERVICE MODE

Key	Name	Details	Function		Remark
			Default	Adjustment	
S9	Device Control		Default	Adjustment	
		Video sub bri	35	FIX	Do Not Use
		Video sub cont	118	FIX	Do Not Use
		Video sub Cb	112	FIX	Do Not Use
		Video sub Cr	112	FIX	Do Not Use
		Video sub hue	0	FIX	Do Not Use
		Video YC delay	0	FIX	Do Not Use
		Pedestal level	On	FIX	Do Not Use
		Anti alias	On	FIX	Do Not Use
		PIP Brightness	9	FIX	Do Not Use
		PIP Contrast	109	FIX	Do Not Use
		Y/G clamp	0	FIX	Do Not Use
		Pb clamp	0	FIX	Do Not Use
		Pr clamp	0	FIX	Do Not Use
		Y/G gain	0	FIX	Do Not Use
		Peaking Threshold	23	FIX	Do Not Use
		Peaking Pos_Gain	163	FIX	Do Not Use
		Peaking Neg_Gain	163	FIX	Do Not Use
		AOL	112	FIX	Do Not Use
		Threshold	0	FIX	Do Not Use
		Tuner AGC	+2	FIX	Do Not Use
		Cb Offset	1	FIX	Do Not Use
		Cr Offset	1	FIX	Do Not Use
ADC1 AGC	120	FIX	Do Not Use		
S10	-	SSC Enable	SSC ON/OFF.		
		SSC Data	SSC Enable On Value : 0 -> 1 -> ... -> 7		
		Dimming Control	Default	Adjustment	
			26" : 255(MAX)	0 - 255	FIX
			32" : 0(MAX)	0 - 255	FIX
		Panel Type	26 -> 32 -> 37 -> 42		
		Key Type	C1/C3 -> C2		
			Default	Adjustment	
		Normal Brightness	76	-	
		Normal Contrast	95	-	
A/V Audio Delay	0	-	Fix		
Comp Audio Delay	0	-	Fix		
S11	I2C Stop		For debugging mode.		
S12	Shipping	-			

SERVICE MODE

5-2-2. Description of SERVICE MODE ITEM

A. S1(1) : Heat-Run Key

B. S2(2) : Gumi Channel Map Write

C. S3(3) : Volume Test

=> This key can check sound

D. S4(4) : EDIE WRITE

=> Using this key, you can update EDID data.

E. S5(5) : PANEL TEST

=> Using this key, you can test problem of PANEL, as confirm white pattern, red pattern, blue pattern, green pattern.

F. S6(6) : PICTURE TEST

=> Using this key, you can test brightness, contrast and color.

G. S7(7) : DEMPOL CHANNEL MAP WRITE

H. S8(8) : EEPROM Erase and White Balance adjustment

=> Using this key, you can erase EEPROM data and adjust White balance.

I. S9(9) : Device control

=> This key only use for R&D.

J. S10(10) : Option key

=> Using this key, you can adjust SSC, Dimming, Panel Type, Control key and etc.

K. S11(11) : I2C STOP key

=> This key only use for R&D.

L. S12(SLEEP) : Shipping key

=> Using this key, you can set up at shipping mode.

6. WHITE BALANCE Adjusting Method

To adjust WHITE BALANCE, refer to below process.

6-1. Insert white pattern to component input

Signal Generator : 802BT (By Quantum Data)

Resolution : 1280x720p @60Hz,

Pattern : Grey Scale (11 step)

6-2. Confirm 'dimming' in service mode (=s10)

32C3 = 0, 26C3 = 255

6-3. Attach white balance meter(CA-210) on center of Panel

6-4. Press the service key s8

6-5. Adjust white balance with variable R.G.B cutoff / drive.

Color coordinates

X = 0.280 0.01, Y = 0.285 0.01, cd/m² = 50cd/m²

X = 0.280 0.01, Y = 0.290 0.01, cd/m² = 300cd/m²

6-6. Press s8 button to escape SERVICE MODE

The difference of LCD Panel is not so much, therefore we don't adjust white balance.

7. Main PCBs Trouble Diagnosis

7-1. MAIN PCB Trouble Diagnosis

7-1-1. Common checking process when “No signal of Noraster”

No signal : OSD is working but no images are displaying

No raster : OSD as well as images in not working

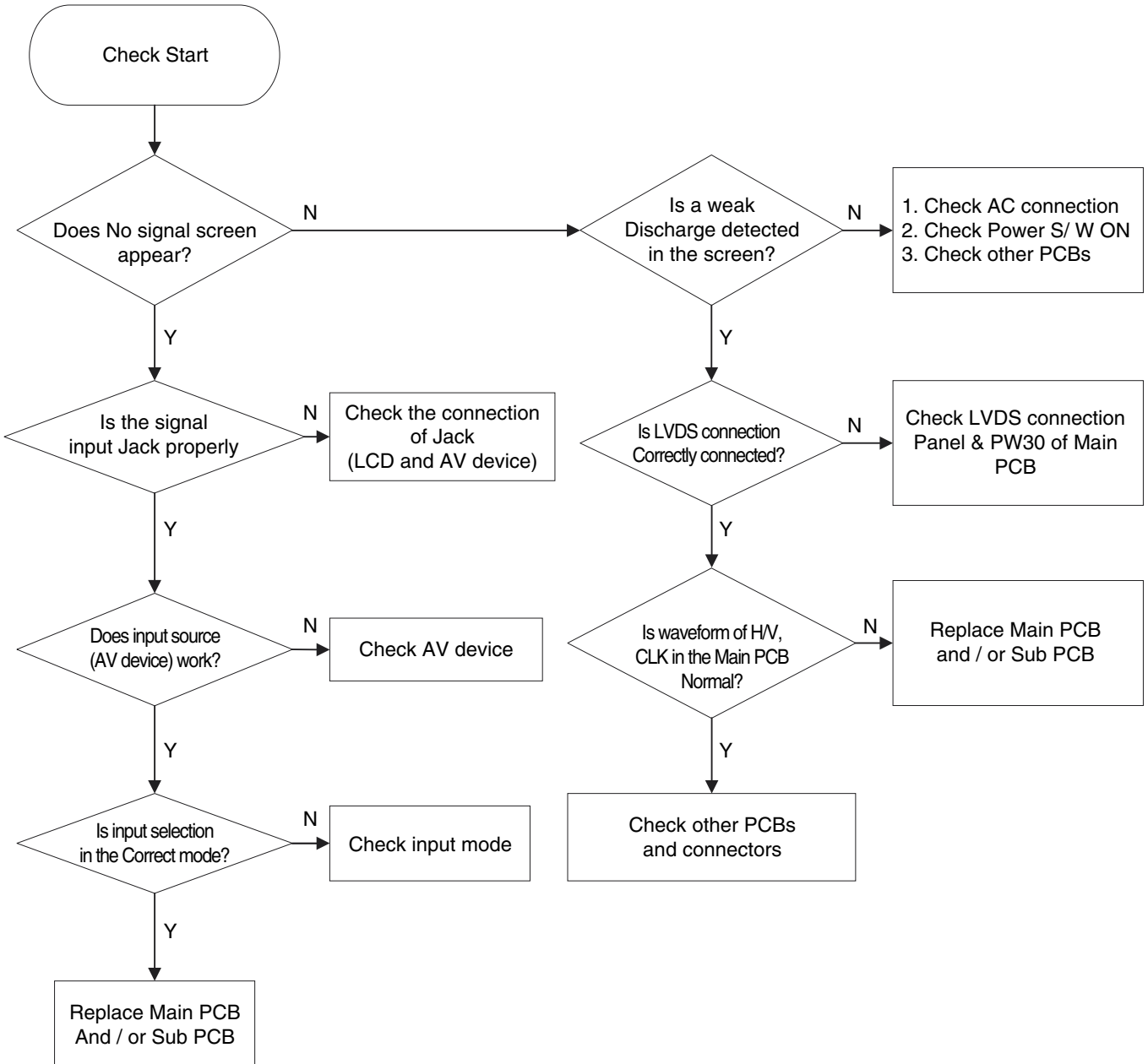

Main PCBs Trouble Diagnosis

A. When "No signal" in CVBS(RF, AV)

1) First check if other inputs are working

-> if other inputs are not working, replace MAIN PCB

2) Checking waveforms with Color Bar Pattern(Using the oscilloscope)

- Main TP(RF) : CC455, C102

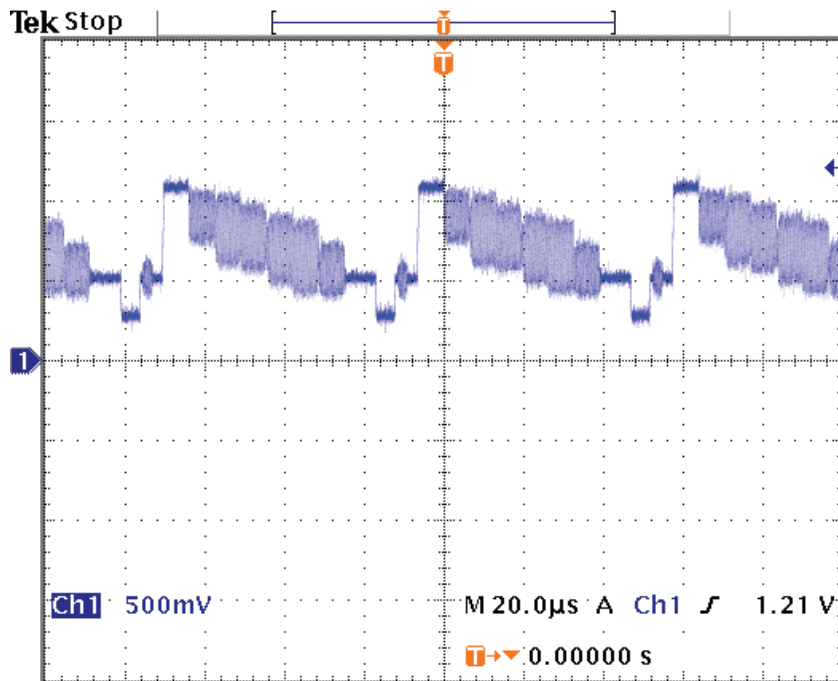

- Main TP(AV) : LC205, CC444

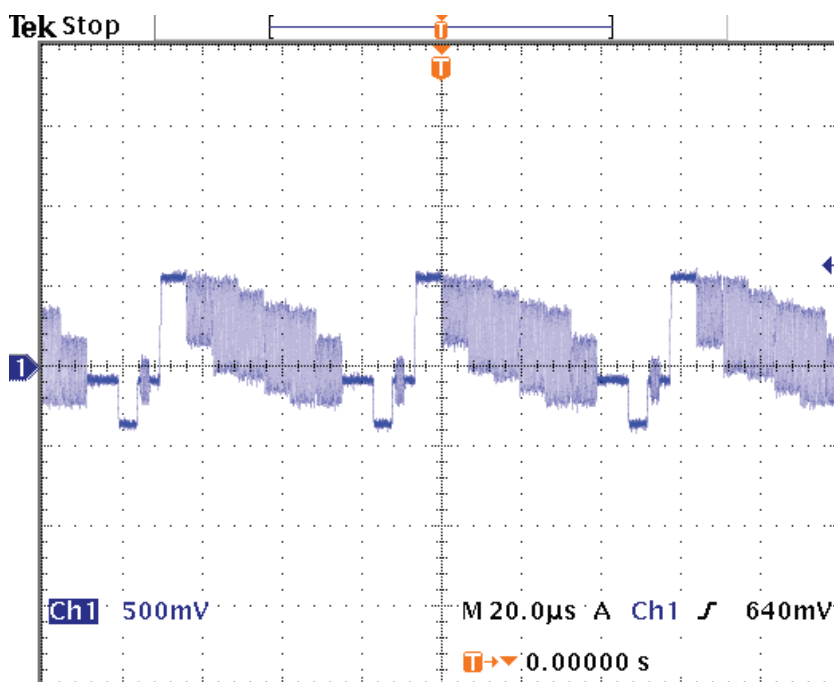

Main PCBs Trouble Diagnosis

B. When “No signal” in Y/C signal(S-Video)

- 1) First check if other inputs are working
 - > if other inputs are not working, replace MAIN PCB
- 2) Checking waveforms with Color Bar Pattern(Using the oscilloscope)
 - Main TP(Y signal) : CC451

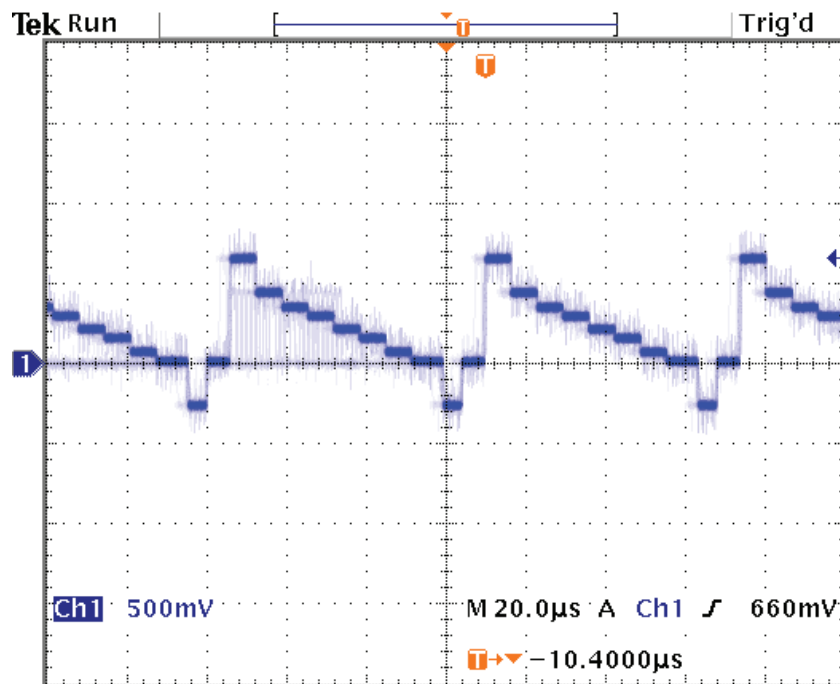

- Main TP(C signal) : LC202, CC456

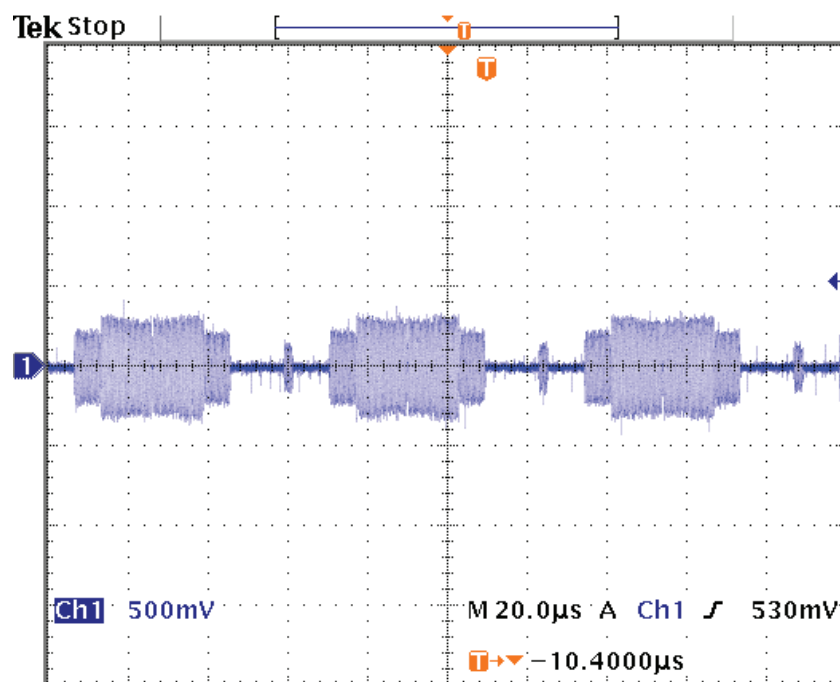

Main PCBs Trouble Diagnosis

C. When “No signal” in Y/Pb/Pr signal(Component)

1) First check if other inputs are working

-> if other inputs are not working, replace MAIN PCB

2) Checking waveforms with Color Bar Pattern(Using the oscilloscope)

- Main TP(COMP1_Y) : CC445, LC224, LC221

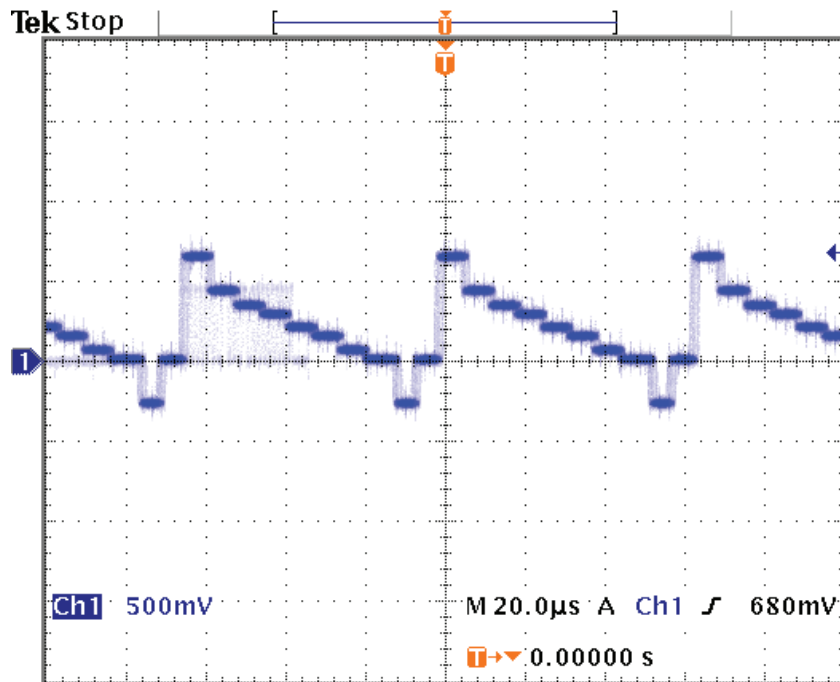

- Main TP(COMP1_Pb) : CC446, LC222, LC225

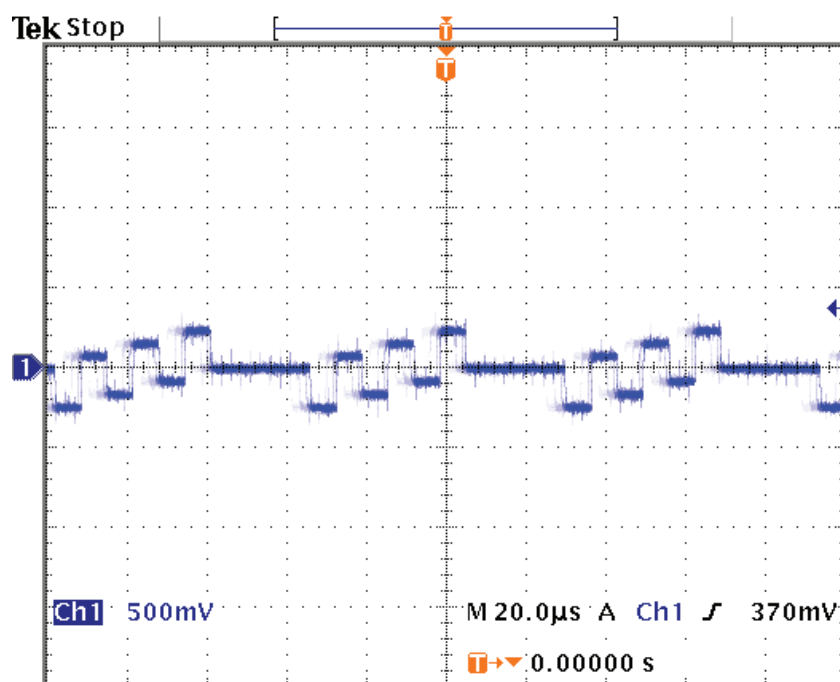

Main PCBs Trouble Diagnosis

- Main TP(COMP1_Pr) : CC447, LC226, LC223

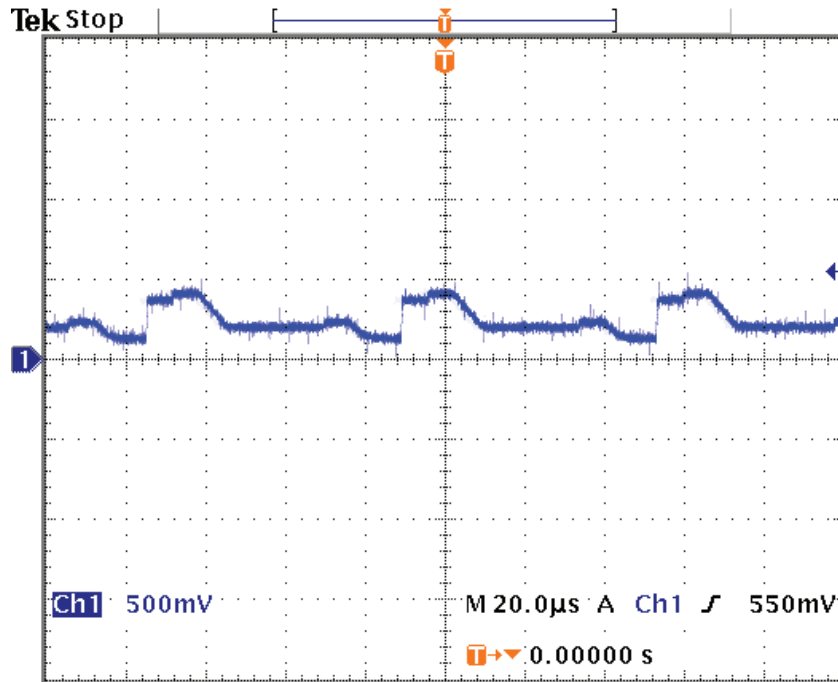

D. When “No signal” in PC

- 1) First check if other inputs are working
 - > if other inputs are not working, replace MAIN PCB
- 2) Checking waveforms with Color Bar Pattern(Using the oscilloscope)
 - Main TP(R signal) : LC217, CC454

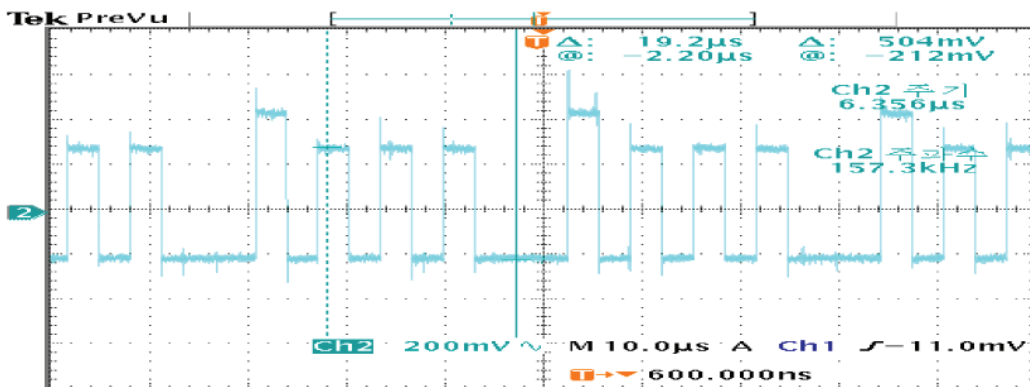

Main PCBs Trouble Diagnosis

- Main TP(G signal) : CC452, LC218

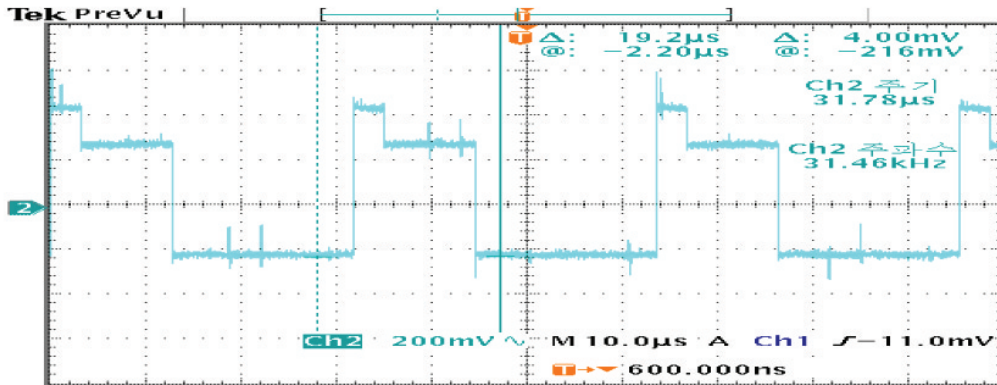

- Main TP(B signal) : LC219, CC453

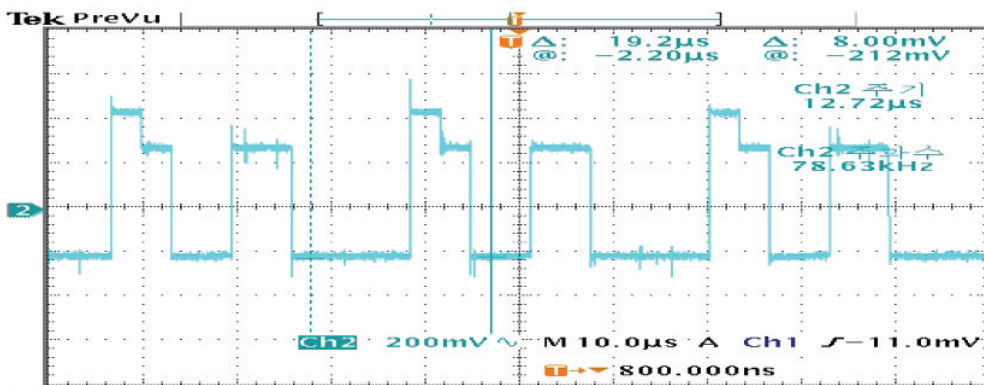

- Main TP(H-sync) : RC458

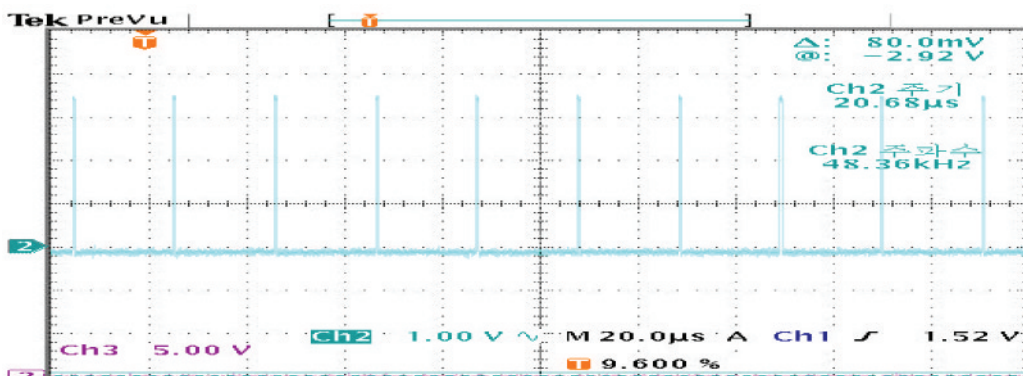

Main PCBs Trouble Diagnosis

- Main TP(V-sync) : RC459

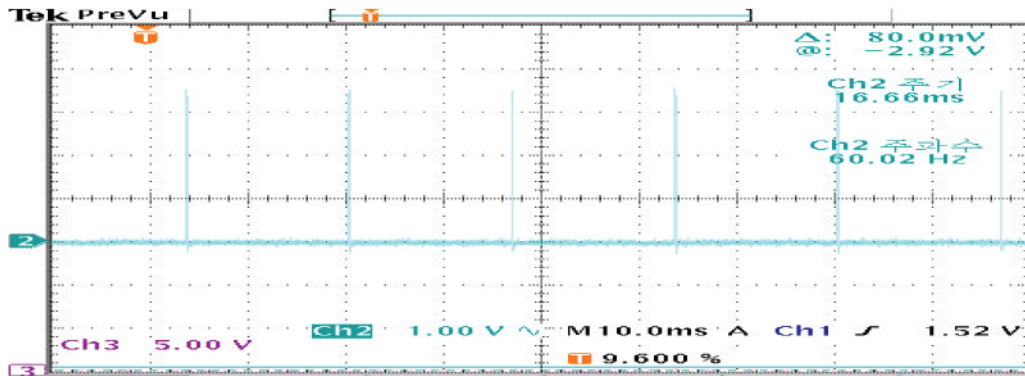

E. When “No signal” in HDMI

1) First check if other inputs are working

-> if other inputs are not working, replace MAIN PCB

2) Checking waveforms with Color Bar Pattern(Using the oscilloscope)

- Main TP : RC465, RC466, RC467, RC468, RC469, RC470, RC471, RC472

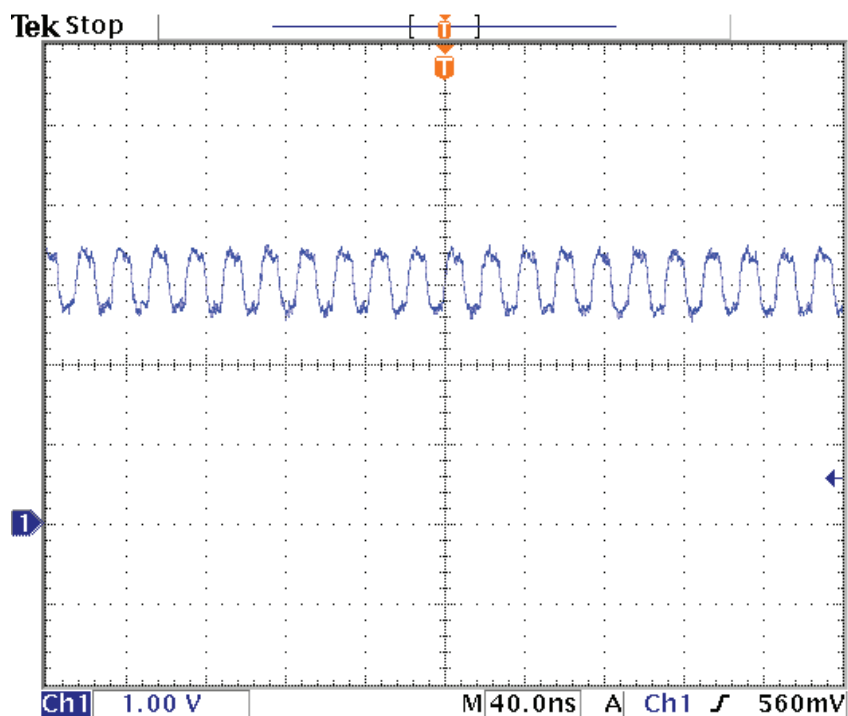

Main PCBs Trouble Diagnosis

7-1-2. When No Sound

A. Overview

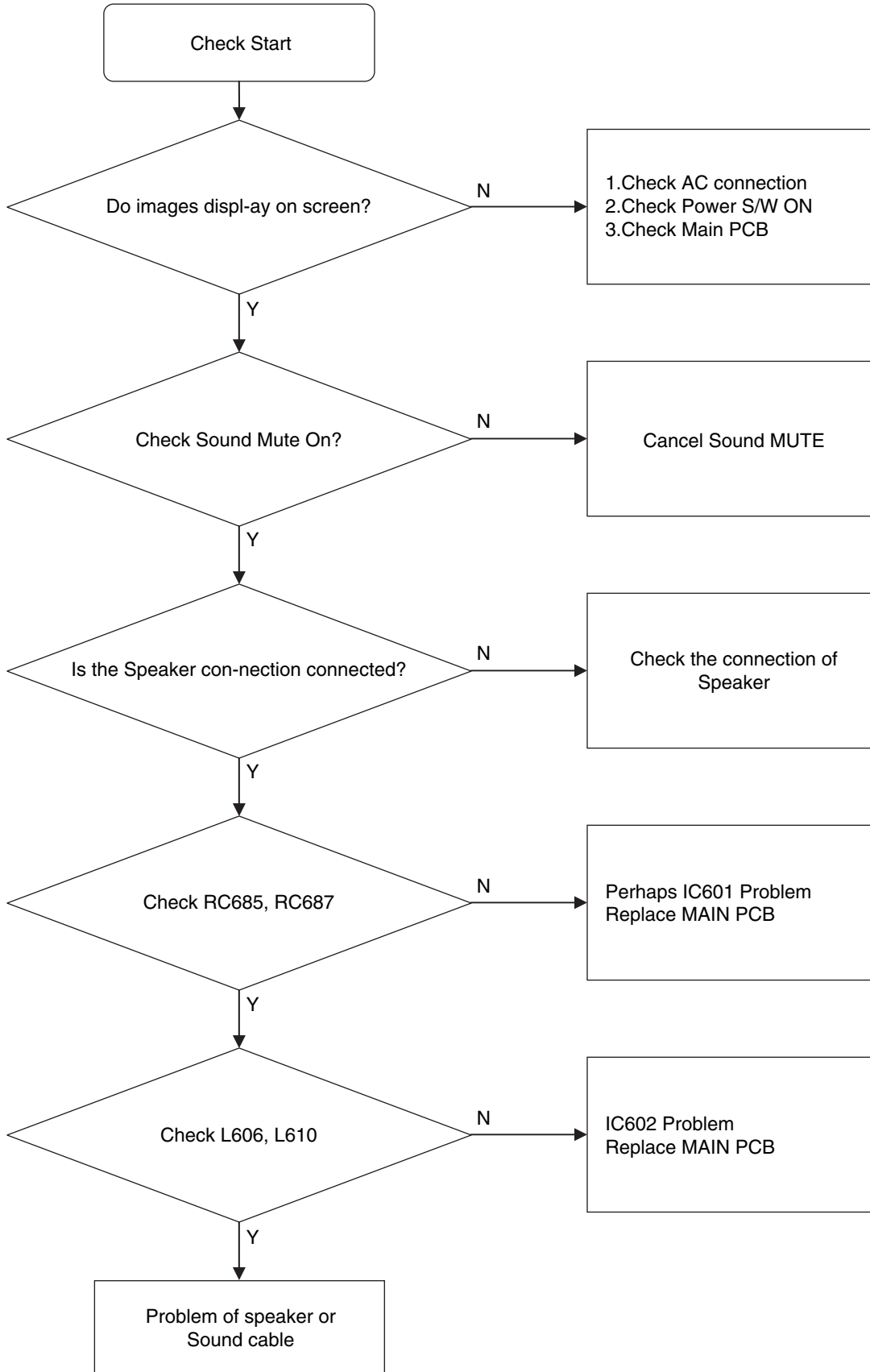

Main PCBs Trouble Diagnosis

- 1) First check if images are displaying
-> If images are not displaying, replace MAIN PCB
- 2) Checking waveforms with 1KHz Sound pattern

B. Main TP

- Input to IC601 : CC614, CC615(Scart 1) , CC612, CC613(Scart2), CC611, CC610(AV), CC650, CC651(COMP), CC625 ,CC626(PC L/R)

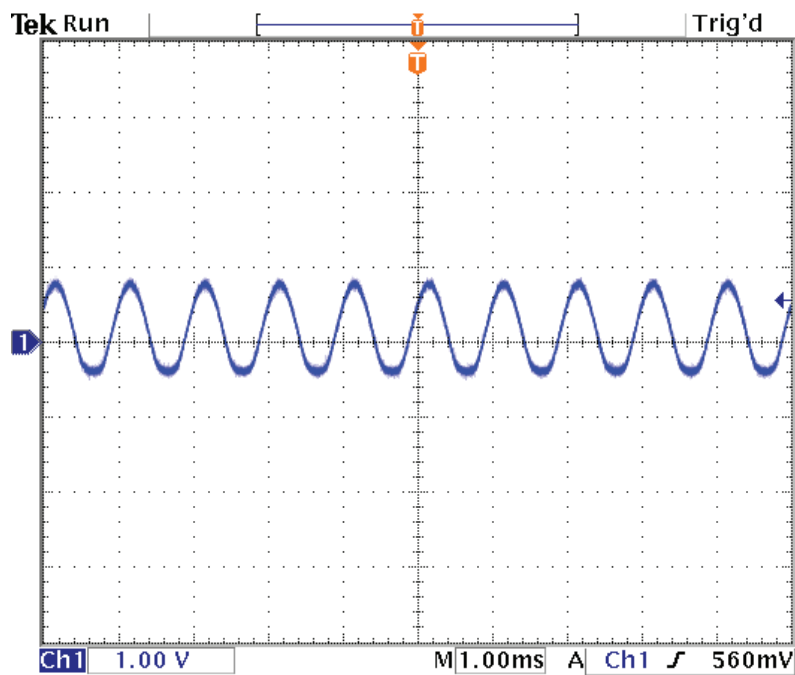

- Output of IC602 : L606, L610

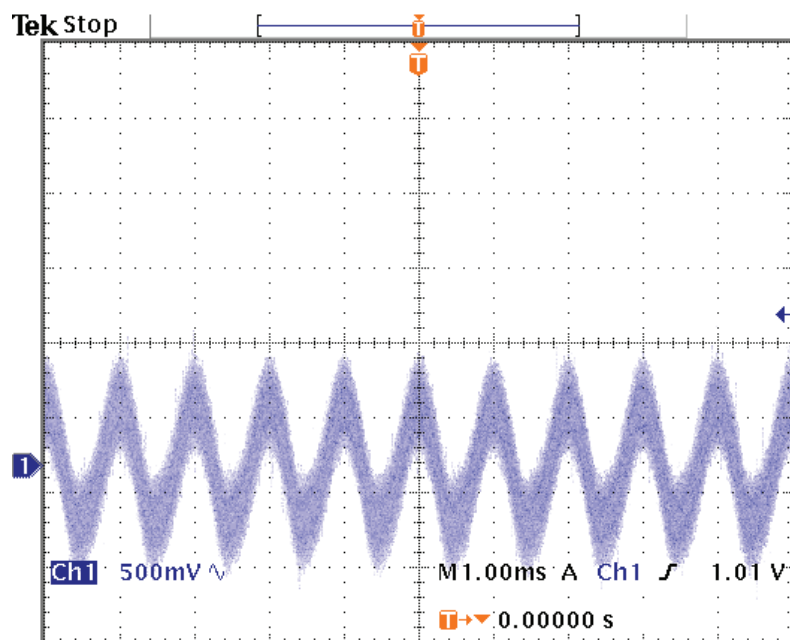

Main PCBs Trouble Diagnosis

7-1-3. When Control Key does not operate

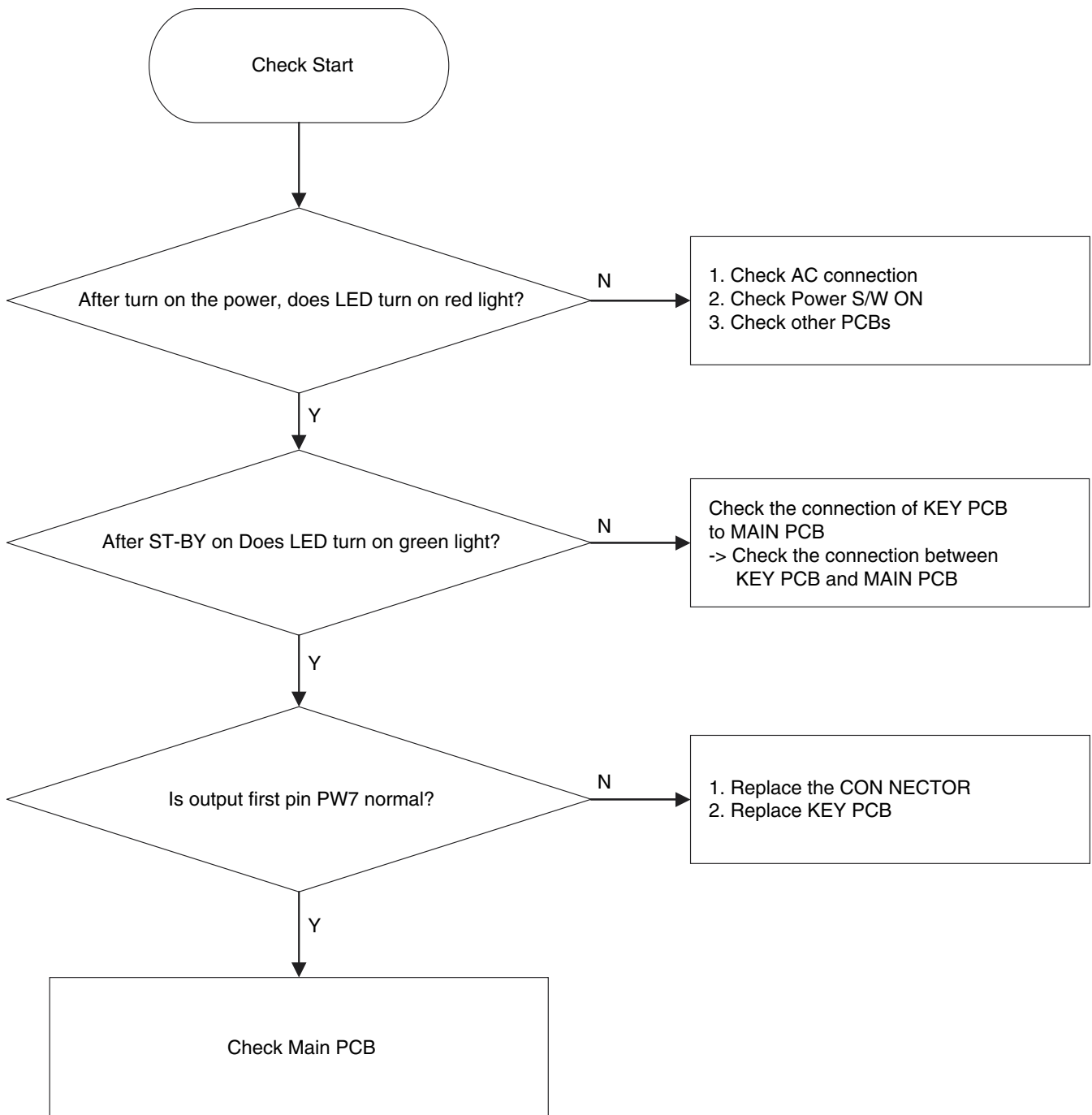

- A. First check connection, and then check the output of first pin of PA912(ST-BY 3.3V)
- B. Check waveform first pin and third pin of PA911.
If waveform does not appear, replace connector or KEY PCB.
-main TP : RC398, RC399

Main PCBs Trouble Diagnosis

7-1-4. When Remote Controller does not operate.

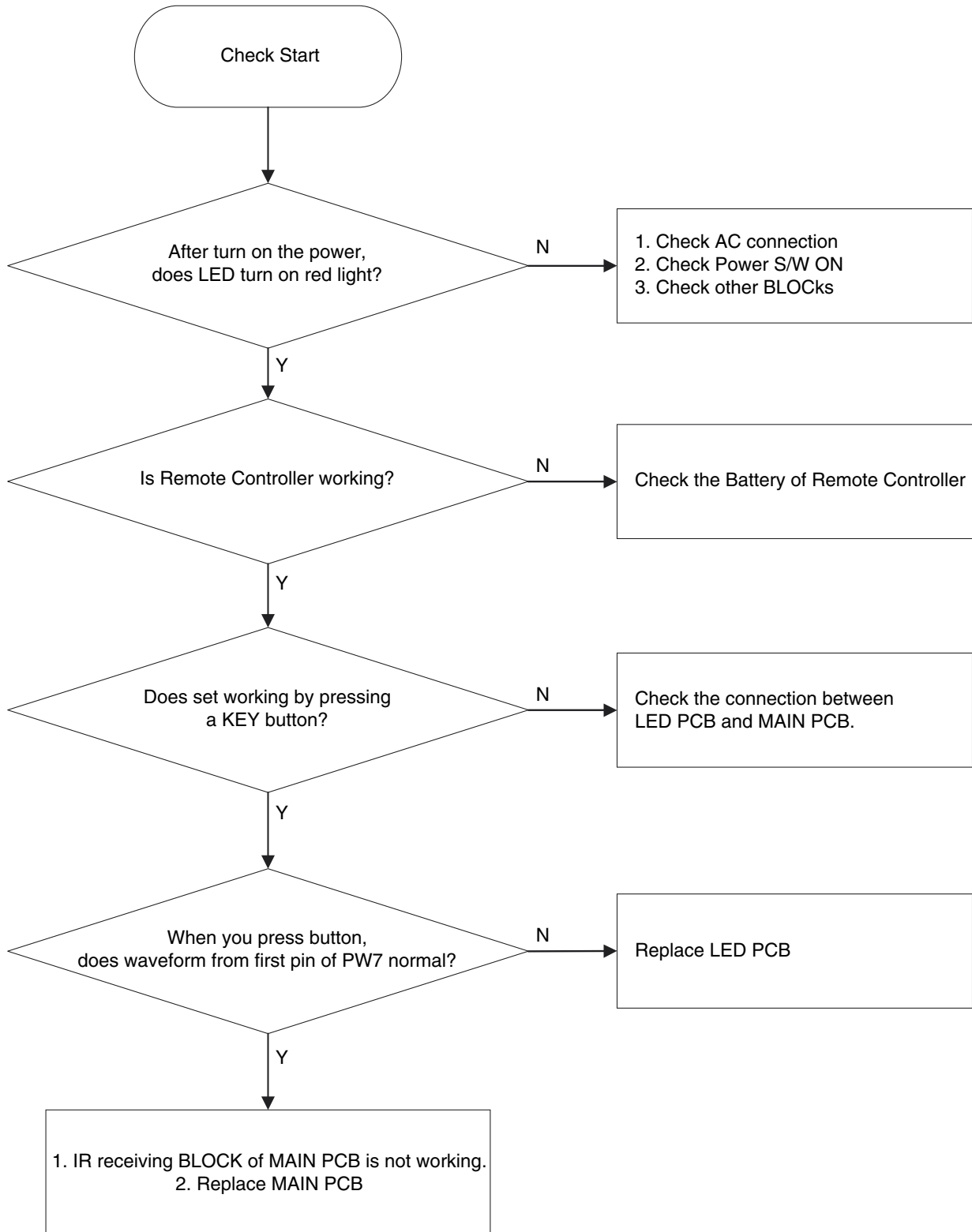

A. Check the connection between Main PCB and LED PCB.

B. Check the waveform first pin(IR) of PA912 to confirm IR operation.

If IR is not working, replace the LED PCB.

Main PCBs Trouble Diagnosis

Remote control signal (First pin of PA912)

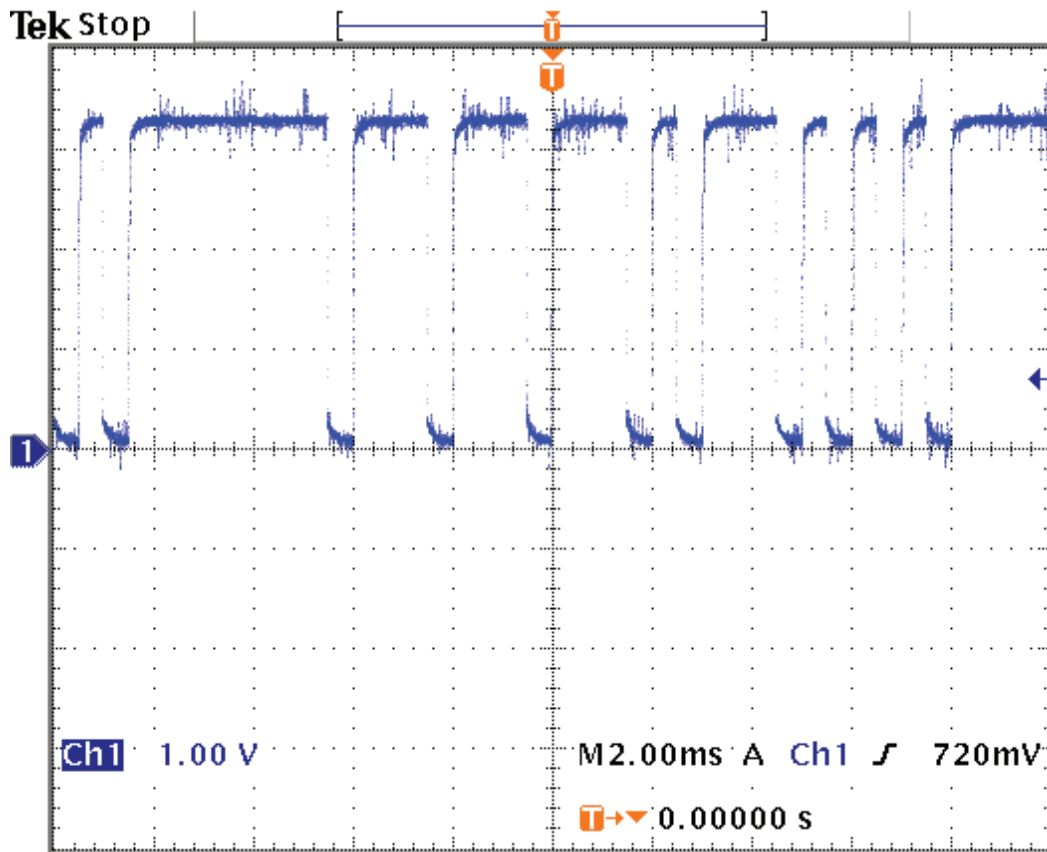

Main PCBs Trouble Diagnosis

7-2. POWER PCB

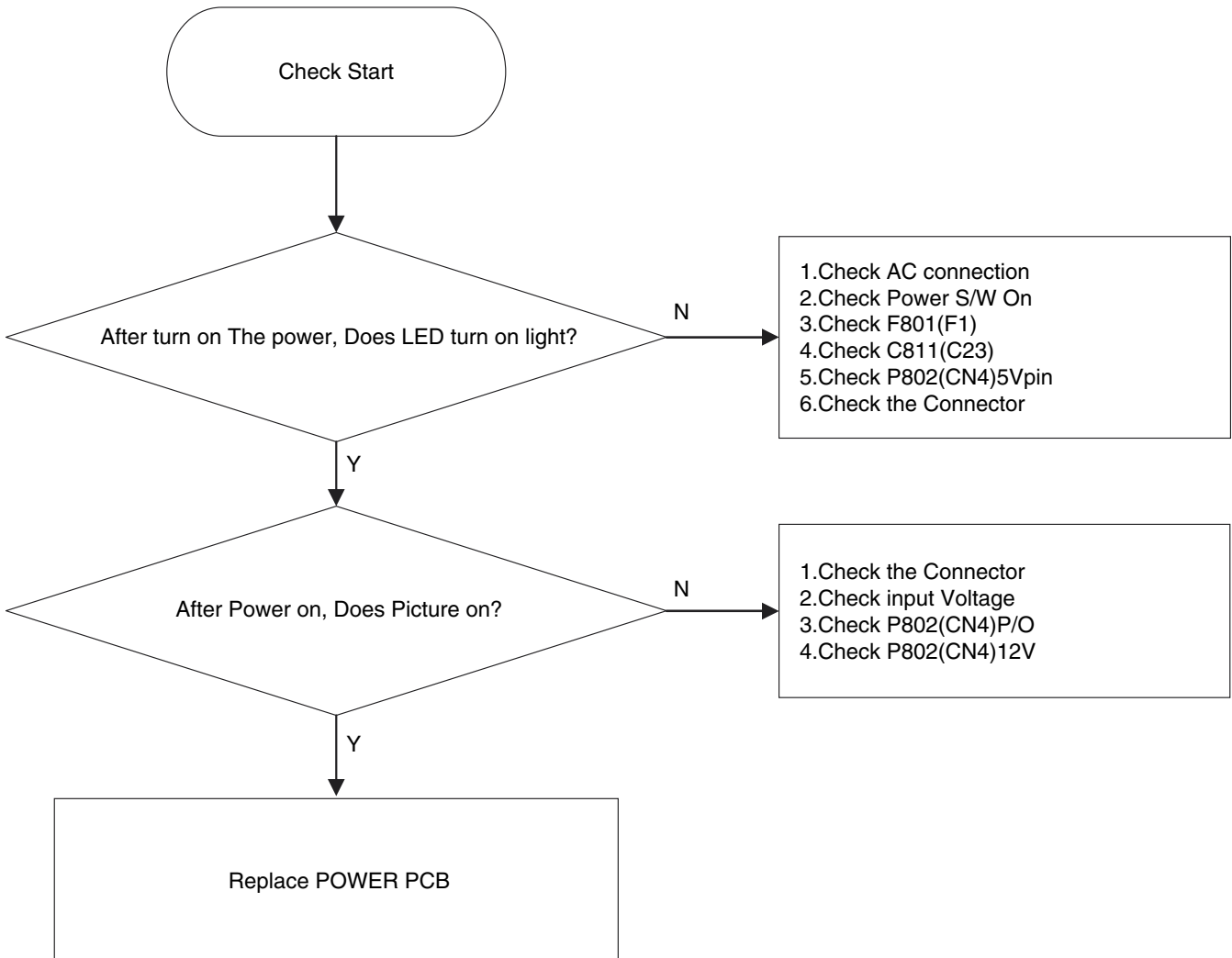

- 7-2-1. Check AC connection is correct.
- 7-2-2. Check AC Switch ON.
- 7-2-3. Check F801(FUSE) is working.
- 7-2-4. Check all wafer output is correct.

8. Trouble Diagnosis

8-1. Facts you must know when trouble Diagnosing or Repairing.

- A. Trouble diagnosing and repairing of set mean find out which PCBs or blocks are not working and replace them with new PCBs. Repairing the broken PCBs are not necessary. Keep the broken PCBs and return them to service center or R&D center.
- B. This TROUBLE DIAGNOSIS list only contains representative and simple PCB trouble diagnosis and Module Exchange method. Therefore, if you find Sets that are difficult to diagnosis or to repair, contact R&D center.
- C. Basic TROUBLE DIAGNOSIS process.

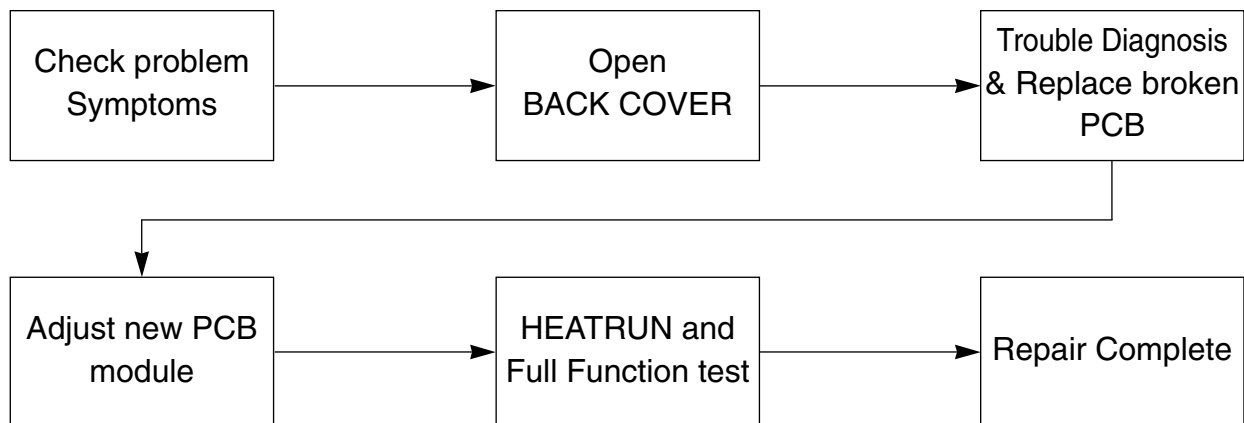

Note: HEATRUN is conducted for at least 30 minutes with input TEST PATTERN FULL WHITE

D. Required equipments for trouble diagnosis

- Digital Multimeter

User Mode: measure DC VOLTAGE, DIODE VOLTAGE, SHORT/OPEN TEST

- Screwdriver or electric screwdriver, plastic adjusting tool
- Oscilloscope(for detailed examination only)

E. Each BLOCK operations explained in this manual include oscilloscope waveforms, but these are for reference only and utilizing them to repair PCBs is not necessary.

F. Before replacing PCBs, you MUST turn off the AC switch.

G. After replacing POWER, MAIN and SUB PCB, extra adjustment might be needed. (Refer to 6. Adjusting Method)

H. After the set is repaired, leave BACK COVER open for followings. Run HEATRUN for at least 30 minutes by displaying TEST PATTERN(Full White) of SERVICE MODE(Refer to Service Manual, 5. Service Mode). Check the screen conditions and basic functions. (Remote Controller operation etc.)

I. After BACK COVER is closed, redo HEATRUN for at least one hour with Full White input using TEST PATTERN of SERVICE MODE. Check the screen conditions and basic functions.

Trouble Diagnosis

8-2. Typical Symptoms of PCBs problem or bad connection

A. Symptom of initial latch up

- Define initial latch up : When turn on the power, both LEDs light up red and TV is not working.
- Repairing method : This is typical symptom when ROM(ICU3) is incorrectly connected at socket. So if you find this symptom, you must try to that ROM(ICU3) and socket have correct contact.
- As this method, TV set is not repaired, replace MAIN PCB.

B. Symptom of No image when LED and Back Light are working.

- Define No image : LED and BACK LIGHT of panel are correctly working but any image does not display.
- Repairing method : This is typical symptom when LVDS cable incorrectly connects. So if you find this symptom, check LVDS connection.
- As this method, TV set is not repaired, replace Main or Sub PCB.

C. Representative Symptom caused by bad Connection between PCBs

- => Note: Dust or extraneous material may cause bad connections. Most of the time, applying soft brush, AIR FRESHER, or breath to clean dust or extraneous materials can solve it. And then reassemble the Connector.

9. Structure of LCD Set

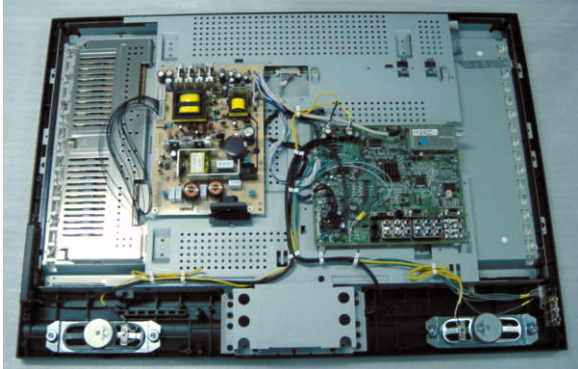
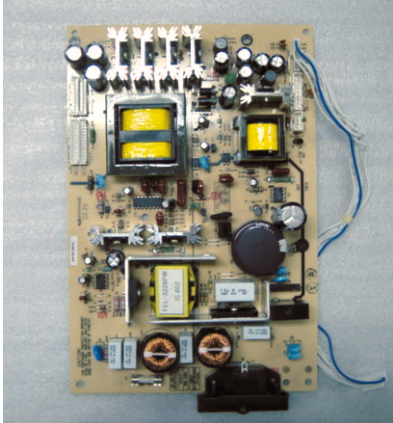
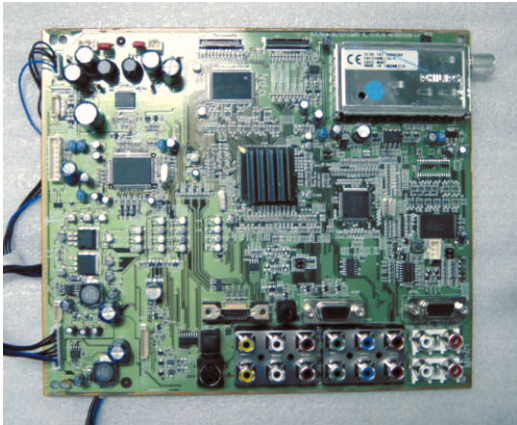
COMPONENT	PICTURE	REMARK
LCD PANET		
ALL CONNECTOR CONNECTION		
POWER BOARD		
MAIN BOARD		

Structure of LCD Set

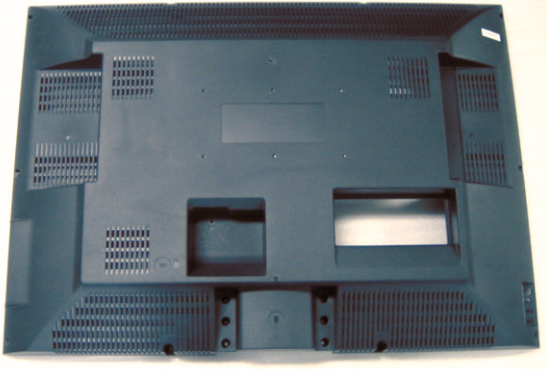
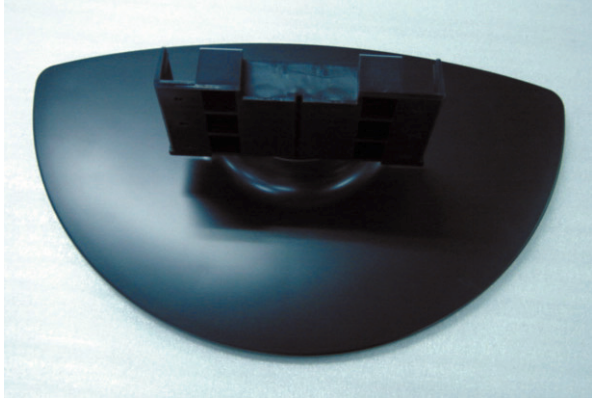
COMPONENT	PICTURE	REMARK
FRONT MASK	 A black plastic front mask for an LCD set, featuring a large rectangular opening in the center for the screen. The mask has a slightly curved bottom edge and a small notch at the very bottom center.	
BACK COVER	 The back cover of the LCD set, a dark grey or black plastic component. It features a complex design with multiple ventilation grilles, a central rectangular cutout, and two larger rectangular openings on the right side. The cover is designed to fit snugly behind the LCD panel.	
STAND	 A black plastic stand for the LCD set. It has a wide, curved base and a central support structure that holds the LCD panel in an upright position. The stand is designed to be stable and adjustable.	

10. EXPLODED VIEW

DLP-26C2

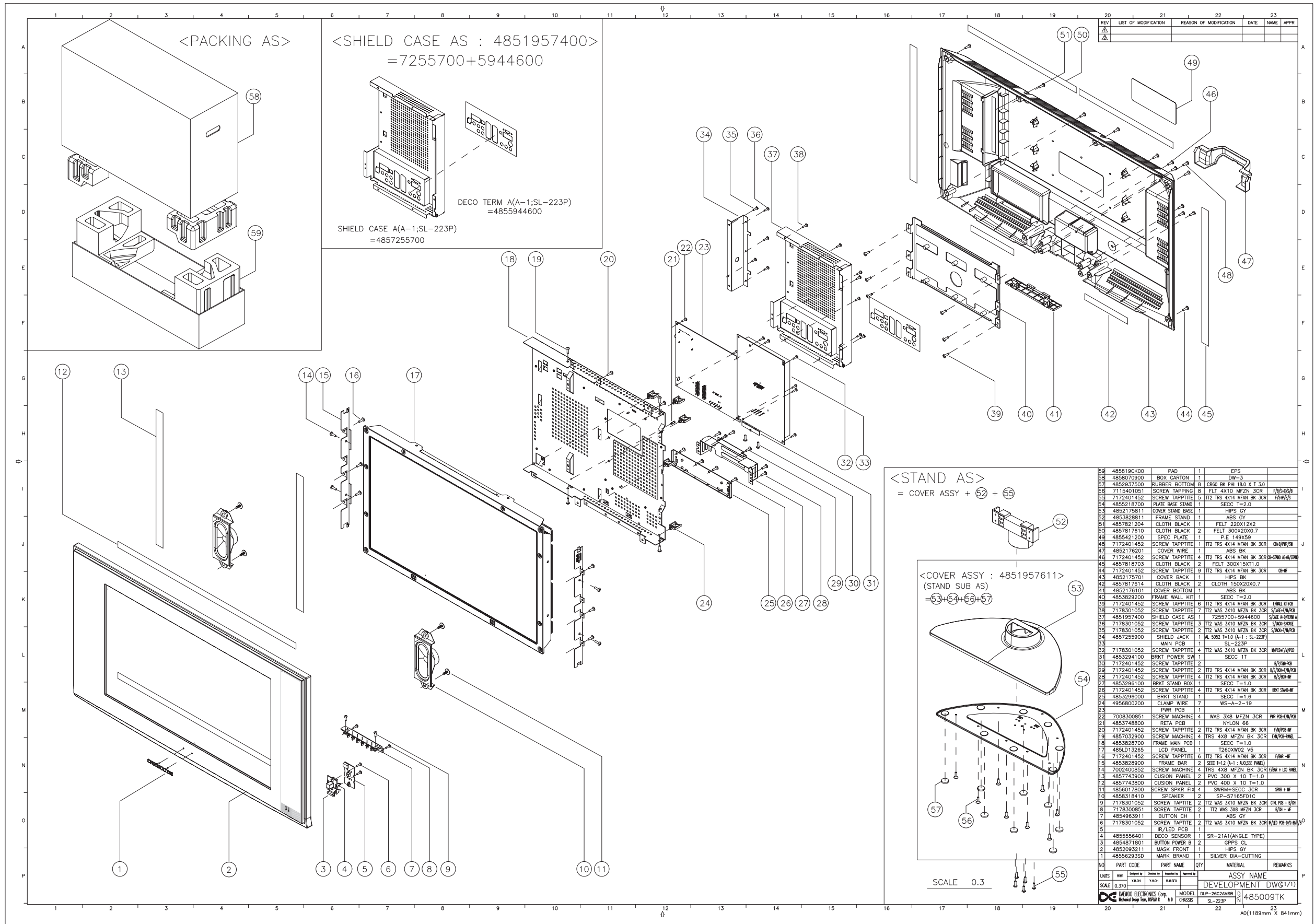

EXPLODED VIEW

DLP-26C3

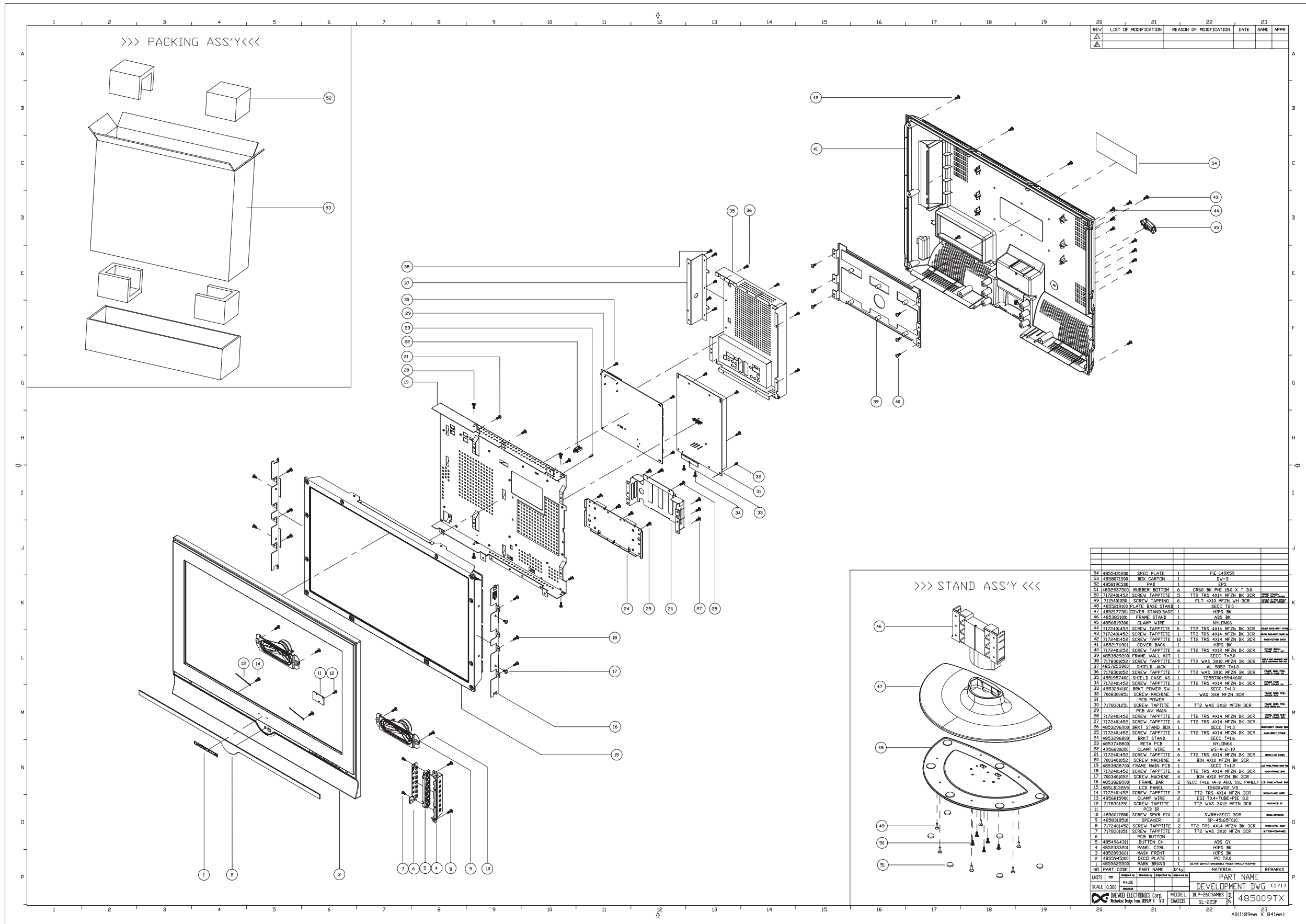

EXPLODED VIEW

DLP-32C2

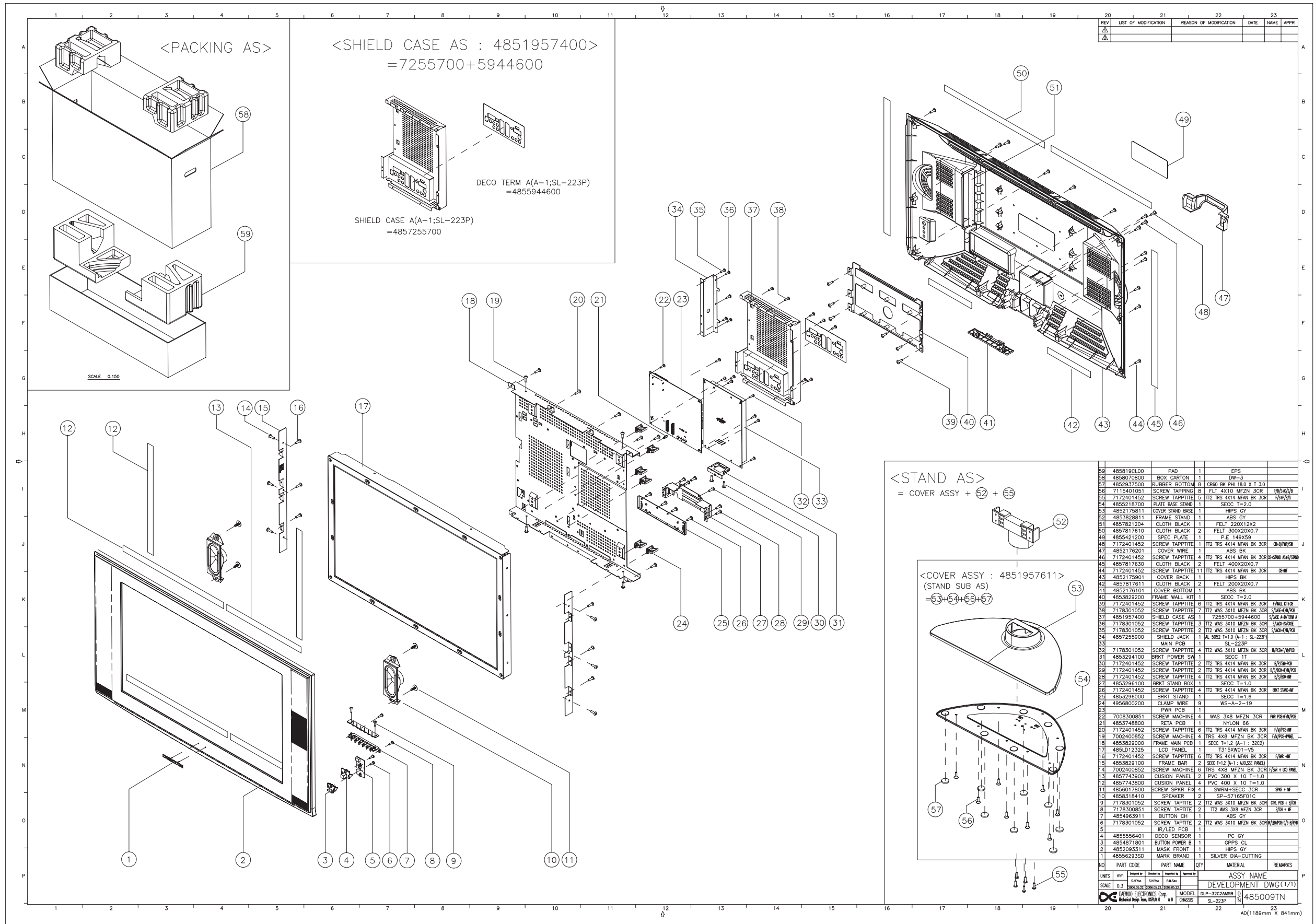

EXPLODED VIEW

DLP-32C3

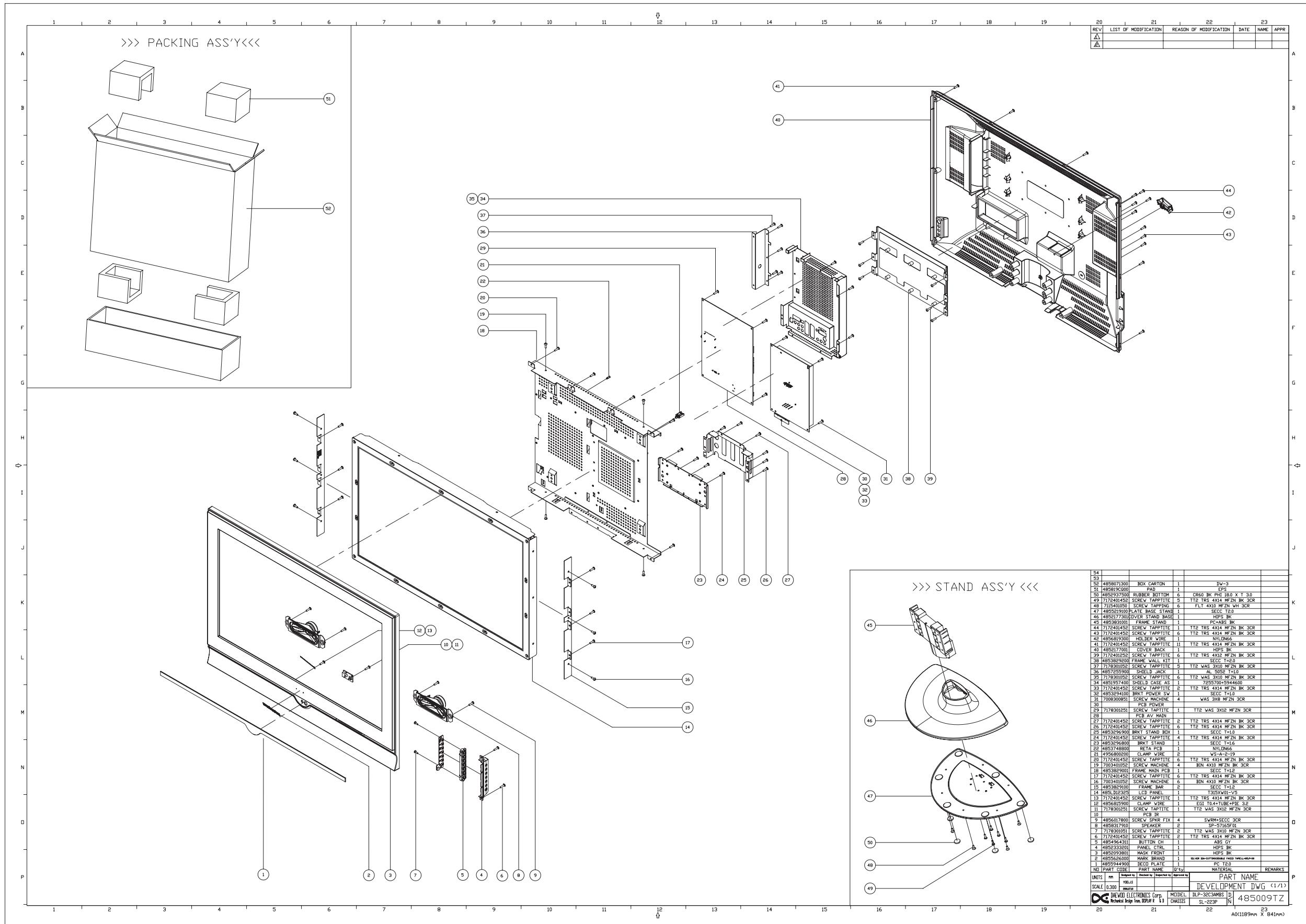

EXPLODED VIEW

DLP-37C3

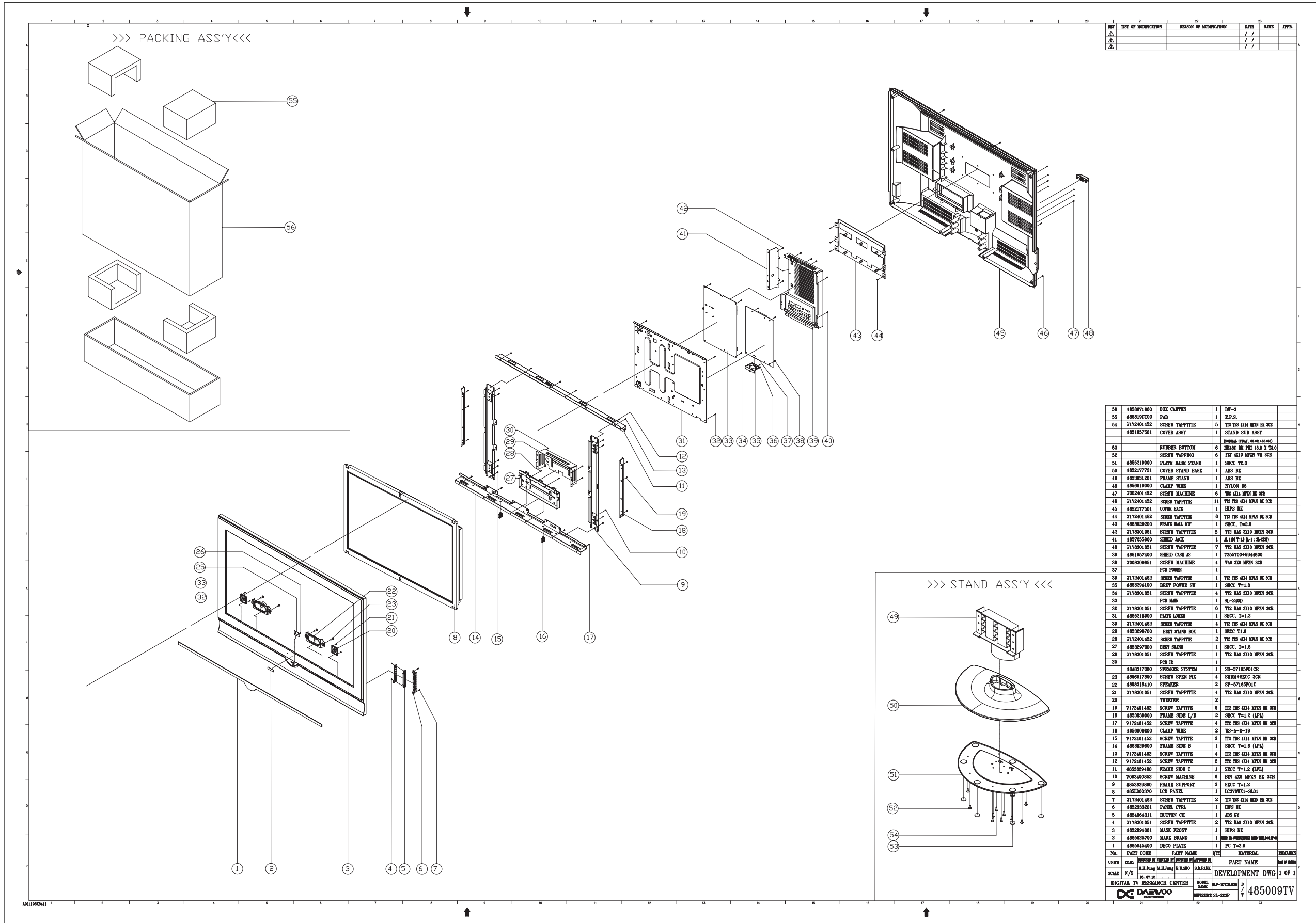

REV	LIST OF MODIFICATION	REASON OF MODIFICATION	DATE	NAME	APPR.
△			/ /		
△			/ /		
△			/ /		

56	4850071800	BOX CARTON	1	DR-3	
55	485014700	FOAM	1	Z.F.S.	
54	7172401452	SCREEN TAP/TITE	5	TYE TIS 414 MPX BK SCR	
	4851907501	COVER ASSY	1	STAND SUB ASSY	
				(FORMAL PART. NOT RELEASED)	
53		BUBBER BOTTOM	6	BRAC BK PH 1&O I TLO	
52		SCREEN TAPPING	6	PLT 4X10 MPX WH SCR	
51	4855219000	PLATE BASE STAND	1	SBOC T2.0	
50	4852177721	COVER STAND BASE	1	ABS BK	
49	4855851801	FRAME STAND	1	ABS BK	
48	4850819200	CLAMP WIRE	1	NYLON 66	
47	7002401452	SCREEN MACHINR	6	TYE 414 MPX BK SCR	
46	7172401452	SCREEN TAP/TITE	11	TYE TIS 414 MPX BK SCR	
45	4852177521	COVER BACK	1	HIPS BK	
44	7172401452	SCREEN TAP/TITE	6	TYE TIS 414 MPX BK SCR	
43	4853829200	FRAME WALL KIT	1	SBOC, T=2.0	
42	7172401451	SCREEN TAP/TITE	5	TYE WAS 3X10 MPX SCR	
41	4877550500	SHIELD JACK	1	R. IWB T10 (H-I, B-CMP)	
40	7172401451	SCREEN TAP/TITE	7	TYE WAS 3X10 MPX SCR	
39	4851907400	SHIELD CASE AS	1	T205703-0044800	
38	7009006051	SCREEN MACHINR	4	WAS 3X3 MPX SCR	
37		PCB POWER	1		
36	7172401452	SCREEN TAP/TITE	1	TYE TIS 414 MPX BK SCR	
35	4853294100	BRKT POWER SW	1	SBOC T=1.0	
34	7172401451	SCREEN TAP/TITE	4	TYE WAS 3X10 MPX SCR	
33		PCB MAIN	1	SL-2410	
32	7172401451	SCREEN TAP/TITE	6	TYE WAS 3X10 MPX SCR	
31	4855216800	PLATE LOWER	1	SBOC, T=1.2	
30	7172401452	SCREEN TAP/TITE	4	TYE TIS 414 MPX BK SCR	
29	4853297000	BRKT STAND BOX	1	SBOC T1.0	
28	7172401452	SCREEN TAP/TITE	2	TYE TIS 414 MPX BK SCR	
27	4853297000	BRKT STAND	1	SBOC, T=1.8	
26	7172401451	SCREEN TAP/TITE	1	TYE WAS 3X10 MPX SCR	
25		PCB B	1		
24	48A3170900	SPEAKER SYSTEM	1	SP-57160P1CR	
23	4850017800	SCREEN SPEER FIX	4	SPRM-SBOC SCR	
22	4850018410	SPEAKER	2	SP-57160P1C	
21	7172401451	SCREEN TAP/TITE	4	TYE WAS 3X10 MPX SCR	
20		TWEETER	2		
19	7172401452	SCREEN TAP/TITE	8	TYE TIS 414 MPX BK SCR	
18	4853830000	FRAME SIDE L/R	2	SBOC T=1.2 (LPL)	
17	7172401452	SCREEN TAP/TITE	4	TYE TIS 414 MPX BK SCR	
16	4850806200	CLAMP WIRE	2	WS-1-2-18	
15	7172401452	SCREEN TAP/TITE	2	TYE TIS 414 MPX BK SCR	
14	4853830000	FRAME SIDE B	1	SBOC T=1.8 (LPL)	
13	7172401452	SCREEN TAP/TITE	4	TYE TIS 414 MPX BK SCR	
12	7172401452	SCREEN TAP/TITE	2	TYE TIS 414 MPX BK SCR	
11	4853830000	FRAME SIDE T	1	SBOC T=1.2 (LPL)	
10	7005400802	SCREEN MACHINR	8	SHN 433 MPX BK SCR	
9	4855209000	FRAME SUPPORT	2	SBOC T=1.2	
8	4852400370	LCD PANEL	1	LC370WV1-SL01	
7	7172401452	SCREEN TAP/TITE	2	TYE TIS 414 MPX BK SCR	
6	4852333201	PANEL CTRL	1	HIPS BK	
5	4854064311	BUTTON CH	1	ABS GR	
4	7172401451	SCREEN TAP/TITE	2	TYE WAS 3X10 MPX SCR	
3	4855904001	MASK FRONT	1	HIPS BK	
2	4855625700	MARK BRAND	1	SHN B-COMMON BRND WFL-012-M	
1	4855045400	DECO PLATE	1	PC T=2.0	
No.	PART CODE	PART NAME	QTY	MATERIAL	REMARKS
UNIT	mm	REVISION #1 CHECK #2 REVISION #3 APPROV #1		PART NAME	REV # NONE
SCALE	N/S	M.E.Park M.E.Park B.E.SHO S.D.PARK		DEVELOPMENT DWG	1 OF 1
DIGITAL TV RESEARCH CENTER		NAME	REP-SPC/ASMB		
DAEWOO		REFERENCE	SL-233P		485009TV

EXPLODED VIEW

DLP-42C1

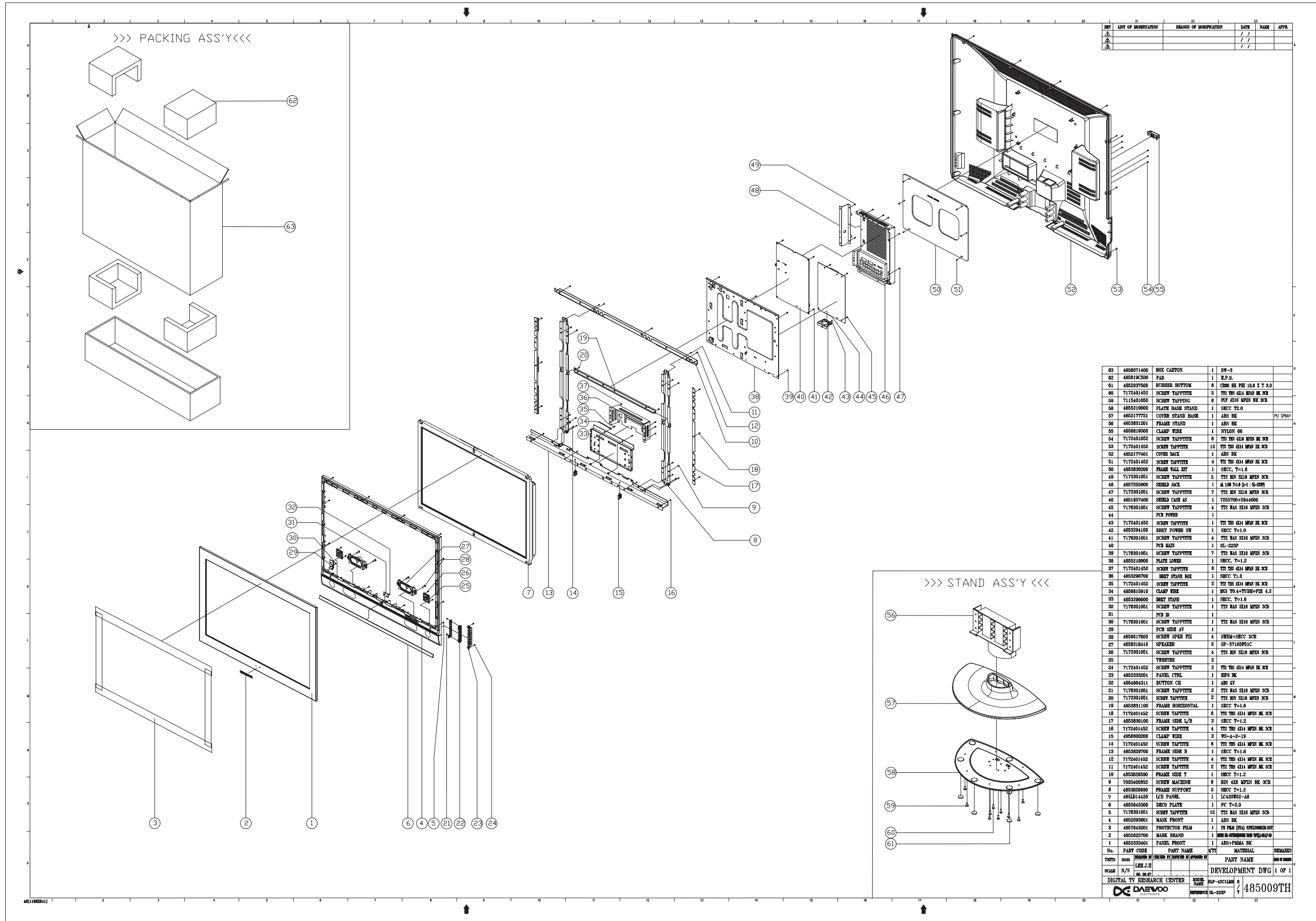

11. Part List

DLP-26C3

LOC	PART CODE	PART NAME	DESCRIPTION	REMARK
ZZ100	48B5454D06	TRANSMITTER REMOCON	R-54D06 (AAA)	
ZZ110	PTACPWG151	ACCESSORY AS	DLP-26C3AMBS	
60	4850Q01210	BATTERY	LR03 AAA ALKALINE	
M212	4852176101	COVER BOTTOM	ABS BK	
M681	4856819300	CLAMP WIRE	NYLON 66	
M821	4858213803	BAG INSTRUCTION	L.D.P.E.TO.05X250X400(+20)	
M861	48586210E1	MANUAL INSTRUCTION	ENGLISH	
P801A	48598DM000	CORD POWER AS	EU LP-33+LS-60L=2.0M(LF)	
ZZ120	PTBCSHG149	COVER BACK AS	DLT-26C3AMBS	
M211	4852176901	COVER BACK	HIPS BK	
M211A	7172401452	SCREW TAPPTITE	TT2 TRS 4X14 MFZN BK 3CR	
M211B	7172401452	SCREW TAPPTITE	TT2 TRS 4X14 MFZN BK 3CR	
M322	4853829200	FRAME WALL KIT	SECC T=2.0	
M322A	7172401452	SCREW TAPPTITE	TT2 TRS 4X14 MFZN BK 3CR	
ZZ130	PTPKCPG146	PACKING AS	DLX-26C3AMBS	
M681	4856812400	BAND PP AUTO	T1.1XW17MMXL770M	
M801	4858071500	BOX CARTON	DW-3	
M811	485819CS00	PAD	EPS	
M822	4858215701	BAG P.E	PE FOAM 10.5x1050x950	
ZZ140	PTCACAG151	CABINET AS	DLP-26C3AMBS	
M191	4851957400	SHIELD CASE AS	7255700+5944600	
M201C	4856815900	CLAMP WIRE	EGI T0.4+TUBE+PIE 3.2	
M201D	7173301052	SCREW TAPPTITE	TT2 BIN 3X10 MFZN BK 3CR	
M321	4853296800	BRKT STAND	SECC T1.6	
M321A	7172401452	SCREW TAPPTITE	TT2 TRS 4X14 MFZN BK 3CR	
M322	4853296900	BRKT STAND BOX	SECC T1.0	
M322A	7172401452	SCREW TAPPTITE	TT2 TRS 4X14 MFZN BK 3CR	
M381C	7172401452	SCREW TAPPTITE	TT2 TRS 4X14 MFZN BK 3CR	
M381G	7003401052	SCREW MACHINE	BIN 4X10 MFZN BK 3CR	
M383	4853828900	FRAME BAR	SECC T=1.2 (A-1 : AUO,SSE PANEL)	
M383A	7003401052	SCREW MACHINE	BIN 4X10 MFZN BK 3CR	
M383B	7172401652	SCREW TAPPTITE	TT2 TRS 4X16 MFZN BK 3CR	
M541	4855421200	SPEC PLATE	P.E 149X59	
M721A	7173301052	SCREW TAPPTITE	TT2 BIN 3X10 MFZN BK 3CR	
M723	4857255900	SHIELD JACK	AL 1100 T=1.0 (A-1 : SL-223P)	
M723A	7173301052	SCREW TAPPTITE	TT2 BIN 3X10 MFZN BK 3CR	
M723B	7173301052	SCREW TAPPTITE	TT2 BIN 3X10 MFZN BK 3CR	
MK625	4850K01700	CORE FERRITE	BNF-1130	
P520A	4859004160	CABLE LVDS	1001-31FC-N-FH10002-30-3212APSB-300	
P803B	4850714N06	CONNECTOR	20022HS-14S+SMH200-14P+ULW=300	
V901	485LD13265	LCD PANEL	T260XW02 V5	
ZZ200	PTFMSJG146	MASK FRONT AS	DLX-26C3AMBS	
M201	4852093601	MASK FRONT	HIPS BK	
M561	4855625500	MARK BRAND	SILVER DIA-CUTTING (DOUBLE FACED TAPE), L=80, P=30	
M591	4855945100	DECO PLATE	PC T2.0	
ZZ210	PTSPPWG151	SPEAKER AS	DLP-26C3AMBS	
P625	4850702N24	CONNECTOR	SMH250-02+YRT205+YRT110+USW=1000	
P626	4850703N42	CONNECTOR	SMH250-03+YRT205+YRT110+USW=1000	
SP01	4858318510	SPEAKER	SP-45165F01C	
SP01A	4858017800	SCREW SPKR FIX	SWRM+SECC 3CR	
SP02	4858318510	SPEAKER	SP-45165F01C	
SP02A	4858017800	SCREW SPKR FIX	SWRM+SECC 3CR	
ZZ250	PTSNSWG118	STAND AS	DL2-32C1SMR	
M213	4852177301	COVER STAND BASE	HIPS BK	
M383	4853831001	FRAME STAND	ABS BK	
M383A	7172401452	SCREW TAPPTITE	TT2 TRS 4X14 MFZN BK 3CR	
M521	4855219100	PLATE BASE STAND	SECC T2.0	
M521A	7115401051	SCREW TAPPING	FLT 4X10 MFZN 3CR	
M521C	4852937500	RUBBER BOTTOM	CR60 BK PHI 18.0 X T 3.0	
ZZ300	PTDGMGS117	PCB DIGITAL MANUAL AS	DLP-26C2AMBS	
100	2193110012	SOLDER WIRE	SAC3000 ϕ 3.0MM (LFA3C0-W3.0)	
200	2193110024	SOLDER WIRE	SAC3005 ϕ 1.6MM (LFA3-107-W1.6)	
300	2291050623	FLUX SOLDER LF	SV-PBF-304P(0.823)	
400	2291050312	FLUX SOLVENT	S-3000	
C216	CEXF1C471E	C ELECTRO	16V RM 470MF (8X11.5) TP	
C255	CEXF1C102V	C ELECTRO	16V RSS 1000MF (10X20) TP	
C267	CEXF1C102V	C ELECTRO	16V RSS 1000MF (10X20) TP	

LOC	PART CODE	PART NAME	DESCRIPTION	REMARK
C638	CEXF1H471V	C ELECTRO	50V RSS 470MF (13X20) TP	
C681	CEXF1E331V	C ELECTRO	25V RSS 330MF (10X12.5)TP	
C682	CEXF1E331V	C ELECTRO	25V RSS 330MF (10X12.5)TP	
C683	CEXF1E331V	C ELECTRO	25V RSS 330MF (10X12.5)TP	
C684	CEXF1E331V	C ELECTRO	25V RSS 330MF (10X12.5)TP	
HS505	4857032501	HEAT SINK	AL EX BK L=26	
IC703	124LC32A-P	IC EEPROM	24LC32A-I/P 32K 8 PIN DIP STICK	
JP201	4959200160	CONN D-SUB	SHF-015-B111-22/BR2-J0.6	
JP205	4959102340	JACK PHONE	YKB21-5157	
JP207	4859112950	JACK SCART	DSSM-0378 STR	
JP208	4859112950	JACK SCART	DSSM-0378 STR	
JP209	4859105340	JACK S-VHS	DSW-10 (STRAIGHT)	
JP210	4859117450	JACK PIN	DPSS-0173S	
JP211	4859117550	JACK PIN	DPSE-0375S	
JP603	97P6316100	JACK HEAD PHONE	DHSE-9959	
JP604	4859201170	CONN OPTICAL SENSOR	OJ107A-T050-SHS	
JP705	4859201460	CONN D-SUB 9P	SHRA0209011	
L606	58C0000166	COIL CHOKE	CH-220N	
L610	58C0000166	COIL CHOKE	CH-220N	
M321	4853294100	BRKT POWER SW	SECC 1T	
M321A	7172401452	SCREW TAPPTITE	TT2 TRS 4X14 MFZN BK 3CR	
M381	4853828700	FRAME MAIN PCB	SECC T=1.0	
M381D	7178301052	SCREW TAPPTITE	TT2 WAS 3X10 MFZN BK 3CR	
M381E	7008300851	SCREW MACHINE	WAS 3X8 MFZN 3CR	
M381F	4956800200	CLAMP WIRE	WS-A-2-19	
M381H	4853748800	RETA PCB	NYLON 66	
P540	4859295420	CONN WAFER	4602-04MV2-60-1 PLUG 4P ST	
P625A	4959240520	CONN WAFER	SMW250-02	
P626A	4859284420	CONN WAFER	SMW250-03	
P701	4859295420	CONN WAFER	4602-04MV2-60-1 PLUG 4P ST	
P702	4859295420	CONN WAFER	4602-04MV2-60-1 PLUG 4P ST	
P705	485923162S	CONN WAFER	YW025-03 (STICK)	
P802A	4850708S28	CONNECTOR	YH025-08+YBNH250-08+ULW=550	
P803A	4850704S62	CONNECTOR	YH025-04+YBNH250-04+ULW=150	
P804A	4859235120	CONN WAFER	YW025-08	
TU101	4859728530	TUNER VARACTOR	FQ1216MEI/H-5 (HORI/DIN)	
X401	5XJ28R32GE	CRYSTAL QUARTZ	HC-49/S 28.322MHZ 30PPM 16PF	
X601	5XE18R432E	CRYSTAL QUARTZ	HC-49/U 18.43200MHZ 30PPM	
X701	5XE10R000E	CRYSTAL QUARTZ	HC-49/U 10.00000MHZ 30PPM	
ZZ200	PTDGJ2G117	PCB DIGITAL CHIP B AS	DLP-26C2AMBS	
CC147	HCBK103KBA	C CHIP CERA	50V X7R 0.01MF K 1608	
CC148	HCQK101JBA	C CHIP CERA	50V CH 100PF J 1608	
CC213	HCBK104KBA	C CHIP CERA	50V X7R 0.1MF K 1608	
CC234	HCBK104KBA	C CHIP CERA	50V X7R 0.1MF K 1608	
CC243	HCBK103KBA	C CHIP CERA	50V X7R 0.01MF K 1608	
CC249	HCQK100JBA	C CHIP CERA	50V CH 10PF J 1608	
CC251	HCQK100JBA	C CHIP CERA	50V CH 10PF J 1608	
CC270	HCBK103KBA	C CHIP CERA	50V X7R 0.01MF K 1608	
CC277	HCBK102KBA	C CHIP CERA	50V X7R 1000PF K 1608	
CC283	HCQK331JBA	C CHIP CERA	50V CH 330PF J 1608	
CC285	HCQK331JBA	C CHIP CERA	50V CH 330PF J 1608	
CC288	HCBK104KBA	C CHIP CERA	50V X7R 0.1MF K 1608	
CC406	HCBK104KBA	C CHIP CERA	50V X7R 0.1MF K 1608	
CC407	HCBK104KBA	C CHIP CERA	50V X7R 0.1MF K 1608	
CC409	HCBK104KBA	C CHIP CERA	50V X7R 0.1MF K 1608	
CC412	HCBK472KBA	C CHIP CERA	50V X7R 4700PF K 1608	
CC413	HCBK104KBA	C CHIP CERA	50V X7R 0.1MF K 1608	
CC414	HCBK104KBA	C CHIP CERA	50V X7R 0.1MF K 1608	
CC415	HCBK103KBA	C CHIP CERA	50V X7R 0.01MF K 1608	
CC416	HCBK103KBA	C CHIP CERA	50V X7R 0.01MF K 1608	
CC417	HCBK103KBA	C CHIP CERA	50V X7R 0.01MF K 1608	
CC418	HCBK103KBA	C CHIP CERA	50V X7R 0.01MF K 1608	
CC419	HCBK103KBA	C CHIP CERA	50V X7R 0.01MF K 1608	
CC471	HCBK104KBA	C CHIP CERA	50V X7R 0.1MF K 1608	
CC472	HCBK104KBA	C CHIP CERA	50V X7R 0.01MF K 1608	
CC473	HCBK104KBA	C CHIP CERA	50V X7R 0.1MF K 1608	
CC474	HCBK104KBA	C CHIP CERA	50V X7R 0.1MF K 1608	
CC475	HCBK104KBA	C CHIP CERA	50V X7R 0.1MF K 1608	

Part List

LOC	PART CODE	PART NAME	DESCRIPTION	REMARK
CC476	HCBK104KBA	C CHIP CERA	50V X7R 0.1MF K 1608	
CC477	HCBK104KBA	C CHIP CERA	50V X7R 0.1MF K 1608	
CC478	HCBK104KBA	C CHIP CERA	50V X7R 0.1MF K 1608	
CC479	HCBK104KBA	C CHIP CERA	50V X7R 0.1MF K 1608	
CC480	HCBK104KBA	C CHIP CERA	50V X7R 0.1MF K 1608	
CC481	HCBK104KBA	C CHIP CERA	50V X7R 0.1MF K 1608	
CC482	HCBK104KBA	C CHIP CERA	50V X7R 0.1MF K 1608	
CC483	HCBK104KBA	C CHIP CERA	50V X7R 0.1MF K 1608	
CC484	HCBK104KBA	C CHIP CERA	50V X7R 0.1MF K 1608	
CC486	HCBK104KBA	C CHIP CERA	50V X7R 0.1MF K 1608	
CC487	HCBK104KBA	C CHIP CERA	50V X7R 0.1MF K 1608	
CC488	HCBK104KBA	C CHIP CERA	50V X7R 0.1MF K 1608	
CC489	HCBK104KBA	C CHIP CERA	50V X7R 0.1MF K 1608	
CC490	HCBK104KBA	C CHIP CERA	50V X7R 0.1MF K 1608	
CC491	HCBK104KBA	C CHIP CERA	50V X7R 0.1MF K 1608	
CC492	HCBK104KBA	C CHIP CERA	50V X7R 0.1MF K 1608	
CC493	HCBK104KBA	C CHIP CERA	50V X7R 0.1MF K 1608	
CC494	HCBK104KBA	C CHIP CERA	50V X7R 0.1MF K 1608	
CC495	HCBK104KBA	C CHIP CERA	50V X7R 0.1MF K 1608	
CC496	HCBK104KBA	C CHIP CERA	50V X7R 0.1MF K 1608	
CC497	HCBK104KBA	C CHIP CERA	50V X7R 0.1MF K 1608	
CC498	HCBK104KBA	C CHIP CERA	50V X7R 0.1MF K 1608	
CC499	HCBK104KBA	C CHIP CERA	50V X7R 0.1MF K 1608	
CC536	HCBK104KBA	C CHIP CERA	50V X7R 0.1MF K 1608	
CC537	HCBK104KBA	C CHIP CERA	50V X7R 0.1MF K 1608	
CC539	HCBK104KBA	C CHIP CERA	50V X7R 0.1MF K 1608	
CC540	HCBK104KBA	C CHIP CERA	50V X7R 0.1MF K 1608	
CC541	HCBK104KBA	C CHIP CERA	50V X7R 0.1MF K 1608	
CC542	HCBK104KBA	C CHIP CERA	50V X7R 0.1MF K 1608	
CC544	HCBK104KBA	C CHIP CERA	50V X7R 0.1MF K 1608	
CC545	HCBK272KBA	C CHIP CERA	50V X7R 2700PF K 1608	
CC546	HCBK104KBA	C CHIP CERA	50V X7R 0.1MF K 1608	
CC547	HCBK104KBA	C CHIP CERA	50V X7R 0.1MF K 1608	
CC548	HCBK104KBA	C CHIP CERA	50V X7R 0.1MF K 1608	
CC549	HCBK104KBA	C CHIP CERA	50V X7R 0.1MF K 1608	
CC550	HCBK104KBA	C CHIP CERA	50V X7R 0.1MF K 1608	
CC565	HCBK104KBA	C CHIP CERA	50V X7R 0.1MF K 1608	
CC588	HCBK104KBA	C CHIP CERA	50V X7R 0.1MF K 1608	
CC589	HCBK104KBA	C CHIP CERA	50V X7R 0.1MF K 1608	
CC590	HCBK104KBA	C CHIP CERA	50V X7R 0.1MF K 1608	
CC591	HCBK104KBA	C CHIP CERA	50V X7R 0.1MF K 1608	
CC592	HCBK104KBA	C CHIP CERA	50V X7R 0.1MF K 1608	
CC593	HCBK104KBA	C CHIP CERA	50V X7R 0.1MF K 1608	
CC594	HCBK104KBA	C CHIP CERA	50V X7R 0.1MF K 1608	
CC619	HCBK152KBA	C CHIP CERA	50V X7R 1500PF K 1608	
CC624	HCBK471KBA	C CHIP CERA	50V X7R 470PF K 1608	
CC626	HCBH224KBA	C CHIP CERA	25V X7R 0.22MF K 1608	
CC639	HCBK103KBA	C CHIP CERA	50V X7R 0.01MF K 1608	
CC661	HCBK104KBA	C CHIP CERA	50V X7R 0.1MF K 1608	
CC664	HCBK104KBA	C CHIP CERA	50V X7R 0.1MF K 1608	
CC666	HCBK104KBA	C CHIP CERA	50V X7R 0.1MF K 1608	
CC667	HCFK154ZBA	C CHIP CERA	Y5V 50V 0.15MF Z 1608	
CC668	HCBK104KBA	C CHIP CERA	50V X7R 0.1MF K 1608	
CC669	HCFK154ZBA	C CHIP CERA	Y5V 50V 0.15MF Z 1608	
CC685	HCF474ZBA	C CHIP CERA	Y5V 16V 0.47MF Z 1608	
CC687	HCF474ZBA	C CHIP CERA	Y5V 16V 0.47MF Z 1608	
DC213	DBAV99ML-B	DIODE CHIP	BAV99ML	
DC214	DBAV99ML-B	DIODE CHIP	BAV99ML	
DC215	DBAV99ML-B	DIODE CHIP	BAV99ML	
DC225	DBAV99ML-B	DIODE CHIP	BAV99ML	
DC228	DBAV99ML-B	DIODE CHIP	BAV99ML	
DC229	DBAV99ML-B	DIODE CHIP	BAV99ML	
DC230	DBAV99ML-B	DIODE CHIP	BAV99ML	
DC231	DBAV99ML-B	DIODE CHIP	BAV99ML	
DC232	DBAV99ML-B	DIODE CHIP	BAV99ML	
DC233	DBAV99ML-B	DIODE CHIP	BAV99ML	
DC234	DBAV99ML-B	DIODE CHIP	BAV99ML	
DC235	DBAV99ML-B	DIODE CHIP	BAV99ML	

LOC	PART CODE	PART NAME	DESCRIPTION	REMARK
DC236	DBAV99ML-B	DIODE CHIP	BAV99ML	
DC238	DBAV99ML-B	DIODE CHIP	BAV99ML	
DC239	DBAV99ML-B	DIODE CHIP	BAV99ML	
DC240	DBAV99ML-B	DIODE CHIP	BAV99ML	
DC241	DBAV99ML-B	DIODE CHIP	BAV99ML	
DC280	DBAV99ML-B	DIODE CHIP	BAV99ML	
DC281	DBAV99ML-B	DIODE CHIP	BAV99ML	
DC283	DBAV99ML-B	DIODE CHIP	BAV99ML	
LC207	HFF300B01A	F CHIP FERRITE BEAD	30 OHM UPB 1608	
LC209	HFF300B01A	F CHIP FERRITE BEAD	30 OHM UPB 1608	
LC217	HFF300B01A	F CHIP FERRITE BEAD	30 OHM UPB 1608	
LC218	HFF300B01A	F CHIP FERRITE BEAD	30 OHM UPB 1608	
LC219	HFF300B01A	F CHIP FERRITE BEAD	30 OHM UPB 1608	
LC221	HFF300B01A	F CHIP FERRITE BEAD	30 OHM UPB 1608	
LC222	HFF300B01A	F CHIP FERRITE BEAD	30 OHM UPB 1608	
LC224	HFF300B01A	F CHIP FERRITE BEAD	30 OHM UPB 1608	
LC225	HFF300B01A	F CHIP FERRITE BEAD	30 OHM UPB 1608	
QC601	T2SC2412KB	TR CHIP	2SC2412K-T146-BR	
RC211	HRFT750JBA	R CHIP	1/10 75 OHM J 1608	
RC217	HRFT750JBA	R CHIP	1/10 75 OHM J 1608	
RC218	HRFT102JBA	R CHIP	1/10 1K OHM J 1608	
RC219	HRFT750JBA	R CHIP	1/10 75 OHM J 1608	
RC220	HRFT750JBA	R CHIP	1/10 75 OHM J 1608	
RC221	HRFT750JBA	R CHIP	1/10 75 OHM J 1608	
RC222	HRFT274JBA	R CHIP	1/10 270K OHM J 1608	
RC223	HRFT104JBA	R CHIP	1/10 100K OHM J 1608	
RC237	HRFT274JBA	R CHIP	1/10 270K OHM J 1608	
RC238	HRFT104JBA	R CHIP	1/10 100K OHM J 1608	
RC248	HRFT750JBA	R CHIP	1/10 75 OHM J 1608	
RC251	HRFT750JBA	R CHIP	1/10 75 OHM J 1608	
RC252	HRFT750JBA	R CHIP	1/10 75 OHM J 1608	
RC254	HRFT103JBA	R CHIP	1/10 10K OHM J 1608	
RC255	HRFT103JBA	R CHIP	1/10 10K OHM J 1608	
RC256	HRFT102JBA	R CHIP	1/10 1K OHM J 1608	
RC288	HRFT473JBA	R CHIP	1/10 47K OHM J 1608	
RC290	HRFT000JBA	R CHIP	1/10 0 OHM J 1608	
RC292	HRFT000JBA	R CHIP	1/10 0 OHM J 1608	
RC295	HRFT000-BA	R CHIP	1/10 0 OHM 1608	
RC299	HRFT202JBA	R CHIP	1/10 2K OHM J 1608	
RC427	HRFT101JBA	R CHIP	1/10 100 OHM J 1608	
RC434	HRFT000JBA	R CHIP	1/10 0 OHM J 1608	
RC586	HRFT105JBA	R CHIP	1/10 1M OHM J 1608	
RC587	HRFT105JBA	R CHIP	1/10 1M OHM J 1608	
RC606	HRFT222JBA	R CHIP	1/10 2.2K OHM J 1608	
RC608	HRFT272JBA	R CHIP	1/10 2.7K OHM J 1608	
RC615	HRFT153JBA	R CHIP	1/10 15K OHM J 1608	
RC616	HRFT153JBA	R CHIP	1/10 15K OHM J 1608	
RC651	HRFT102JBA	R CHIP	1/10 1K OHM J 1608	
RC653	HRFT131JBA	R CHIP	1/10 130 OHM J 1608	
RC664	HRFT102JBA	R CHIP	1/10 1K OHM J 1608	
RC669	HRFT000JBA	R CHIP	1/10 0 OHM J 1608	
RC670	HRFT100JBA	R CHIP	1/10 10 OHM J 1608	
RC671	HRFT102JBA	R CHIP	1/10 1K OHM J 1608	
RC685	HRFT000-BA	R CHIP	1/10 0 OHM 1608	
RC687	HRFT000-BA	R CHIP	1/10 0 OHM 1608	
ZZ200	PTDGJ0G117	PCB DIGITAL RHU AS	DLP-26C2AMSB	
ZZ200	PTDGJBG117	PCB DIGITAL M-10 AS	DLP-26C2AMSB	
ZZ200	PTDGJRG117	PCB DIGITAL RADIAL AS	DLP-26C2AMSB	
C101	CEXF1C331V	C ELECTRO	16V RSS 330MF (8X11.5) TP	
C102	CEXF1C100V	C ELECTRO	16V RSS 100MF 4X7	
C103	CEXF1C101V	C ELECTRO	16V RSS 100MF (6.3X11) TP	
C104	CEXF1C101V	C ELECTRO	16V RSS 100MF (6.3X11) TP	
C266	CEXF1E470V	C ELECTRO	RSS 25V 47MF 5X11 P5.0 TA	
C277	CEXF1E470V	C ELECTRO	RSS 25V 47MF 5X11 P5.0 TA	
C508	CEXF1E470V	C ELECTRO	RSS 25V 47MF 5X11 P5.0 TA	
C521	CEXF1E470V	C ELECTRO	RSS 25V 47MF 5X11 P5.0 TA	
C522	CEXF1E470V	C ELECTRO	RSS 25V 47MF 5X11 P5.0 TA	
C551	CEXF1C220A	C ELECTRO	16V RSM 22MF (5X7)	

Part List

LOC	PART CODE	PART NAME	DESCRIPTION	REMARK
C552	CEXF1C220A	C ELECTRO	16V RSM 22MF (5X7)	
C555	CEXF1C220A	C ELECTRO	16V RSM 22MF (5X7)	
C563	CEXF1C470A	C ELECTRO	16V RSM 47MF (5X7) TP	
C585	CEXF1C100A	C ELECTRO	16V RSM 10MF 5X7	
C601	CEXF1C101V	C ELECTRO	16V RSS 100MF (6.3X11) TP	
C627	CEXF1C100A	C ELECTRO	16V RSM 10MF 5X7	
C628	CEXF1C101V	C ELECTRO	16V RSS 100MF (6.3X11) TP	
C631	CEXF1H479A	C ELECTRO	50V RSM 4.7MF 4X7	
C633	CEXF1C100A	C ELECTRO	16V RSM 10MF 5X7	
C641	CEXF1C100A	C ELECTRO	16V RSM 10MF 5X7	
C642	CEXF1C220A	C ELECTRO	16V RSM 22MF (5X7)	
C701	CEXF1C100A	C ELECTRO	16V RSM 10MF 5X7	
C761	CEXF1C220A	C ELECTRO	16V RSM 22MF (5X7)	
C764	CEXF1C100A	C ELECTRO	16V RSM 10MF 5X7	
CM677	CMXL1J474J	C MYLAR	63V MEU 0.47MF J	
CM678	CMXL1J474J	C MYLAR	63V MEU 0.47MF J	
L101	5CPX829K--	COIL PEAKING	8.2UH K (RADIAL)	
L102	5CPX829K--	COIL PEAKING	8.2UH K (RADIAL)	
L604	5CPX829K--	COIL PEAKING	8.2UH K (RADIAL)	
L605	5CPX829K--	COIL PEAKING	8.2UH K (RADIAL)	
L607	5CPX829K--	COIL PEAKING	8.2UH K (RADIAL)	
L608	5CPX829K--	COIL PEAKING	8.2UH K (RADIAL)	
L611	58C0000116	COIL BEAD	HC-3550R	
R601	RN01B102JS	R METAL FILM	1W 1K OHM J SMALL	
R602	RN01B102JS	R METAL FILM	1W 1K OHM J SMALL	
R603	RN01B102JS	R METAL FILM	1W 1K OHM J SMALL	
R604	RN01B102JS	R METAL FILM	1W 1K OHM J SMALL	
S701	5S50101Z90	SW TACT	THV502GDA	
ZZ200	PTDGJAG117	PCB DIGITAL AXIAL AS	DLP-26C2AMSB	
ZZ200	PTDGJ1G117	PCB DIGITAL CHIP A AS	DLP-26C2AMSB	
110	2193220010	SOLDER CREAM(PB-FREE)	LST309-M(SN+3.0AG/0.5CU)	
A001	4859813793	PCB DIGITAL	189X234 K4V	
CC128	HCBH104KBA	C CHIP CERA	25V X7R 0.1MF K 1608	
CC129	HCBH104KBA	C CHIP CERA	25V X7R 0.1MF K 1608	
CC215	HCBH104KBA	C CHIP CERA	25V X7R 0.1MF K 1608	
CC216	HCBH104KBA	C CHIP CERA	25V X7R 0.1MF K 1608	
CC226	HCBK152KBA	C CHIP CERA	50V X7R 1500PF K 1608	
CC228	HCBK152KBA	C CHIP CERA	50V X7R 1500PF K 1608	
CC250	HCQK100JBA	C CHIP CERA	50V CH 10PF J 1608	
CC267	HCBK103KBA	C CHIP CERA	50V X7R 0.01MF K 1608	
CC268	HCQK101JBA	C CHIP CERA	50V CH 100PF J 1608	
CC269	HCBK104KBA	C CHIP CERA	50V X7R 0.1MF K 1608	
CC278	HCBK102KBA	C CHIP CERA	50V X7R 1000PF K 1608	
CC279	HCBK102KBA	C CHIP CERA	50V X7R 1000PF K 1608	
CC280	HCBK102KBA	C CHIP CERA	50V X7R 1000PF K 1608	
CC284	HCQK331JBA	C CHIP CERA	50V CH 330PF J 1608	
CC286	HCQK331JBA	C CHIP CERA	50V CH 330PF J 1608	
CC289	HCBK103KBA	C CHIP CERA	50V X7R 0.01MF K 1608	
CC401	HCBK103KBA	C CHIP CERA	50V X7R 0.01MF K 1608	
CC402	HCBK103KBA	C CHIP CERA	50V X7R 0.01MF K 1608	
CC403	HCBK104KBA	C CHIP CERA	50V X7R 0.1MF K 1608	
CC408	HCBK104KBA	C CHIP CERA	50V X7R 0.1MF K 1608	
CC410	HCBK472KBA	C CHIP CERA	50V X7R 4700PF K 1608	
CC411	HCBK472KBA	C CHIP CERA	50V X7R 4700PF K 1608	
CC420	HCBK104KBA	C CHIP CERA	50V X7R 0.1MF K 1608	
CC421	HCBK104KBA	C CHIP CERA	50V X7R 0.1MF K 1608	
CC443	HCBK104KBA	C CHIP CERA	50V X7R 0.1MF K 1608	
CC444	HCBK104KBA	C CHIP CERA	50V X7R 0.1MF K 1608	
CC445	HCBK104KBA	C CHIP CERA	50V X7R 0.1MF K 1608	
CC446	HCBK104KBA	C CHIP CERA	50V X7R 0.1MF K 1608	
CC447	HCBK104KBA	C CHIP CERA	50V X7R 0.1MF K 1608	
CC448	HCBK104KBA	C CHIP CERA	50V X7R 0.1MF K 1608	
CC449	HCBK104KBA	C CHIP CERA	50V X7R 0.1MF K 1608	
CC450	HCBK104KBA	C CHIP CERA	50V X7R 0.1MF K 1608	
CC451	HCBK104KBA	C CHIP CERA	50V X7R 0.1MF K 1608	
CC452	HCBK104KBA	C CHIP CERA	50V X7R 0.1MF K 1608	
CC453	HCBK104KBA	C CHIP CERA	50V X7R 0.1MF K 1608	
CC454	HCBK104KBA	C CHIP CERA	50V X7R 0.1MF K 1608	

LOC	PART CODE	PART NAME	DESCRIPTION	REMARK
CC455	HCBK104KBA	C CHIP CERA	50V X7R 0.1MF K 1608	
CC456	HCBK104KBA	C CHIP CERA	50V X7R 0.1MF K 1608	
CC458	HCBK104KBA	C CHIP CERA	50V X7R 0.1MF K 1608	
CC459	HCBK104KBA	C CHIP CERA	50V X7R 0.1MF K 1608	
CC460	HCBK104KBA	C CHIP CERA	50V X7R 0.1MF K 1608	
CC462	HCBK104KBA	C CHIP CERA	50V X7R 0.1MF K 1608	
CC465	HCQK180JBA	C CHIP CERA	50V CH 18PF J 1608	
CC466	HCQK180JBA	C CHIP CERA	50V CH 18PF J 1608	
CC468	HCBK104KBA	C CHIP CERA	50V X7R 0.1MF K 1608	
CC485	HCBK103KBA	C CHIP CERA	50V X7R 0.01MF K 1608	
CC551	HCBH104KBA	C CHIP CERA	25V X7R 0.1MF K 1608	
CC552	HCBH104KBA	C CHIP CERA	25V X7R 0.1MF K 1608	
CC556	HCBH104KBA	C CHIP CERA	25V X7R 0.1MF K 1608	
CC557	HCBH104KBA	C CHIP CERA	25V X7R 0.1MF K 1608	
CC558	HCBH104KBA	C CHIP CERA	25V X7R 0.1MF K 1608	
CC561	HCBH104KBA	C CHIP CERA	25V X7R 0.1MF K 1608	
CC563	HCBH104KBA	C CHIP CERA	25V X7R 0.1MF K 1608	
CC564	HCBH104KBA	C CHIP CERA	25V X7R 0.1MF K 1608	
CC566	HCBK272KBA	C CHIP CERA	50V X7R 2700PF K 1608	
CC567	HCBH104KBA	C CHIP CERA	25V X7R 0.1MF K 1608	
CC569	HCBK103KBA	C CHIP CERA	50V X7R 0.01MF K 1608	
CC570	HCBK103KBA	C CHIP CERA	50V X7R 0.01MF K 1608	
CC577	HCBK104KBA	C CHIP CERA	50V X7R 0.1MF K 1608	
CC578	HCBH104KBA	C CHIP CERA	25V X7R 0.1MF K 1608	
CC584	HCBK104KBA	C CHIP CERA	50V X7R 0.1MF K 1608	
CC601	HCBK471KBA	C CHIP CERA	50V X7R 4700PF K 1608	
CC602	HCBK152KBA	C CHIP CERA	50V X7R 1500PF K 1608	
CC603	HCBH104KBA	C CHIP CERA	25V X7R 0.1MF K 1608	
CC604	HCBK682KBA	C CHIP CERA	50V X7R 6800PF K 1608	
CC605	HCBK682KBA	C CHIP CERA	50V X7R 6800PF K 1608	
CC606	HCBK682KBA	C CHIP CERA	50V X7R 6800PF K 1608	
CC607	HCBK682KBA	C CHIP CERA	50V X7R 6800PF K 1608	
CC608	HCBH104KBA	C CHIP CERA	25V X7R 0.1MF K 1608	
CC609	HCBH104KBA	C CHIP CERA	25V X7R 0.1MF K 1608	
CC610	HCBH224KBA	C CHIP CERA	25V X7R 0.22MF K 1608	
CC611	HCBH224KBA	C CHIP CERA	25V X7R 0.22MF K 1608	
CC612	HCBH224KBA	C CHIP CERA	25V X7R 0.22MF K 1608	
CC613	HCF334ZBA	C CHIP CERA	16V Y5V 0.33MF Z 1608	
CC614	HCBH224KBA	C CHIP CERA	25V X7R 0.22MF K 1608	
CC615	HCBH224KBA	C CHIP CERA	25V X7R 0.22MF K 1608	
CC616	HCBH104KBA	C CHIP CERA	25V X7R 0.1MF K 1608	
CC617	HCBH104KBA	C CHIP CERA	25V X7R 0.1MF K 1608	
CC620	HCQK509CBA	C CHIP CERA	50V CH 50PF C 1608	
CC621	HCQK509CBA	C CHIP CERA	50V CH 50PF C 1608	
CC622	HCQK681JBA	C CHIP CERA	50V CH 680PF J 1608	
CC623	HCQK681JBA	C CHIP CERA	50V CH 680PF J 1608	
CC625	HCBH224KBA	C CHIP CERA	25V X7R 0.22MF K 1608	
CC640	HCBK562KBA	C CHIP CERA	X7R 50V 5600PF K 1608	
CC641	HCBK562KBA	C CHIP CERA	X7R 50V 5600PF K 1608	
CC645	HCBK152KBA	C CHIP CERA	50V X7R 1500PF K 1608	
CC646	HCBK152KBA	C CHIP CERA	50V X7R 1500PF K 1608	
CC650	HCBH224KBA	C CHIP CERA	25V X7R 0.22MF K 1608	
CC651	HCBH224KBA	C CHIP CERA	25V X7R 0.22MF K 1608	
CC654	HCQK220JBA	C CHIP CERA	50V CH 22PF J 1608	
CC655	HCQK220JBA	C CHIP CERA	50V CH 22PF J 1608	
CC662	HCBK104KBA	C CHIP CERA	50V X7R 0.1MF K 1608	
CC665	HCBK104KBA	C CHIP CERA	50V X7R 0.1MF K 1608	
CC671	HCBH104KBA	C CHIP CERA	25V X7R 0.1MF K 1608	
CC672	HCBH104KBA	C CHIP CERA	25V X7R 0.1MF K 1608	
CC673	HCBH104KBA	C CHIP CERA	25V X7R 0.1MF K 1608	
CC675	HCQK331JBA	C CHIP CERA	50V CH 330PF J 1608	
CC676	HCBH104KBA	C CHIP CERA	25V X7R 0.1MF K 1608	
CC677	HCBH104KBA	C CHIP CERA	25V X7R 0.1MF K 1608	
CC678	HCQK331JBA	C CHIP CERA	50V CH 330PF J 1608	
CC679	HCBK103KBA	C CHIP CERA	50V X7R 0.01MF K 1608	
CC680	HCBH104KBA	C CHIP CERA	25V X7R 0.1MF K 1608	
CC681	HCBH104KBA	C CHIP CERA	25V X7R 0.1MF K 1608	
CC682	HCBH104KBA	C CHIP CERA	25V X7R 0.1MF K 1608	

Part List

LOC	PART CODE	PART NAME	DESCRIPTION	REMARK
CC686	HCF474ZBA	C CHIP CERA	Y5V 16V 0.47MF Z 1608	
CC701	HCQK200JBA	C CHIP CERA	50V CH 20PF J 1608	
CC702	HCQK200JBA	C CHIP CERA	50V CH 20PF J 1608	
CC703	HCQK101JBA	C CHIP CERA	50V CH 100PF J 1608	
CC704	HCBK104KBA	C CHIP CERA	50V X7R 0.1MF K 1608	
CC707	HCBK103KBA	C CHIP CERA	50V X7R 0.01MF K 1608	
CC747	HCBK104KBA	C CHIP CERA	50V X7R 0.1MF K 1608	
CC755	HCBK104KBA	C CHIP CERA	50V X7R 0.1MF K 1608	
CC756	HCBK104KBA	C CHIP CERA	50V X7R 0.1MF K 1608	
CC757	HCBK104KBA	C CHIP CERA	50V X7R 0.1MF K 1608	
CC758	HCBK104KBA	C CHIP CERA	50V X7R 0.1MF K 1608	
CC759	HCBK104KBA	C CHIP CERA	50V X7R 0.1MF K 1608	
CC760	HCBH104KBA	C CHIP CERA	25V X7R 0.1MF K 1608	
CC765	HCBH104KBA	C CHIP CERA	25V X7R 0.1MF K 1608	
CC767	HCBK104KBA	C CHIP CERA	50V X7R 0.1MF K 1608	
CC768	HCBK102KBA	C CHIP CERA	50V X7R 1000PF K 1608	
CC775	HCBK104KBA	C CHIP CERA	50V X7R 0.1MF K 1608	
CC776	HCBK102KBA	C CHIP CERA	50V X7R 1000PF K 1608	
CC777	HCBK104KBA	C CHIP CERA	50V X7R 0.1MF K 1608	
CC778	HCBK102KBA	C CHIP CERA	50V X7R 1000PF K 1608	
CE275	HCEJF211MC	C CHIP ELECTRO	16V 220MF CS 8010	
CE401	HCEJF100MC	C CHIP ELECTRO	16V 10MF MV 4052	
CE402	HCEJF100MC	C CHIP ELECTRO	16V 10MF MV 4052	
CE435	HCEJF100MC	C CHIP ELECTRO	16V 10MF MV 4052	
CE539	HCEJF100MC	C CHIP ELECTRO	16V 10MF MV 4052	
CE540	HCEJF100MC	C CHIP ELECTRO	16V 10MF MV 4052	
CE541	HCEJF100MC	C CHIP ELECTRO	16V 10MF MV 4052	
CE542	HCEJF100MC	C CHIP ELECTRO	16V 10MF MV 4052	
CE544	HCEJF100MC	C CHIP ELECTRO	16V 10MF MV 4052	
CE546	HCEJF100MC	C CHIP ELECTRO	16V 10MF MV 4052	
CE547	HCEJF100MC	C CHIP ELECTRO	16V 10MF MV 4052	
CE548	HCEJF100MC	C CHIP ELECTRO	16V 10MF MV 4052	
CE549	HCEJF100MC	C CHIP ELECTRO	16V 10MF MV 4052	
CE550	HCEJF100MC	C CHIP ELECTRO	16V 10MF MV 4052	
CE556	HCELF220MD	C CHIP ELECTRO	16V 22MF CM 4052	
CE557	HCELF220MD	C CHIP ELECTRO	16V 22MF CM 4052	
CE558	HCELF220MD	C CHIP ELECTRO	16V 22MF CM 4052	
CE559	HCELF220MD	C CHIP ELECTRO	16V 22MF CM 4052	
CE560	HCELF220MD	C CHIP ELECTRO	16V 22MF CM 4052	
CE561	HCELF220MD	C CHIP ELECTRO	16V 22MF CM 4052	
CE562	HCELF220MD	C CHIP ELECTRO	16V 22MF CM 4052	
CE564	HCELF220MD	C CHIP ELECTRO	16V 22MF CM 4052	
CE565	HCEJF100MC	C CHIP ELECTRO	16V 10MF MV 4052	
CE584	HCEJF100MC	C CHIP ELECTRO	16V 10MF MV 4052	
CE586	HCEJF100MC	C CHIP ELECTRO	16V 10MF MV 4052	
CE587	HCEJF100MC	C CHIP ELECTRO	16V 10MF MV 4052	
CE590	HCEJF100MC	C CHIP ELECTRO	16V 10MF MV 4052	
CE591	HCEJF100MC	C CHIP ELECTRO	16V 10MF MV 4052	
CE592	HCEJF100MC	C CHIP ELECTRO	16V 10MF MV 4052	
CE593	HCEJF100MC	C CHIP ELECTRO	16V 10MF MV 4052	
CE594	HCEJF100MC	C CHIP ELECTRO	16V 10MF MV 4052	
CE618	HCEEF101MC	C CHIP ELECTRO	MV 16V 100MF 6.3DX5.7H	
CE619	HCEEF101MC	C CHIP ELECTRO	MV 16V 100MF 6.3DX5.7H	
CE755	HCELF100MC	C CHIP ELECTRO	25V 10MF CM 4052	
DA501	D0514M----	DIODE ARRAY	RCLAMP0514M	
DA502	D0514M----	DIODE ARRAY	RCLAMP0514M	
DC221	DBAV99ML-B	DIODE CHIP	BAV99ML	
DC222	DBAV99ML-B	DIODE CHIP	BAV99ML	
DC223	DBAV99ML-B	DIODE CHIP	BAV99ML	
DC224	DBAV99ML-B	DIODE CHIP	BAV99ML	
DC226	DBAV99ML-B	DIODE CHIP	BAV99ML	
DC227	DBAV99ML-B	DIODE CHIP	BAV99ML	
DC277	DBAV99ML-B	DIODE CHIP	BAV99ML	
DC278	DBAV99ML-B	DIODE CHIP	BAV99ML	
DC279	DBAV99ML-B	DIODE CHIP	BAV99ML	
DC282	DBAV99ML-B	DIODE CHIP	BAV99ML	
DC291	DBAV99ML-B	DIODE CHIP	BAV99ML	
DC292	DBAV99ML-B	DIODE CHIP	BAV99ML	

LOC	PART CODE	PART NAME	DESCRIPTION	REMARK
DC293	DBAV99ML-B	DIODE CHIP	BAV99ML	
DC401	DMMBD1204B	DIODE CHIP	MMBD1204	
DC704	DMMBD1204B	DIODE CHIP	MMBD1204	
DC705	DMMBD1203B	DIODE CHIP	MMBD1203	
DC708	TBSS138-A	TR CHIP	BSS138	
DC709	TBSS138-A	TR CHIP	BSS138	
DZ204	DUMZ8R2T-B	DIODE CHIP ZENER	UMZ-8.2T (TAPING)	
DZ255	DSFPA73--	DIODE SCHOTTKY	SFPA-73	
DZ256	DSFPA73--	DIODE SCHOTTKY	SFPA-73	
DZ403	DUMZ8R2T-B	DIODE CHIP ZENER	UMZ-8.2T (TAPING)	
DZ703	DUMZ8R2T-B	DIODE CHIP ZENER	UMZ-8.2T (TAPING)	
DZ704	DUMZ8R2T-B	DIODE CHIP ZENER	UMZ-8.2T (TAPING)	
IC201	1K1A78L08C	IC CHIP REGULATOR	KIA78L08F	
IC202	1CD74HC53D	IC CHIP LOGIC	CD74HC4053M SOIC 16 REEL	
IC402	124LC22A-C	IC CHIP EEPROM	24LC22AT-1SN SOIC8 REEL	
IC501	1M74HC14RD	IC CHIP HEX-SCHMITT INVERTER	M74HC14RM13TR	
IC505	1SVPPX66-Q	IC CHIP VIDEO PROCESSOR	SVP-PX66(7266-LF)	
IC507	1085D2M25C	IC CHIP REGULATOR	LD1085D2M25	
IC508	1P1084K33D	IC CHIP REGULATOR	AP1084 33 TO-263-3L	
IC511	TFDS4953-C	FET CHIP	FDS4953 SO-8 -30V -5A REEL	
IC512	1MP1583-D	IC CHIP CONVERTER	MP1583DN	
IC513	1MP1583-D	IC CHIP CONVERTER	MP1583DN	
IC601	1MSP4610KQ	IC CHIP SOUND	MSP4610K	
IC602	1STA515W-D	IC CHIP AUDIO AMP	STA515W	
IC603	1TDA1308TC	IC CHIP HEADPHONE DRIVER	TDA1308T	
IC605	1K1A7027TB	IC CHIP RESET	KIA7027AT 2.7V TSM TYPE	
IC701	10620SPGPQ	IC CHIP MICRO PROCESSOR	M30620SPGP	
IC702	1ST232CD-Q	IC CHIP DRIVE	ST232CD	
IC704	1S29AL008Q	IC CHIP FLASH ROM	S29AL008D90TF1010 8M 48PIN TSOP TRAY	
IC707	1K1A7027TB	IC CHIP RESET	KIA7027AT 2.7V TSM TYPE	
IC711	1AP117E33C	IC CHIP REGULATOR	AP1117E33A 3.3V SOT-223	
IC766	1K1A7027TB	IC CHIP RESET	KIA7027AT 2.7V TSM TYPE	
IC901	1D263238FQ	IC CHIP DDR SDRAM	K4D263238F-UC50	
JP506	4859201360	CONN HDMI	51V019S-36WT-A1R	
LC201	HFF300B01A	F CHIP FERRITE BEAD	30 OHM UPB 1608	
LC202	HFF300B01A	F CHIP FERRITE BEAD	30 OHM UPB 1608	
LC205	HFF300B01A	F CHIP FERRITE BEAD	30 OHM UPB 1608	
LC210	HLC151K01E	L CHIP COIL	150UH K 120120	
LC211	HFF300B01A	F CHIP FERRITE BEAD	30 OHM UPB 1608	
LC212	HLC151K01E	L CHIP COIL	150UH K 120120	
LC213	HFF300B01A	F CHIP FERRITE BEAD	30 OHM UPB 1608	
LC223	HFF300B01A	F CHIP FERRITE BEAD	30 OHM UPB 1608	
LC226	HFF300B01A	F CHIP FERRITE BEAD	30 OHM UPB 1608	
LC522	HHFH1M501B	F CHIP FERRITE BEAD	HH-1M3216-501J	
LC523	HHFH1M501B	F CHIP FERRITE BEAD	HH-1M3216-501J	
LC530	HHFH1M501B	F CHIP FERRITE BEAD	HH-1M3216-501J	
LC541	HFF300B01A	F CHIP FERRITE BEAD	30 OHM UPB 1608	
LC542	HFF300B01A	F CHIP FERRITE BEAD	30 OHM UPB 1608	
LC543	HFF300B01A	F CHIP FERRITE BEAD	30 OHM UPB 1608	
LC544	HFF300B01A	F CHIP FERRITE BEAD	30 OHM UPB 1608	
LC546	HFF300B01A	F CHIP FERRITE BEAD	30 OHM UPB 1608	
LC555	HFF300B01A	F CHIP FERRITE BEAD	30 OHM UPB 1608	
LC556	HFF300B01A	F CHIP FERRITE BEAD	30 OHM UPB 1608	
LC560	HHFH1M501B	F CHIP FERRITE BEAD	HH-1M3216-501J	
LC561	HHFH1M501B	F CHIP FERRITE BEAD	HH-1M3216-501J	
LC562	HHFH1M501B	F CHIP FERRITE BEAD	HH-1M3216-501J	
LC563	HHFH1M501B	F CHIP FERRITE BEAD	HH-1M3216-501J	
LC564	HHFH1M501B	F CHIP FERRITE BEAD	HH-1M3216-501J	
LC565	HHFH1M501B	F CHIP FERRITE BEAD	HH-1M3216-501J	
LC566	HHFH1M501B	F CHIP FERRITE BEAD	HH-1M3216-501J	
LC567	HFF300B01A	F CHIP FERRITE BEAD	30 OHM UPB 1608	
LC568	HFF300B01A	F CHIP FERRITE BEAD	30 OHM UPB 1608	
LC569	HFF300B01A	F CHIP FERRITE BEAD	30 OHM UPB 1608	
LC570	HFF300B01A	F CHIP FERRITE BEAD	30 OHM UPB 1608	
LC577	HFF300B01A	F CHIP FERRITE BEAD	30 OHM UPB 1608	
LC578	HFF300B01A	F CHIP FERRITE BEAD	30 OHM UPB 1608	
LC591	HFF300B01A	F CHIP FERRITE BEAD	30 OHM UPB 1608	
LC592	HFF300B01A	F CHIP FERRITE BEAD	30 OHM UPB 1608	

Part List

LOC	PART CODE	PART NAME	DESCRIPTION	REMARK
LC593	HFF300B01A	F CHIP FERRITE BEAD	30 OHM UPB 1608	
LC594	HFF300B01A	F CHIP FERRITE BEAD	30 OHM UPB 1608	
LC595	HFF300B01A	F CHIP FERRITE BEAD	30 OHM UPB 1608	
LC711	HFFH1M501B	F CHIP FERRITE BEAD	HH-1M3216-501J	
LC754	HFF300B01A	F CHIP FERRITE BEAD	30 OHM UPB 1608	
LC931	HFF300B01A	F CHIP FERRITE BEAD	30 OHM UPB 1608	
LCA5	HFEACM201A	F CHIP EMI	90 OHM ACM 2012	
LCA6	HFEACM201A	F CHIP EMI	90 OHM ACM 2012	
LCA7	HFEACM201A	F CHIP EMI	90 OHM ACM 2012	
LCA8	HFEACM201A	F CHIP EMI	90 OHM ACM 2012	
PS20	4859293820	CONN WAFER	GT121-31P-TD-A 31P ST	
PA911	4859295120	CONN WAFER	12505WS-05A00	
PA912	4859295220	CONN WAFER	12505WS-06A00	
QC101	T2SC2412KB	TR CHIP	2SC2412K-T146-BR	
QC254	T2SC2412KB	TR CHIP	2SC2412K-T146-BR	
QC302	TUPA672T-B	TR CHIP	UPA672T	
QC402	TBSS138-A	TR CHIP	BSS138	
QC403	TBSS138-A	TR CHIP	BSS138	
QC451	T2SC2412KB	TR CHIP	2SC2412K-T146-BR	
QC503	T2SC2412KB	TR CHIP	2SC2412K-T146-BR	
QC602	T2SC2412KB	TR CHIP	2SC2412K-T146-BR	
QC605	T2SC2412KB	TR CHIP	2SC2412K-T146-BR	
QC755	TUPA672T-B	TR CHIP	UPA672T	
QC901	T2SC2412KB	TR CHIP	2SC2412K-T146-BR	
QC902	T2SC2412KB	TR CHIP	2SC2412K-T146-BR	
RA401	HRTS8E470J	R CHIP ARRAY	1/16 8P 47 OHM J 3216	
RA402	HRTS8E470J	R CHIP ARRAY	1/16 8P 47 OHM J 3216	
RA403	HRTS8E470J	R CHIP ARRAY	1/16 8P 47 OHM J 3216	
RA404	HRTS8E470J	R CHIP ARRAY	1/16 8P 47 OHM J 3216	
RA405	HRTS8E470J	R CHIP ARRAY	1/16 8P 47 OHM J 3216	
RA406	HRTS8E470J	R CHIP ARRAY	1/16 8P 47 OHM J 3216	
RA407	HRTS8E470J	R CHIP ARRAY	1/16 8P 47 OHM J 3216	
RA408	HRTS8E470J	R CHIP ARRAY	1/16 8P 47 OHM J 3216	
RA417	HRTS8E470J	R CHIP ARRAY	1/16 8P 47 OHM J 3216	
RA418	HRTS8E470J	R CHIP ARRAY	1/16 8P 47 OHM J 3216	
RA419	HRTS8E470J	R CHIP ARRAY	1/16 8P 47 OHM J 3216	
RA420	HRTS8E470J	R CHIP ARRAY	1/16 8P 47 OHM J 3216	
RA701	HRTS8E100J	R CHIP ARRAY	1/16 8P 10 OHM 3216	
RA702	HRTS8E100J	R CHIP ARRAY	1/16 8P 10 OHM 3216	
RA703	HRTS8E100J	R CHIP ARRAY	1/16 8P 10 OHM 3216	
RA704	HRTS8E100J	R CHIP ARRAY	1/16 8P 10 OHM 3216	
RA705	HRTS8E100J	R CHIP ARRAY	1/16 8P 10 OHM 3216	
RA706	HRTS8E100J	R CHIP ARRAY	1/16 8P 10 OHM 3216	
RA707	HRTS8E100J	R CHIP ARRAY	1/16 8P 10 OHM 3216	
RA708	HRTS8E100J	R CHIP ARRAY	1/16 8P 10 OHM 3216	
RA709	HRTS8E100J	R CHIP ARRAY	1/16 8P 10 OHM 3216	
RA710	HRTS8E100J	R CHIP ARRAY	1/16 8P 10 OHM 3216	
RA711	HRTS8E100J	R CHIP ARRAY	1/16 8P 10 OHM 3216	
RA712	HRTS8E100J	R CHIP ARRAY	1/16 8P 10 OHM 3216	
RA713	HRTS8E100J	R CHIP ARRAY	1/16 8P 10 OHM 3216	
RA730	HRTS8E470J	R CHIP ARRAY	1/16 8P 47 OHM J 3216	
RA731	HRTS8E470J	R CHIP ARRAY	1/16 8P 47 OHM J 3216	
RA732	HRTS8E470J	R CHIP ARRAY	1/16 8P 47 OHM J 3216	
RC101	HRFT102JBA	R CHIP	1/10 1K OHM J 1608	
RC102	HRFT102JBA	R CHIP	1/10 1K OHM J 1608	
RC103	HRFT123JBA	R CHIP	1/10 12K OHM J 1608	
RC104	HRFT123JBA	R CHIP	1/10 12K OHM J 1608	
RC105	HRFT101JBA	R CHIP	1/10 100 OHM J 1608	
RC119	HRFT101JBA	R CHIP	1/10 100 OHM J 1608	
RC121	HRFT101JBA	R CHIP	1/10 100 OHM J 1608	
RC122	HRFT000-BA	R CHIP	1/10 0 OHM 1608	
RC201	HRFT101JBA	R CHIP	1/10 100 OHM J 1608	
RC202	HRFT224JBA	R CHIP	1/10 220K OHM J 1608	
RC203	HRFT101JBA	R CHIP	1/10 100 OHM J 1608	
RC204	HRFT224JBA	R CHIP	1/10 220K OHM J 1608	
RC205	HRFT750JBA	R CHIP	1/10 75 OHM J 1608	
RC208	HRFT750JBA	R CHIP	1/10 75 OHM J 1608	
RC212	HRFT243JBA	R CHIP	1/10 24K OHM J 1608	

LOC	PART CODE	PART NAME	DESCRIPTION	REMARK
RC213	HRFT123JBA	R CHIP	1/10 12K OHM J 1608	
RC216	HRFT750JBA	R CHIP	1/10 75 OHM J 1608	
RC224	HRFT750JBA	R CHIP	1/10 75 OHM J 1608	
RC225	HRFT101JBA	R CHIP	1/10 100 OHM J 1608	
RC226	HRFT224JBA	R CHIP	1/10 220K OHM J 1608	
RC227	HRFT101JBA	R CHIP	1/10 100 OHM J 1608	
RC228	HRFT101JBA	R CHIP	1/10 100 OHM J 1608	
RC229	HRFT101JBA	R CHIP	1/10 100 OHM J 1608	
RC230	HRFT224JBA	R CHIP	1/10 220K OHM J 1608	
RC231	HRFT750JBA	R CHIP	1/10 75 OHM J 1608	
RC239	HRFT101JBA	R CHIP	1/10 100 OHM J 1608	
RC240	HRFT224JBA	R CHIP	1/10 220K OHM J 1608	
RC241	HRFT101JBA	R CHIP	1/10 100 OHM J 1608	
RC242	HRFT224JBA	R CHIP	1/10 220K OHM J 1608	
RC267	HRFT103JBA	R CHIP	1/10 10K OHM J 1608	
RC268	HRFT103JBA	R CHIP	1/10 10K OHM J 1608	
RC269	HRFT562JBA	R CHIP	1/10 5.6K OHM J 1608	
RC275	HRFT223JBA	R CHIP	1/10 22K OHM J 1608	
RC276	HRFT223JBA	R CHIP	1/10 22K OHM J 1608	
RC279	HRFT750JBA	R CHIP	1/10 75 OHM J 1608	
RC285	HRFT473JBA	R CHIP	1/10 47K OHM J 1608	
RC286	HRFT473JBA	R CHIP	1/10 47K OHM J 1608	
RC287	HRFT473JBA	R CHIP	1/10 47K OHM J 1608	
RC289	HRFT333JBA	R CHIP	1/10 33K OHM J 1608	
RC294	HRFT000JBA	R CHIP	1/10 0 OHM J 1608	
RC296	HRFT750JBA	R CHIP	1/10 75 OHM J 1608	
RC297	HRFT750JBA	R CHIP	1/10 75 OHM J 1608	
RC298	HRFT470JBA	R CHIP	1/10 47 OHM J 1608	
RC331	HRFT472JBA	R CHIP	1/10 4.7K OHM J 1608	
RC332	HRFT472JBA	R CHIP	1/10 4.7K OHM J 1608	
RC333	HRFT101JBA	R CHIP	1/10 100 OHM J 1608	
RC334	HRFT101JBA	R CHIP	1/10 100 OHM J 1608	
RC335	HRFT101JBA	R CHIP	1/10 100 OHM J 1608	
RC336	HRFT101JBA	R CHIP	1/10 100 OHM J 1608	
RC338	HRFT472JBA	R CHIP	1/10 4.7K OHM J 1608	
RC339	HRFT101JBA	R CHIP	1/10 100 OHM J 1608	
RC340	HRFT101JBA	R CHIP	1/10 100 OHM J 1608	
RC362	HRFT272JBA	R CHIP	1/10 2.7K OHM J 1608	
RC363	HRFT332JBA	R CHIP	1/10 3.3K OHM J 1608	
RC364	HRFT332JBA	R CHIP	1/10 3.3K OHM J 1608	
RC365	HRFT101JBA	R CHIP	1/10 100 OHM J 1608	
RC366	HRFT101JBA	R CHIP	1/10 100 OHM J 1608	
RC398	HRFT332JBA	R CHIP	1/10 3.3K OHM J 1608	
RC399	HRFT332JBA	R CHIP	1/10 3.3K OHM J 1608	
RC402	HRFT000JBA	R CHIP	1/10 0 OHM J 1608	
RC403	HRFT000-BA	R CHIP	1/10 0 OHM 1608	
RC404	HRFT000-BA	R CHIP	1/10 0 OHM 1608	
RC406	HRFT302JBA	R CHIP	1/10 3K OHM J 1608	
RC407	HRFT100JBA	R CHIP	1/10 10 OHM J 1608	
RC408	HRFT100JBA	R CHIP	1/10 10 OHM J 1608	
RC409	HRFT100JBA	R CHIP	1/10 10 OHM J 1608	
RC410	HRFT510JBA	R CHIP	1/10 51 OHM J 1608	
RC411	HRFT510JBA	R CHIP	1/10 51 OHM J 1608	
RC413	HRFT101JBA	R CHIP	1/10 100 OHM J 1608	
RC414	HRFT510JBA	R CHIP	1/10 51 OHM J 1608	
RC415	HRFT181JBA	R CHIP	1/10 180 OHM J 1608	
RC420	HRFT181JBA	R CHIP	1/10 180 OHM J 1608	
RC421	HRFT201JBA	R CHIP	1/10 200 OHM J 1608	
RC423	HRFT102FBA	R CHIP	1/10 1K OHM F 1608	
RC424	HRFT102FBA	R CHIP	1/10 1K OHM F 1608	
RC425	HRFT101JBA	R CHIP	1/10 100 OHM J 1608	
RC426	HRFT101JBA	R CHIP	1/10 100 OHM J 1608	
RC429	HRFT101JBA	R CHIP	1/10 100 OHM J 1608	
RC430	HRFT101JBA	R CHIP	1/10 100 OHM J 1608	
RC431	HRFT101JBA	R CHIP	1/10 100 OHM J 1608	
RC433	HRFT000JBA	R CHIP	1/10 0 OHM J 1608	
RC444	HRFT470JBA	R CHIP	1/10 47 OHM J 1608	
RC445	HRFT470JBA	R CHIP	1/10 47 OHM J 1608	

Part List

LOC	PART CODE	PART NAME	DESCRIPTION	REMARK
RC446	HRFT470JBA	R CHIP	1/10 47 OHM J 1608	
RC447	HRFT470JBA	R CHIP	1/10 47 OHM J 1608	
RC448	HRFT100JBA	R CHIP	1/10 10 OHM J 1608	
RC449	HRFT100JBA	R CHIP	1/10 10 OHM J 1608	
RC450	HRFT100JBA	R CHIP	1/10 10 OHM J 1608	
RC451	HRFT100JBA	R CHIP	1/10 10 OHM J 1608	
RC452	HRFT100JBA	R CHIP	1/10 10 OHM J 1608	
RC453	HRFT100JBA	R CHIP	1/10 10 OHM J 1608	
RC454	HRFT100JBA	R CHIP	1/10 10 OHM J 1608	
RC455	HRFT000-BA	R CHIP	1/10 0 OHM 1608	
RC456	HRFT000-BA	R CHIP	1/10 0 OHM 1608	
RC457	HRFT000-BA	R CHIP	1/10 0 OHM 1608	
RC458	HRFT000-BA	R CHIP	1/10 0 OHM 1608	
RC459	HRFT000-BA	R CHIP	1/10 0 OHM 1608	
RC460	HRFT000-BA	R CHIP	1/10 0 OHM 1608	
RC462	HRFT000-BA	R CHIP	1/10 0 OHM 1608	
RC463	HRFT105JBA	R CHIP	1/10 1M OHM J 1608	
RC464	HRFT330JBA	R CHIP	1/10 33 OHM J 1608	
RC465	HRFT100JBA	R CHIP	1/10 10 OHM J 1608	
RC466	HRFT100JBA	R CHIP	1/10 10 OHM J 1608	
RC467	HRFT100JBA	R CHIP	1/10 10 OHM J 1608	
RC468	HRFT100JBA	R CHIP	1/10 10 OHM J 1608	
RC469	HRFT100JBA	R CHIP	1/10 10 OHM J 1608	
RC470	HRFT100JBA	R CHIP	1/10 10 OHM J 1608	
RC471	HRFT100JBA	R CHIP	1/10 10 OHM J 1608	
RC472	HRFT100JBA	R CHIP	1/10 10 OHM J 1608	
RC473	HRFT101JBA	R CHIP	1/10 100 OHM J 1608	
RC474	HRFT101JBA	R CHIP	1/10 100 OHM J 1608	
RC475	HRFT000-BA	R CHIP	1/10 0 OHM 1608	
RC476	HRFT101JBA	R CHIP	1/10 100 OHM J 1608	
RC477	HRFT330JBA	R CHIP	1/10 33 OHM J 1608	
RC478	HRFT330JBA	R CHIP	1/10 33 OHM J 1608	
RC479	HRFT330JBA	R CHIP	1/10 33 OHM J 1608	
RC480	HRFT101JBA	R CHIP	1/10 100 OHM J 1608	
RC481	HRFT101JBA	R CHIP	1/10 100 OHM J 1608	
RC482	HRFT472JBA	R CHIP	1/10 4.7K OHM J 1608	
RC484	HRFT472JBA	R CHIP	1/10 4.7K OHM J 1608	
RC487	HRFT472JBA	R CHIP	1/10 4.7K OHM J 1608	
RC491	HRFT000-BA	R CHIP	1/10 0 OHM 1608	
RC492	HRFT102JBA	R CHIP	1/10 1K OHM J 1608	
RC493	HRFT203JBA	R CHIP	1/10 20K OHM J 1608	
RC494	HRFT000-BA	R CHIP	1/10 0 OHM 1608	
RC495	HRFT000-BA	R CHIP	1/10 0 OHM 1608	
RC496	HRFT474JBA	R CHIP	1/10 470K OHM J 1608	
RC497	HRFT474JBA	R CHIP	1/10 470K OHM J 1608	
RC498	HRFT201JBA	R CHIP	1/10 200 OHM J 1608	
RC499	HRFT201JBA	R CHIP	1/10 200 OHM J 1608	
RC501	HRFT100JBA	R CHIP	1/10 10 OHM J 1608	
RC502	HRFT100JBA	R CHIP	1/10 10 OHM J 1608	
RC503	HRFT100JBA	R CHIP	1/10 10 OHM J 1608	
RC504	HRFT100JBA	R CHIP	1/10 10 OHM J 1608	
RC505	HRFT100JBA	R CHIP	1/10 10 OHM J 1608	
RC506	HRFT100JBA	R CHIP	1/10 10 OHM J 1608	
RC507	HRFT100JBA	R CHIP	1/10 10 OHM J 1608	
RC508	HRFT100JBA	R CHIP	1/10 10 OHM J 1608	
RC509	HRFT100JBA	R CHIP	1/10 10 OHM J 1608	
RC510	HRFT100JBA	R CHIP	1/10 10 OHM J 1608	
RC511	HRFT000-BA	R CHIP	1/10 0 OHM 1608	
RC514	HRFT332JBA	R CHIP	1/10 3.3K OHM J 1608	
RC519	HRFT272JBA	R CHIP	1/10 2.7K OHM J 1608	
RC520	HRFT332JBA	R CHIP	1/10 3.3K OHM J 1608	
RC521	HRFT332JBA	R CHIP	1/10 3.3K OHM J 1608	
RC548	HRFT000-BA	R CHIP	1/10 0 OHM 1608	
RC549	HRFT000-BA	R CHIP	1/10 0 OHM 1608	
RC550	HRFT000-BA	R CHIP	1/10 0 OHM 1608	
RC551	HRFT000-BA	R CHIP	1/10 0 OHM 1608	
RC552	HRFT000-BA	R CHIP	1/10 0 OHM 1608	
RC553	HRFT000-BA	R CHIP	1/10 0 OHM 1608	

LOC	PART CODE	PART NAME	DESCRIPTION	REMARK
RC554	HRFT000-BA	R CHIP	1/10 0 OHM 1608	
RC555	HRFT000-BA	R CHIP	1/10 0 OHM 1608	
RC558	HRFT000-BA	R CHIP	1/10 0 OHM 1608	
RC559	HRFT000-BA	R CHIP	1/10 0 OHM 1608	
RC573	HRFT472JBA	R CHIP	1/10 4.7K OHM J 1608	
RC574	HRFT000-BA	R CHIP	1/10 0 OHM 1608	
RC575	HRFT512JBA	R CHIP	1/10 5.1K OHM J 1608	
RC576	HRFT470JBA	R CHIP	1/10 47 OHM J 1608	
RC577	HRFT470JBA	R CHIP	1/10 47 OHM J 1608	
RC578	HRFT470JBA	R CHIP	1/10 47 OHM J 1608	
RC579	HRFT512JBA	R CHIP	1/10 5.1K OHM J 1608	
RC580	HRFT000-BA	R CHIP	1/10 0 OHM 1608	
RC581	HRFT103JBA	R CHIP	1/10 10K OHM J 1608	
RC582	HRFT103JBA	R CHIP	1/10 10K OHM J 1608	
RC584	HRFT105JBA	R CHIP	1/10 1M OHM J 1608	
RC588	HRFT470JBA	R CHIP	1/10 47 OHM J 1608	
RC589	HRFT470JBA	R CHIP	1/10 47 OHM J 1608	
RC590	HRFT470JBA	R CHIP	1/10 47 OHM J 1608	
RC591	HRFT470JBA	R CHIP	1/10 47 OHM J 1608	
RC592	HRFT000-BA	R CHIP	1/10 0 OHM 1608	
RC598	HRFT470JBA	R CHIP	1/10 47 OHM J 1608	
RC599	HRFT470JBA	R CHIP	1/10 47 OHM J 1608	
RC601	HRFT101JBA	R CHIP	1/10 100 OHM J 1608	
RC602	HRFT101JBA	R CHIP	1/10 100 OHM J 1608	
RC603	HRFT472JBA	R CHIP	1/10 4.7K OHM J 1608	
RC604	HRFT102JBA	R CHIP	1/10 1K OHM J 1608	
RC605	HRFT222JBA	R CHIP	1/10 2.2K OHM J 1608	
RC607	HRFT272JBA	R CHIP	1/10 2.7K OHM J 1608	
RC611	HRFT392JBA	R CHIP	1/10 3.9K OHM J 1608	
RC612	HRFT392JBA	R CHIP	1/10 3.9K OHM J 1608	
RC613	HRFT103FBA	R CHIP	1/10 10K OHM F 1608	
RC614	HRFT103FBA	R CHIP	1/10 10K OHM F 1608	
RC620	HRFT519JBA	R CHIP	1/10 5.1 OHM J 1608	
RC621	HRFT332JBA	R CHIP	1/10 3.3K OHM J 1608	
RC622	HRFT101JBA	R CHIP	1/10 100 OHM J 1608	
RC623	HRFT101JBA	R CHIP	1/10 100 OHM J 1608	
RC628	HRFT202JBA	R CHIP	1/10 2K OHM J 1608	
RC632	HRFT220JBA	R CHIP	1/10 22 OHM J 1608	
RC634	HRFT103FBA	R CHIP	1/10 10K OHM F 1608	
RC635	HRFT103FBA	R CHIP	1/10 10K OHM F 1608	
RC636	HRFT220JBA	R CHIP	1/10 22 OHM J 1608	
RC637	HRFT519JBA	R CHIP	1/10 5.1 OHM J 1608	
RC655	HRFT000-BA	R CHIP	1/10 0 OHM 1608	
RC666	HRFT101JBA	R CHIP	1/10 100 OHM J 1608	
RC667	HRFT101JBA	R CHIP	1/10 100 OHM J 1608	
RC668	HRFT472JBA	R CHIP	1/10 4.7K OHM J 1608	
RC675	HRFT102JBA	R CHIP	1/10 1K OHM J 1608	
RC679	HRFT000-BA	R CHIP	1/10 0 OHM 1608	
RC680	HRFT101JBA	R CHIP	1/10 100 OHM J 1608	
RC697	HRFT000-BA	R CHIP	1/10 0 OHM 1608	
RC698	HRFT000-BA	R CHIP	1/10 0 OHM 1608	
RC700	HRFT000-BA	R CHIP	1/10 0 OHM 1608	
RC701	HRFT472JBA	R CHIP	1/10 4.7K OHM J 1608	
RC702	HRFT101JBA	R CHIP	1/10 100 OHM J 1608	
RC703	HRFT101JBA	R CHIP	1/10 100 OHM J 1608	
RC704	HRFT101JBA	R CHIP	1/10 100 OHM J 1608	
RC705	HRFT101JBA	R CHIP	1/10 100 OHM J 1608	
RC706	HRFT101JBA	R CHIP	1/10 100 OHM J 1608	
RC707	HRFT101JBA	R CHIP	1/10 100 OHM J 1608	
RC709	HRFT331JBA	R CHIP	1/10 330 OHM J 1608	
RC710	HRFT472JBA	R CHIP	1/10 4.7K OHM J 1608	
RC711	HRFT472JBA	R CHIP	1/10 4.7K OHM J 1608	
RC712	HRFT472JBA	R CHIP	1/10 4.7K OHM J 1608	
RC713	HRFT101JBA	R CHIP	1/10 100 OHM J 1608	
RC714	HRFT101JBA	R CHIP	1/10 100 OHM J 1608	
RC715	HRFT101JBA	R CHIP	1/10 100 OHM J 1608	
RC716	HRFT101JBA	R CHIP	1/10 100 OHM J 1608	
RC717	HRFT472JBA	R CHIP	1/10 4.7K OHM J 1608	

Part List

LOC	PART CODE	PART NAME	DESCRIPTION	REMARK
RC718	HRFT101JBA	R CHIP	1/10 100 OHM J 1608	
RC719	HRFT101JBA	R CHIP	1/10 100 OHM J 1608	
RC720	HRFT472JBA	R CHIP	1/10 4.7K OHM J 1608	
RC721	HRFT101JBA	R CHIP	1/10 100 OHM J 1608	
RC722	HRFT101JBA	R CHIP	1/10 100 OHM J 1608	
RC723	HRFT101JBA	R CHIP	1/10 100 OHM J 1608	
RC724	HRFT101JBA	R CHIP	1/10 100 OHM J 1608	
RC725	HRFT101JBA	R CHIP	1/10 100 OHM J 1608	
RC726	HRFT101JBA	R CHIP	1/10 100 OHM J 1608	
RC727	HRFT101JBA	R CHIP	1/10 100 OHM J 1608	
RC728	HRFT101JBA	R CHIP	1/10 100 OHM J 1608	
RC729	HRFT472JBA	R CHIP	1/10 4.7K OHM J 1608	
RC730	HRFT472JBA	R CHIP	1/10 4.7K OHM J 1608	
RC731	HRFT000JBA	R CHIP	1/10 0 OHM J 1608	
RC732	HRFT101JBA	R CHIP	1/10 100 OHM J 1608	
RC733	HRFT101JBA	R CHIP	1/10 100 OHM J 1608	
RC734	HRFT101JBA	R CHIP	1/10 100 OHM J 1608	
RC735	HRFT512JBA	R CHIP	1/10 5.1K OHM J 1608	
RC736	HRFT000-BA	R CHIP	1/10 0 OHM 1608	
RC737	HRFT000-BA	R CHIP	1/10 0 OHM 1608	
RC738	HRFT000-BA	R CHIP	1/10 0 OHM 1608	
RC739	HRFT000-BA	R CHIP	1/10 0 OHM 1608	
RC740	HRFT000-BA	R CHIP	1/10 0 OHM 1608	
RC741	HRFT000-BA	R CHIP	1/10 0 OHM 1608	
RC743	HRFT472JBA	R CHIP	1/10 4.7K OHM J 1608	
RC744	HRFT472JBA	R CHIP	1/10 4.7K OHM J 1608	
RC745	HRFT472JBA	R CHIP	1/10 4.7K OHM J 1608	
RC746	HRFT512JBA	R CHIP	1/10 5.1K OHM J 1608	
RC747	HRFT512JBA	R CHIP	1/10 5.1K OHM J 1608	
RC748	HRFT512JBA	R CHIP	1/10 5.1K OHM J 1608	
RC749	HRFT512JBA	R CHIP	1/10 5.1K OHM J 1608	
RC750	HRFT000-BA	R CHIP	1/10 0 OHM 1608	
RC751	HRFT000-BA	R CHIP	1/10 0 OHM 1608	
RC752	HRFT101JBA	R CHIP	1/10 100 OHM J 1608	
RC753	HRFT101JBA	R CHIP	1/10 100 OHM J 1608	
RC754	HRFT472JBA	R CHIP	1/10 4.7K OHM J 1608	
RC755	HRFT472JBA	R CHIP	1/10 4.7K OHM J 1608	
RC756	HRFT472JBA	R CHIP	1/10 4.7K OHM J 1608	
RC757	HRFT202JBA	R CHIP	1/10 2K OHM J 1608	
RC758	HRFT220JBA	R CHIP	1/10 22 OHM J 1608	
RC759	HRFT220JBA	R CHIP	1/10 22 OHM J 1608	
RC760	HRFT330JBA	R CHIP	1/10 33 OHM J 1608	
RC761	HRFT000-BA	R CHIP	1/10 0 OHM 1608	
RC762	HRFT000-BA	R CHIP	1/10 0 OHM 1608	
RC764	HRFT100JBA	R CHIP	1/10 10 OHM J 1608	
RC765	HRFT220JBA	R CHIP	1/10 22 OHM J 1608	
RC766	HRFT220JBA	R CHIP	1/10 22 OHM J 1608	
RC767	HRFT000-BA	R CHIP	1/10 0 OHM 1608	
RC768	HRFT000-BA	R CHIP	1/10 0 OHM 1608	
RC769	HRFT000-BA	R CHIP	1/10 0 OHM 1608	
RC770	HRFT000-BA	R CHIP	1/10 0 OHM 1608	
RC771	HRFT472JBA	R CHIP	1/10 4.7K OHM J 1608	
RC772	HRFT101JBA	R CHIP	1/10 100 OHM J 1608	
RC773	HRFT101JBA	R CHIP	1/10 100 OHM J 1608	
RC774	HRFT330JBA	R CHIP	1/10 33 OHM J 1608	
RC775	HRFT000-BA	R CHIP	1/10 0 OHM 1608	
RC776	HRFT472JBA	R CHIP	1/10 4.7K OHM J 1608	
RC777	HRFT220JBA	R CHIP	1/10 22 OHM J 1608	
RC778	HRFT472JBA	R CHIP	1/10 4.7K OHM J 1608	
RC779	HRFT472JBA	R CHIP	1/10 4.7K OHM J 1608	
RC780	HRFT472JBA	R CHIP	1/10 4.7K OHM J 1608	
RC781	HRFT000-BA	R CHIP	1/10 0 OHM 1608	
RC782	HRFT472JBA	R CHIP	1/10 4.7K OHM J 1608	
RC783	HRFT472JBA	R CHIP	1/10 4.7K OHM J 1608	
RC784	HRFT472JBA	R CHIP	1/10 4.7K OHM J 1608	
RC786	HRFT000-BA	R CHIP	1/10 0 OHM 1608	
RC787	HRFT472JBA	R CHIP	1/10 4.7K OHM J 1608	
RC788	HRFT472JBA	R CHIP	1/10 4.7K OHM J 1608	

LOC	PART CODE	PART NAME	DESCRIPTION	REMARK
RC789	HRFT000JBA	R CHIP	1/10 0 OHM J 1608	
RC790	HRFT152JBA	R CHIP	1/10 1.5K OHM J 1608	
RC791	HRFT512JBA	R CHIP	1/10 5.1K OHM J 1608	
RC792	HRFT101JBA	R CHIP	1/10 100 OHM J 1608	
RC793	HRFT472JBA	R CHIP	1/10 4.7K OHM J 1608	
RC795	HRFT000-BA	R CHIP	1/10 0 OHM 1608	
RC796	HRFT472JBA	R CHIP	1/10 4.7K OHM J 1608	
RC797	HRFT000-BA	R CHIP	1/10 0 OHM 1608	
RC798	HRFT103JBA	R CHIP	1/10 10K OHM J 1608	
RC931	HRFT511JBA	R CHIP	1/10 510 OHM J 1608	
RC932	HRFT511JBA	R CHIP	1/10 510 OHM J 1608	
RC933	HRFT332JBA	R CHIP	1/10 3.3K OHM J 1608	
RC934	HRFT102JBA	R CHIP	1/10 1K OHM J 1608	
RC935	HRFT332JBA	R CHIP	1/10 3.3K OHM J 1608	
ZA201	HFEACF470B	F CHIP EMI	ACF321825 47P	
ZA203	HFEACF470B	F CHIP EMI	ACF321825 47P	
ZA204	HFEACF470B	F CHIP EMI	ACF321825 47P	
ZA205	HFEACF470B	F CHIP EMI	ACF321825 47P	
ZA206	HFEACF470B	F CHIP EMI	ACF321825 47P	
ZA207	HFEACF470B	F CHIP EMI	ACF321825 47P	
ZA208	HFEACF470B	F CHIP EMI	ACF321825 47P	
ZA224	HFEACF470B	F CHIP EMI	ACF321825 47P	
ZA225	HFEACF470B	F CHIP EMI	ACF321825 47P	
ZA226	HFEACF470B	F CHIP EMI	ACF321825 47P	
ZA227	HFEACF470B	F CHIP EMI	ACF321825 47P	
ZA501	HFEACF470B	F CHIP EMI	ACF321825 47P	
ZA601	HFEACF470B	F CHIP EMI	ACF321825 47P	
ZA602	HFEACF470B	F CHIP EMI	ACF321825 47P	
ZZ310	PTPWMSG116	PCB POWER MANUAL AS	DLP-32C2AMS	
100	2193110012	SOLDER WIRE	SAC3000 ϕ 3.0MM (LFA3C0-W3.0)	
200	2193110024	SOLDER WIRE	SAC3005 ϕ 1.6MM (LFA3-107-W1.6)	
300	2291050623	FLUX SOLDER LF	SV-PBF-304P(0.823)	
400	2291050312	FLUX SOLVENT	S-3000	
C801	CL1UC3474M	C LINE ACROSS	0.47MF 1J(UVCVSNDF/SV)+Q/O	
C802	CL1UC3224M	C LINE ACROSS	0.22MF 1J(UVCVSNDF/SV)+Q/O	
C804	CH1BFB471K	C CERA AC	AC400V 470PF K SD	
C805	CH1BFB471K	C CERA AC	AC400V 470PF K SD	
C810	CL1UC3105M	C LINE ACROSS	AC275V 1MF PCX2 337M	
C811	CEYP2W181D	C ELECTRO	450V FUX 180MF (35X30)	
C825	CMYF2J104J	C MYLAR	630V MPP 0.1MF J	
C890	CH1BFE472M	C CERA AC	AC400V 4700PF M U/C/V	
C891	CH1BFE472M	C CERA AC	AC400V 4700PF M U/C/V	
C899	CH1BFB471K	C CERA AC	AC400V 470PF K SD	
CS812	CCXR3D221K	C CERA	2KV R 220PF K 125C	
D801	PTA3SW2900	HEAT SINK ASS'Y	DGBJ606--- + 7218301212	
00001	DGBJ606---	DIODE BRIDGE	GBJ606	
0000A	4857032900	HEAT SINK	AL EX	
0000B	7174300851	SCREW TAPPTITE	TT2 RND 3X8 MFZN 3CR	
D803	DSF8L60USM	DIODE	SF8L60USM	
D815	PTC2SW4508	HEAT SINK ASS'Y	DFME210B-- + 7128301252	
00001	DFME210B--	DIODE	FME-210B	
0000A	4857024508	HEAT SINK	AL EX BK	
0000B	7174300851	SCREW TAPPTITE	TT2 RND 3X8 MFZN 3CR	
D816	DFML12S---	DIODE	FML-12S	
D840	PTB2SW4508	HEAT SINK ASS'Y	DFMX22SL-- + 7128301252	
00001	DFMX22SL--	DIODE	FMX-22SL	
0000A	4857024508	HEAT SINK	AL EX BK	
0000B	7174300851	SCREW TAPPTITE	TT2 RND 3X8 MFZN 3CR	
D841	PTB2SW4508	HEAT SINK ASS'Y	DFMX22SL-- + 7128301252	
00001	DFMX22SL--	DIODE	FMX-22SL	
0000A	4857024508	HEAT SINK	AL EX BK	
0000B	7174300851	SCREW TAPPTITE	TT2 RND 3X8 MFZN 3CR	
D842	PTB2SW4508	HEAT SINK ASS'Y	DFMX22SL-- + 7128301252	
00001	DFMX22SL--	DIODE	FMX-22SL	
0000A	4857024508	HEAT SINK	AL EX BK	
0000B	7174300851	SCREW TAPPTITE	TT2 RND 3X8 MFZN 3CR	
DS801	DD2SB80---	DIODE BRIDGE	D2SB80	
F801	5FKGB5022R	FUSE GLASS TUBE	KS MF51 5A 250V NR	

Part List

LOC	PART CODE	PART NAME	DESCRIPTION	REMARK
I801	1FA5501AP-	IC	FA5501AP	
I802	PTA3SW3100	HEAT SINK ASS'Y	1STRT2268- + 7128301252	
00001	1STRT2268-	IC POWER	STR-T2268	
0000A	4857033100	HEAT SINK	AL EX BK	
0000B	7174300851	SCREW TAPPTITE	TT2 RND 3X8 MFZN 3CR	
I803	1LTV817C--	IC PHOTO COUPLER	LTV-817C	
I804	1LTV817C--	IC PHOTO COUPLER	LTV-817C	
I806	PTA2SW4519	HEAT SINK ASS'Y	1LA5752--+ + 7128301252	
00001	1LA5752---	IC SW REG	LA5752	
0000A	4857024519	HEAT SINK	AL EX (NO ANODIZING)	
0000B	7174300851	SCREW TAPPTITE	TT2 RND 3X8 MFZN 3CR	
IS801	1STRA6151-	IC STAND-BY	STR-A6151	
IS802	1K1A431B--	IC REGULATOR(SHUNT)	K1A431B 2.495V 0.5% TO-92	
L801	5PTR19A1--	FILTER LINE	TR19-A1	
L802	5PTR19A1--	FILTER LINE	TR19-A1	
L803	5PTR19A2--	FILTER LINE	TR19-A2	
L842	58C0000131	COIL CHOKE	CH-101A	
M001	2224050077	BOND SILICON	SE-9590 RTV(V0)	
MP804	4850K01700	CORE FERRITE	BNF-1130	
P803	4859298620	CONN WAFER	SMW200-14P	
P804	4850708S20	CONNECTOR	YH025-08+YBNH250-08+ULW=400	
PA801	PTSXSWG084	SOCKET ASS'Y	DL2-3210SMS	
P801	4859301020	SOCKET AC	0714-CP7N	
Q801	PTE2SW4508	HEAT SINK ASS'Y	TW20NM60--+ + 7174301251	
00001	TW20NM60--	FET	STW20NM60	
0000A	4857024508	HEAT SINK	AL EX BK	
0000B	4857619500	INSU PLATE	SILICON RUBBER T0.3	
0000C	7174301251	SCREW TAPPTITE	TT2 RND 3X12 MFZN 3CR	
R836	RM02Y228J-	R METAL FLAT	2W 0.22 OHM J	
T802	58C0000156	COIL CHOKE PFC	CPC-321A	
T803	50M2577A1-	TRANS SMPS	TSM-2577A1	
TH800	D5CK15056-	THERMISTOR	SCK15056MS	
TS801	50MST25A1-	TRANS SMPS	ST-25A1	
YS801	5SC0101339	SW RELAY	SDT-S-105LMR	
Z801	DSVC471D14	VARISTOR	SVC471D14A (BULK)	
Z2200	PTPWJ2G116	PCB POWER CHIP B AS	DLP-32C2AMSB	
CC813	HCBK222KBA	C CHIP CERA	50V X7R 2200PF K 1608	
CC817	HCBK222KBA	C CHIP CERA	50V X7R 2200PF K 1608	
CC835	HCBK102KBA	C CHIP CERA	50V X7R 1000PF K 1608	
CC837	HCBK152KBA	C CHIP CERA	50V X7R 1500PF K 1608	
CC856	HCBK103KBA	C CHIP CERA	50V X7R 0.01MF K 1608	
DC814	DM2FM3--C	DIODE CHIP SCHOTTKY	M2FM3 M2F TYPE	
RC807	HRFT202FBA	R CHIP	1/10 2K OHM F 1608	
RC808	HRFT102JBA	R CHIP	1/10 1K OHM J 1608	
RC809	HRFT222FBA	R CHIP	1/10 2.2K OHM F 1608	
RC810	HRFT681JBA	R CHIP	1/10 680 OHM J 1608	
RC814	HRFT681JBA	R CHIP	1/10 680 OHM J 1608	
RC817	HRFT223JBA	R CHIP	1/10 22K OHM J 1608	
RC819	HRFT103FBA	R CHIP	1/10 10K OHM F 1608	
RC826	HRFT223JBA	R CHIP	1/10 22K OHM J 1608	
RC830	HRFT123JBA	R CHIP	1/10 12K OHM J 1608	
RC832	HRFT222JBA	R CHIP	1/10 2.2K OHM J 1608	
RC835	HRFT391JBA	R CHIP	1/10 390 OHM J 1608	
RC840	HRFT113JBA	R CHIP	1/10 11K OHM J 1608	
RC841	HRFT682JBA	R CHIP	1/10 6.8K OHM J 1608	
RC844	HRFT202FBA	R CHIP	1/10 2K OHM F 1608	
RC845	HRFT102JBA	R CHIP	1/10 1K OHM J 1608	
RC846	HRFT222JBA	R CHIP	1/10 2.2K OHM J 1608	
RC847	HRFT472JBA	R CHIP	1/10 4.7K OHM J 1608	
RC850	HRFT472JBA	R CHIP	1/10 4.7K OHM J 1608	
RC851	HRFT102JBA	R CHIP	1/10 1K OHM J 1608	
RC854	HRFT183JBA	R CHIP	1/10 18K OHM J 1608	
RC855	HRFT183JBA	R CHIP	1/10 18K OHM J 1608	
RC856	HRFT472JBA	R CHIP	1/10 4.7K OHM J 1608	
Z2200	PTPWJ0G116	PCBPOWERODD SHAPE (PHU)AS	DLP-32C2AMSB	
C808	CH1BEE222M	C CERA AC	U/C/V 2.5KV 2200PF TP	
C809	CH1BEE222M	C CERA AC	U/C/V 2.5KV 2200PF TP	
C823	CCXR3D221K	C CERA	2KV R 220PF K 125C	

LOC	PART CODE	PART NAME	DESCRIPTION	REMARK
C826	CMXM2A224J	C MYLAR	100V 0.22MF J	
C827	CEXF1H101C	C ELECTRO	50V RUS 100MF (8X11.5) TP	
C833	CMXM2A224J	C MYLAR	100V 0.22MF J	
C840	CCXB3D471K	C CERA	2KV B 470PF K (TAPPING)	
C842	CEXF1V102C	C ELECTRO	35V RUS 1000MF (13X25) TP	
C843	CEXF1V102C	C ELECTRO	35V RUS 1000MF (13X25) TP	
C845	CEXF1C471C	C ELECTRO	16V RUS 470MF (10X12.5)TP	
C848	CEXF1C222C	C ELECTRO	16V RUS 2200MF (13X25) TP	
C849	CCXB3D471K	C CERA	2KV B 470PF K (TAPPING)	
C850	CEXF1H102V	C ELECTRO	50V RSS 1000MF (16X25) TP	
C851	CEXF1H102V	C ELECTRO	50V RSS 1000MF (16X25) TP	
C853	CEXF1C222C	C ELECTRO	16V RUS 2200MF (13X25) TP	
CS801	CEXF2G220V	C ELECTRO	400V RSS 22MF (16X25) TP	
CS804	CH1BEE222M	C CERA AC	U/C/V 2.5KV 2200PF TP	
CS805	CH1BEE222M	C CERA AC	U/C/V 2.5KV 2200PF TP	
CS807	CBXB3D102K	C CERA SEMI	2KV BL(N) 1000PF K (T)	
CS814	CCXB3D221K	C CERA	2KV B 220PF K (TAPPING)	
Z2200	PTPWJBG116	PCB POWER M-10 AS	DLP-32C2AMSB	
500	2TM18006BE	TAPE MASKING	6.2X500	
E1	4856310300	EYE LET	BSR T0.2 (R1.6)	
E10	4856310300	EYE LET	BSR T0.2 (R1.6)	
E11	4856310300	EYE LET	BSR T0.2 (R1.6)	
E12	4856310300	EYE LET	BSR T0.2 (R1.6)	
E13	4856310300	EYE LET	BSR T0.2 (R1.6)	
E14	4856310300	EYE LET	BSR T0.2 (R1.6)	
E15	4856310300	EYE LET	BSR T0.2 (R1.6)	
E16	4856310300	EYE LET	BSR T0.2 (R1.6)	
E17	4856310300	EYE LET	BSR T0.2 (R1.6)	
E19	4856310600	EYE LET	BSR T0.2 (R2.3)	
E2	4856310300	EYE LET	BSR T0.2 (R1.6)	
E20	4856310600	EYE LET	BSR T0.2 (R2.3)	
E21	4856310300	EYE LET	BSR T0.2 (R1.6)	
E22	4856310300	EYE LET	BSR T0.2 (R1.6)	
E23	4856310300	EYE LET	BSR T0.2 (R1.6)	
E24	4856310300	EYE LET	BSR T0.2 (R1.6)	
E25	4856310300	EYE LET	BSR T0.2 (R1.6)	
E26	4856310600	EYE LET	BSR T0.2 (R2.3)	
E27	4856310300	EYE LET	BSR T0.2 (R1.6)	
E28	4856310300	EYE LET	BSR T0.2 (R1.6)	
E29	4856310300	EYE LET	BSR T0.2 (R1.6)	
E30	4856310300	EYE LET	BSR T0.2 (R1.6)	
E31	4856310600	EYE LET	BSR T0.2 (R2.3)	
E32	4856310300	EYE LET	BSR T0.2 (R1.6)	
E4	4856310300	EYE LET	BSR T0.2 (R1.6)	
E40	4856310300	EYE LET	BSR T0.2 (R1.6)	
E41	4856310300	EYE LET	BSR T0.2 (R1.6)	
E42	4856310300	EYE LET	BSR T0.2 (R1.6)	
E43	4856310300	EYE LET	BSR T0.2 (R1.6)	
E44	4856310300	EYE LET	BSR T0.2 (R1.6)	
E45	4856310300	EYE LET	BSR T0.2 (R1.6)	
E46	4856310300	EYE LET	BSR T0.2 (R1.6)	
E47	4856310300	EYE LET	BSR T0.2 (R1.6)	
E48	4856310300	EYE LET	BSR T0.2 (R1.6)	
E49	4856310300	EYE LET	BSR T0.2 (R1.6)	
E5	4856310300	EYE LET	BSR T0.2 (R1.6)	
E50	4856310300	EYE LET	BSR T0.2 (R1.6)	
E51	4856310300	EYE LET	BSR T0.2 (R1.6)	
E6	4856310300	EYE LET	BSR T0.2 (R1.6)	
E7	4856310300	EYE LET	BSR T0.2 (R1.6)	
E8	4856310300	EYE LET	BSR T0.2 (R1.6)	
E9	4856310300	EYE LET	BSR T0.2 (R1.6)	
P802	485923512S	CONN WAFER	YW025-08 (STICK)	
P805	485923172S	CONN WAFER	YW025-04 (STICK)	
R822	RS02Z228J-	R M-OXIDE FILM	2W 0.22 OHM J (TAPPING)	
R833	RS01Z220J-	R M-OXIDE FILM	1W 22 OHM J (TAPPING)	
R840	RS02Z151J-	R M-OXIDE FILM	2W 150 OHM J (TAPPING)	
R849	RS02Z151J-	R M-OXIDE FILM	2W 150 OHM J (TAPPING)	
RS801	RS02Z101JS	R M-OXIDE FILM	2W 100 OHM J SMALL	

Part List

LOC	PART CODE	PART NAME	DESCRIPTION	REMARK
RS803	RS012823J-	R M-OXIDE FILM	1W 82K OHM J (TAPPING)	
ZZ200	PTPWJRG116	PCB POWER RADIAL AS	DLP-32C2AMSB	
C812	CCXR3A101K	C CERA	1KV R 100PF K	
C815	CMXM2A223J	C MYLAR	100V 0.022MF J TP	
C816	CEXF1H109V	C ELECTRO	50V RSS 1MF (5X11) TP	
C817	CMXL1J105J	C MYLAR	63V MEU 1MF J	
C818	CMXM2A102J	C MYLAR	100V 1000PF J (TP)	
C819	CEXF1H220V	C ELECTRO	50V RSS 22MF (5X11) TP	
C820	CXSL2H100D	C CERA	500V SL 10PF D (TAPPING)	
C821	CXSL2H100D	C CERA	500V SL 10PF D (TAPPING)	
C829	CEXF1H229V	C ELECTRO	50V RSS 2.2MF (5X11) TP	
C831	CMXL1J105J	C MYLAR	63V MEU 1MF J	
C836	CEXF1H470C	C ELECTRO	50V RUS 47MF (6.3X11) TP	
C838	CMXM2A683J	C MYLAR	100V 0.068MF J (TP)	
C846	CMXM2A104J	C MYLAR	100V 0.1MF J (TP)	
C855	CMXL1J474J	C MYLAR	63V MEU 0.47MF J	
CS808	CEXF1H220V	C ELECTRO	50V RSS 22MF (5X11) TP	
CS809	CMXM2A104J	C MYLAR	100V 0.1MF J (TP)	
CS810	CEXF1E101V	C ELECTRO	25V RSS 100MF (6.3X11) TP	
CS815	CEXF1C221V	C ELECTRO	16V RSS 220MF (8X11.5) TP	
F801A	4857415001	CLIP FUSE	PF5000-0702	
F801B	4857415001	CLIP FUSE	PF5000-0702	
I805	1K1A431B--	IC REGULATOR(SHUNT)	KIA431B 2.495V 0.5% TO-92	
L841	58C0000096	COIL CHOKE	610G0233(470K)	
Q804	TKTC3203Y-	TR	KTC3203-Y	
Q805	TKTC3203Y-	TR	KTC3203-Y	
ZZ200	PTPWJAG116	PCB POWER AXIAL AS	DLP-32C2AMSB	
510	2TM14006LB	TAPE MASKING	3M #232 6.0X2000M	
520	2TM10006LB	TAPE MASKING	3M #232-MAP-C 6.2X2000M	
A001	4859816111	PCB POWER	246X246 D1L	
D805	DD1NS47060	DIODE	D1NS4-7060	
D806	DZEG01C---	DIODE	EG01C	
D807	DUF4007---	DIODE	UF4007 DO-41 1000V 1A	
D809	DUF4007---	DIODE	UF4007 DO-41 1000V 1A	
D810	DUF4007---	DIODE	UF4007 DO-41 1000V 1A	
D812	DUZ24BM--	DIODE ZENER	UZ-24BM	
D813	DZEG01C---	DIODE	EG01C	
D845	D1N4937G--	DIODE	1N4937G (TAPPING)	
D850	D1N4148---	DIODE	1N4148 (TAPPING)	
DS806	DRU1P----	DIODE	RU1P	
DS807	DRGP15JP--	DIODE	RGP-15JP	
DS808	DUZ6R2BM--	DIODE ZENER	UZ-6.2BM	
DS810	DRGP15JP--	DIODE	RGP-15JP	
J800	85801060GY	WIRE COPPER	1/0.6 TIN COATING	
J801	85801060GY	WIRE COPPER	1/0.6 TIN COATING	
J802	85801060GY	WIRE COPPER	1/0.6 TIN COATING	
J804	85801060GY	WIRE COPPER	1/0.6 TIN COATING	
J805	85801060GY	WIRE COPPER	1/0.6 TIN COATING	
J806	85801060GY	WIRE COPPER	1/0.6 TIN COATING	
J807	85801060GY	WIRE COPPER	1/0.6 TIN COATING	
J809	85801060GY	WIRE COPPER	1/0.6 TIN COATING	
J810	85801060GY	WIRE COPPER	1/0.6 TIN COATING	
J811	85801060GY	WIRE COPPER	1/0.6 TIN COATING	
J812	85801060GY	WIRE COPPER	1/0.6 TIN COATING	
J813	85801060GY	WIRE COPPER	1/0.6 TIN COATING	
J814	85801060GY	WIRE COPPER	1/0.6 TIN COATING	
J815	85801060GY	WIRE COPPER	1/0.6 TIN COATING	
J816	85801060GY	WIRE COPPER	1/0.6 TIN COATING	
J858	85801060GY	WIRE COPPER	1/0.6 TIN COATING	
L804	5MC0000100	COIL BEAD	HC-3550	
L805	5MC0000100	COIL BEAD	HC-3550	
L806	5MC0000100	COIL BEAD	HC-3550	
R804	RD-2Z474J-	R CARBON FILM	1/2 470K OHM J	
R811	RN-4Z4703F	R METAL FILM	1/4 470K OHM F	
R812	RN-4Z4703F	R METAL FILM	1/4 470K OHM F	
R813	RN-4Z3003F	R METAL FILM	1/4 300K OHM F	
R814	RN-4Z8203F	R METAL FILM	1/4 820K OHM F	
R815	RN-4Z8203F	R METAL FILM	1/4 820K OHM F	

LOC	PART CODE	PART NAME	DESCRIPTION	REMARK
R816	RN-4Z8203F	R METAL FILM	1/4 820K OHM F	
R817	RN-4Z7500F	R METAL FILM	1/4 750 OHM F	
R818	RN-4Z1602F	R METAL FILM	1/4 16.0K OHM F	
R824	RD-4Z101J-	R CARBON FILM	1/4 100 OHM J	
R825	RD-4Z100J-	R CARBON FILM	1/4 10 OHM J	
R827	RD-4Z101J-	R CARBON FILM	1/4 100 OHM J	
R828	RD-4Z479J-	R CARBON FILM	1/4 4.7 OHM J	
R829	RD-4Z479J-	R CARBON FILM	1/4 4.7 OHM J	
R831	RD-4Z105J-	R CARBON FILM	1/4 1M OHM J	
R837	RD-4Z331J-	R CARBON FILM	1/4 330 OHM J	
R838	RD-4Z333J-	R CARBON FILM	1/4 33K OHM J	
R848	RD-4Z102J-	R CARBON FILM	1/4 1K OHM J	
R853	RD-4Z223J-	R CARBON FILM	1/4 22K OHM J	
R855	RD-4Z102J-	R CARBON FILM	1/4 1K OHM J	
R885	RC-2Z565KP	R CARBON COMP	1/2 5.6M OHM K	
RS805	RD-4Z100J-	R CARBON FILM	1/4 10 OHM J	
RS806	RD-2Z129J-	R CARBON FILM	1/2 1.2 OHM J	
ZZ330	PTUNSWG151	PCB UNION AS	DLP-26C3AMBS	
100	2193110012	SOLDER WIRE	SAC3000 .03.0MM (LFA3C0-W3.0)	
200	2193110024	SOLDER WIRE	SAC3005 .01.6MM (LFA3-107-W1.6)	
300	2291050623	FLUX SOLDER LF	SV-PBF-304P (0.823)	
400	2291050312	FLUX SOLVENT	S-3000	
IC290	1TSOP34838	IC PREAMP	TSOP34838SJ	
LED1	DSPR39MVV-	LED	SPR-39MVV (DUAL)	
M232	4852333201	PANEL CTRL	HIPS BK	
M491	4854964311	BUTTON CH	ABS GY	
M491A	7178301051	SCREW TAPPTITE	TT2 WAS 3X10 M FZN 3CR	
P911C	4850705M40	CONNECTOR	12505HS-06+12505HS-06+ULW+CORE=600	
P912C	4850706N26	CONNECTOR	12505HS-06+12505HS-06+ULW+CORE=550	
ZZ200	PTUNJRG151	PCB UNION RADIAL AS	DLP-26C3AMBS	
SW201	5S50101Z90	SW TACT	THVV502GDA	
SW202	5S50101Z90	SW TACT	THVV502GDA	
SW203	5S50101Z90	SW TACT	THVV502GDA	
SW204	5S50101Z90	SW TACT	THVV502GDA	
SW205	5S50101Z90	SW TACT	THVV502GDA	
SW206	5S50101Z90	SW TACT	THVV502GDA	
SW207	5S50101Z90	SW TACT	THVV502GDA	
ZZ200	PTUNJ1G151	PCB UNION CHIP A AS	DLP-26C3AMBS	
110	2193220010	SOLDER CREAM(PB-FREE)	LST309-M/(SN-3.0AG/0.5CU)	
A001	4859814760	PCB UNION	189X235.5	
CC293	HCBK104KBA	C CHIP CERA	50V X7R 0.1MF K 1608	
PW201	49590009S0	CONN WAFER	12505WR-05A00	
PW202	49590001S0	CONN WAFER	12505WR-06A00	
RC270	HRFT432JBA	R CHIP	1/10 4.3K OHM J 1608	
RC271	HRFT152JBA	R CHIP	1/10 1.5K OHM J 1608	
RC272	HRFT152JBA	R CHIP	1/10 1.5K OHM J 1608	
RC273	HRFT432JBA	R CHIP	1/10 4.3K OHM J 1608	
RC274	HRFT113JBA	R CHIP	1/10 11K OHM J 1608	

Part List

DLP-26C2

LOC	PART NAME	PART DESCRIPTION	DLP-26C3	DLP-26C2
A001	PCB UNION	122.5X51(330X246/2X4) D1B		PTUNJAG117
A001	PCB UNION	189X235.5	PTUNJ1G151	
C996	C CERA	50V F 0.1MF Z AXL(1608)		PTUNJAG117
CC293	C CHIP CERA	50V X7R 0.1MF K 1608	PTUNJ1G151	
IC290	IC PREAMP	TSOP34838SJ	PTUNSWG151	
IC703	IC PREAMP	TSOP34838SJ		PTUNSWG117
M191	COVER ASSY	C2 STAND SUB ASSY		PTSNSWG117
M201	MASK FRONT	HIPS BK	PTFMSJG146	
M201	MASK FRONT	HIPS GY		PTFMSJG117
M201A	CUSION PANEL	PVC 400 X 10 T=1.0		PTFMSJG117
M201B	CUSION PANEL	PVC 300 X 10 T=1.0		PTFMSJG117
M201C	CLAMP WIRE	EGI T0.4+TUBE+PIE 3.2	PTCACAG151	
M201D	SCREW TAPPTITE	TT2 BIN 3X10 MFZN BK 3CR	PTCACAG151	
M211	COVER BACK	HIPS BK	PTBCSHG149	
M211	COVER BACK	HIPS BK		PTBCSHG117
M211A	SCREW TAPPTITE	TT2 TRS 4X14 MFZN BK 3CR	PTBCSHG149	PTBCSHG117
M211B	SCREW TAPPTITE	TT2 TRS 4X14 MFZN BK 3CR	PTBCSHG149	PTBCSHG117
M211C	CLOTH BLACK	FELT 300X20X0.7		PTBCSHG117
M211D	CLOTH BLACK	FELT 300X15X1.0		PTBCSHG117
M211E	CLOTH BLACK	FELT 150X20X0.7		PTBCSHG117
M211F	CLOTH BLACK	FELT 220X12X2		PTBCSHG117
M213	COVER WIRE	ABS BK		PTBCSHG117
M213	COVER STAND BASE	HIPS BK	PTSNSWG118	
M232	PANEL CTRL	HIPS BK	PTUNSWG151	
M321	BRKT STAND	SECC T=1.6		PTCACAG117
M321	BRKT STAND	SECC T1.6	PTCACAG151	
M322	BRKT STAND BOX	SECC T=1.0		PTCACAG117
M322	BRKT STAND BOX	SECC T1.0	PTCACAG151	
M322A	SCREW TAPPTITE	TT2 TRS 4X14 MFZN BK 3CR	PTBCSHG149	PTBCSHG117
M381C	SCREW TAPPTITE	TT2 TRS 4X14 MFZN BK 3CR	PTCACAG151	PTCACAG117
M381G	SCREW MACHINE	TRS 4X8 MFZN BK 3CR		PTCACAG117
M381G	SCREW MACHINE	BIN 4X10 MFZN BK 3CR	PTCACAG151	
M383	FRAME STAND	ABS BK	PTSNSWG118	
M383A	SCREW MACHINE	TRS 4X8 MFZN BK 3CR		PTCACAG117
M383A	SCREW MACHINE	BIN 4X10 MFZN BK 3CR	PTCACAG151	
M383A	SCREW TAPPTITE	TT2 TRS 4X14 MFZN BK 3CR	PTSNSWG118	
M383B	SCREW TAPPTITE	TT2 TRS 4X14 MFZN BK 3CR		PTCACAG117
M383B	SCREW TAPPTITE	TT2 TRS 4X16 MFZN BK 3CR	PTCACAG151	
M384	FRAME STAND	ABS GY		PTSNSWG117
M481	BUTTON POWER B	GPPS CL		PTUNSWG117
M481A	SCREW TAPPTITE	TT2 WAS 3X10 MFZN BK 3CR		PTUNSWG117
M491	BUTTON CH	ABS GY		PTUNSWG117
M491	BUTTON CH	ABS GY	PTUNSWG151	
M491A	SCREW TAPPTITE	TT2 WAS 3X10 MFZN 3CR	PTUNSWG151	
M491A	SCREW TAPPTITE	TT2 WAS 3X8 MFZN 3CR		PTUNSWG117
M491B	SCREW TAPPTITE	TT2 WAS 3X10 MFZN BK 3CR		PTUNSWG117
M521	PLATE BASE STAND	SECC T2.0	PTSNSWG118	
M521A	SCREW TAPPTITE	TT2 TRS 4X14 MFZN BK 3CR		PTSNSWG117
M521A	SCREW TAPPING	FLT 4X10 MFZN 3CR	PTSNSWG118	
M521C	RUBBER BOTTOM	CR60 BK PHI 18.0 X T 3.0	PTSNSWG118	
M551	DECO SENSOR	PC GY		PTUNSWG117
M551A	SCREW TAPPTITE	TT2 WAS 3X10 MFZN BK 3CR		PTUNSWG117
M561	MARK BRAND	SILVER DIA-CUTTING(DOUBLE FACED TAPE)L=80,P=30	PTFMSJG146	
M561	MARK BRAND	SILVER DIA-CUTTING		PTFMSJG117
M591	DECO PLATE	PC T2.0	PTFMSJG146	
M681	CLAMP WIRE	NYLON 66	PTACPPWG151	
M721A	SCREW TAPPTITE	TT2 BIN 3X10 MFZN BK 3CR	PTCACAG151	
M721A	SCREW TAPPTITE	TT2 WAS 3X10 MFZN BK 3CR		PTCACAG117
M723A	SCREW TAPPTITE	TT2 BIN 3X10 MFZN BK 3CR	PTCACAG151	
M723A	SCREW TAPPTITE	TT2 WAS 3X10 MFZN BK 3CR		PTCACAG117
M723B	SCREW TAPPTITE	TT2 BIN 3X10 MFZN BK 3CR	PTCACAG151	
M723B	SCREW TAPPTITE	TT2 WAS 3X10 MFZN BK 3CR		PTCACAG117
M801	BOX CARTON	DW-3	PTPKCPG146	
M801	BOX CARTON	DW-3		PTPKCPG117
M811	PAD	EPS	PTPKCPG146	
M811	PAD	EPS		PTPKCPG117
M822	BAG P.E	PE FOAM 10.5x1050x950	PTPKCPG146	
M822	BAG P.E	PE FOAM 10.5x1600x1270		PTPKCPG117

LOC	PART NAME	PART DESCRIPTION	DLP-26C3	DLP-26C2
P801A	CORD POWER AS	EU LP-33+LS-60=2.0M(LF)		PTACPPWG116
P801A	CORD POWER AS	EU LP-33+LS-60L=2.0M(LF)	PTACPPWG151	
P911A	CONN WAFER	20017WR-05A		PTUNSWG117
P911C	CONNECTOR	12505HS-05+12505HS-05+ULW+CORE=600	PTUNSWG151	
P911C	CONNECTOR	20017HR-05+12505HS-05+ULW+CORE=600		PTCACAG117
P912A	CONN WAFER	20017WR-06A		PTUNSWG117
P912C	CONNECTOR	12505HS-06+12505HS-06+ULW+CORE=550	PTUNSWG151	
P912C	CONNECTOR	20017HR-06+12505HS-06+ULW+CORE=700		PTCACAG117
PW201	CONN WAFER	12505WR-05A00	PTUNJ1G151	
PW202	CONN WAFER	12505WR-06A00	PTUNJ1G151	
R201	WIRE COPPER	1/0.6 TIN COATING		PTUNJAG117
R202	R CARBON FILM	1/6 1.5K OHM J		PTUNJAG117
R203	R CARBON FILM	1/6 4.3K OHM J		PTUNJAG117
R204	WIRE COPPER	1/0.6 TIN COATING		PTUNJAG117
R205	R CARBON FILM	1/6 1.5K OHM J		PTUNJAG117
R206	R CARBON FILM	1/6 4.3K OHM J		PTUNJAG117
R207	R CARBON FILM	1/6 11K OHM J		PTUNJAG117
RC270	R CHIP	1/10 4.3K OHM J 1608	PTUNJ1G151	
RC271	R CHIP	1/10 1.5K OHM J 1608	PTUNJ1G151	
RC272	R CHIP	1/10 1.5K OHM J 1608	PTUNJ1G151	
RC273	R CHIP	1/10 4.3K OHM J 1608	PTUNJ1G151	
RC274	R CHIP	1/10 11K OHM J 1608	PTUNJ1G151	
SP01	SPEAKER	SP-45165F01C	PTSPPWG151	
SP01	SPEAKER	SP-57165F01C		PTSPPWG117
SP02	SPEAKER	SP-45165F01C	PTSPPWG151	
SP02	SPEAKER	SP-57165F01C		PTSPPWG117

Part List

DLP-32C1

LOC	PART NAME	PART DESCRIPTION	DLP-26C3	DLP-32C1
M191A	SCREW TAPPTITE	TT2 WAS 3X10 MFZN BK 3CR		PTCACAG155
M201	MASK FRONT	HIPS BK	PTFMSJG146	
M201	MASK FRONT	HIPS BK		PTFMSJG155
M201B	SCREW TAPPTITE	TT2 BIN 3X10 MFZN BK 3CR		PTCACAG155
M201D	SCREW TAPPTITE	TT2 BIN 3X10 MFZN BK 3CR	PTCACAG151	
M201D	SCREW TAPPTITE	TT2 TRS 4X14 MFZN BK 3CR		PTCACAG155
M207	SHEET MICRO FIBER	180X180 T=0.7		PTACPWG155
M207A	SHEET MICRO FIBER	180X180 T=0.7		PTCACAG155
M211	COVER BACK	HIPS BK	PTBCSHG149	
M211	COVER BACK	HIPS BK		PTBCSHG155
M211A	SCREW TAPPTITE	TT2 TRS 4X14 MFZN BK 3CR	PTBCSHG149	PTCACAG155
M211B	SCREW TAPPTITE	TT2 TRS 4X14 MFZN BK 3CR	PTBCSHG149	
M211B	SCREW TAPPTITE	TT2 TRS 4X16 MFZN BK 3CR		PTCACAG155
M211C	SCREW TAPPTITE	TT2 TRS 4X14 MFZN BK 3CR		PTCACAG155
M211D	CLOTH BLACK	FELT T0.7 L=350 W=15		PTBCSHG155
M213	COVER STAND BASE	HIPS BK	PTSNSWG118	
M213	COVER STAND BASE	ABS BK(URETHANE SPRAY)		PTSNSWG155
M231	PANEL FRONT	ABS+PMMA BK		PTFMSJG155
M231A	SCREW TAPPTITE	TT2 WAS 3X12 MFZN BK 3CR		PTFMSJG155
M231B	PROTECTOR FILM	PE FILM (EVA) 52WX200MX0.05T		PTFMSJG155
M322	FRAME WALL KIT	SECC T=2.0	PTBCSHG149	
M322A	SCREW TAPPTITE	TT2 TRS 4X14 MFZN BK 3CR	PTBCSHG149	PTCACAG155
M322B	SCREW TAPPTITE	TT2 TRS 4X14 MFZN BK 3CR		PTCACAG155
M381	FRAME MAIN PCB	SECC T=1.0	PTDGMMSG117	
M381	FRAME MAIN PCB	SECC T=1.2 (A-2 : 32C1/32C3)		PTDGMMSG155
M381A	SCREW TAPPTITE	TT2 WAS 3X10 MFZN BK 3CR		PTDGMMSG155
M381C	SCREW MACHINE	WAS 3X8 MFZN 3CR		PTDGMMSG155
M381C	SCREW TAPPTITE	TT2 TRS 4X14 MFZN BK 3CR	PTCACAG151	
M381D	SCREW TAPPTITE	TT2 WAS 3X10 MFZN BK 3CR	PTDGMMSG117	
M381E	CLAMP WIRE	EGI T0.4+TUBE+PIE 3.2		PTDGMMSG155
M381E	SCREW MACHINE	WAS 3X8 MFZN 3CR	PTDGMMSG117	
M381E	SCREW MACHINE	TRS 4X8 MFZN BK 3CR		PTCACAG155
M381F	CLAMP WIRE	WS-A-2-19	PTDGMMSG117	PTDGMMSG155
M381G	SCREW MACHINE	BIN 4X10 MFZN BK 3CR	PTCACAG151	
M382	FRAME BAR	SECC T=1.2 (A-1 : AUO,SSE PANEL)		PTCACAG155
M382A	SCREW MACHINE	TRS 4X8 MFZN BK 3CR		PTCACAG155
M382B	SCREW TAPPTITE	TT2 TRS 4X14 MFZN BK 3CR		PTCACAG155
M383	FRAME BAR	SECC T=1.2 (A-1 : AUO,SSE PANEL)	PTCACAG151	
M383A	SCREW MACHINE	BIN 4X10 MFZN BK 3CR	PTCACAG151	
M383A	SCREW TAPPTITE	TT2 TRS 4X14 MFZN BK 3CR	PTSNSWG118	
M383B	SCREW TAPPTITE	TT2 TRS 4X16 MFZN BK 3CR	PTCACAG151	
M384	FRAME WALL KIT	SECC T=2.0		PTBCSHG155
M384A	SCREW TAPPTITE	TT2 TRS 4X14 MFZN BK 3CR		PTBCSHG155
M491B	SCREW TAPPTITE	TT2 TRS 4X14 MFZN BK 3CR		PTCACAG155
M521A	SCREW TAPPTITE	TT2 TRS 4X14 MFZN BK 3CR		PTSNSWG155
M521A	SCREW TAPPING	FLT 4X10 MFZN 3CR	PTSNSWG118	
M521B	SCREW TAPPING	FLT 4X10 MFZN 3CR		PTSNSWG155
M561	MARK BRAND	SILVER DIA-CUTTING(DOUBLE FACED TAPE)L=80P=30	PTFMSJG146	
M561	MARK BRAND	SILVER DIA-CUTTING(DOUBLE FACED TAPE)L=85P=30		PTFMSJG155
M591	DECO PLATE	PC T2.0		PTFMSJG155
M591	DECO PLATE	PC T2.0	PTFMSJG146	
M721A	SCREW TAPPTITE	TT2 BIN 3X10 MFZN BK 3CR	PTCACAG151	
M723B	SCREW TAPPTITE	TT2 BIN 3X10 MFZN BK 3CR	PTCACAG151	PTCACAG155
M801	BOX CARTON	DW-3	PTPKCPG146	
M801	BOX CARTON	DW-3		PTPKCPG155
M811	PAD	EPS	PTPKCPG146	
M811	PAD	EPS		PTPKCPG155
M822	BAG P.E	PE FOAM 10.5X11050X950	PTPKCPG146	
M822	BAG P.E	P.E FOAM T0.5X1100X950		PTPKCPG155
P801A	CORD POWER AS	EU LP-33+LS-60=2.0M(LF)		PTACPWG155
P801A	CORD POWER AS	EU LP-33+LS-60L=2.0M(LF)	PTACPWG151	
V901	LCD PANEL	T260XW02 V5	PTCACAG151	
V901	LCD PANEL	T315XW01-V5		PTCACAG155

DLP-32C2

LOC	PART NAME	PART DESCRIPTION	DLP-26C3	DLP-32C2
A001	PCB UNION	122.5X51(330X246/2X4) D1B		PTUNJAG117
A001	PCB UNION	189X235.5		PTUNJAG151
C996	C CERA	50V F 0.1MF Z AXL(1608)		PTUNJAG117
CC293	C CHIP CERA	50V X7R 0.1MF K 1608		PTUNJAG151
IC290	IC PREAMP	TSOP34838SJ		PTUNSWG151
IC703	IC PREAMP	TSOP34838SJ		PTUNSWG117
M191	COVER ASSY	C2 STAND SUB ASSY		PTSNSWG116
M201	MASK FRONT	HIPS BK	PTFMSJG146	
M201	MASK FRONT	HIPS GY		PTFMSJG116
M201A	CUSION PANEL	PVC 400 X 10 T=1.0		PTFMSJG116
M201B	CUSION PANEL	PVC 300 X 10 T=1.0		PTFMSJG116
M201C	CLAMP WIRE	EGI T0.4+TUBE+PIE 3.2		PTCACAG151
M201D	SCREW TAPPTITE	TT2 BIN 3X10 MFZN BK 3CR		PTCACAG151
M211	COVER BACK	HIPS BK	PTBCSHG149	
M211	COVER BACK	HIPS BK		PTBCSHG116
M211B	CLOTH BLACK	FELT 300X20X0.7		PTBCSHG116
M211B	SCREW TAPPTITE	TT2 TRS 4X14 MFZN BK 3CR	PTBCSHG149	
M211C	CLOTH BLACK	FELT 200X20X0.7		PTBCSHG116
M211D	CLOTH BLACK	FELT 400X20X0.7		PTBCSHG116
M211E	SCREW TAPPTITE	TT2 TRS 4X14 MFZN BK 3CR		PTBCSHG116
M211F	CLOTH BLACK	FELT 220X12X2		PTBCSHG116
M213	COVER WIRE	ABS BK		PTBCSHG116
M213	COVER STAND BASE	HIPS BK	PTSNSWG118	
M232	PANEL CTRL	HIPS BK	PTUNSWG151	
M321	BRKT STAND	SECC T=1.6		PTCACAG116
M321	BRKT STAND	SECC T1.6		PTCACAG151
M321A	SCREW TAPPTITE	TT2 TRS 4X12 MFZN BK 3CR		PTDGMMSG116
M321A	SCREW TAPPTITE	TT2 TRS 4X14 MFZN BK 3CR	PTCACAG151	PTCACAG116
M322	BRKT STAND BOX	SECC T=1.0		PTCACAG116
M322	BRKT STAND BOX	SECC T1.0		PTCACAG151
M322A	SCREW TAPPTITE	TT2 TRS 4X14 MFZN BK 3CR	PTBCSHG149	PTBCSHG116
M381	FRAME MAIN PCB	SECC T=1.0	PTDGMMSG117	
M381	FRAME MAIN PCB	SECC T=1.2 (A-2 : 32C1/32C3)		PTDGMMSG116
M381D	SCREW TAPPTITE	TT2 WAS 3X10 MFZN BK 3CR	PTDGMMSG117	PTDGMMSG116
M381F	CLAMP WIRE	WS-A-2-19	PTDGMMSG117	PTDGMMSG116
M381G	SCREW MACHINE	TRS 4X8 MFZN BK 3CR		PTCACAG116
M381G	SCREW MACHINE	BIN 4X10 MFZN BK 3CR	PTCACAG151	
M382C	CLAMP WIRE	WS-A-2-19		PTDGMMSG116
M383	FRAME BAR	SECC T=1.2 (A-1 : AUO,SSE PANEL)	PTCACAG151	
M383	FRAME BAR	SECC T=1.2 (A-1 : AUO,SSE PANEL)		PTCACAG116
M383	FRAME STAND	ABS BK	PTSNSWG118	
M383A	SCREW MACHINE	TRS 4X8 MFZN BK 3CR		PTCACAG116
M383A	SCREW MACHINE	BIN 4X10 MFZN BK 3CR	PTCACAG151	
M383A	SCREW TAPPTITE	TT2 TRS 4X14 MFZN BK 3CR	PTSNSWG118	
M383B	SCREW TAPPTITE	TT2 TRS 4X14 MFZN BK 3CR		PTCACAG116
M383B	SCREW TAPPTITE	TT2 TRS 4X16 MFZN BK 3CR	PTCACAG151	
M384	FRAME STAND	ABS GY		PTSNSWG116
M481	BUTTON POWER B	GPPS CL		PTUNSWG117
M481A	SCREW TAPPTITE	TT2 WAS 3X10 MFZN BK 3CR		PTUNSWG117
M491	BUTTON CH	ABS GY		PTUNSWG117
M491	BUTTON CH	ABS GY	PTUNSWG151	
M491A	SCREW TAPPTITE	TT2 WAS 3X10 MFZN 3CR	PTUNSWG151	
M491A	SCREW TAPPTITE	TT2 WAS 3X8 MFZN 3CR		PTUNSWG117
M491B	SCREW TAPPTITE	TT2 WAS 3X10 MFZN BK 3CR		PTUNSWG117
M521	PLATE BASE STAND	SECC T2.0		PTSNSWG118
M521A	SCREW TAPPTITE	TT2 TRS 4X14 MFZN BK 3CR		PTSNSWG116
M521A	SCREW TAPPING	FLT 4X10 MFZN 3CR	PTSNSWG118	
M521C	RUBBER BOTTOM	CR60 BK PHI 18.0 X T 3.0		PTSNSWG118
M551	DECO SENSOR	PC GY		PTUNSWG117
M551A	SCREW TAPPTITE	TT2 WAS 3X10 MFZN BK 3CR		PTUNSWG117
M561	MARK BRAND	SILVER DIA-CUTTING(DOUBLE FACED TAPE)L=80P=30	PTFMSJG146	
M561	MARK BRAND	SILVER DIA-CUTTING		PTFMSJG116
M591	DECO PLATE	PC T2.0	PTFMSJG146	
M681	CLAMP WIRE	NYLON 66	PTACPWG151	
M721A	SCREW TAPPTITE	TT2 BIN 3X10 MFZN BK 3CR	PTCACAG151	
M721A	SCREW TAPPTITE	TT2 WAS 3X10 MFZN BK 3CR		PTCACAG116
M723A	SCREW TAPPTITE	TT2 BIN 3X10 MFZN BK 3CR	PTCACAG151	
M723A	SCREW TAPPTITE	TT2 WAS 3X10 MFZN BK 3CR		PTCACAG116

Part List

DLP-32C3

LOC	PART NAME	PART DESCRIPTION	DLP-26C3	DLP-32C2
M723B	SCREW TAPPTITE	TT2 BIN 3X10 MFZN BK 3CR	PTCACAG151	
M723B	SCREW TAPPTITE	TT2 WAS 3X10 MFZN BK 3CR		PTCACAG116
M801	BOX CARTON	DW-3	PTPKCPG146	
M801	BOX CARTON	DW-3		PTPKCPG116
M811	PAD	EPS	PTPKCPG146	
M811	PAD	EPS		PTPKCPG116
M822	BAG P.E	PE FOAM 10.5x1050x950	PTPKCPG146	
M822	BAG P.E	PE FOAM 10.5x1600x1270		PTPKCPG116
P801A	CORD POWER AS	EU LP-33+LS-60=2.0M(LF)		PTACPWG116
P801A	CORD POWER AS	EU LP-33+LS-60L=2.0M(LF)	PTACPWG151	
P911A	CONN WAFER	20017WR-05A		PTUNSWG117
P911C	CONNECTOR	12505HS-05+12505HS-05+ULW+CORE=600	PTUNSWG151	
P911C	CONNECTOR	20017HR-05+12505HS-05+ULW+CORE=600		PTCACAG116
P912A	CONN WAFER	20017WR-06A		PTUNSWG117
P912C	CONNECTOR	12505HS-06+12505HS-06+ULW+CORE=550	PTUNSWG151	
P912C	CONNECTOR	20017HR-06+12505HS-06+ULW+CORE=700		PTCACAG116
PW201	CONN WAFER	12505WR-05A00	PTUNJ1G151	
PW202	CONN WAFER	12505WR-06A00	PTUNJ1G151	
R201	WIRE COPPER	1/0.6 TIN COATING		PTUNJAG117
R202	R CARBON FILM	1/6 1.5K OHM J		PTUNJAG117
R203	R CARBON FILM	1/6 4.3K OHM J		PTUNJAG117
R204	WIRE COPPER	1/0.6 TIN COATING		PTUNJAG117
R205	R CARBON FILM	1/6 1.5K OHM J		PTUNJAG117
R206	R CARBON FILM	1/6 4.3K OHM J		PTUNJAG117
R207	R CARBON FILM	1/6 11K OHM J		PTUNJAG117
RC270	R CHIP	1/10 4.3K OHM J 1608	PTUNJ1G151	
RC271	R CHIP	1/10 1.5K OHM J 1608	PTUNJ1G151	
RC272	R CHIP	1/10 1.5K OHM J 1608	PTUNJ1G151	
RC273	R CHIP	1/10 4.3K OHM J 1608	PTUNJ1G151	
RC274	R CHIP	1/10 11K OHM J 1608	PTUNJ1G151	
SP01	SPEAKER	SP-45165F01C	PTSPPWG151	
SP01	SPEAKER	SP-57165F01C		PTSPPWG116
SP02	SPEAKER	SP-45165F01C	PTSPPWG151	
SP02	SPEAKER	SP-57165F01C		PTSPPWG116
V901	LCD PANEL	T260XW02 V5	PTCACAG151	
V901	LCD PANEL	T315XW01-V5		PTCACAG116

LOC	PART NAME	PART DESCRIPTION	DLP-26C3	DLP-32C3
M201	MASK FRONT	HIPS BK	PTFMSJG146	
M201	MASK FRONT	HIPS BK		PTFMSJG147
M201B	SCREW TAPPTITE	TT2 BIN 3X10 MFZN BK 3CR		PTCACAG152
M201C	CLAMP WIRE	EGI T0.4+TUBE+PIE 3.2	PTCACAG151	
M201C	SCREW TAPPTITE	TT2 BIN 3X10 MFZN BK 3CR		PTCACAG152
M201D	SCREW TAPPTITE	TT2 BIN 3X10 MFZN BK 3CR	PTCACAG151	
M201E	SCREW MACHINE	BIN 4X10 MFZN BK 3CR		PTCACAG152
M201F	CLAMP WIRE	EGI T0.4+TUBE+PIE 4.2		PTCACAG152
M211	COVER BACK	HIPS BK	PTBCSHG149	
M211	COVER BACK	HIPS BK		PTBCSHG147
M211A	CLOTH BLACK	FELT T0.7 L=350 W=15		PTBCSHG147
M211A	SCREW TAPPTITE	TT2 TRS 4X14 MFZN BK 3CR	PTBCSHG149	PTCACAG152
M211B	SCREW TAPPTITE	TT2 TRS 4X14 MFZN BK 3CR	PTBCSHG149	
M211B	SCREW TAPPTITE	TT2 TRS 4X16 MFZN BK 3CR		PTCACAG152
M211C	SCREW TAPPTITE	TT2 TRS 4X14 MFZN BK 3CR		PTCACAG152
M321A	SCREW TAPPTITE	TT2 TRS 4X12 MFZN BK 3CR		PTDGMSG116
M321A	SCREW TAPPTITE	TT2 TRS 4X14 MFZN BK 3CR	PTCACAG151	PTCACAG152
M322	FRAME WALL KIT	SECC T=2.0	PTBCSHG149	
M322A	SCREW TAPPTITE	TT2 TRS 4X14 MFZN BK 3CR	PTBCSHG149	PTCACAG152
M322B	SCREW TAPPTITE	TT2 TRS 4X14 MFZN BK 3CR		PTCACAG152
M381	FRAME MAIN PCB	SECC T=1.0	PTDGMSG117	
M381	FRAME MAIN PCB	SECC T=1.2 (A-2 : 32C1/32C3)		PTDGMSG116
M381C	SCREW TAPPTITE	TT2 TRS 4X14 MFZN BK 3CR	PTCACAG151	
M381D	SCREW TAPPTITE	TT2 WAS 3X10 MFZN BK 3CR	PTDGMSG117	PTDGMSG116
M381F	CLAMP WIRE	WS-A-2-19	PTDGMSG117	PTDGMSG116
M381G	SCREW MACHINE	BIN 4X10 MFZN BK 3CR	PTCACAG151	
M382	FRAME BAR	SECC T=1.2 (A-1 : AUO,SSE PANEL)		PTCACAG152
M382A	SCREW MACHINE	BIN 4X10 MFZN BK 3CR		PTCACAG152
M382B	SCREW TAPPTITE	TT2 TRS 4X14 MFZN BK 3CR		PTCACAG152
M382C	CLAMP WIRE	WS-A-2-19		PTDGMSG116
M383	FRAME BAR	SECC T=1.2 (A-1 : AUO,SSE PANEL)	PTCACAG151	
M383A	SCREW MACHINE	BIN 4X10 MFZN BK 3CR	PTCACAG151	
M383B	SCREW TAPPTITE	TT2 TRS 4X16 MFZN BK 3CR	PTCACAG151	
M384	FRAME WALL KIT	SECC T=2.0		PTBCSHG147
M384A	SCREW TAPPTITE	TT2 TRS 4X14 MFZN BK 3CR		PTBCSHG147
M491B	SCREW TAPPTITE	TT2 TRS 4X14 MFZN BK 3CR		PTCACAG152
M561	MARK BRAND	SILVER DIA-CUTTING(DOUBLE FACED TAPE)L=80,P=30	PTFMSJG146	
M561	MARK BRAND	SILVER DIA-CUTTING(DOUBLE FACED TAPE)L=85,P=30		PTFMSJG147
M591	DECO PLATE	PC T2.0	PTFMSJG146	
M591	DECO PLATE	PC T2.0		PTFMSJG147
M723B	SCREW TAPPTITE	TT2 BIN 3X10 MFZN BK 3CR	PTCACAG151	PTCACAG152
M801	BOX CARTON	DW-3	PTPKCPG146	
M801	BOX CARTON	DW-3		PTPKCPG147
M811	PAD	EPS	PTPKCPG146	
M811	PAD	EPS		PTPKCPG147
M822	BAG P.E	PE FOAM 10.5x1050x950	PTPKCPG146	
M822	BAG P.E	P.E FOAM T0.5X1100X950		PTPKCPG147
V901	LCD PANEL	T260XW02 V5	PTCACAG151	
V901	LCD PANEL	T315XW01-V5		PTCACAG152

Part List

DLP-37C3

LOC	PART NAME	PART DESCRIPTION	DLP-26C3	DLP-37C3
00001	DIODE BRIDGE	GBJ606	PTA3SW2900	
00001	DIODE	FMX-22SL	PTB2SW4508	
00001	DIODE	FME-210B	PTC2SW4508	
00001	FET	STW20NM60	PTE2SW4508	
00001	IC POWER	STR-T2268	PTA3SW3100	
00001	IC SW REG	LA5752	PTA2SW4519	
0000A	HEAT SINK	AL EX BK	PTC2SW4508	
0000A	HEAT SINK	AL EX (NO ANODIZING)	PTA2SW4519	
0000A	HEAT SINK	AL EX	PTA3SW2900	
0000A	HEAT SINK	AL EX BK	PTA3SW3100	
0000B	SCREW TAPPTITE	TT2 RND 3X8 MFZN 3CR	PTA3SW2900	
0000B	INSU PLATE	SILICON RUBBER T0.3	PTE2SW4508	
0000C	SCREW TAPPTITE	TT2 RND 3X12 MFZN 3CR	PTE2SW4508	
100	SOLDER WIRE	SAC3000 Ø3.0MM (LFA3C0-W3.0)	PTDGMMSG117	PTDGMMSG140
200	SOLDER WIRE	SAC3005 Ø1.6MM (LFA3-107-W1.6)	PTDGMMSG117	PTDGMMSG140
300	FLUX SOLDER LF	SV-PBF-304P(0.823)	PTDGMMSG117	PTDGMMSG140
400	FLUX SOLVENT	S-3000	PTDGMMSG117	PTDGMMSG140
M192	COVER ASSY	STAND SUB ASSY (NORMAL SPRAY)		PTCACAG140
M201	MASK FRONT	HIPS BK	PTFMSJG146	
M201	MASK FRONT	HIPS BK		PTFMSJG140
M201A	CUSION PANEL	PVC 400 X 10 T=1.0		PTFMSJG140
M201A	SCREW TAPPTITE	TT2 WAS 3X10 MFZN 3CR		PTUNSWG140
M201C	CLAMP WIRE	EGI T0.4+TUBE+PIE 3.2	PTCACAG151	
M201D	SCREW TAPPTITE	TT2 BIN 3X10 MFZN BK 3CR	PTCACAG151	
M211	COVER BACK	HIPS BK	PTBCSHG149	
M211	COVER BACK	HIPS BK		PTBCSHG140
M211A	SCREW TAPPTITE	TT2 TRS 4X14 MFZN BK 3CR	PTBCSHG149	PTBCSHG140
M211B	SCREW MACHINE	TRS 4X14 MFZN BK 3CR		PTBCSHG140
M211B	SCREW TAPPTITE	TT2 TRS 4X14 MFZN BK 3CR	PTBCSHG149	
M212	COVER BOTTOM	ABS BK	PTACPWG151	
M212	COVER BOTTOM	HIPS BK		PTACPWG140
M213	COVER STAND BASE	HIPS BK	PTSNSWG118	
M321	BRKT POWER SW	SECC 1T	PTDGMMSG117	
M321	BRKT STAND	SECC T1.6	PTCACAG151	
M321	BRKT STAND	SECC T1.6		PTFMSJG140
M321A	SCREW TAPPTITE	TT2 TRS 4X14 MFZN BK 3CR	PTCACAG151	PTFMSJG140
M322	FRAME WALL KIT	SECC T=2.0	PTBCSHG149	
M322	BRKT STAND BOX	SECC T1.0	PTCACAG151	
M322	BRKT STAND BOX	SECC T1.0		PTFMSJG140
M322A	SCREW TAPPTITE	TT2 TRS 4X14 MFZN BK 3CR	PTBCSHG149	PTFMSJG140
M323	BRKT POWER SW	SECC 1T	PTCACAG140	
M381	FRAME MAIN PCB	SECC T=1.0	PTDGMMSG117	
M381	PLATE LOWER	SECC, T=1.2		PTDGMMSG140
M381A	SCREW TAPPTITE	TT2 WAS 3X10 MFZN 3CR		PTDGMMSG140
M381B	SCREW TAPPTITE	TT2 WAS 3X10 MFZN 3CR		PTDGMMSG140
M381C	SCREW TAPPTITE	TT2 WAS 3X10 MFZN 3CR		PTDGMMSG140
M381C	SCREW TAPPTITE	TT2 TRS 4X14 MFZN BK 3CR	PTCACAG151	
M381D	SCREW MACHINE	WAS 3X8 MFZN 3CR		PTDGMMSG140
M381D	SCREW TAPPTITE	TT2 WAS 3X10 MFZN BK 3CR	PTDGMMSG117	
M381E	CLAMP WIRE	EGI T0.4+TUBE+PIE 3.2		PTDGMMSG140
M381E	SCREW MACHINE	WAS 3X8 MFZN 3CR	PTDGMMSG117	
M381F	CLAMP WIRE	WS-A-2-19	PTDGMMSG117	
M381G	SCREW MACHINE	BIN 4X10 MFZN BK 3CR	PTCACAG151	
M381H	RETA PCB	NYLON 66	PTDGMMSG117	
M382	FRAME SURPORT	SECC T1.2		PTCACAG140
M382A	SCREW MACHINE	TRS 4X8 MFZN BK 3CR		PTCACAG140
M383	FRAME BAR	SECC T=1.2 (A-1 : AUO,SSE PANEL)	PTCACAG151	
M383	FRAME SIDE T	SECC T1.2 (LPL)		PTCACAG140
M383	FRAME STAND	ABS BK	PTSNSWG118	
M383A	SCREW MACHINE	BIN 4X10 MFZN BK 3CR	PTCACAG151	
M383A	SCREW TAPPTITE	TT2 TRS 4X14 MFZN BK 3CR	PTSNSWG118	PTCACAG140
M383B	SCREW TAPPTITE	TT2 TRS 4X14 MFZN BK 3CR		PTCACAG140
M383B	SCREW TAPPTITE	TT2 TRS 4X16 MFZN BK 3CR	PTCACAG151	
M384	FRAME SIDE B	SECC T1.6 (LPL)		PTCACAG140
M384A	SCREW TAPPTITE	TT2 TRS 4X14 MFZN BK 3CR		PTCACAG140
M384B	SCREW TAPPTITE	TT2 TRS 4X14 MFZN BK 3CR		PTCACAG140
M384C	CLAMP WIRE	EGI T0.4+TUBE+PIE 3.2		PTCACAG140
M385	FRAME SIDE L/R	SECC T1.2 (LPL)		PTCACAG140

LOC	PART NAME	PART DESCRIPTION	DLP-26C3	DLP-37C3
M385A	SCREW TAPPTITE	TT2 TRS 4X14 MFZN BK 3CR		PTCACAG140
M387	FRAME STAND	ABS BK		PTCACAG140
M387A	SCREW TAPPTITE	TT2 TRS 4X14 MFZN BK 3CR		PTCACAG140
M388	FRAME WALL KIT	SECC T=2.0		PTBCSHG140
M388A	SCREW TAPPTITE	TT2 TRS 4X14 MFZN BK 3CR		PTBCSHG140
M491B	SCREW TAPPTITE	TT2 TRS 4X14 MFZN BK 3CR		PTUNSWG140
M521	PLATE BASE STAND	SECC T2.0	PTSNSWG118	
M521A	SCREW TAPPING	FLT 4X10 MFZN 3CR	PTSNSWG118	
M521C	RUBBER BOTTOM	CR60 BK PHI 18.0 X T 3.0	PTSNSWG118	
M561	MARK BRAND	SILVER DIA-CUTTING(DOUBLE FACED TAPE) L=80,P=30	PTFMSJG146	
M561	MARK BRAND	SILVER DIA-CUTTING(DOUBLE FACED TAPE) L=90.5,P=30		PTFMSJG140
M591	DECO PLATE	PC T2.0	PTFMSJG146	
M591	DECO PLATE	PC T2.0		PTFMSJG140
P501	CONN WAFER	GT121-31P-TD-A 31P ST		PTDGJ1G140
P501A	CABLE LVDS	1001-31FC-N+FH10001-30+42C1LMR=400		PTCACAG140
P520	CONN WAFER	GT121-31P-TD-A 31P ST		PTDGJ1G117
P520A	CABLE LVDS	1001-31FC-N+FH10002-30+3212APSB=300		PTCACAG151
P625	CONNECTOR	SMH250-02+YRT205+YRT110+USW=1000		PTSPPWG151
P626	CONNECTOR	SMH250-03+YRT205+YRT110+USW=1000		PTSPPWG151
P801	SOCKET AC	0714-CP7N		PTSKSWG084
P802	CONN WAFER	YW025-08 (STICK)		PTPWJBG116
P803	CONN WAFER	SMW200-14P		PTPWMSG116
P803B	CONNECTOR	20022HS-12S+20022HS-12S+ULW=800		PTCACAG140
P803B	CONNECTOR	20022HS-14S+SMH200-14P+ULW=300		PTCACAG151
P803C	CONNECTOR	20022HS-12S+20022HS-12S+ULW=300		PTCACAG140
P911C	CONNECTOR	12505HS-05+12505HS-05+ULW+CORE=600		PTUNSWG151
P911C	CONNECTOR	12505HS-05+12505HS-05+ULW+CORE=800		PTUNSWG140
PW1	CONN WAFER	12505WS-10A00		PTDGJ1G140
RC401	R CHIP	1/10 0 OHM J 1608		PTDGJ1G140
RC402	R CHIP	1/10 0 OHM J 1608		PTDGJ1G117
RC514	R CHIP	1/10 3.3K OHM J 1608		PTDGJ1G117
RC515	R CHIP	1/10 3.3K OHM J 1608		PTDGJ1G140
SP01	SPEAKER SYSTEM	SS-57165F01CR		PTCACAG140
SP01	SPEAKER	SP-45165F01C		PTSPPWG151
SP02	SPEAKER SYSTEM	SS-57165F01CL		PTCACAG140
SP02	SPEAKER	SP-45165F01C		PTSPPWG151
SP03A	SCREW TAPPTITE	TT2 WAS 3X10 MFZN 3CR		PTCACAG140
SP04A	SCREW TAPPTITE	TT2 WAS 3X10 MFZN 3CR		PTCACAG140
V901	LCD PANEL	T260XW02 V5		PTCACAG151
V901	LCD PANEL	LC370WX1-SL01		PTCACAG140
V902	MODULE POWER	FEL-3237UB		PTDGMMSG140

Part List

DLP-42C1

LOC	PART NAME	PART DESCRIPTION	DLP-26C3	DLP-42C1
00001	DIODE BRIDGE	GBJ606	PTA3SW2900	
00001	DIODE	FMX-22SL	PTB2SW4508	
00001	DIODE	FME-210B	PTC2SW4508	
00001	FET	STW20NM60	PTE2SW4508	
00001	IC POWER	STR-T2268	PTA3SW3100	
00001	IC SW REG	LA5752	PTA2SW4519	
0000A	HEAT SINK	AL EX BK	PTC2SW4508	
0000A	HEAT SINK	AL EX (NO ANODIZING)	PTA2SW4519	
0000A	HEAT SINK	AL EX	PTA3SW2900	
0000A	HEAT SINK	AL EX BK	PTA3SW3100	
0000B	SCREW TAPPTITE	TT2 RND 3X8 MFZN 3CR	PTA3SW2900	
0000B	INSU PLATE	SILICON RUBBER T0.3	PTE2SW4508	
0000C	SCREW TAPPTITE	TT2 RND 3X12 MFZN 3CR	PTE2SW4508	
100	SOLDER WIRE	SAC3000 ϕ3.0MM (LFA3C0-W3.0)	PTDGMMSG117	PTDGMMSG141
200	SOLDER WIRE	SAC3005 ϕ1.6MM (LFA3-107-W1.6)	PTDGMMSG117	PTDGMMSG141
300	FLUX SOLDER LF	SV-PBF-304P(0.823)	PTDGMMSG117	PTDGMMSG141
400	FLUX SOLVENT	S-3000	PTDGMMSG117	PTDGMMSG141
M191	SHIELD CASE AS	7255700+5944600	PTCACAG151	
M201	MASK FRONT	HIPS BK	PTFMSJG146	
M201	MASK FRONT	ABS BK		PTFMSJG141
M201B	SCREW TAPPTITE	TT2 BIN 3X10 MFZN BK 3CR		PTCACAG141
M201C	CLAMP WIRE	EGI T0.4+TUBE+PIE 3.2	PTCACAG151	
M201D	SCREW TAPPTITE	TT2 BIN 3X10 MFZN BK 3CR	PTCACAG151	
M211	COVER BACK	HIPS BK	PTBCSHG149	
M211	COVER BACK	ABS BK		PTBCSHG141
M211A	SCREW TAPPTITE	TT2 TRS 4X14 MFZN BK 3CR	PTBCSHG149	PTCACAG141
M211B	SCREW TAPPTITE	TT2 TRS 4X14 MFZN BK 3CR	PTBCSHG149	
M211B	SCREW TAPPTITE	TT2 TRS 4X16 MFZN BK 3CR		PTCACAG141
M212	COVER BOTTOM	ABS BK	PTACPWG151	
M212	COVER BOTTOM	HIPS BK		PTACPWG141
M213	COVER STAND BASE	HIPS BK	PTSNSWG118	
M231	PANEL FRONT	ABS+PMMA BK		PTFMSJG141
M231A	SCREW TAPPTITE	TT2 WAS 3X12 MFZN BK 3CR		PTFMSJG141
M321	BRKT POWER SW	SECC 1T	PTDGMMSG117	
M321	BRKT STAND	SECC T1.6	PTCACAG151	
M321	BRKT STAND	SECC, T=1.6		PTCACAG141
M321A	SCREW TAPPTITE	TT2 TRS 4X14 MFZN BK 3CR	PTCACAG151	PTCACAG141
M322	FRAME WALL KIT	SECC T=2.0	PTBCSHG149	
M322	BRKT STAND BOX	SECC T1.0	PTCACAG151	
M322	BRKT STAND BOX	SECC T1.0		PTCACAG141
M322A	SCREW TAPPTITE	TT2 TRS 4X14 MFZN BK 3CR	PTBCSHG149	PTCACAG141
M381	FRAME MAIN PCB	SECC T=1.0	PTDGMMSG117	
M381	PLATE LOWER	SECC, T=1.2		PTDGMMSG141
M381A	SCREW TAPPTITE	TT2 WAS 3X10 MFZN 3CR		PTDGMMSG141
M381B	SCREW TAPPTITE	TT2 WAS 3X10 MFZN 3CR		PTDGMMSG141
M381C	SCREW TAPPTITE	TT2 WAS 3X10 MFZN 3CR		PTDGMMSG141
M381C	SCREW TAPPTITE	TT2 TRS 4X14 MFZN BK 3CR	PTCACAG151	
M381D	SCREW TAPPTITE	TT2 WAS 3X10 MFZN 3CR		PTDGMMSG141
M381D	SCREW TAPPTITE	TT2 WAS 3X10 MFZN BK 3CR	PTDGMMSG117	
M381E	SCREW MACHINE	WAS 3X8 MFZN 3CR	PTDGMMSG117	
M381E	CLAMP WIRE	WS-A-2-19		PTDGMMSG141
M381F	CLAMP WIRE	WS-A-2-19	PTDGMMSG117	
M381G	SCREW MACHINE	BIN 4X10 MFZN BK 3CR	PTCACAG151	
M381H	RETA PCB	NYLON 66	PTDGMMSG117	
M382	FRAME SURPORT	SECC, T=1.2		PTCACAG141
M382A	SCREW MACHINE	TRS 4X8 MFZN BK 3CR		PTCACAG141
M383	FRAME BAR	SECC T=1.2 (A-1 : AUO,SSE PANEL)	PTCACAG151	
M383	FRAME SIDE T	SECC, T=1.2		PTCACAG141
M383	FRAME STAND	ABS BK	PTSNSWG118	
M383A	SCREW MACHINE	BIN 4X10 MFZN BK 3CR	PTCACAG151	
M383A	SCREW TAPPTITE	TT2 TRS 4X14 MFZN BK 3CR	PTSNSWG118	PTCACAG141
M383B	SCREW TAPPTITE	TT2 TRS 4X14 MFZN BK 3CR		PTCACAG141
M383B	SCREW TAPPTITE	TT2 TRS 4X16 MFZN BK 3CR	PTCACAG151	
M384	FRAME SIDE B	SECC, T=1.6		PTCACAG141
M384A	SCREW TAPPTITE	TT2 TRS 4X14 MFZN BK 3CR		PTCACAG141
M384B	SCREW TAPPTITE	TT2 TRS 4X14 MFZN BK 3CR		PTCACAG141
M384C	CLAMP WIRE	WS-A-2-19		PTCACAG141
M385	FRAME SIDE LR	SECC, T=1.2		PTCACAG141

LOC	PART NAME	PART DESCRIPTION	DLP-26C3	DLP-42C1
M385A	SCREW TAPPTITE	TT2 TRS 4X14 MFZN BK 3CR		PTCACAG141
M386	FRAME HORIZONTAL	SECC T=1.6		PTCACAG141
M386A	SCREW TAPPTITE	TT2 BIN 3X10 MFZN BK 3CR		PTCACAG141
M387	FRAME STAND	ABS BK		PTSNSWG138
M387A	SCREW TAPPTITE	TT2 TRS 4X14 MFZN BK 3CR		PTSNSWG138
M388	FRAME WALL KIT	SECC, T=1.6		PTBCSHG141
M388A	SCREW TAPPTITE	TT2 TRS 4X14 MFZN BK 3CR		PTBCSHG141
M491B	SCREW TAPPTITE	TT2 TRS 4X14 MFZN BK 3CR		PTCACAG141
M520	COVER ASSY	STAND SUB ASSY (URETHANE-SPRAY)		PTSNSWG138
M521	PLATE BASE STAND	SECC T2.0		PTSNSWG118
M521A	SCREW TAPPING	FLT 4X10 MFZN 3CR		PTSNSWG118
M521C	RUBBER BOTTOM	CR60 BK PHI 18.0 X T 3.0		PTSNSWG118
M561	MARK BRAND	SILVER DIA-CUTTING(DOUBLE FACED TAPE)L=80,P=30		PTFMSJG146
M561	MARK BRAND	SILVER DIA-CUTTING(DOUBLE FACED TAPE)L=90.5P=30		PTFMSJG141
M562	PROTECTOR FILM	PE FILM (EVA) 62WX200MX0.05T		PTFMSJG141
M591	DECO PLATE	PC T2.0		PTFMSJG146
M591	DECO PLATE	PC, T=2.0		PTFMSJG141
M681	BAND PP AUTO	T1.1XW17MMXL770M		PTPKCPG146
M683	SHEET MICRO FIBER	180X180 T=0.7		PTACPWG141
M720	BRKT POWER SW	SECC 1T		PTDGMMSG141
M720A	SCREW TAPPTITE	TT2 TRS 4X14 MFZN BK 3CR		PTDGMMSG141
M720B	SCREW TAPPTITE	TT2 TRS 4X14 MFZN BK 3CR		PTCACAG141
M721	SHIELD CASE AS	7255700+5944600		PTCACAG141
M721A	SCREW TAPPTITE	TT2 BIN 3X10 MFZN BK 3CR	PTCACAG151	PTCACAG141
M723B	SCREW TAPPTITE	TT2 BIN 3X10 MFZN BK 3CR	PTCACAG151	PTCACAG141
M801	BOX CARTON	DW-3		PTPKCPG146
M801	BOX CARTON	DW-3		PTPKCPG141
M811	PAD	EPS		PTPKCPG146
M811	PAD	EPS		PTPKCPG141
M822	BAG P.E	PE FOAM 10.5x1050x950		PTPKCPG146
M822	BAG P.E	PE FOAM T0.5X1430X1270		PTPKCPG141
P501	CONN WAFER	GT121-31P-TD-A 31P ST		PTDGJ1G141
P501A	CABLE LVDS	1001-31FC-N+FH10001-30+42C1LMR=400		PTCACAG141
P520	CONN WAFER	GT121-31P-TD-A 31P ST		PTDGJ1G117
P520A	CABLE LVDS	1001-31FC-N+FH10002-30+3212APSB=300		PTCACAG151
P625	CONNECTOR	SMH250-02+YRT205+YRT110+USW=1000		PTSPPWG151
P626	CONNECTOR	SMH250-03+YRT205+YRT110+USW=1000		PTSPPWG151
P801	SOCKET AC	0714-CP7N		PTSKSWG084
P802	CONN WAFER	YW025-08 (STICK)		PTPWJBG116
P803	CONN WAFER	SMW200-14P		PTPWMSG116
P803B	CONNECTOR	20022HS-12S+20022HS-12S+ULW=800		PTCACAG141
P803B	CONNECTOR	20022HS-14S+SMH200-14P+ULW=300		PTCACAG151
P803C	CONNECTOR	20022HS-12S+20022HS-12S+ULW=300		PTCACAG141
P804	CONNECTOR	YH025-08+YBNH250-08+ULW=400		PTPWMSG116
P805	CONN WAFER	YW025-04 (STICK)		PTPWJBG116
P911C	CONNECTOR	12505HS-05+12505HS-05+ULW+CORE=600		PTUNSWG151
P911C	CONNECTOR	12505HS-05+12505HS-05+ULW+CORE=800		PTUNSWG141
PW1	CONN WAFER	12505WS-10A00		PTDGJ1G141
RC365	R CHIP	1/10 100 OHM J 1608		PTDGJ1G117
RC365	R CHIP	1/10 330 OHM J 1608		PTDGJ1G141
RC401	R CHIP	1/10 0 OHM J 1608		PTDGJ1G141
RC402	R CHIP	1/10 0 OHM J 1608		PTDGJ1G117
RC514	R CHIP	1/10 3.3K OHM J 1608		PTDGJ1G117
RC515	R CHIP	1/10 3.3K OHM J 1608		PTDGJ1G141

12. Circuit Diagram

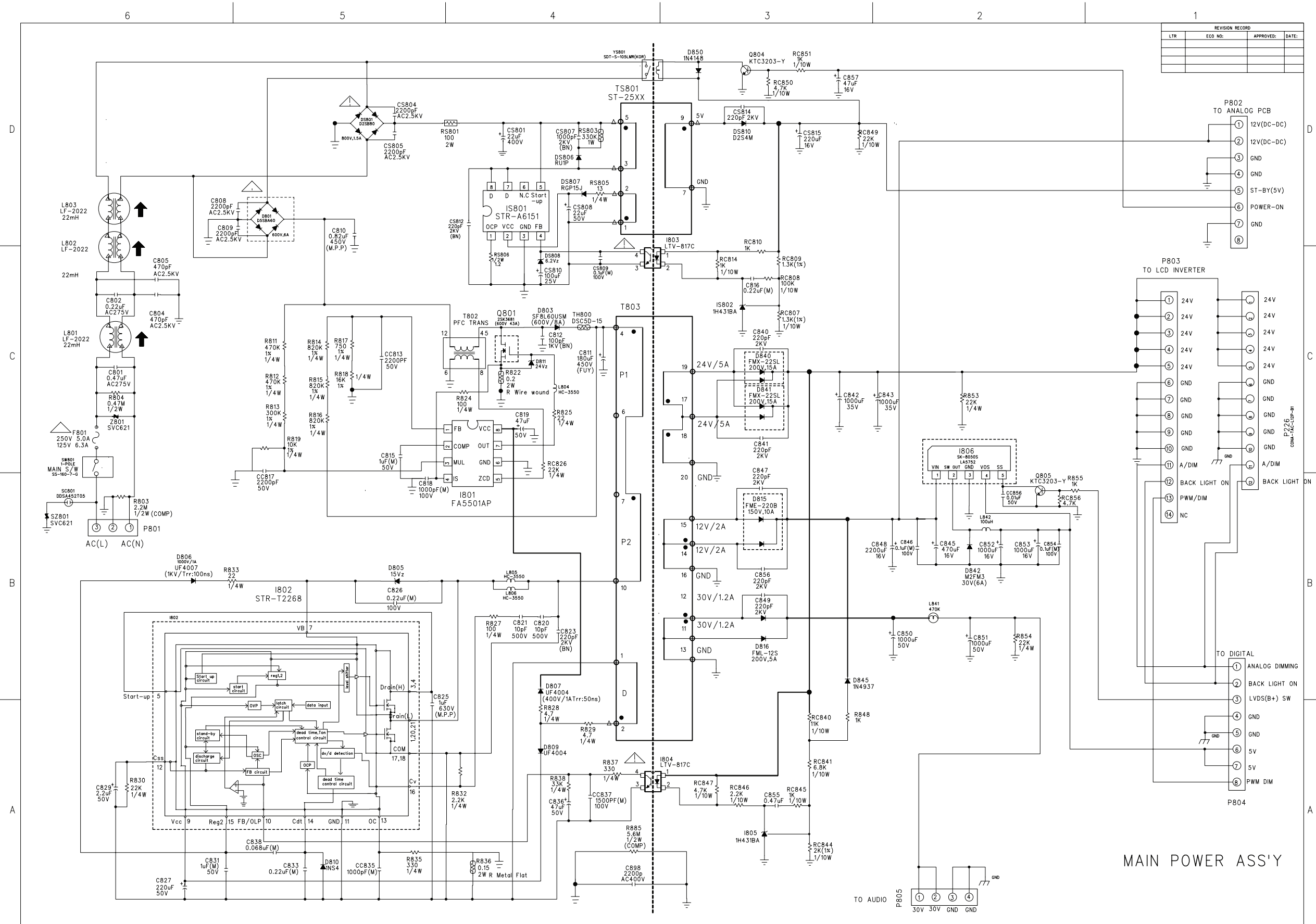

Circuit Diagram

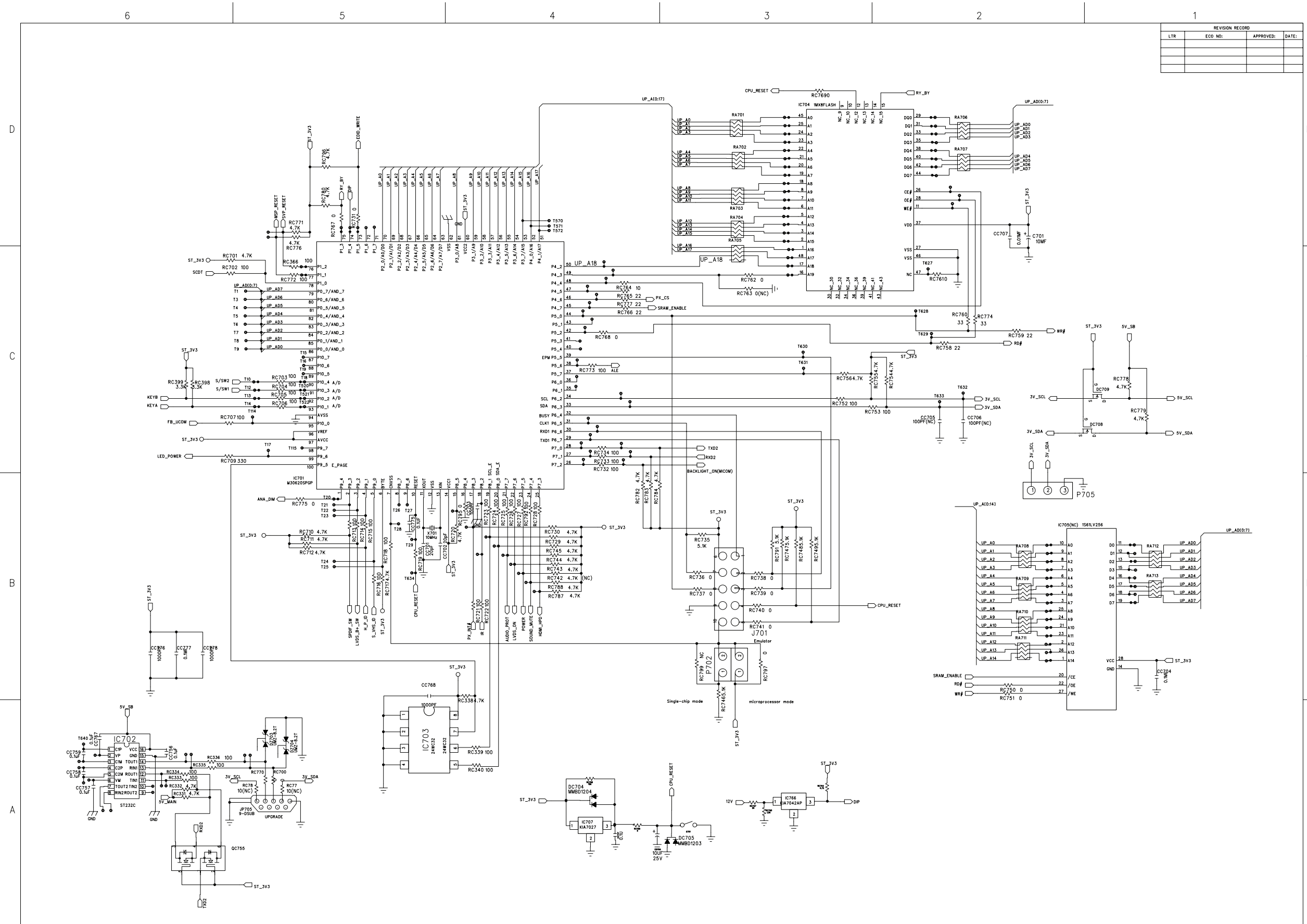

Circuit Diagram

6 5 4 3 2 1

REVISION RECORD			
LTR	ECO NO:	APPROVED:	DATE:

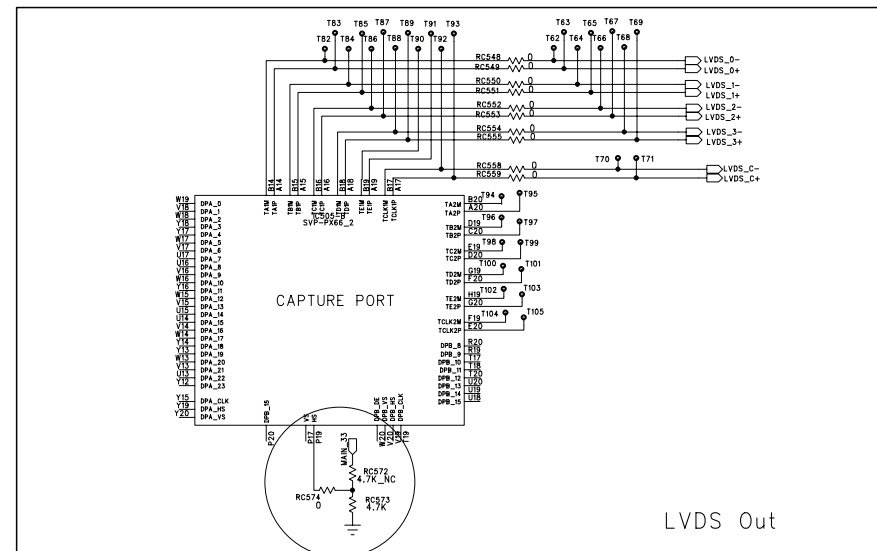
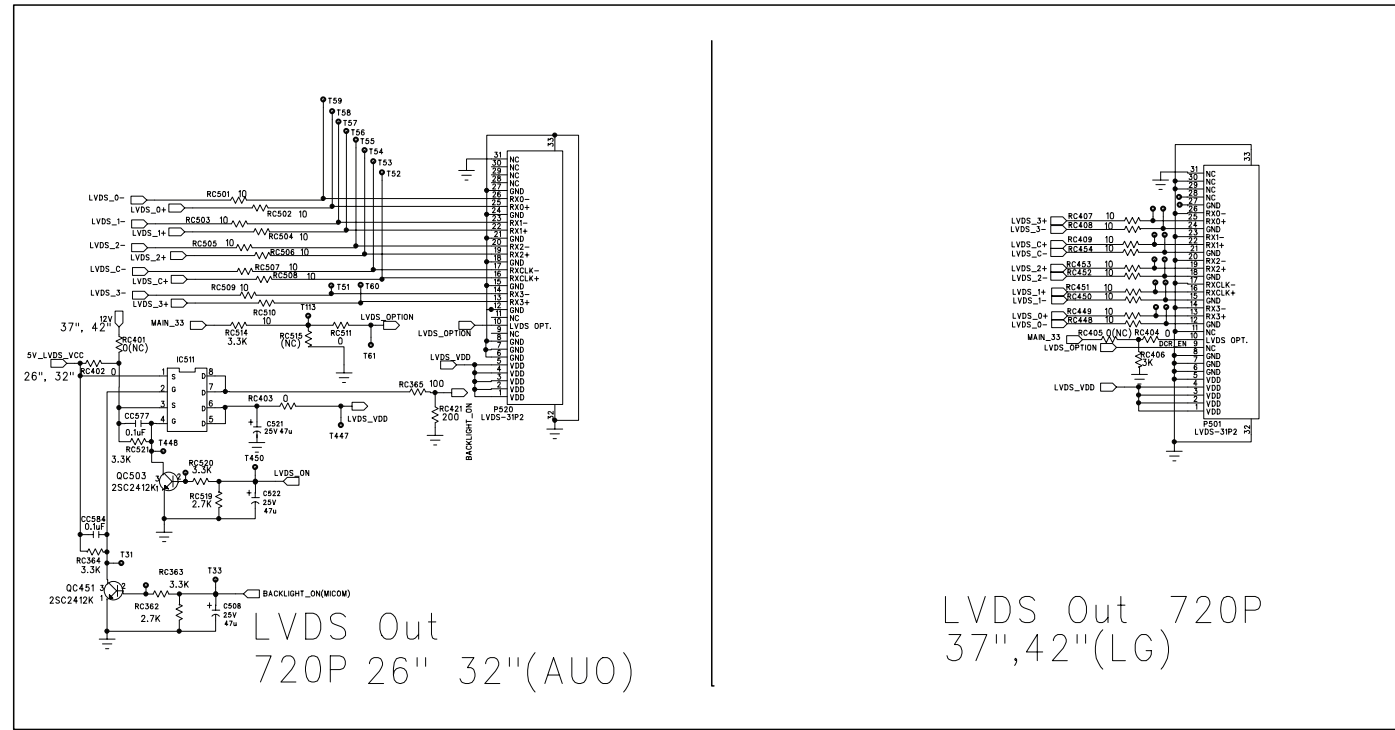

Circuit Diagram

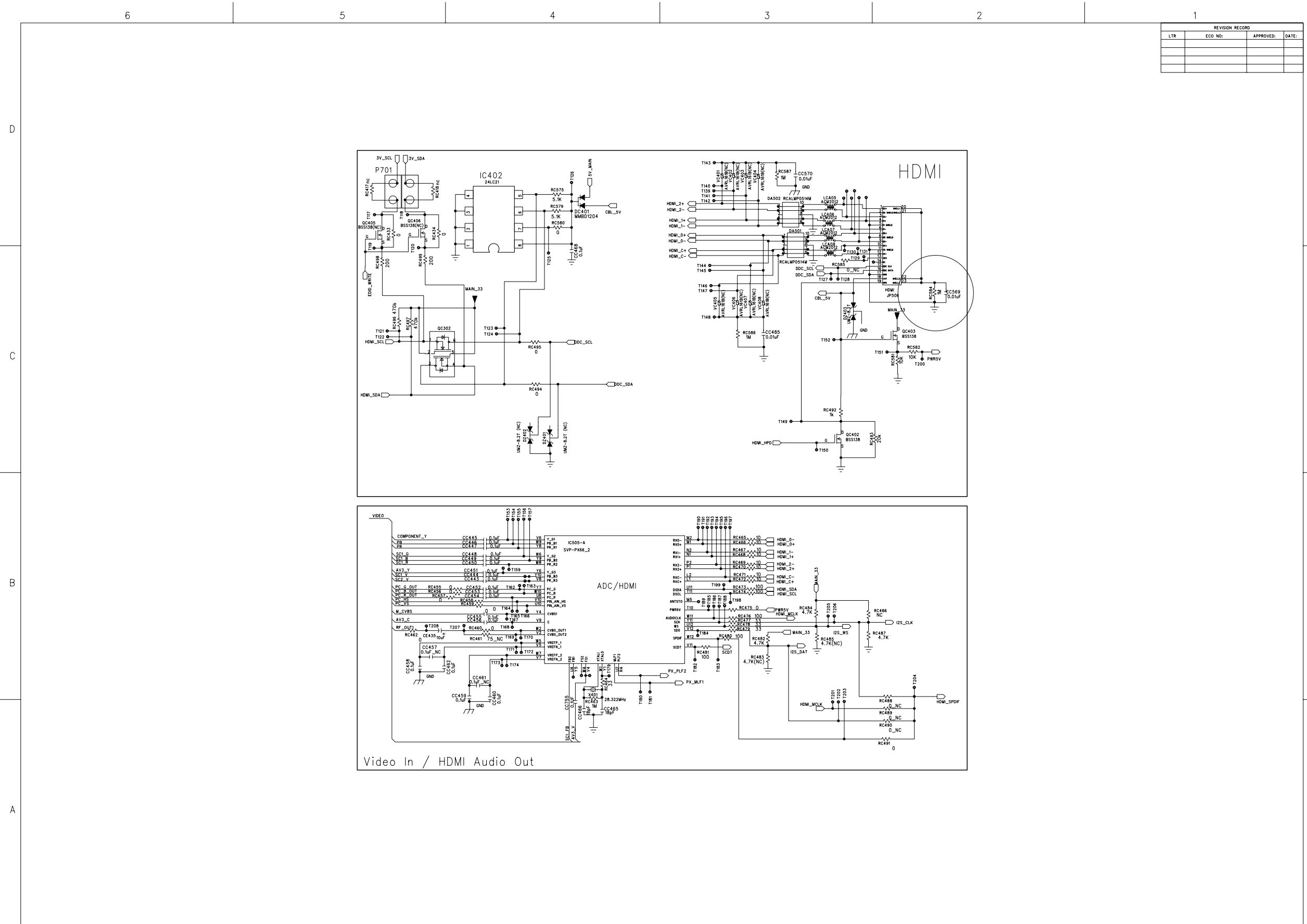

REVISION RECORD			
LTR	ECO NO:	APPROVED:	DATE:

Circuit Diagram

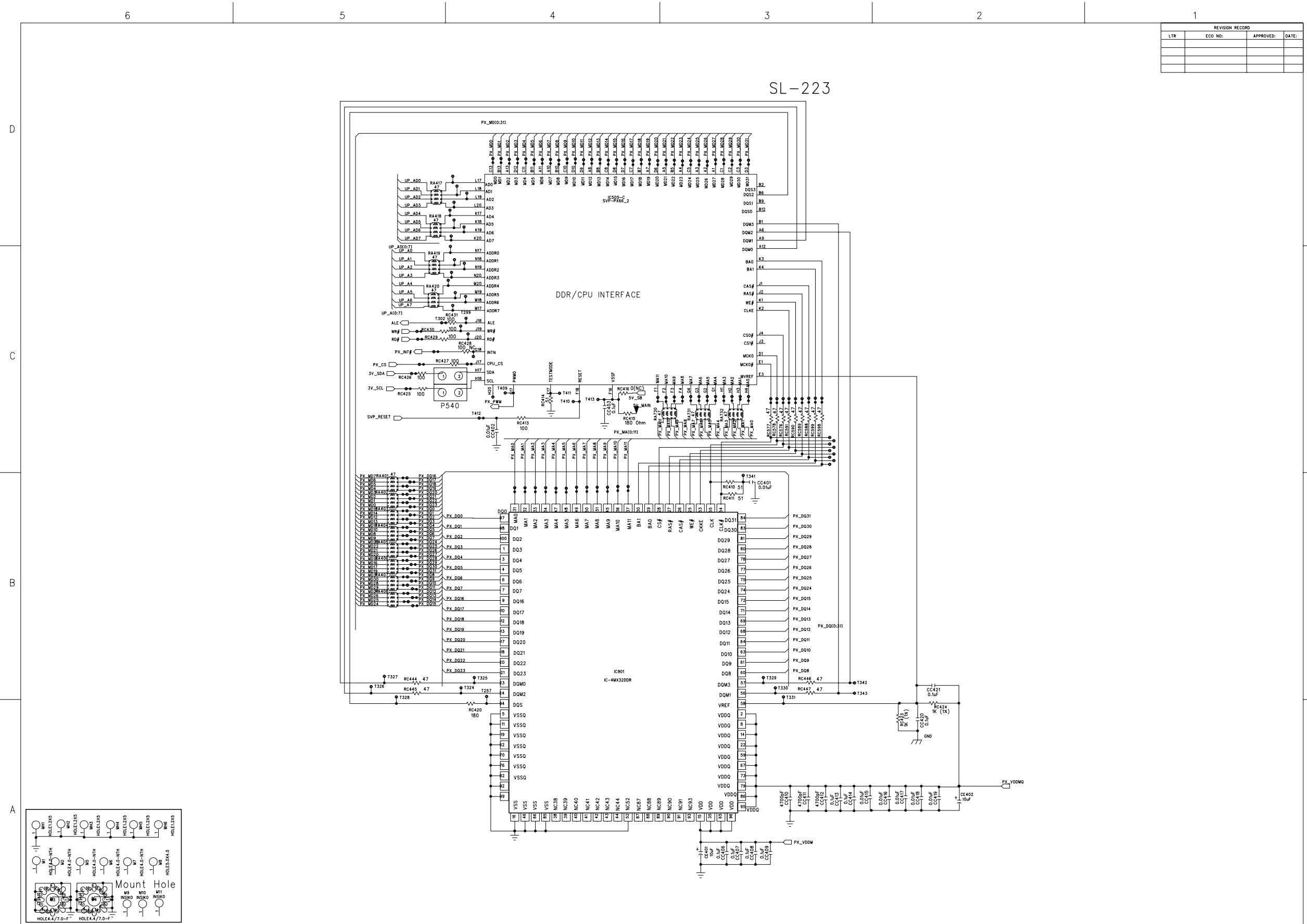

Circuit Diagram

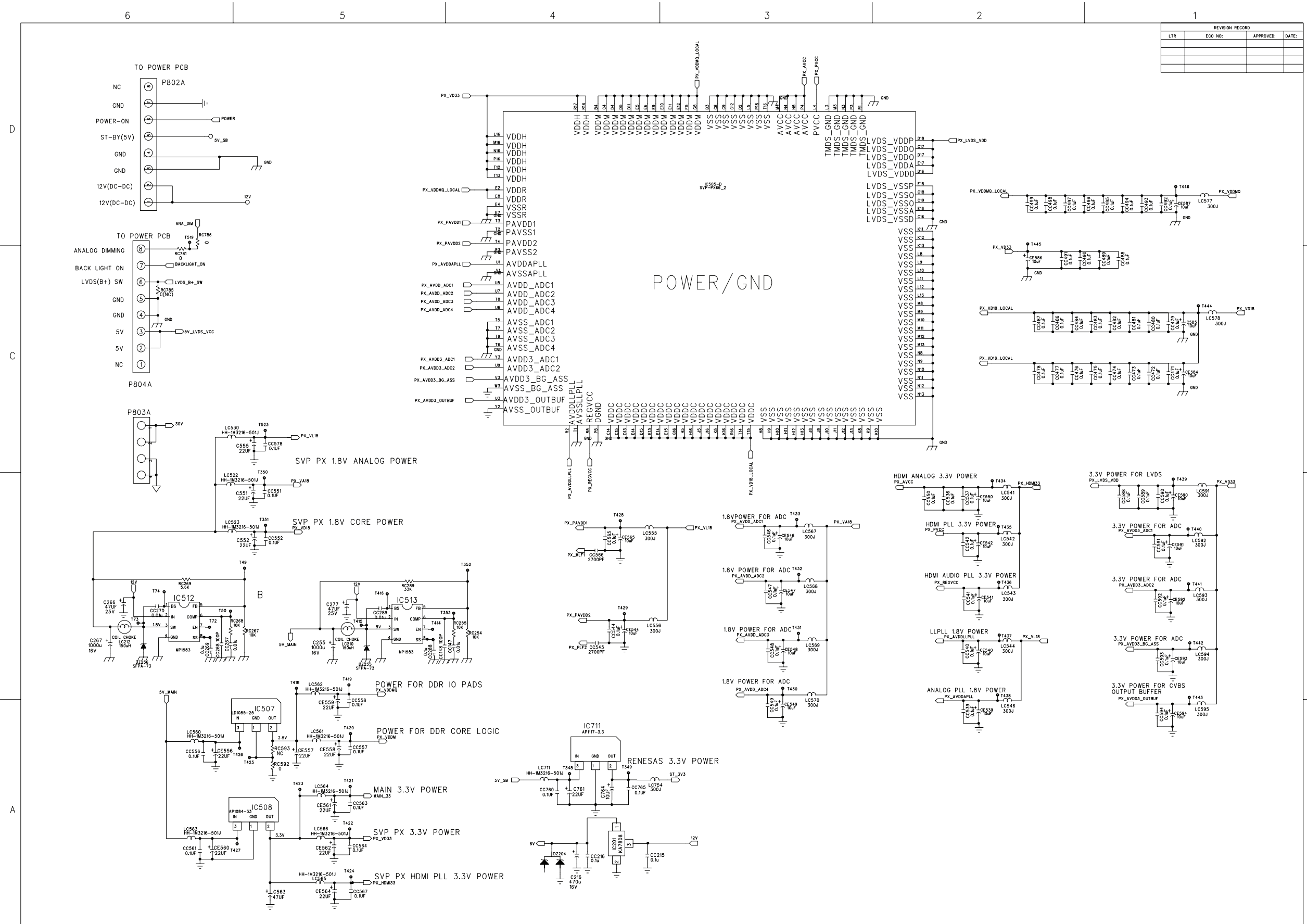

REVISION RECORD			
LTR	ECO NO:	APPROVED:	DATE:

Circuit Diagram

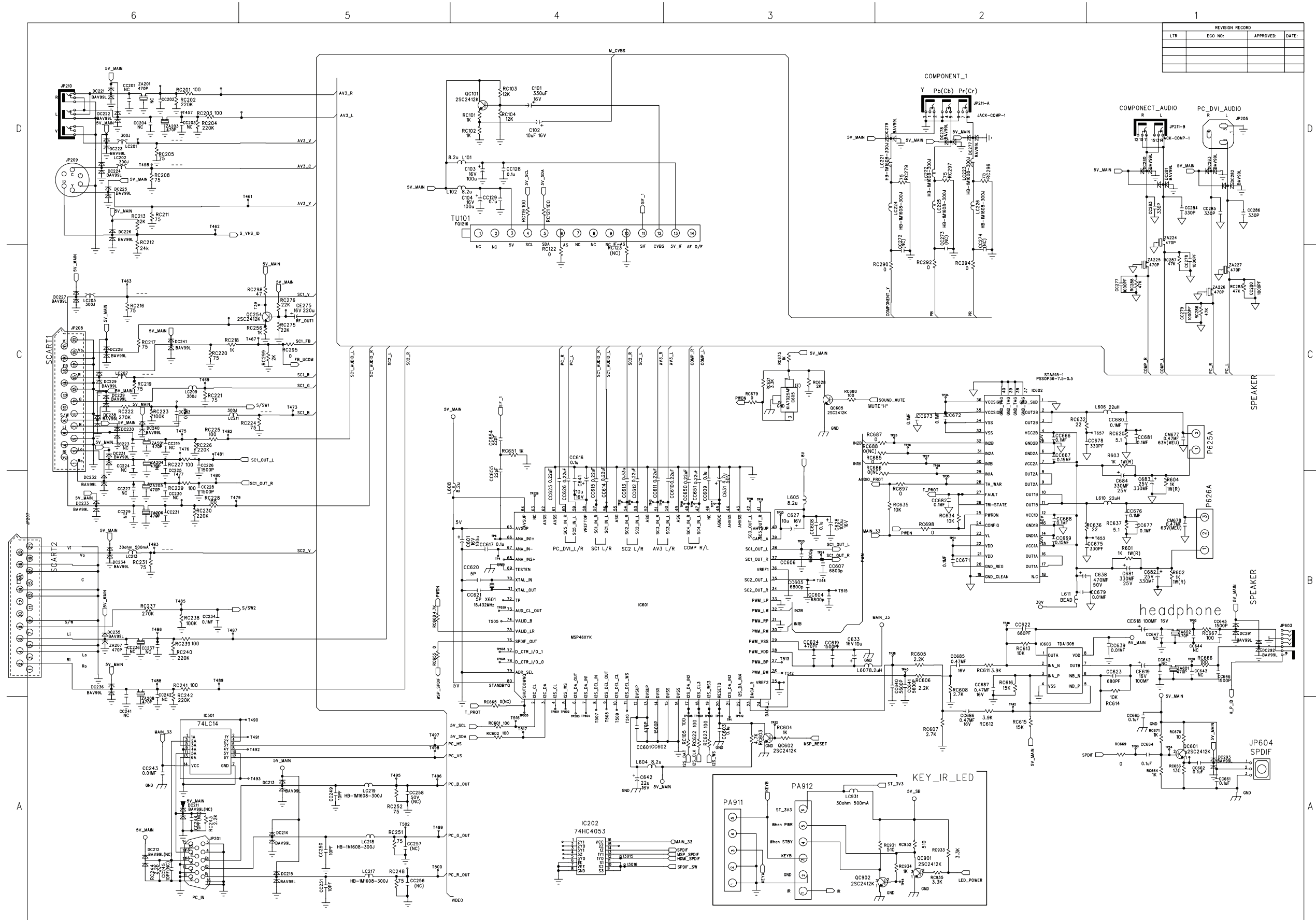



DAEWOO ELECTRONICS CORP.
686, AHYEON-DONG, MAPO-GU,
SEOUL, KOREA.
C.P.O. BOX 8003 SEOUL KOREA
PRINTED DATE : OCT. 2006