

DESCRIZIONE CODICE - CODE DESCRIPTION - DESCRIPTION DU CODE - BESCHREIBUNG VON KODE

213 = Frigorifero normale - Standard refrigerator - Refrigerateur normal - Normalkuhlschrank

214 = Frigorifero due porte - Two doors refrigerator - Refrigerateur deux portes - Zweittüriger

215 = Congelatore e NO FROST - Freezer and NO FROST - Congelateur et NO FROST - Gefrierschrank und NO FROST

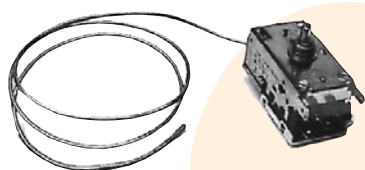

RANCO K59 - H1319

214 FR 31

AEG

Cod. orig. 671152133
Massimo - Cold: +3/-25,5°C
Minimo - Warm: +3/-14°C
Capillare: 700 mm

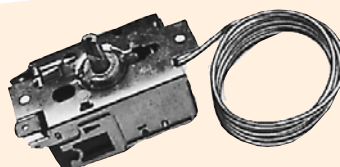

ATEA A01.0069

213 FR 18

ARISTON MERLONI

Cod. orig. 019212
Massimo - Cold: -23°C
Minimo - Warm: -9°C
Capillare: 700 mm

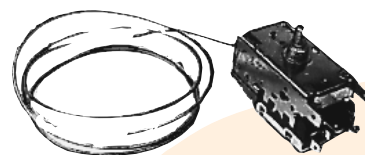

RANCO K59 - H1313

214 FR 33

AEG

Cod. orig. 671125467
Massimo - Cold: +3/-28°C
Minimo - Warm: +3/-17°C
Capillare: 900 mm

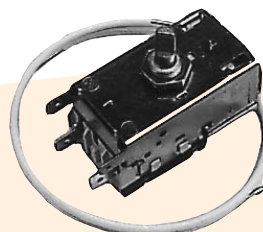

ATEA A01.0227

213 FR 19

ARISTON MERLONI

Cod. orig. 038704
Massimo - Cold: -23°C
Minimo - Warm: -12,5°C
Capillare: 700 mm

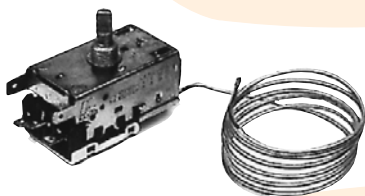

RANCO K59 - L1027

214 FR 43

AEG

Cod. orig. 671310500
Massimo - Cold: +5/-26°C
Minimo - Warm: +5/-15°C
Capillare: 800 mm

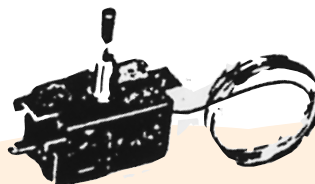

ATEA S2.0100

213 FR 20

ARISTON MERLONI

Cod. orig. 015246
Massimo - Cold: -23°C
Minimo - Warm: -12°C
Capillare: 650 mm



RANCO K59 - H1315

214 FR 44

AEG

Cod. orig. 671126931
Massimo - Cold: +5/-24°C
Minimo - Warm: +5/-16°C
Capillare: 900 mm



ATEA C19.01

214 FR 03

ARISTON MERLONI

Cod. orig. 006796
Massimo - Cold: +6/-23°C
Minimo - Warm: +6/-16°C
Capillare: 950 mm

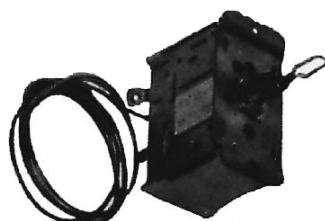

ATEA SA17.09

213 FR 04

ARISTON MERLONI

Cod. orig. 007032
Massimo - Cold: -20°C
Minimo - Warm: -9°C
Capillare: 750 mm

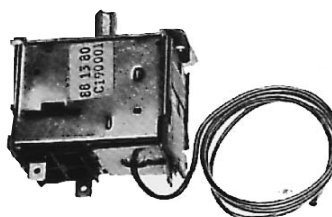

ATEA C19.0001

214 FR 04

ARISTON MERLONI

Cod. orig. 010114
Massimo - Cold: +4/-23°C
Minimo - Warm: +4/-15°C
Capillare: 550 mm



ATEA A03.0213

214 FR 16

ARISTON MERLONI

Cod. orig. 014007
Massimo - Cold: +3/-28°C
Minimo - Warm: +3/-13.5°C
Capillare: 600 mm

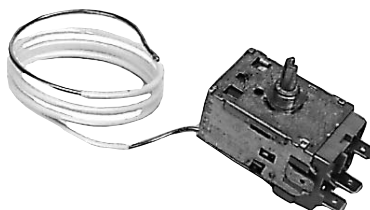

**RANCO K59 - L1203
ATEA A13.0172**

214 FR 47

ARISTON MERLONI

Cod. orig. 038640
Massimo - Cold: +4/-24°C
Minimo - Warm: +4/-13.5°C
Capillare: 700 mm

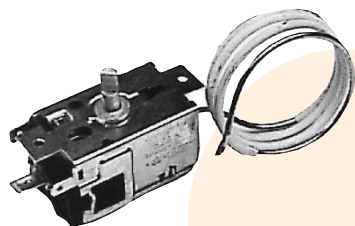

ATEA A03.0084

214 FR 27

ARISTON MERLONI

Cod. orig. 019880
Massimo - Cold: +3/-28°C
Minimo - Warm: +3/-13.5°C
Capillare: 600 mm

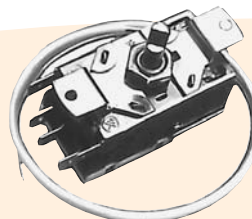

**RANCO K59 - L1048
ATEA A13.0107**

214 FR 75

ARISTON MERLONI

Cod. orig. 019882
Massimo - Cold: +3/-28°C
Minimo - Warm: +3/-13.5°C
Capillare: 600 mm

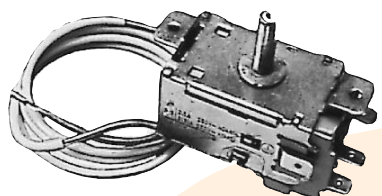

ATEA A13.0106

214 FR 34

ARISTON MERLONI

Cod. orig. 018756
Massimo - Cold: +4/-28°C
Minimo - Warm: +4/-15°C
Capillare: 700 mm

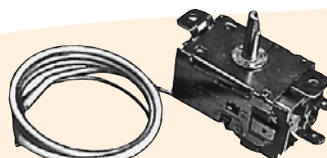

ATEA A13.0108

214 FR 76

ARISTON MERLONI

Cod. orig. 025396
Capillare: 700 mm

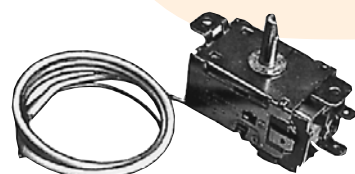

ATEA A03.0091

214 FR 38

ARISTON MERLONI

Cod. orig. 023289
Massimo - Cold: +3/-28°C
Minimo - Warm: +3/-13.5°C
Capillare: 750 mm

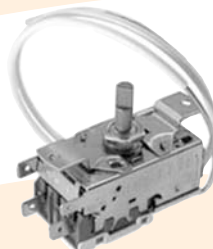

RANCO K59-L4033

214 FR 78

ARISTON MERLONI

Cod. orig. 019881
Massimo - Cold: -28.5 °C
Minimo - Warm: -15°C
Capillare: 650 mm

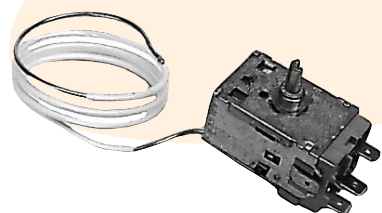

ATEA A13.0218

214 FR 45

ARISTON MERLONI

Cod. orig. 041082
Massimo - Cold: +3,5/-24°C
Minimo - Warm: +3,5/-8,5°C
Capillare: 1000 mm



RANCO K59 - H2811

214 FR 48

BAUKNECHT

Cod. orig. 01/360000000600
Massimo - Cold: +4,5/-30°C
Minimo - Warm: +4,5/-19°C
Capillare: 1200 mm

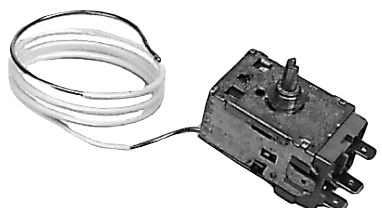

**RANCO K59 - L1204
ATEA A13.0175**

214 FR 46

ARISTON MERLONI

Cod. orig. 038650
Massimo - Cold: +3,5/-24°C
Minimo - Warm: +3,5/-8,5°C
Capillare: 700 mm

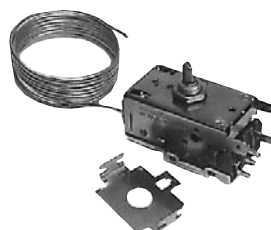

RANCO K59 - H2837

214 FR 21

**BOSCH
SIEMENS**

Cod. orig. 1707212232
Cod. orig. 072727-054179
Massimo - Cold: +4,2/-28,6°C
Minimo - Warm: +4,2/-18,7°C
Capillare: 1200 mm

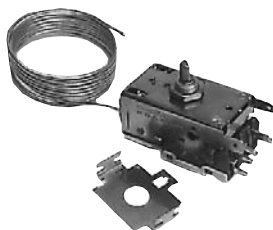

RANCO K59 - H1338

214 FR 49

**BOSCH
SIEMENS**

Cod. orig. 1707212233
Cod. orig. 073595/054184
Massimo - Cold: +4,2/-23,7°C
Minimo - Warm: +4,2/-11,8°C
Capillare: 750 mm



ATEA A03.0222

214 FR 73

BRANDT

Cod. orig. 41 x 7895
Massimo - Cold: +3/-22°C
Minimo - Warm: +3/-12,8°C
Capillare: 1200 mm

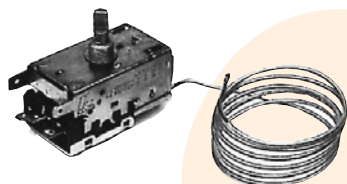

RANCO K59 - H1342

214 FR 77

**BOSCH
SIEMENS**

Massimo - Cold: +4,2/-30,6°C
Minimo - Warm: +4,2/-13,3°C
Capillare: 560 mm

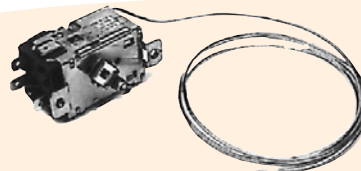

ATEA TB08C765

214 FR 11

**CANDY
KELVINATOR**

Massimo - Cold: +5/-26°C
Minimo - Warm: +5/-13,7°C
Capillare: 900 mm



**SELNEV TB.08B620
ATEA A13.0238**

214 FR 29

BRANDT

Cod. orig. 41 x 3980
Massimo - Cold: +4/-26°C
Minimo - Warm: +4/-13°C
Capillare: 1000 mm

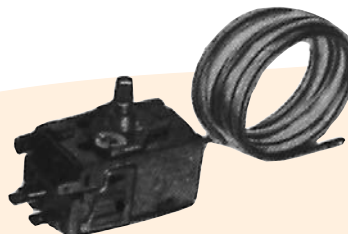

ATEA A13.0014

214 FR 17

**CANDY
KELVINATOR**

Cod. orig. 92242544
Massimo - Cold: +5/-27,5°C
Minimo - Warm: +5/-14°C
Capillare: 900 mm

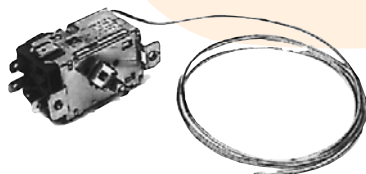

**SELNEV TB.08F639
ATEA A13.0246**

214 FR 50

BRANDT

Cod. orig. 41 x 7898
Massimo - Cold: +3/-22°C
Minimo - Warm: +3/-12,8°C
Capillare: 700 mm



RANCO K59-L1008

214 FR 53

**CANDY
KELVINATOR**

Massimo - Cold: +5/-26°C
Minimo - Warm: +5/-13°C
Capillare: 900 mm

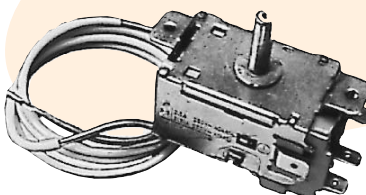

**SELNEV TB.08A808
ATEA A13.0068**

214 FR 51

BRANDT

Cod. orig. 41 x 9383
Massimo - Cold: +5/-17,8°C
Minimo - Warm: +5/-10°C
Capillare: 1300 mm

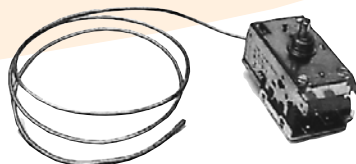

**RANCO K59-P1622
RANCO K59 - L1913**

214 FR 54

**CANDY
KELVINATOR**

Massimo - Cold: +5/-15°C
Minimo - Warm: +5/-8°C
Capillare: 600 mm

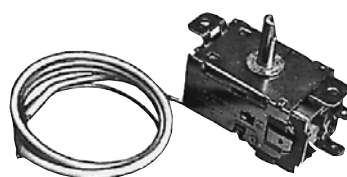

SELNEV TB.06A746 - TB06A798

214 FR 52

BRANDT

Cod. orig. 41 x 8119
Massimo - Cold: +5/-18°C
Minimo - Warm: +5/-6°C
Capillare: 1300 mm

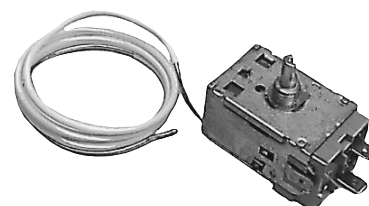

ATEA A03.0012

214 FR 55

**CANDY
KELVINATOR**

Massimo - Cold: +3/-25°C
Minimo - Warm: +3/-8°C
Capillare: 1200 mm

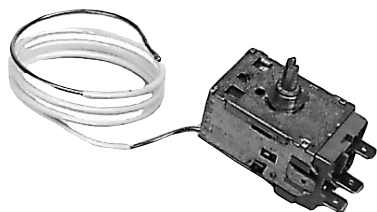

ATEA A13.0024

214 FR 56

**CANDY
KELVINATOR**

Massimo - Cold: +3/-28°C
Minimo - Warm: +3/-11°C
Capillare: 900 mm

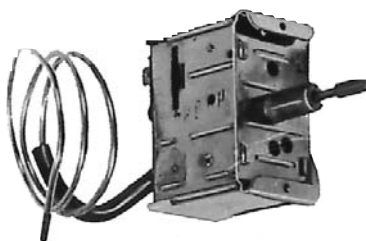

ATEA SA17

213 FR 02

**WHIRLPOOL
IGNIS
PHILIPS**

Cod. orig. 481927128264
Massimo - Cold: -21°C
Minimo - Warm: -10°C
Capillare: 550 mm

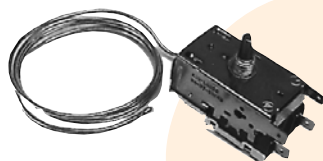

RANCO K59 - P4947

214 FR 70

**CANDY
KELVINATOR**

Massimo - Cold: +4/-32°C
Minimo - Warm: +4/-15°C
Capillare: 680 mm

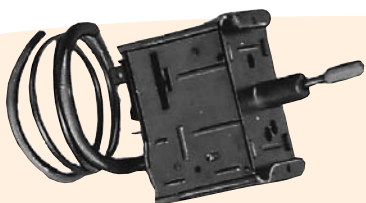

ATEA SA18

213 FR 03

**WHIRLPOOL
IGNIS
PHILIPS**

Cod. orig. 481927128265
Massimo - Cold: -18°C
Minimo - Warm: -8°C
Capillare: 550 mm



ATEA S2.0115

213 FR 16

IBERNA

Massimo - Cold: -27°C
Minimo - Warm: -13°C
Capillare: 1200 mm



RANCO K60-L2097
ATEA S2.0218

213 FR 14

**WHIRLPOOL
IGNIS
PHILIPS**

Cod. orig. 481927128614
Massimo - Cold: -21°C
Minimo - Warm: -10°C
Capillare: 1300 mm

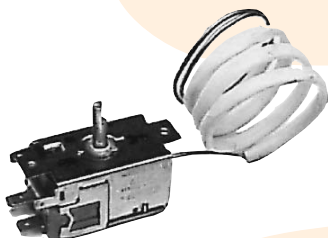

ATEA A13.0027

214 FR 25

IBERNA

Massimo - Cold: +4/-25°C
Minimo - Warm: +4/-15°C
Capillare: 800 mm

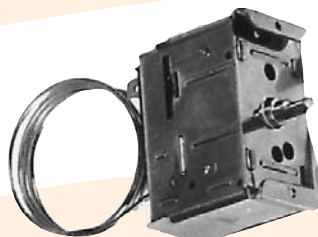

ATEA C19

214 FR 00

**WHIRLPOOL
IGNIS
PHILIPS**

Cod. orig. 481927128094
Massimo - Cold: +4,5/-22°C
Minimo - Warm: +4,5/-11°C
Capillare: 900 mm

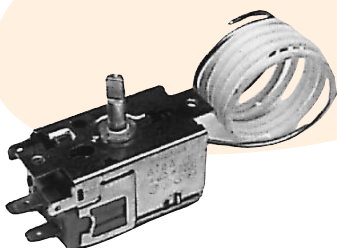

ATEA A13.0021

214 FR 26

IBERNA

Massimo - Cold: +4/-25°C
Minimo - Warm: +4/-10°C
Capillare: 800 mm

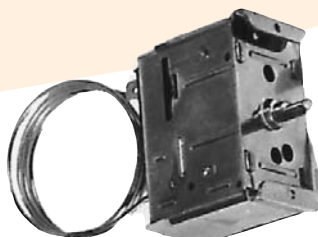

ATEA C28

214 FR 02

**WHIRLPOOL
IGNIS
PHILIPS**

Cod. orig. 481927128135
Massimo - Cold: +4,5/-22°C
Minimo - Warm: +4,5/-11°C
Capillare: 900 mm

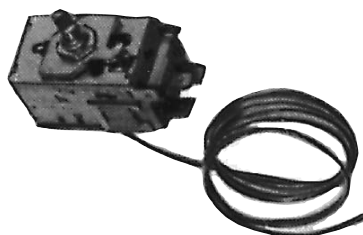

ATEA A04.0029

215 FR 11

IBERNA

Massimo - Cold: -28°C
Minimo - Warm: -16°C
Capillare: 900 mm

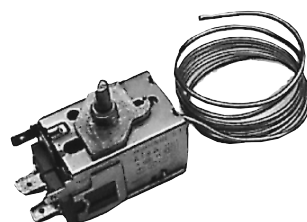



ATEA A13.0058

214 FR 35

**WHIRLPOOL
IGNIS
PHILIPS**

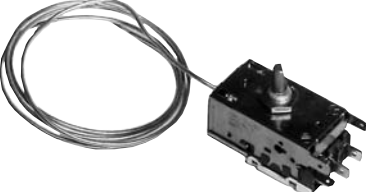
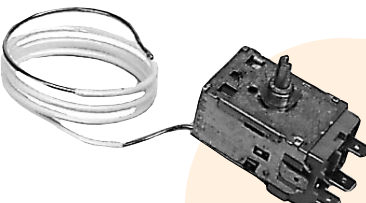
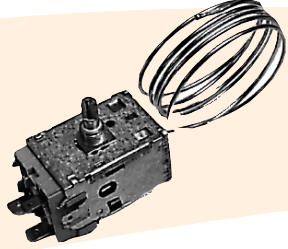
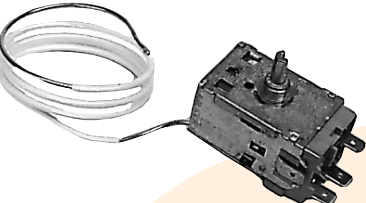
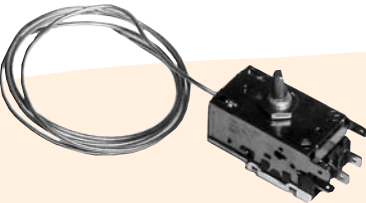
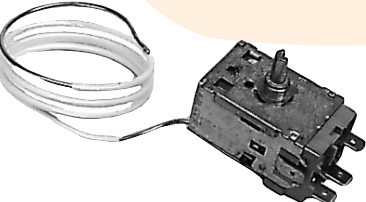
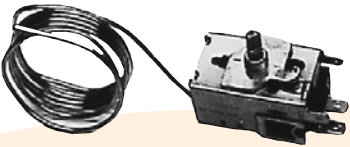
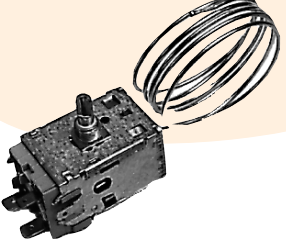
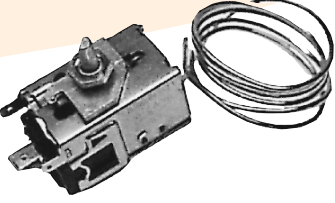
Cod. orig. 481931023701
Massimo - Cold: +4,5/-24°C
Minimo - Warm: +4,5/-11°C
Capillare: 1000 mm

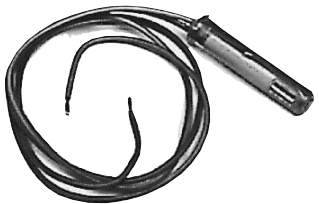
 <p>ATEA A13.0059</p>	<p>214 FR 37</p> <p>WHIRLPOOL IGNIS PHILIPS</p> <p>Cod. orig. 481927128787 Massimo - Cold: +4,5/-17°C Minimo - Warm: +4,5/-6°C Capillare: 1700 mm</p>	 <p>RANCO K59 - L1130</p>	<p>214 FR 69</p> <p>WHIRLPOOL IGNIS PHILIPS</p> <p>Cod. orig. 481927128671 Massimo - Cold: +4,5/-26°C Minimo - Warm: +4,5/-13°C Capillare: 1000 mm</p>
 <p>ATEA A13.0060</p>	<p>214 FR 57</p> <p>WHIRLPOOL IGNIS PHILIPS</p> <p>Cod. orig. 481927128778 Massimo - Cold: +4,5/-30°C Minimo - Warm: +4,5/-16°C Capillare: 1000 mm</p>	 <p>ATEA A13.0072/A13.0063</p>	<p>214 FR 71</p> <p>WHIRLPOOL PHILIPS - IGNIS</p> <p>Cod. orig. 481927128854 Ex cod. 481927128605 Massimo - Cold: +4,5/-26°C Minimo - Warm: +4,5/-13°C Capillare: 1200 mm</p>
 <p>ATEA A13.0057</p>	<p>214 FR 58</p> <p>WHIRLPOOL IGNIS PHILIPS</p> <p>Cod. orig. 481927128783 Massimo - Cold: +4,5/-26°C Minimo - Warm: +4,5/-13°C Capillare: 1000 mm</p>	 <p>RANCO K59 - L1129</p>	<p>214 FR 74</p> <p>WHIRLPOOL PHILIPS IGNIS</p> <p>Cod. orig. 481927128669 Massimo - Cold: +4,5/-30°C Minimo - Warm: +4,5/-16°C Capillare: 1000 mm</p>
 <p>ATEA A13.0071</p>	<p>214 FR 59</p> <p>WHIRLPOOL IGNIS PHILIPS</p> <p>Cod. orig. 5481927128672</p>	 <p>ATEA A01.0047</p>	<p>215 FR 12</p> <p>IGNIS PHILIPS BAUKNECHT WHIRLPOOL</p> <p>Cod. orig. 481927128606 NO FRÖST</p>
 <p>ATEA A13.0063</p>	<p>214 FR 68</p> <p>WHIRLPOOL IGNIS PHILIPS</p> <p>Cod. orig. 481927128854 Massimo - Cold: +4,5/-30°C Minimo - Warm: +4,5/-16°C Capillare: 1000 mm</p>	 <p>ATEA A01.0037</p>	<p>215 FR 13</p> <p>IGNIS PHILIPS BAUKNECHT WHIRLPOOL</p> <p>Cod. orig. 481927128644 NO FRÖST</p>
 <p>RANCO K59 - L4020</p>	<p>214 FR 60</p> <p>WHIRLPOOL IGNIS PHILIPS</p> <p>Cod. orig. 481927128414 Massimo - Cold: -30°C Minimo - Warm: -16°C Capillare: 1000 mm</p>		<p>215 FR 14</p> <p>IGNIS PHILIPS BAUKNECHT</p> <p>Cod. orig. 481925228071 NO FRÖST</p>



215 FR 15

**WHIRLPOOL
PHILIPS
IGNIS**

Cod. orig. 481928228481
Termoregolatore
NO FROST

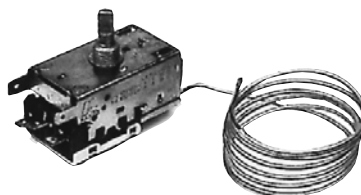

214 FR 32

**LIEBHERR
MIELE**

Massimo - Cold: +5/-31°C
Minimo - Warm: +5/-19°C
Capillare: 900 mm

RANCO K59 - H2800

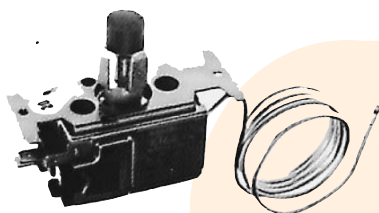

213 FR 13

INDESIT

Cod. orig. 028811
Massimo - -24°C
Minimo - Warm: -10°C
Capillare: 600 mm

ATEA S2.0156

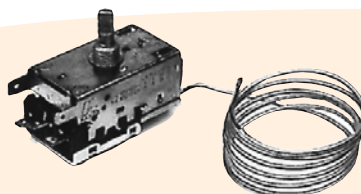

214 FR 62

LIEBHERR

Massimo - Cold: +5/-25°C
Minimo - Warm: +5/-10°C
Capillare: 900 mm

RANCO K59 - H2816

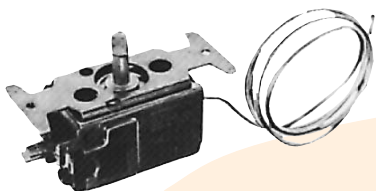

214 FR 13

INDESIT

Massimo - Cold: +5/-25°C
Minimo - Warm: +5/-16°C
Capillare: 750 mm

ATEA A03.0133

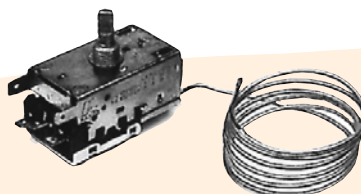

214 FR 63

LIEBHERR

Massimo - Cold: -35°C
Minimo - Warm: +22°C
Capillare: 1200 mm

RANCO K54 - H1101

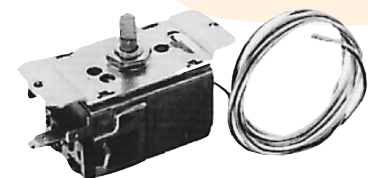

214 FR 14

INDESIT

Cod. orig. 105024
Massimo - Cold: +5/-25°C
Minimo - Warm: +5/-16°C
Capillare: 950 mm

ATEA A03.0054

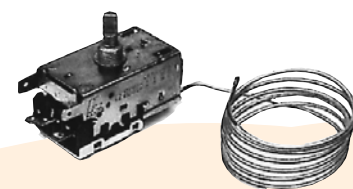

215 FR 16

LIEBHERR

Massimo - Cold: -36°C
Minimo - Warm: +22°C
Capillare: 2500 mm

RANCO K54 - H1119

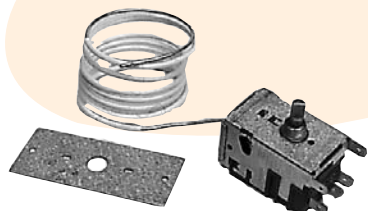

214 FR 61

INDESIT

Massimo - Cold: +4,5/-30°C
Minimo - Warm: +4,5/-11°C
Capillare: 1000 mm

DANFOSS 077B6053



215 FR 17

LIEBHERR

Massimo - Cold: -33°C
Minimo - Warm: +22°C
Capillare: 1200 mm

RANCO K59 - H2027

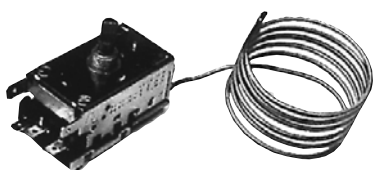

214 FR 30

**LIEBHERR
MIELE**

Massimo - Cold: +5/-19°C
Minimo - Warm: +5/-7°C
Capillare: 900 mm

RANCO K59 - H1300

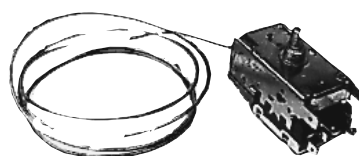

214 FR 64

LIEBHERR

Massimo - Cold: -22°C
Minimo - Warm: -3°C
Capillare: 900 mm

RANCO K57 - H5521



RANCO K50 - P6073

214 FR 65

LIEBHERR

Massimo - Cold: -13,5°C
Minimo - Warm: 0°C
Capillare: 1000 mm



ATEA C3.0115

214 FR 19

SILTAL

Massimo - Cold: +5/-27°C
Minimo - Warm: +5/-15°C
Capillare: 750 mm



**SELNEV T4 CE101
ATEA TB04.A882**

213 FR 11

MAGIC CHEF

Massimo - Cold: -18,5°C
Minimo - Warm: -9°C
Capillare: 600 mm

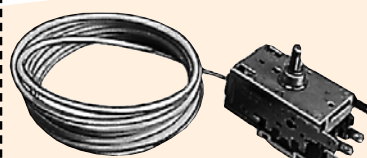

RANCO K59 - P1652

214 FR 42

**UNIVERSALE
2 PORTE - 2 DOORS**

Massimo - Cold: +5/-26°C
Minimo - Warm: +5/-11°C
Capillare: 2000 mm

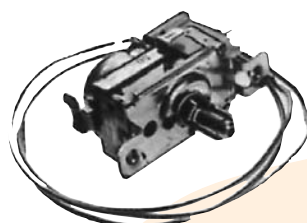

**SELNEV T6 EW155
ATEA TB 06.A727**

214 FR 24

MAGIC CHEF

Massimo - Cold: +5,5/-22°C
Minimo - Warm: +5,5/-12,8°C
Capillare: 800 mm

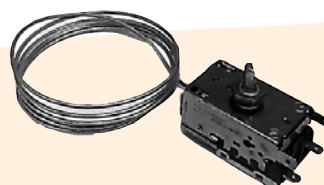

RANCO K50 - L6540

214 FR 72

VARI USI

Massimo - Cold { -24° out
+1° in
Minimo - Warm +8° in
Capillare: 1300 mm

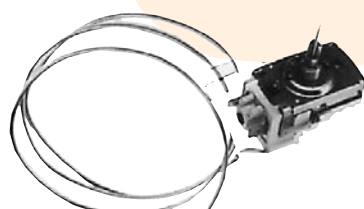

**SELNEV TB04.A839
ATEA S2.0262**

213 FR 10

PHILCO

Massimo - Cold: -24°C
Minimo - Warm: -3,7°C
Capillare: 800 mm



**RANCO K60 - L2008
RANCO K60 - L2120**

213 FR 05

**ELECTROLUX
ZANUSSI - REX**

Cod. orig. 2262184035
Cod. orig. 2262184019
Massimo - Cold: -25°C
Minimo - Warm: -1°C
Capillare: 800 mm

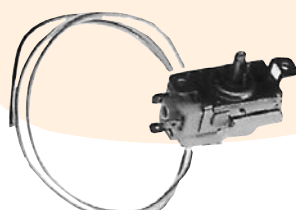

**SELNEV TB08.A634
ATEA A13.0286**

214 FR 10

PHILCO

Massimo - Cold: +3/-28°C
Minimo - Warm: +3/-19°C
Capillare: 800 mm

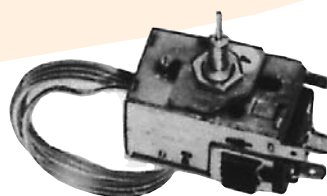

ATEA S2.003

213 FR 15

**ELECTROLUX
ZANUSSI - REX**

Cod. orig. 2262184035
Cod. orig. 50084319008
Massimo - Cold: -28°C
Minimo - Warm: -8°C
Capillare: 800 mm



RANCO K61 - H1010

214 FR 39

PHILCO

Massimo - Cold: +4,5/-24°C
Minimo - Warm: +4,5/-14°C
Capillare: 580 mm

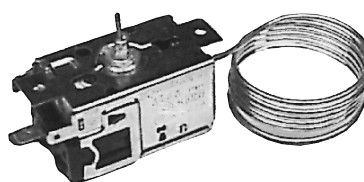

ATEA S2.0154

213 FR 17

**ELECTROLUX
ZANUSSI
REX**

Massimo - Cold: -17°C
Minimo - Warm: -7,5°C
Capillare: 850 mm

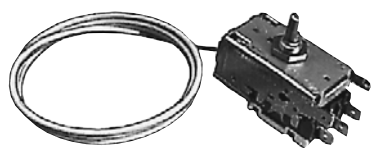

**RANCO K59 - L1035
RANCO K59 - L1265**

214 FR 06

**ELECTROLUX
ZANUSSI - REX**

Cod. orig. 50087512005
Cod. orig. 2262143023
Massimo - Cold: +5/-26°C
Minimo - Warm: +5/-15°C
Capillare: 1000 mm



RANCO K61 - L2505

215 FR 19

**ELECTROLUX
ZANUSSI
REX**

Massimo - Cold: -26,9°C
Minimo - Warm: -14,3°C
Capillare: 1000 mm

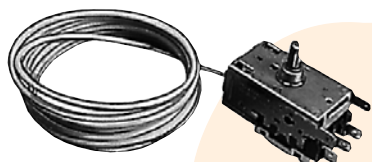

RANCO K59 - L1119

214 FR 40

**ELECTROLUX
ZANUSSI
REX**

Cod. orig. 50116858007
Massimo - Cold: +5/-32°C
Minimo - Warm: +5/-12°C
Capillare: 2250 mm

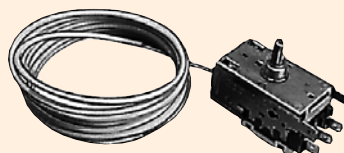

RANCO K57 - P2068

215 FR 20

**ELECTROLUX
ZANUSSI
REX**



**RANCO K59 - L1117
RANCO K59 - L1260**

214 FR 41

**ELECTROLUX
ZANUSSI
REX**

Cod. orig. 2262154038
Massimo - Cold: +5/-32°C
Minimo - Warm: +5/-12°C
Capillare: 1000 mm

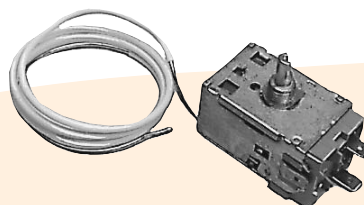

ATEA A03.0014

214 FR 15

**ZEROWATT
CANDY
KELVINATOR**

Massimo - Cold: +3/-25,5°C
Minimo - Warm: +3/-15,5°C
Capillare: 1000 mm

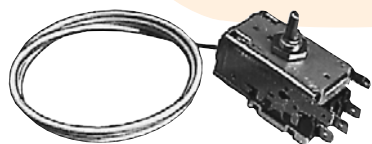

RANCO K59 - L1096

214 FR 66

**ELECTROLUX
ZANUSSI
REX**

Cod. orig. 50215927000
Massimo - Cold: +5/-26°C
Minimo - Warm: +5/-7°C
Capillare: 1000 mm

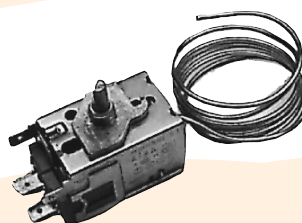

ATEA A13.0015

214 FR 28

**ZEROWATT
CANDY
KELVINATOR**

Massimo - Cold: +3/-25,5°C
Minimo - Warm: +3/-15°C
Capillare: 1000 mm

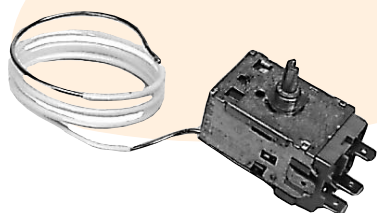

ATEA A013.0056

214 FR 67

**ELECTROLUX
ZANUSSI
REX**

Massimo - Cold: +5/-26°C
Minimo - Warm: +5/-15,5°C
Capillare: 1000 mm

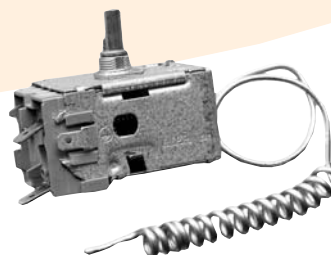

ATEA A01.0183

215 FR 21

**TERMOSTATO
NO FROST
VARIE CASE
WHIRLPOOL**

Massimo - Cold: -30°C
Minimo - Warm: -19°C
Capillare: 225 mm



RANCO K54 - L1825

215 FR 18

**ELECTROLUX
ZANUSSI
REX**

Cod. orig. 50059677000
Massimo - Cold: -34°C
Minimo - Warm: -13°C
Capillare: 1500 mm

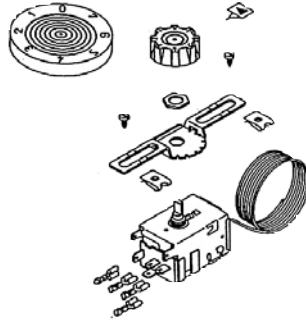

CODICE CODE CODE KODE	ARTICOLO ARTICLE ITEM ARTIKEL	APPLICAZIONE APPLICATION UTILIZATION	WARM IN/OUT °C	COLD IN/OUT °C	DEFROST	SIGNAL OPERATION	CAPILLARE CAPILLAIRE CAPILLARY KAPILLARE	NOTE REMARQUES REMARKS BEMERKUNGEN
216 FR 00	077B7001 090B0811.08	Frigorifero normale Réfrigérateur normal Standard refrigerator Normalkühlshrank	+2 / -5,5	-13,5 / -25			mm 1200	1
216 FR 01	077B7002 090B4029.08	Frigorifero con sbrinatorio semiautomatico Réfrigérateur avec dégivrage Sèmi-automatique Refrigerator with semi - automatic defroster Kühlshrank mit halbautomatischer Abtauvorrichtung	0 / -7,5	-11 / -21	+6		mm 1000	2
216 FR 02	077B7003 090B6251.08	Frigorifero 2 porte Réfrigérateur 2 porte 2 door refrigerator Zweittüriger Kühlshrank	+3,5 / -11	+3,5 / -27,5			mm 1200	3
216 FR 03	077B7006 090B1050.08	Congelatore con allarme Congélateur avec alarm Freezer with alarm Gefrierschrank mit alarm	-10 / -17	-24 / -34,5			mm 1800	6



VaRifix
THERMOSTATE

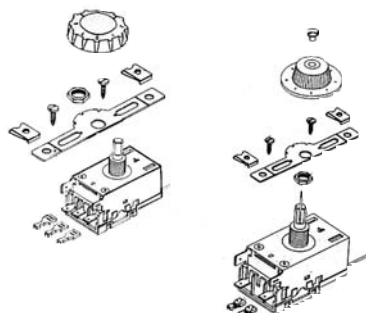

CODICE CODE CODE KODE	ARTICOLO ARTICLE ITEM ARTIKEL	APPLICAZIONE APPLICATION UTILIZATION	POSIZIONE MANOPOLA - POSITION BOUTON KNOB POSITION - KNOPFSTELLUNG						CAPILLARE CAPILLAIRE CAPILLARY KAPILLARE
			7 COLD OUT	4 NORMAL OUT IN		1 WARM OUT IN		DEFROST IN	
216 FR 04	VC 1 K 50 - P1110	Frigorifero a compressore Réfrigérateur à compresseur Compressor refrigerator Kuhlschrank	-23	-14,5	-5	-5	+2		mm 1200
216 FR 05	VP 4 K 60 - 1013	Frigorifero con sbrinamento a pulsante Réfrigérateur avec degivrage à bouton Push button defrost Kuhlschrank abtau druckknopf	-25			-10,4	-1	+5,5	mm 1200
216 FR 06	VT 9 K 59 - L1102	Frigoriferi a due porte Réfrigérateur deux températures Two temperature refrigerator Zwei temperature Kuhlschrank	-26			-11		+3,5	mm 1200
216 FR 07	VS 5 K 50 - P1102	Freezer con segnale d'allarme standard Congelateur avec alarm Freezer with alarm Gefrierschrank signal	-34	-24	-16,5		-12		mm 2000
216 FR 13	VB 7 K 50 - P1118	aRefrigeratori di bottiglie Réfrigérateur de bouteilles Water, drinks and bottles refrigerators Flaschen Kauhler	-3	+2	+6,5		+12,5		mm 1200
216 FR 16	VF 3 K 50 - P1117	Freezer Congelateur Freezer Gefrierschrank	-34	-24	-16		-12		mm 2000
216 FR 20	VR 6 K 54 - P3100	Freezer con allarme invertito Congelateur signal inverse Freezer renvers signal Gefrierschrank signal passiv	-32			-20	-15		mm 2000
216 FR 25	VA 2 K 50 - P1174	Frigoriferi ad assorbimento Réfrigérateur a absorption Absorber refrigerator Absorber Kuhlschrank	-18	-7	-5		+3,5		mm 2000
216 FR 33	VT 93 K59 - P1662	Frigoriferi a due porte Réfrigérateur deux températures Two temperature refrigerator Zwei temperature Kuhlschrank	-26			-11			mm 3000



VaRifix
THERMOSTATE

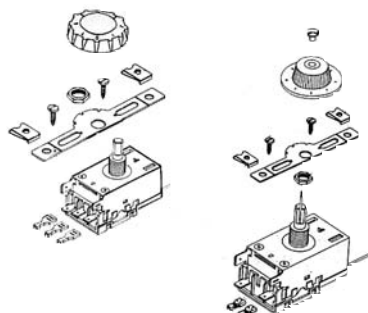

CODICE CODE CODE KODE	ARTICOLO ARTICLE ITEM ARTIKEL	APPLICAZIONE APPLICATION UTILIZATION	POSIZIONE MANOPOLA - POSITION BOUTON KNOB POSITION - KNOPFSTELLUNG							CAPILLARE CAPILLAIRE CAPILLARY KAPILLARE
			7 COLD OUT	4 NORMAL OUT	IN	1 WARM OUT	IN	DEFROST IN	COSTANT IN	
216 FR 15	VI 109 K 59 - H1303	Frigorifero a compressore Réfrigérateur à compresseur Compressor refrigerator Kuhlschrank 2 P	-21	-14		-6,5			+4,5	mm 2000
216 FR 14	VI 112 K 59 - H2805	Frigorifero a compressore Réfrigérateur à compresseur Compressor refrigerator Kuhlschrank 2 P	-28	-18		-11			+5	mm 1500
216 FR 21	VC 101 K 50 - H1104	Frigorifero a compressore Réfrigérateur à compresseur Compressor refrigerator Kuhlschrank 1 P	-22,5	-12,5	-4,5	-5	+2			mm 1200
216 FR 22	VF 103 K 50 - H1106	Freezer Conservator Freezer Gefrieremobil	-32	-23,5	-18	-16,5	-12			Amm 2000
216 FR 23	VP 104 K 60 - L2024	Frigorifero con sbrinamento a pulsante Réfrigérateur avec degivrage à bouton Push button defrost Kuhlschrank abtau druckknopf	-22	-15	-3		-1	+7,5		mm 1600
216 FR 24	VS 105 K 54 - H1404	Freezer con segnale d'allarme standard Congelateur signal normal Freezer standard signal Gefrierschrank aktiv signal	-34	-24	-18,5	-16,5	-12			mm 2000
216 FR 26	VC 110 K 50 - H1108	Raffreddatori bibite Réfrigérateurs pour boissons Drink and bottles refrigerators Getrankekuhlschrank	-12	-7	±0	-2,5	+4			mm 2000
216 FR 27	VB 107 K 50 - H1107	Raffreddatori acqua Réfrigérateurs d'eau Water drink refrigerator Wasserküler	-3	+3	+7,5	+8,5	+12,5			mm 2000
216 FR 28	VA 102 K 50 - H1105	Frigorifero ad assorbimento Réfrigérateur a absorption Absorber refrigerator Absorber Kuhlschrank	-18	-7	-4,5	+1,5	+3,5			mm 1200
216 FR 29	VP 111 K 60 - L2025	Frigorifero con sbrinamento a pulsante Réfrigérateur avec degivrage à bouton Push button defrost Kuhlschrank abtau druckknopf	-31	-23	-13	-13	-5	+5		mm 1500
216 FR 30	VR 106 K 54 - H3400	Freezer Conservateur Freezer Gefrierschrank signal passiv	-32			-20	-20			mm 2000

TUTTI I VARIFIX DI QUESTA PAGINA HANNO I FASTON DA mm 4,8
TOUS LES VARIFIX ICI ILLUSTRES ONT LES COSSES DE mm 4,8
ALL VARIFIX SHOWN ON THIS PAGE HAVE THE FASTON mm 4,8
ALLE DIESE VARIFIX THERMOSTATEN HABEN FLACHSTECKHULSEN mm 4,8

atea

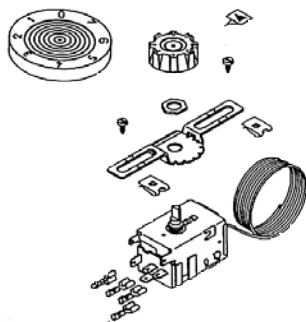

CODICE CODE CODE KODE	ARTICOLO ARTICLE ITEM ARTIKEL	APPLICAZIONE APPLICATION UTILIZATION	WARM IN/OUT °C	COLD IN/OUT °C	DEFROST	SIGNAL OPERATION	CAPILLARE CAPILLAIRE CAPILLARY KAPILLARE	NOTE REMARQUES REMARKS BEMERKUNGEN
216 FR 08	M2 - 1001 A 01 - 1001	Frigorifero normale Réfrigérateur normal Standard refrigerator Normalkulshrank	+1,5 / -6	-14 / -22			mm 1200	
216 FR 09	S2 - 1000 A 02 - 1000	Frigorifero con sbrinatorio semiautomatico Réfrigérateur avec dégivrage Sémi-automatique Refrigerator with semi - automatic defroster Kuhlschrank mit halbautomatischer Abtauvorrichtung	-2 / -9	-17 / -26	+6		mm 1200	
216 FR 10	C3 - 1000 A 13 - 1000	Frigorifero 2 porte Réfrigérateur 2 porte 2 door refrigerator Zweittüriger Kuhlschrank	+3 / -13	+3 / -26			mm 1200	3 contatti
216 FR 11	L3C - 1000 A 04 - 1000	Congelatore con allarme Congélateur avec alarm Freezer with alarm Gefrierschrank mit alarm	-12 / -18,5	-25 / -32			mm 2000	
216 FR 12	M2 - 1002 A 01 - 1002	Raffreddatori bibite Réfrigérateurs pour boissons Drink and bottles refrigerators Getrankekuhlschrank	+ 12 / +5	-0,5 / -8			mm 1500	
216 FR 31	C2 - 1000 A 03 - 1000	Frigorifero 2 porte Réfrigérateur 2 porte 2 door refrigerator Zweittüriger Kuhlschrank	+ 3 / -13	+3 / -26			mm 1200	2 contatti
216 FR 32	M2 - 1000 A 01 - 1000	Congelatore senza allarme Congélateur sans alarm Freezer without alarm Gefrierschrank ohne alarm	-12 / -18,5	-25 / -32			mm 2000	



216 FR 37

**UNIVERSALE
TIPO VARIFIX**

Termostato 2 porte
2 Doors thermostat
Capillare } 120 cm
Capillary }
3 Contatti - 3 Contact

**TIPO ECONOMICO
ECONOMIC TYPE**



216 FR 38

**UNIVERSALE
TIPO VARIFIX**

Termostato 2 porte
2 Doors thermostat
Capillare } 200 cm
Capillary }
3 Contatti - 3 Contact

**TIPO ECONOMICO
ECONOMIC TYPE**

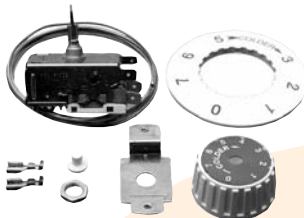

216 FR 39

**UNIVERSALE
TIPO VARIFIX**

Termostato con sbrinamento
Defrost thermostat
Capillare } 120 cm
Capillary }
2 Contatti - 2 Contact

**TIPO ECONOMICO
ECONOMIC TYPE**



216 FR 40

**UNIVERSALE
TIPO VARIFIX**

Termostato congelatore
Freezer thermostat
Capillare } 200 cm
Capillary }

**TIPO ECONOMICO
ECONOMIC TYPE**



216 FR 41

**UNIVERSALE
TIPO VARIFIX**

Termostato 2 porte no frost
2 Doors no frost thermostat
Capillare } 200 cm
Capillary }
3 Contatti - 3 Contact

**TIPO ECONOMICO
ECONOMIC TYPE**



SANKYO - TMDE 724 ZC

230 FR 00

IGNIS
PHILIPS
BAUKNECHT

Cod. orig. 481928218274



RANCO T25 - L5017

230 FR 10

IBERNA

6 HRS - 6 MIN
Colleg. motorino 1-3

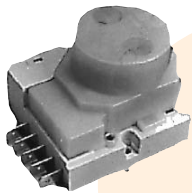

RANCO T25 - L5002

230 FR 07

KELVINATOR
CANDY

Cod. orig. 92236124
6 HRS - 25 MIN
Colleg. motorino 1-3



RANCO T25 - L5014

230 FR 17

ELINDA
VARI USI

8 HRS - 25 MIN

UNIVERSALE - KELVINATOR - CANDY
6 HRS - 25 MIN



RANCO T25 - L5004

230 FR 19

VARI USI
GENERAL USE

8 HRS - 18 MIN



TIPO ECONOMICO - ECONOMIC TYPE

230 FR 31

SANKIO

230 FR 32

PARAGON

230 FR 33

PACIFIC CONTROL

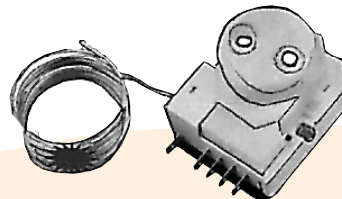

RANCO T24 - L0102

230 FR 22

VARI USI
GENERAL USE

6 HRS - 30 MIN
Capillare - 1800 mm

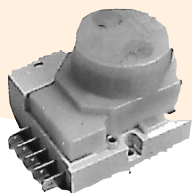

RANCO T25 - L5013

230 FR 08

KELVINATOR
CANDY

Cod. orig. 92913250
8 HRS - 7 MIN
Colleg. motorino 1-2

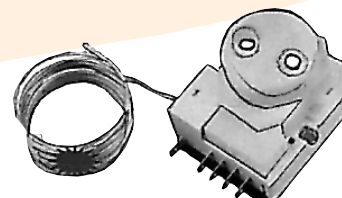

RANCO T24 - L0103

230 FR 23

VARI USI
GENERAL USE

12 HRS - 45 MIN
Capillare - 1800 mm

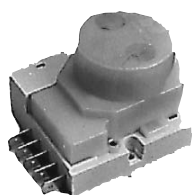

RANCO T25 - L5009

230 FR 15

KELVINATOR
CANDY

8 HRS - 7 MIN
Colleg. motorino 1-3

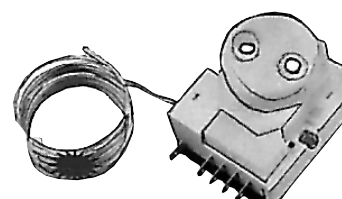

RANCO T24 - L0111

230 FR 24

VARI USI
GENERAL USE

8 HRS - 45 MIN
Capillare - 1800 mm

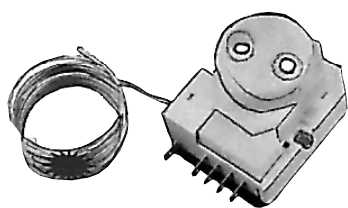

RANCO T24 - L6002

230 FR 25

**VARI USI
GENERAL USE**

12 HRS - 30 MIN
Capillare - 1800 mm



REK 31 E

230 FR 32

UNIVERSALE

Termostato elettronico + sonda
Electronic thermostat + probe
-55°/+99°C
Alimentazione 230 V



PRODIGY A/2000

230 FR 26

UNIVERSALE

Termostato ambiente
-35°/+35°C



REK 31 ED

230 FR 33

UNIVERSALE

Termostato elettronico
doppia sonda inclusa
Electronic thermostat
double probe included
-55°/+99°C
Alimentazione 230 V



PRODIGY F/2000

230 FR 27

UNIVERSALE

Termostato ambiente
-35°/+35°C
bulbo Ø 6 mm - 1400 mm



REK 33

230 FR 34

UNIVERSALE

Termostato elettronico
doppia sonda, ciclo di
sbrinamento e controllo
ventola evaporatore
Electronic thermostat
double probe,
with controlled
defrost cycles
and fan activity
-55°/+130°C
Alimentazione 12 V



ELIWELL EWPC 901/T

230 FR 28

UNIVERSALE

Termostato elettronico + sonda
Electronic thermostat + probe
-55°/+99°C
Alimentazione 12 V

**Fissaggio DIN
Size 4 DIN modules**

230 FR 35

UNIVERSALE

Termostato elettronico
doppia sonda, ciclo di
sbrinamento e controllo
ventola evaporatore
Electronic thermostat
double probe,
with controlled
defrost cycles
and fan activity
-55°/+130°C
Alimentazione 230 V



PTC

230 FR 29

UNIVERSALE

Sonda per 230 FR 28
Probe for 230 FR 28

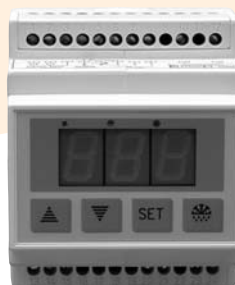

REK 43



EWTCM

230 FR 30

UNIVERSALE

Trasformatore per 230 FR 28
Transformer for 230 FR 28
220 V-12 V 50/60 Hz



230 FR 36

UNIVERSALE

Sonda - Probe
per/for
230 FR 34
230 FR 35