

## LL675 IF-module

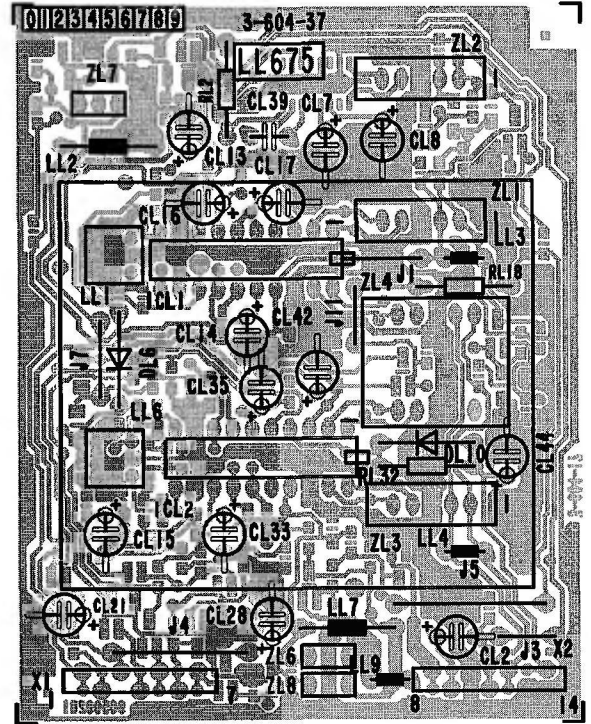

## SW600 Switch module

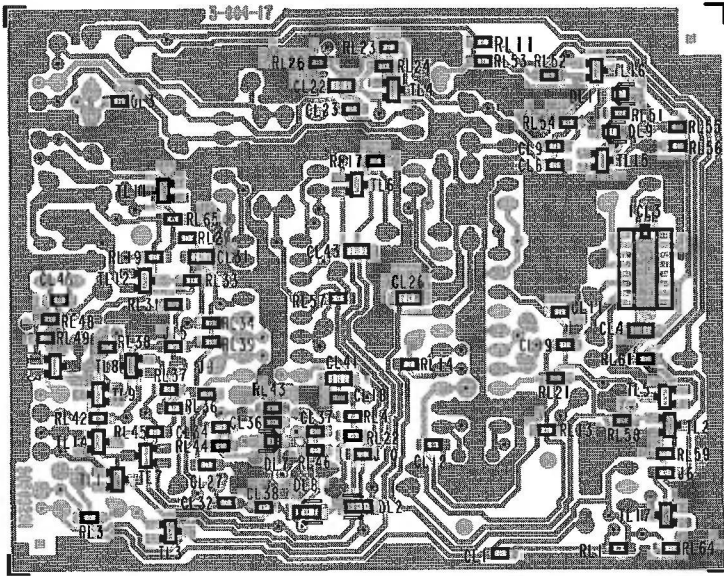
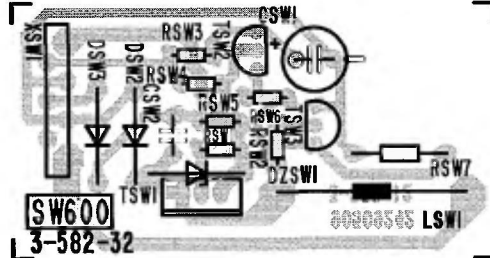

## SW600 Switch module

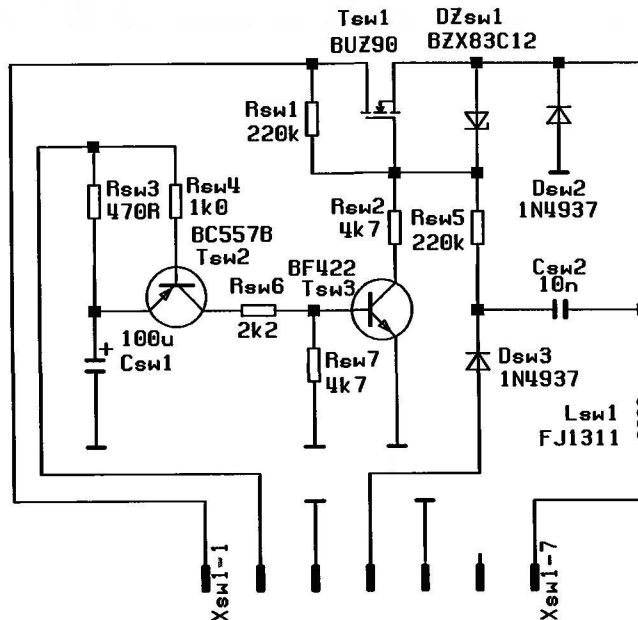

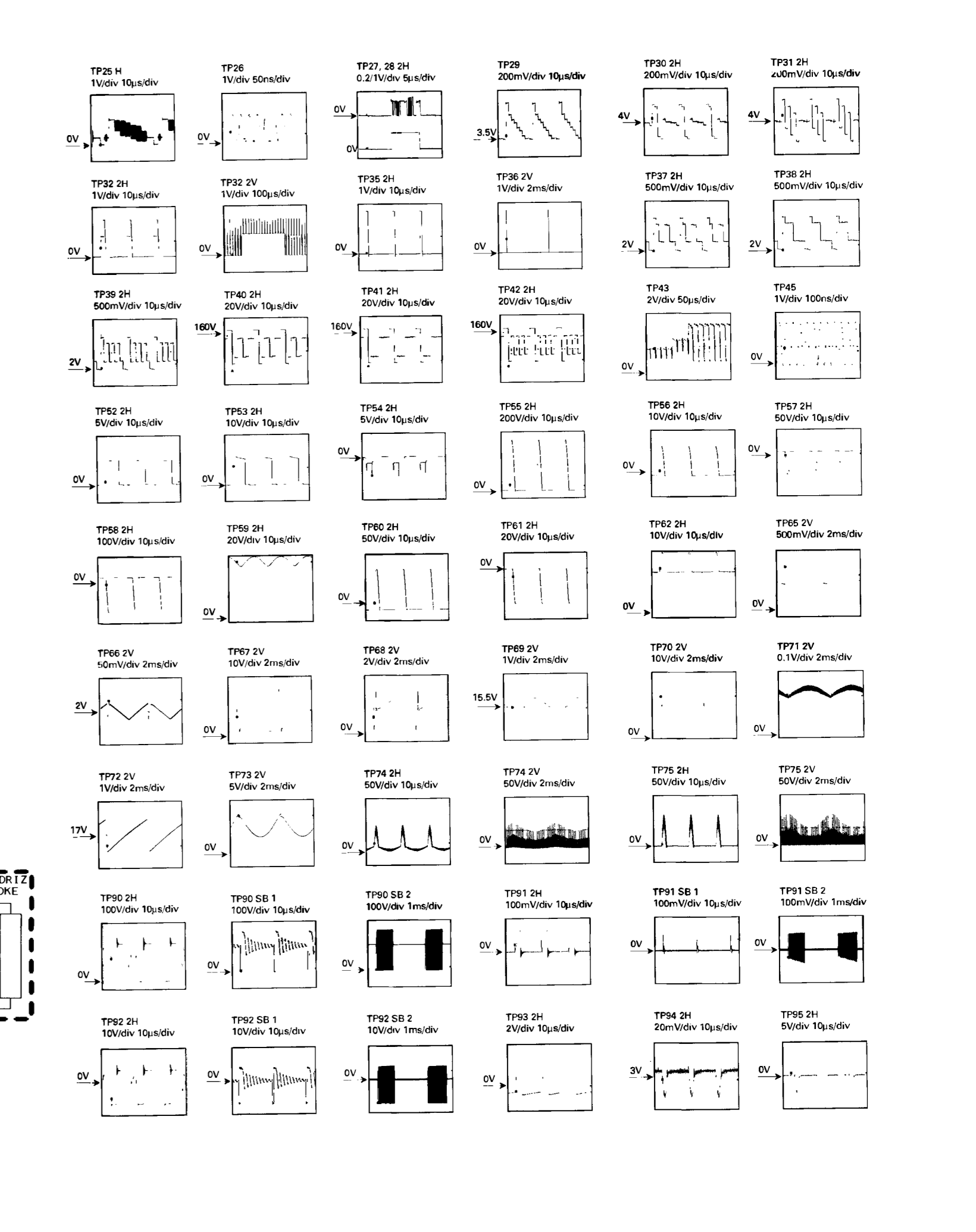
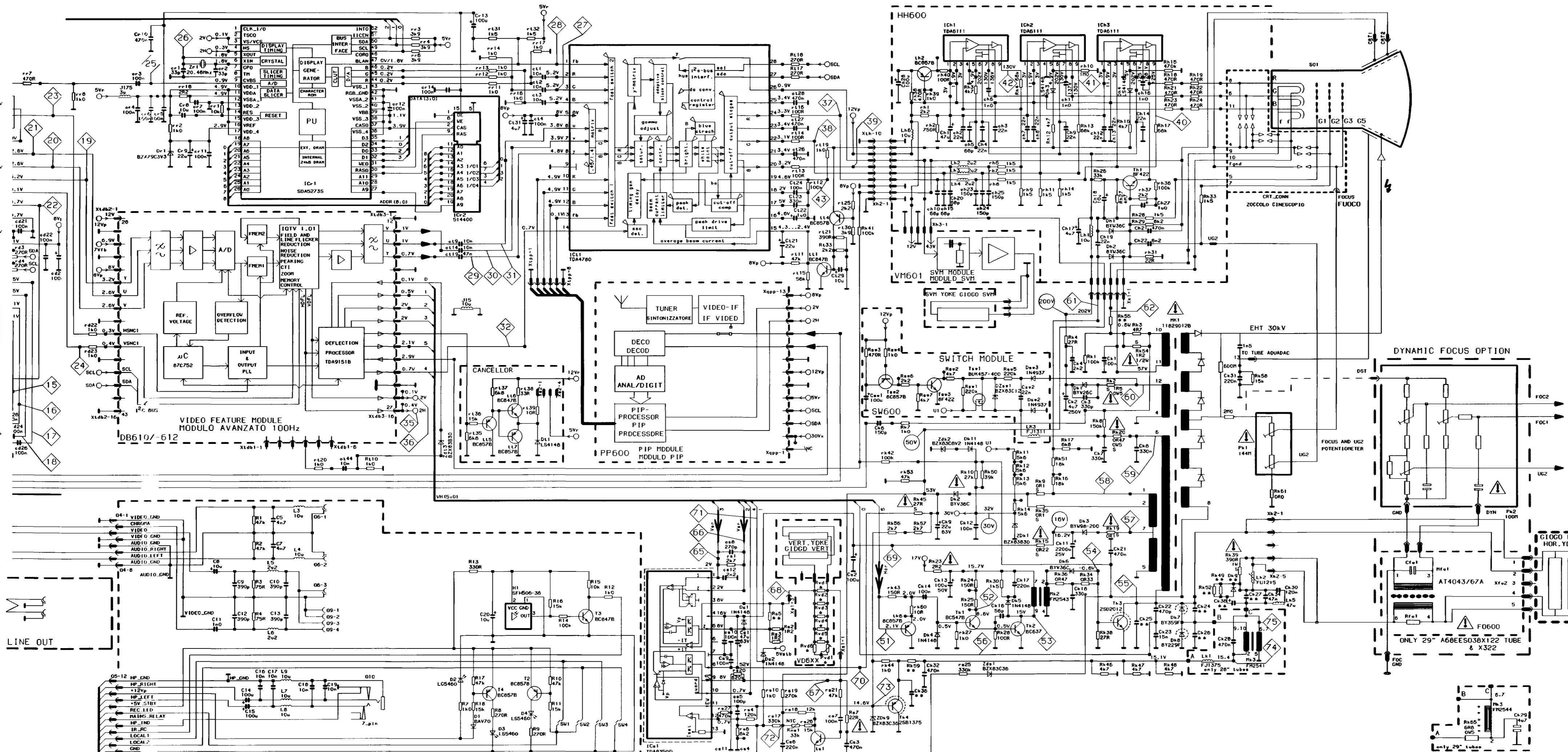
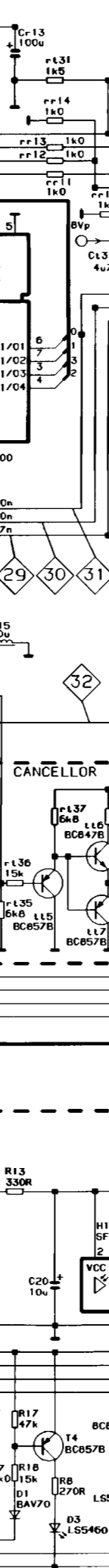
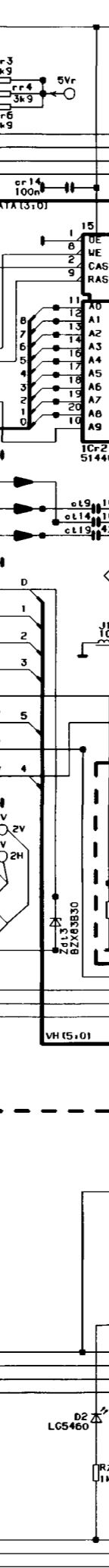
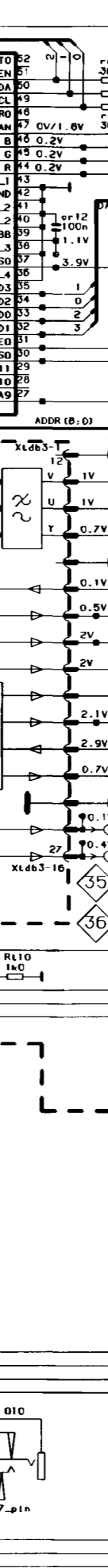
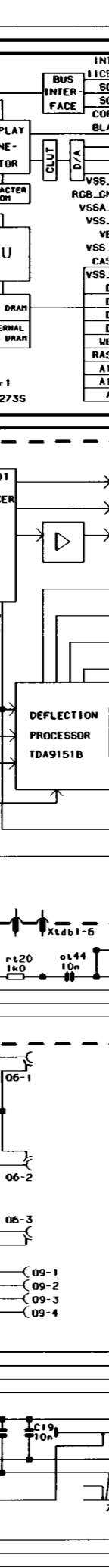
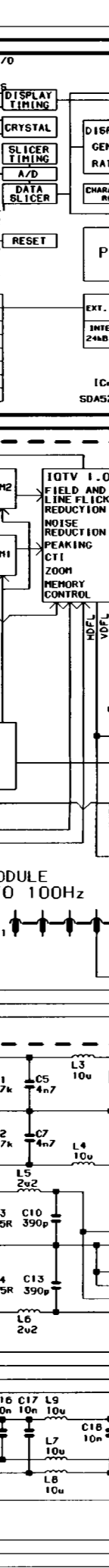
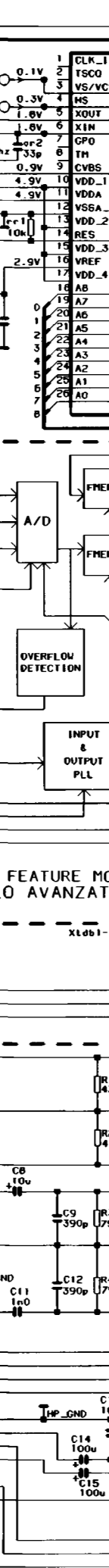
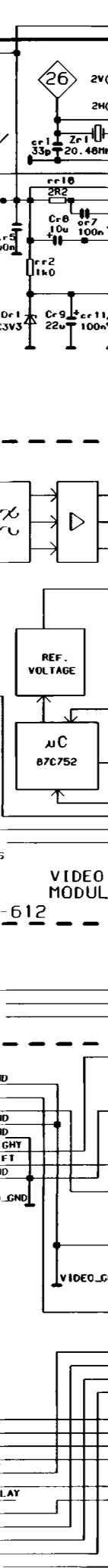
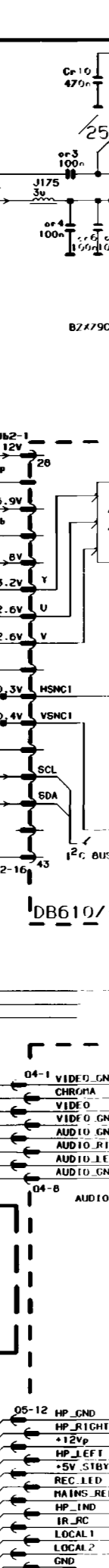
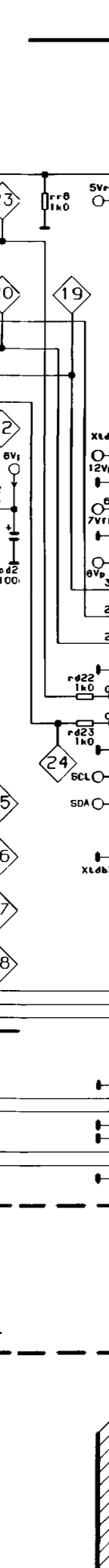
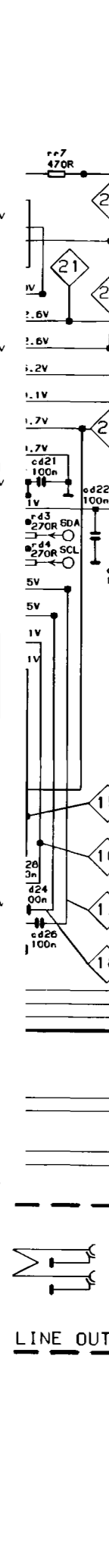
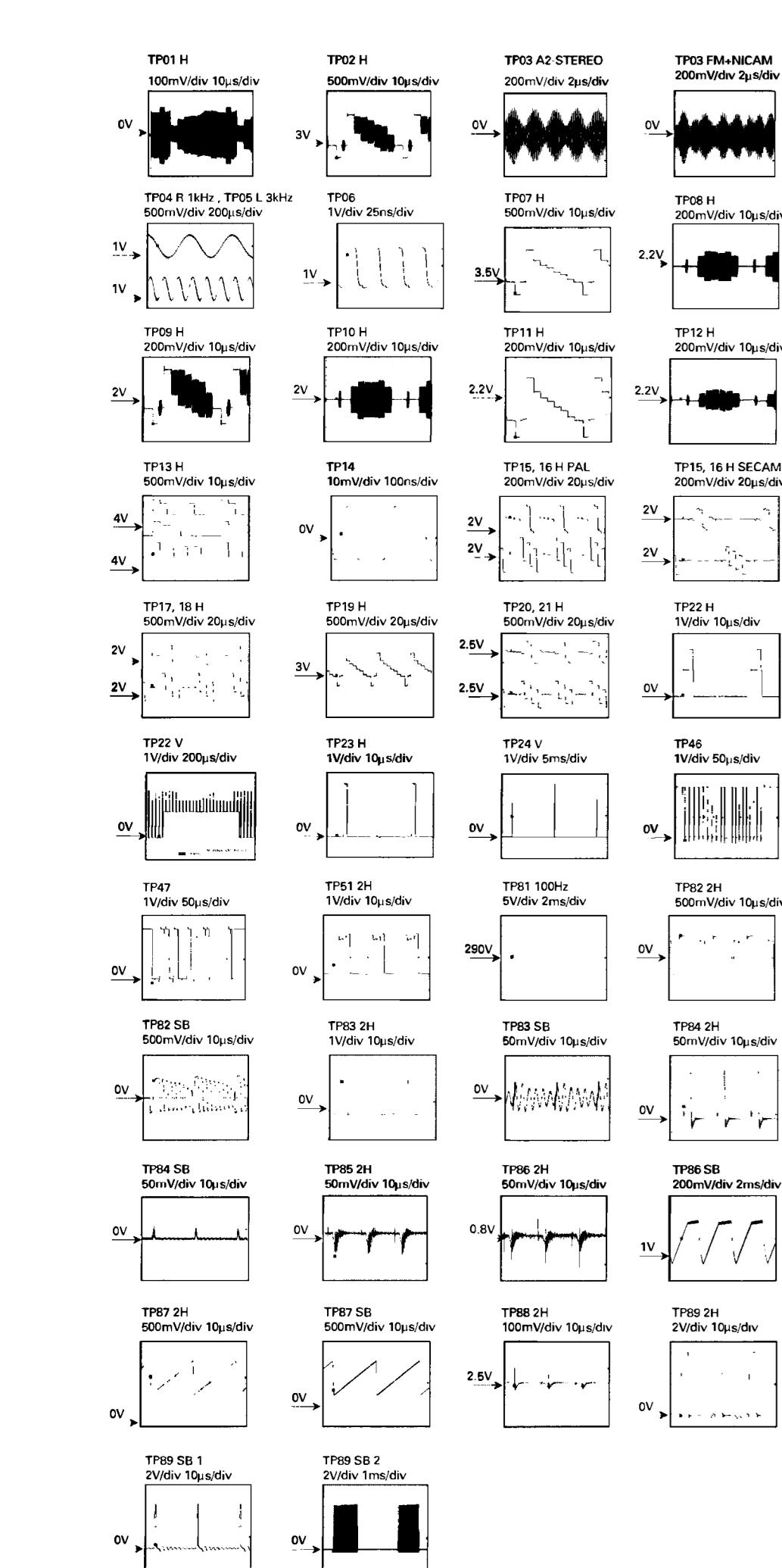

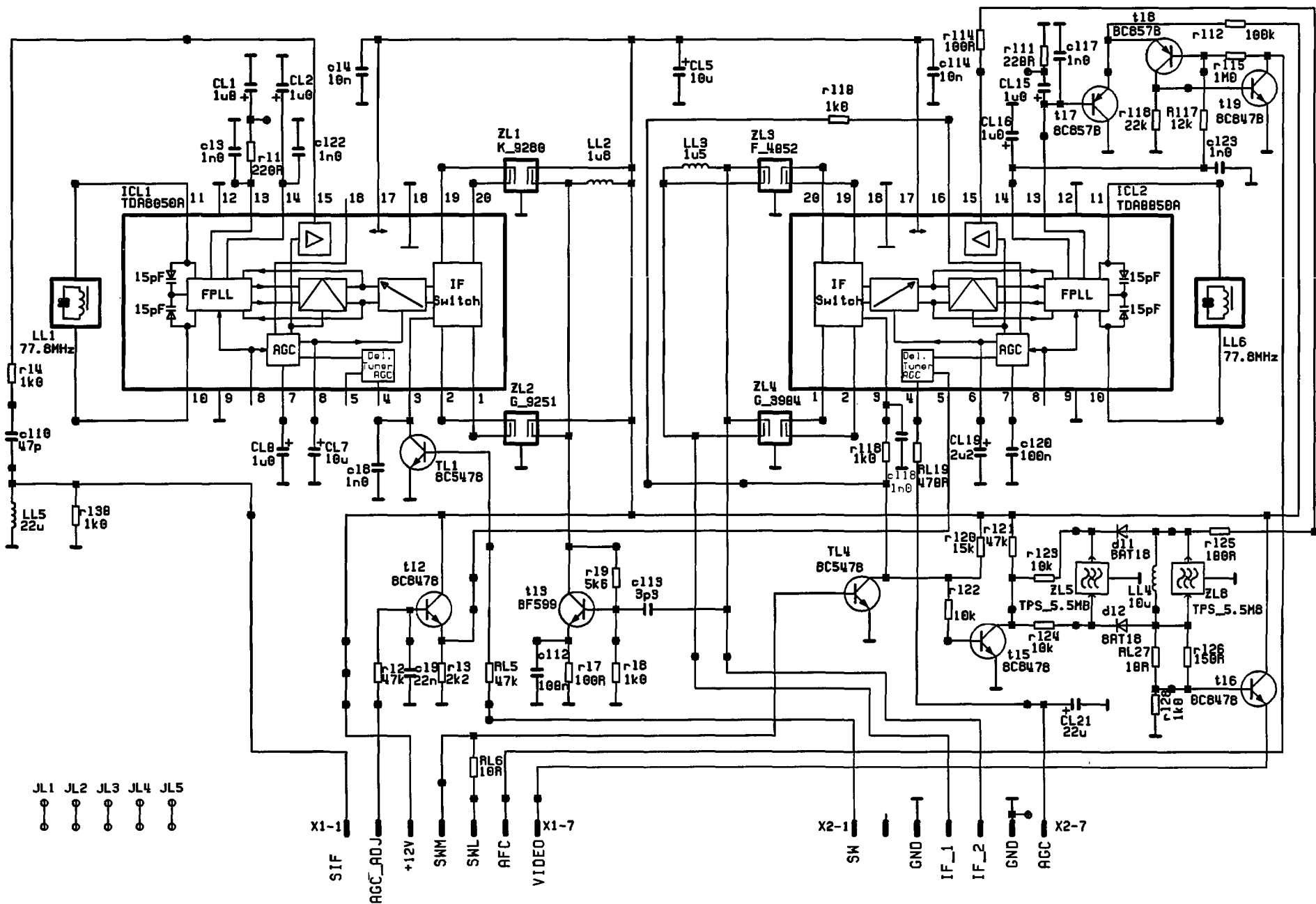

L600 IF-module

# VM600 SVM module

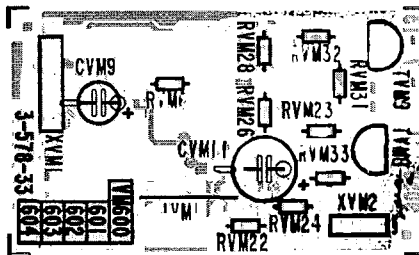
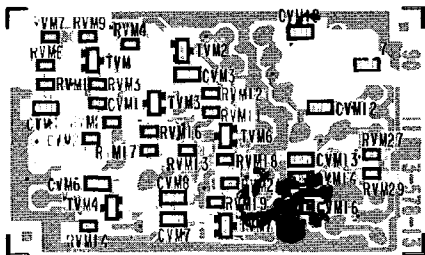

# VM600 SVM module

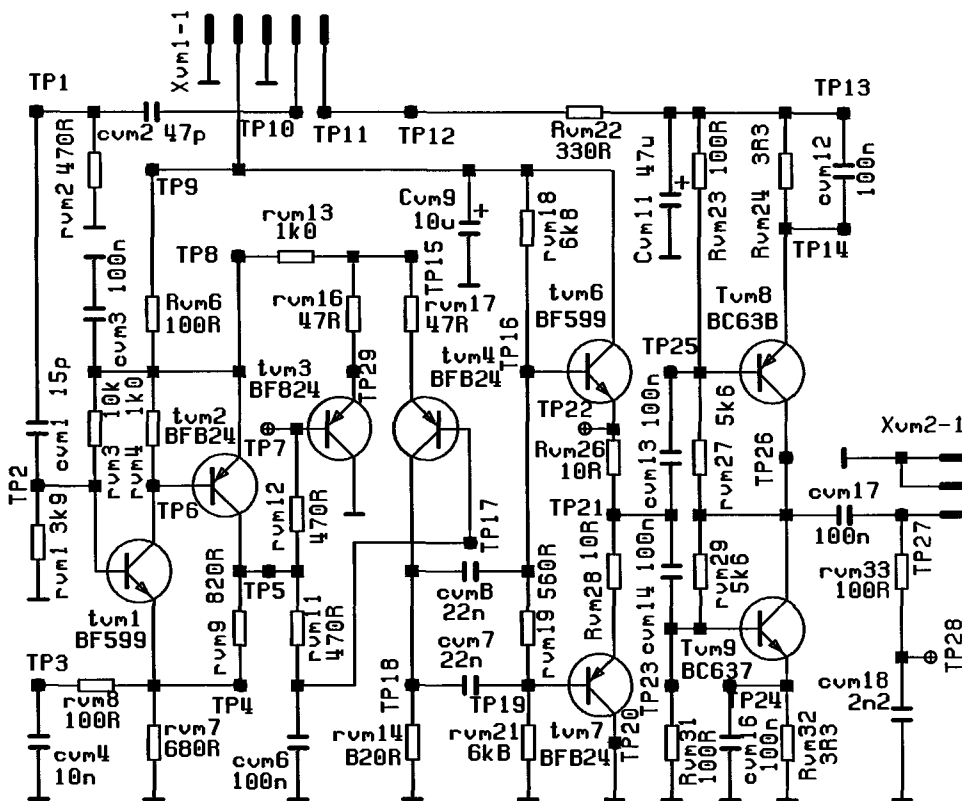

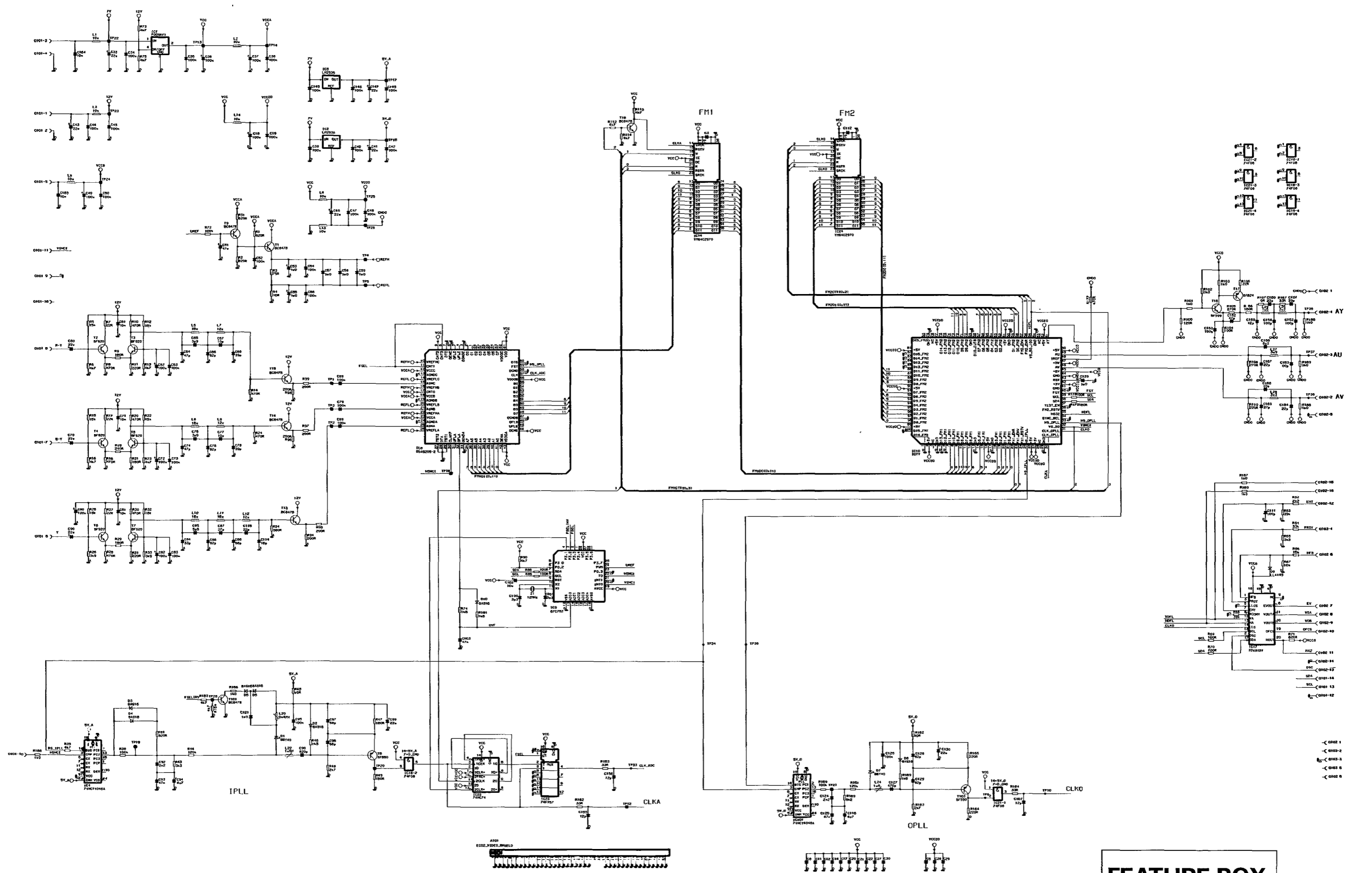

**FEATURE BOX  
DB610**

6611 72 45

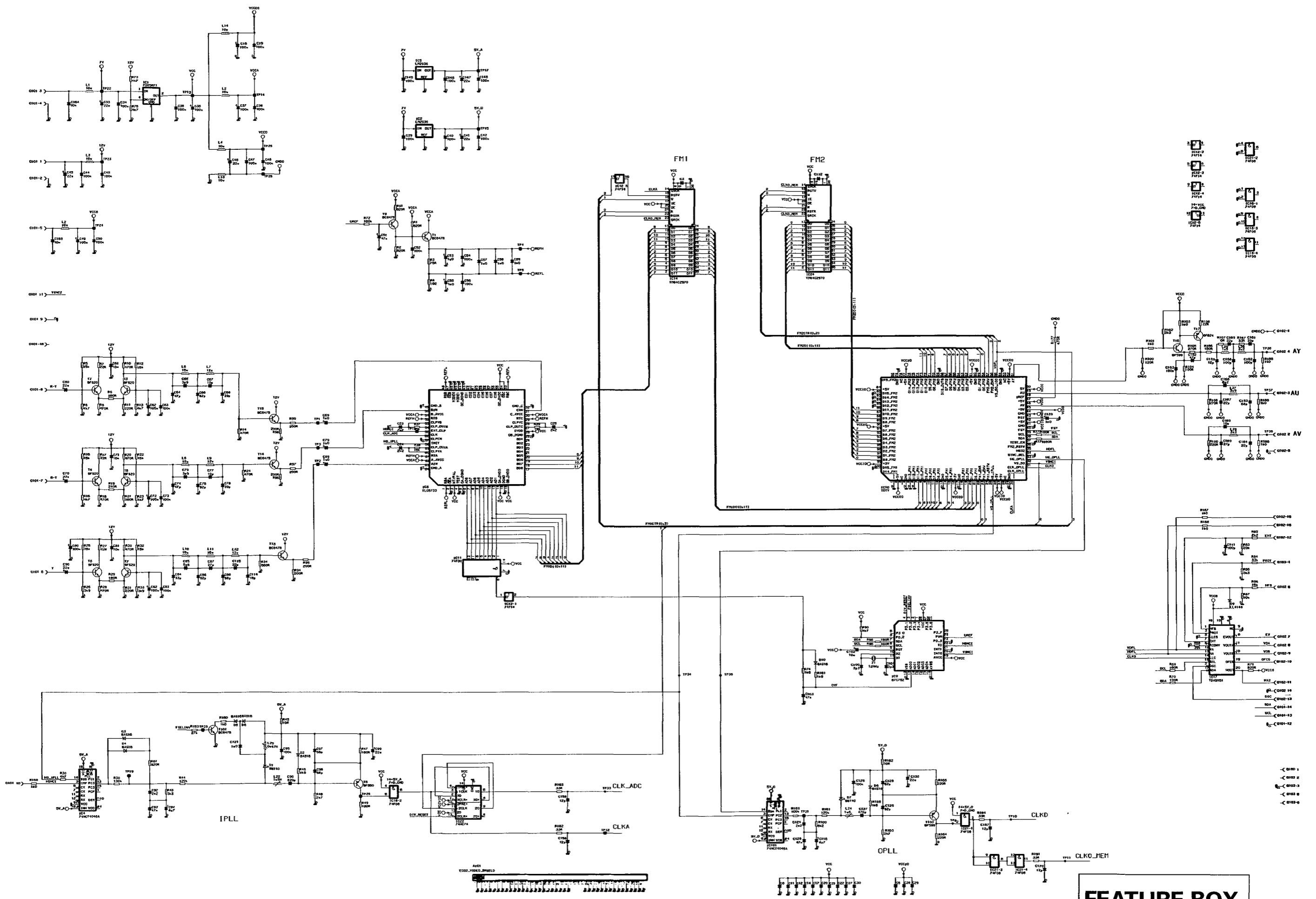

**FEATURE BOX  
DB612**

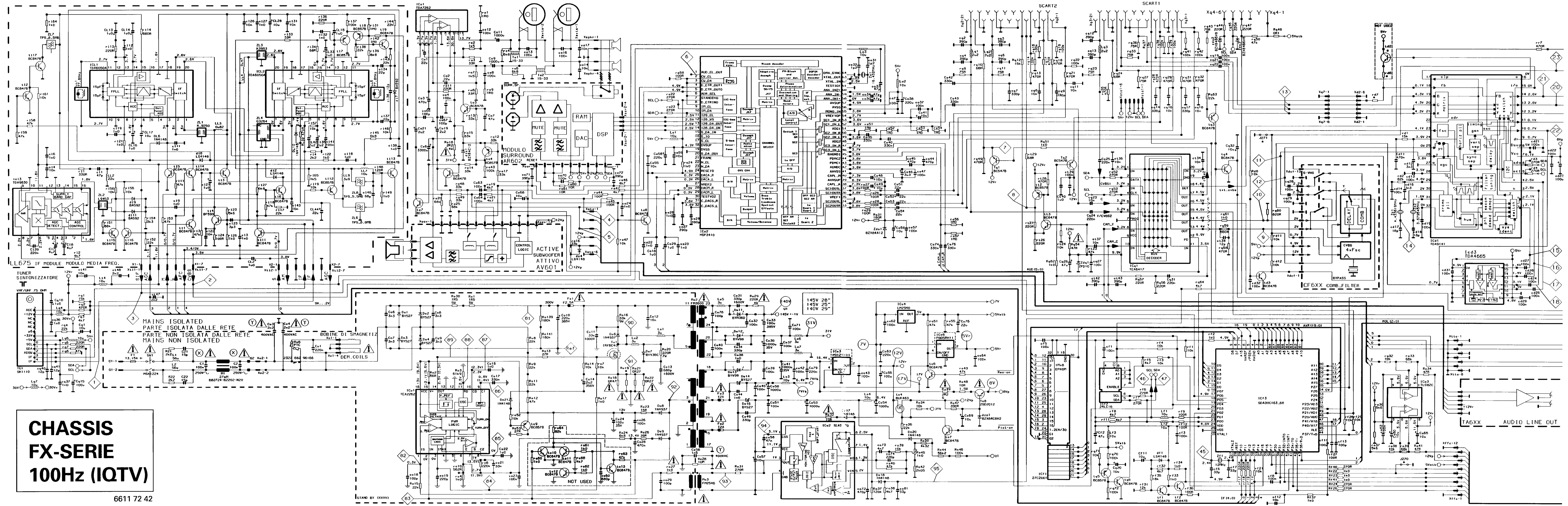

**CHASSIS  
FX-SERIE  
100Hz (IQTV)**

6611 72 42

STAND BY (XXXX)