

Miditron[®] Junior *II*

Service Manual



Table of contents

Short operating instructions	6
1. General Note	7
1.1 Limitations	7
1.2 Mailing / telephone address	7
1.3 Security advice	8
1.4 Confirmation declaration	10
2. Documentation	11
2.1 Update service for this manual	11
2.2 Instrument code for service	11
3. Introduction	12
3.1 System description	12
3.1.1 Function Elements	13
3.1.2 Measuring Principle	15
3.1.3 Concentration Table (Program I)	17
3.1.4 Changing Range Remisson Bordes	18
3.2 System Specification	19
3.3 Service Concept	20
3.3.1 Service level	20
3.3.2 Handling of warranty and repairs	20
4. Installation	25
4.1 Checking for Damage in Transit	25
4.2 Unpacking	25
4.3 Proper Setting	25
4.4 Setting Up	25
4.5 Inserting Printer Paper	27
5. Calibration	28
6. Operation	31
6.1 Overview	31
6.2 Normal Mode	32
6.3 Accelerated Mode	32
6.4 Fast Mode	32
6.5 Principle movement of the Miditron® Junior II	33
7. Service mode and adjustment	34
7.1 How to make adjustments	34

Table of contents

7.2	General	35
7.3	Procedure	35
8.	Adjustment / Dismantling	40
9.	Mechanics	41
9.1	Mechanical moduls	41
9.1.1	Transport arm	41
9.1.2	Tray	41
9.1.3	Top of housing.....	42
9.1.4	PCB Main	43
9.1.5	PCB Interface	44
9.1.6	Display	45
9.1.7	Printer	46
9.1.8	Status LED	47
9.1.9	Keyboard	48
9.1.10	PCB Measuring Head	49
9.1.11	LB Measuring Head Home Position	50
9.1.12	LB Home Position	51
9.1.13	Motor Belt Drive Cross Transport.....	52
9.1.14	Motor Measuring Head Unit	53
9.1.15	Tooth Bar Measuring Head Unit	54
9.1.16	Carrier for tray	55
9.1.17	Reference Field Carrier	56
9.1.18	Crossbar complete	57
9.1.19	CrossTransport	58
10.	Electronics	59
10.1	Overview Electronics	59
10.2	Power supply	60
10.3	Electronic modules	62
10.3.1	PCB Main	62
10.3.2	PCB Interface	65
10.3.3	Display	67
10.3.4	Printer	67
10.3.5	Status LED	67
10.3.6	Keyboard	68
10.3.7	PCB Measuring Head	68
10.3.8	LB Measuring Head Home Position	69
10.3.9	LB Home Position	69

Table of contents

10.3.10	LB reference position	70
10.3.11	Motor Belt Drive Cross Transport	70
10.3.12	Motor Measuring Head Drive	71
10.4	Circuit diagram	72
10.4.1	PCB Main	72
10.4.2	PCB Interface	77
10.4.3	PCB Measuring Head	81
11.	Software	82
11.1	Overview	82
11.2	Flow Diagram of Menu Selection	83
11.2.1	Flow Diagram of the Worklist Menu	84
11.2.2	Flow Diagram of the Working Mode Menu	85
11.2.3	Flow Diagram of the Reprint Menu	86
11.2.4	Flow Diagram of the Setup Menu	87
11.2.4.1	Flow Diagram of Color Setup	89
11.2.4.2	Flow Diagram of Clarity Setup	90
11.2.4.3	Flow Diagram of Parameter Setup	91
11.3	Service/Status Software	92
11.4	Software update	92
11.4.1	Software update via chip cards	92
11.4.2	Software update via printer interface	93
11.5	Loading instrument settings via Download	97
11.5.1	Specification of the INI-file	98
11.6	Saving instrument settings via Upload	100
12.	Interface	101
12.1	Host Interface	101
12.2	Character definitions, representation conventions	102
12.3	Protocols	103
12.4	Upload timing and handshake	106
12.5	Download timing and handshake	108
12.6	Protocol structure	110
12.6.1	Protocol "/REP/": Repeat request	110
12.6.2	Protocol "/SPM/": Start Communication	110
12.6.3	Protocol "/MOR/": Receipt confirmed/Request for next set	110
12.6.4	Protocol "/END/": End of communication	110
12.6.5	Protocol "/SPE-D/ + Data": Data protocol color + turbidity	111

Table of contents

12.6.6	Protocol "/SPE-E/ + Data": Data protocol results	111
12.6.7	Protocol "/SPE-A/ + Pat-Id.": Data protocol Pat-Id.	112
12.7	Format of results-data :	112
12.7.1	Structure of results-data Programm-1 (International) :	112
12.8	Procedures for checking test bytes	114
12.8.1	European language variations of Mditron® software: LRC test bytes	114
12.8.2	American/Canadian language version of Mditron® Junior II software:	115
12.8.3	Automatic adaption to the test procedure used by the host	116
13.	Troubleshooting	117
13.1	Error at self-test	117
13.2	Repairable errors during normal mode	118
13.3	Non-repairable errors during normal mode (Major Error)	119
13.4	Errors during INI-file Download	120
13.5	List of all error codes	121
14.	Spare Parts	127
14.1	Complete spare part list	127
14.2	Part identification	128
14.3	Exploded view Mditron® Junior II	131
15.	Instrument, Strips, Accessories	133
15.1	Complete list	133
16.	Interface Assignment	134
16.1	Host/PC interface	134
16.2	External Printer interface	135
16.3	Barcode reader interface	135
17.	Routine Care and Cleaning	136
17.1	General	136
17.2	Cleaning	136

Short operating instructions

Directions in Brief



Please read carefully the sections marked with this symbol in the margin!

Miditron[®] Junior II is designed for ease of use. To carry out routine strip measurements in Normal Mode (sequential reading with automatic consecutive numbering), proceed as follows:

Switch on **Miditron**[®] Junior II. You see displayed:

Please empty the waste tray.

Empty Waste Tray

"Please empty the waste tray"

Once the waste tray is empty and the self-check has finished, the analyzer is ready. You see displayed.

READY - <START>

"The analyzer is ready to measure"

1. Press **<Start>** and follow the display messages:
2. When the status LED flashes green and the beep tone sounds ("Dip Strip 1" is displayed), briefly dip the test strip in the urine sample (for about 1 second) and then remove it again, drawing the edge of the strip over the rim of the specimen container to wipe off excess urine.
3. While the status LED is green, you may insert the test strip, reagent zones upwards, into the insertion area between the two guides on the leading edge of the strip receiving tray.
The end of the test strip must be supported by the rear inside edge of the strip receiving tray (Fig. 10).



WARNING: To prevent injury, keep hands away from the analyzer when it is transporting test strips!

4. After about 20 seconds the first test strip will be transported from the waiting position to the measuring position and "Please Wait" will be displayed. When the display shows "Dip Strip 2", repeat the procedure for the second and any subsequent test strips.
5. The first test strip will be measured 60 seconds after it was dipped and the result will be automatically printed as long as the internal printer was not disabled in the SETUP menu. When a strip is no longer detected at the measuring position, **Miditron**[®] Junior II automatically returns to the initial state ("READY - <START>" is displayed).

IMPORTANT:

Before operating Miditron[®] Junior II for the first time, you have the option of entering various settings in the SETUP menu.

For your own safety, and to avoid operator errors, please read the following operating instructions carefully.

Please refer to the relevant sections of the Operator's Manual for information on selection of SETUP menu options, calibration, working with Patient ID's, cleaning and maintenance.

1. General Note

1.1 Limitations

The data and information provided in this manual correspond to the state of knowledge existing at the time of introducing the **Miditron**® Junior II on the market. Any important changes will be taken into account in the next edition of this manual.

The packaging leaflet should be regarded as authoritative.

This service manual was created for the telephone service and technical service staff.

The operation manual contains special information for the telephone service.

1.2 Mailing / telephone address

Service department, DA-ST

Telephone: +49 (0) 621 / 759 / 3227

Fax: +49 (0) 621 / 759 / 3985

Hot-line logistic (RA)

Telephone: +49 (0) 621 / 759 / 8094

Fax: +49 (0) 621 / 759 / 8093

When calling from outside Germany, add the international dialing code at the beginning and omit the first '0'.

1. General Note

1.3 Security advice



Please carefully read the paragraphs marked by a warning triangle!



This instrument was constructed in accordance with DIN VDE 0750, Part 1/DIN IEC 601, Part 1, “Medical Electrical Equipment; Part 1: General Requirements for Safety” and checked to meet all technical demands on safety before leaving the factory.



The instrument received the „GS“ (Geprüfte Sicherheit = safety-tested) label for meeting the safety requirements of the VDE (Verein Deutscher Elektronik-Hersteller = Society of German Electronics Manufacturers) and meets the requirements of the MedGV (Medizinische Geräteverordnung = Medical Instrument Regulation).

To maintain these conditions and guarantee safe operation, the operator should read this information and observe the warnings given in these operating instructions.

The instrument should be used only with the external power supply included in the delivery.

This instrument belongs to Protection Class I (protective conductor).

Do not insert the plug into any type of AC outlet other than a shock-proof outlet. Do not use an extension cord without a protective conductor to prevent that the protective effect is circumvented.



Interrupting the earth conductor inside or outside of the instrument or disconnecting the earth conductor lug may create a hazardous situation for the operator.

Do not open the covers or remove parts that cannot be opened or removed by hand, as this can expose live parts. Connectors may also be live. Any adjustment, maintenance or repair on an opened instrument with the power on should be carried out only by trained personnel authorized by Roche Mannheim who are aware of the danger involved.

If you suspect that the instrument can no longer be operated safely, turn it off and take steps to ensure that it cannot be turned on accidentally. Make certain that the **Miditron® Junior II** is operated by trained personnel only.



To prevent injury, keep hands away from the analyzer when it is transporting a strip.

A personal computer or printer connected to the analyzer

1. General Note

must meet the regulations of EN 60950, UL 1950 or CSA C22.2 No. 950.

General Information:

The data and information contained in this manual are current as of issue. Any basic changes will be included in subsequent editions. In case of uncertainty, the package insert included with the product in question shall prevail.

The instrument meets the requirements of Overvoltage Class 2 and Pollution Class 2.

Medical Instrument Regulation („MedGV“)

MedGV is a safety regulation for technical medical instruments (effective only in Germany).

According to the MedGV of 01/14/85, the **Miditron**[®] Junior *II* is classified in Group 3. The user must follow the proper guidelines for Group 3.

Reference:

Regulation on Safety of Technical Medical Instruments.

Author: Adolf Krebs, ISBN 3-921958-41-S, 1985 Bibliomed.
Published by: Medizinische Verlagsgesellschaft mbH,
Melsungen.

Miditron[®] Junior *II* should be used by qualified persons only.

1. General Note

1.4 Confirmation declaration

Confirmation declaration for electromagnetic compatibility according to the laws of the European Union.

**BOEHRINGER
MANNHEIM**
LAB DIAGNOSTICS



EC Declaration of Conformity

Manufacturer: Boehringer Mannheim GmbH

Address: Boehringer Mannheim GmbH
Sandhofer Straße 116
D-68305 Mannheim

Boehringer Mannheim GmbH declares that the product:

Product name: Miditron® Junior II

to which this declaration relates, meets the protection requirements laid down in Council Directive 89/336/EEC on the alignment of the legal provisions of the Member States on electromagnetic compatibility.

To assess the product with regard to electromagnetic compatibility, the following relevant harmonised European standards were consulted:

EN 50 082-2 / 1995-03
'Electromagnetic compatibility, Generic immunity standard,
Part 2: Industrial environment'

EN 55 011 / 1991-03 (Class B)
'Specification for limits and methods of measurement of radio disturbance characteristics of industrial, scientific and medical (ISM) radio-frequency equipment'

Mannheim, March 1998
Boehringer Mannheim GmbH

ppa. Dr. Hecker
Senior Vice President Instrumentation Diagnostics

De Caluwé
Director Instruments Evaluation

Contact address: Boehringer Mannheim GmbH, Abteilung Evaluierung Geräte
Sandhofer Straße 116, D-68305 Mannheim, Telefax: +49 621/759 3009

2. Documentation

2.1 Update service for this manual

New information and modifications will be sent via Technical News. Please send us your name and address to ensure you receive updates automatically.

Update Service:

Fax this page to Technical Service-Roche Mannheim
+49 (0)621 759 3985

Name:.....

Address:.....

.....

.....

FAX No. + _____

You will find the version identification in the bottom line of every page.

Explanation of the index:

Service Manual **Miditron**[®] Junior *II* / ID 1702602 / MJ / Vers.
1.0 - June 1998 / Page 5

Instrument:	Miditron [®] Junior <i>II</i>
Order- number:	1702602
Instrument code:	MJ
Version:	1.0
Date of edition:	June 1998
Page:	5

2.2 Instrument code for service

The service code of **Miditron**[®] Junior *II* is: **MJ**

3. Introduction

3.1 System description

Urine test strips simplify laboratory diagnosis through their ease of use, sensitivity and specificity. These benefits allow you to identify pathological changes in the urine quickly and reliably.

Automated urinalysis with **Miditron**[®] Junior II assures that the reading of results is standardized by eliminating potential sources of error associated with visual reading of test strips (such as unfavourable lighting conditions at the workplace, differences in operators' ability to discriminate between colours and keep to prescribed times, etc.). The test strips used are multi-parameter strips for measuring specific gravity, pH, leukocytes, nitrite, protein, glucose, ketone, urobilinogen, bilirubin and erythrocytes in urine.

3. Introduction

3.1.1 Function Elements

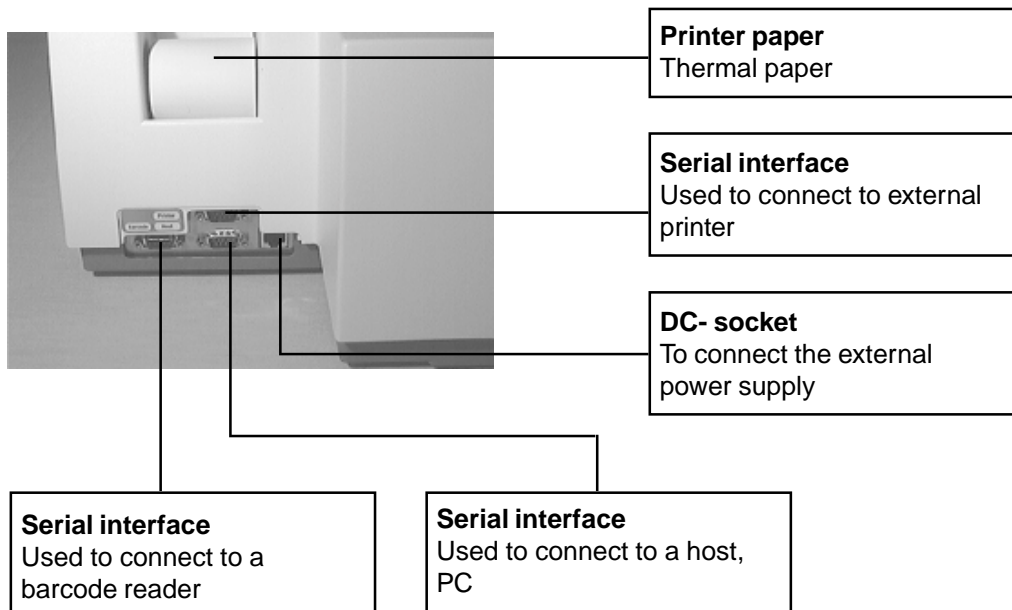
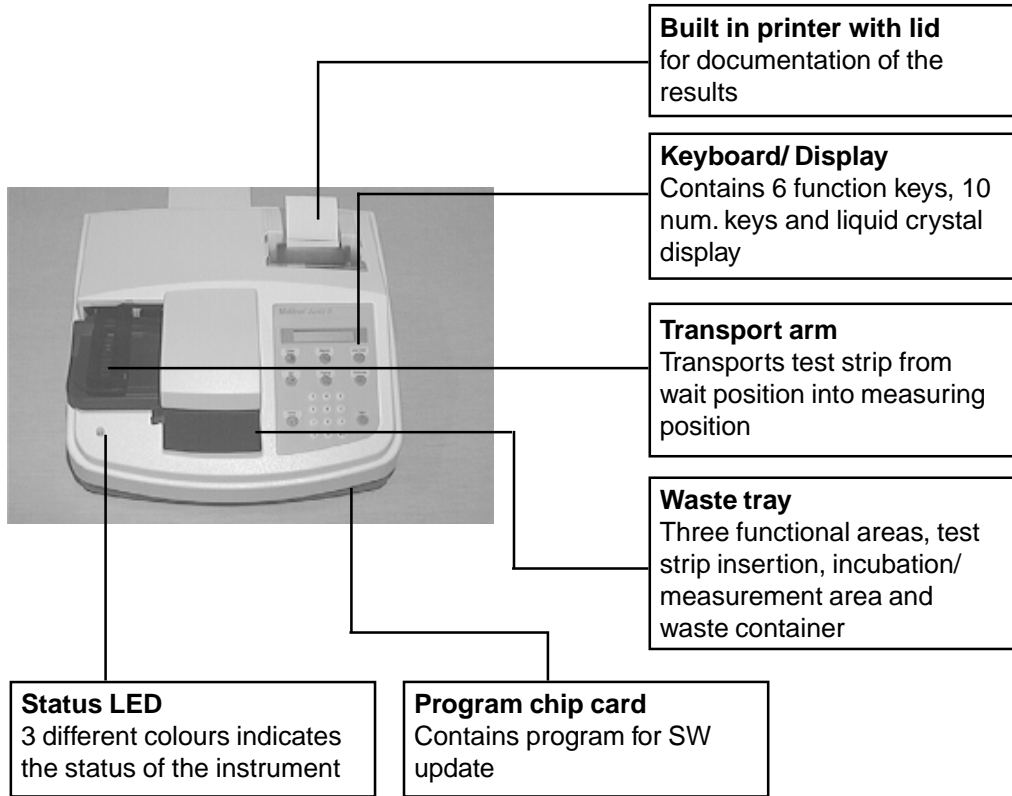

3. Introduction

Color

For manually selecting colour and clarity for inclusion with results.

Reprint

Reprints the patient report(s) as defined in the Reprint menu.

Display

The display consists of 1 line of 16 characters.

Set

Used to select a menu option.

Enter

Used to terminate keyboard input, e.g. <0-9> and to confirm an option or a procedure.

<0-9> and <.>

Used to enter (alpha) numeric values.

External power supply, provides the instrument with +5V DC and +12V DC

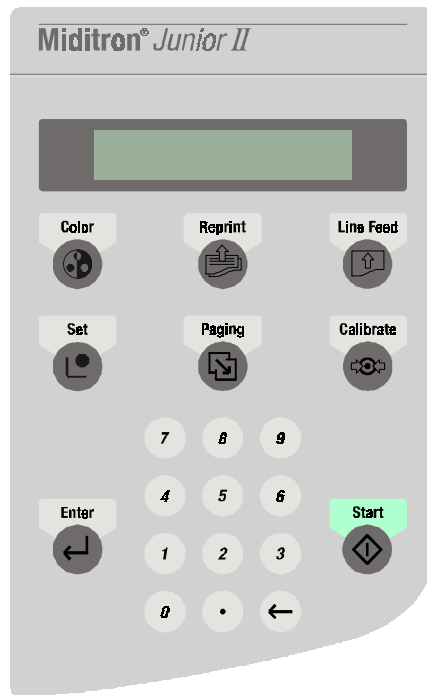
**Line Feed**

advances paper one line at a time or advances continuously while key is depressed

Calibrate

Starts the calibration procedure.

Paging

Used to scroll forwards vertically through menus without branching to menu options and without saving settings.

Start

Used to start test strip measurement, also to escape from menus back to "READY - <Start>", "ACC MODE Start" or "FAST MODE <START>", to stop printing during Reprint, and to acknowledge warning messages and prompts.



Backspace key for correcting input, scrolling backwards or jumping back one

Power cord

(Country specific)

3. Introduction

3.1.2 Measuring Principle

Miditron[®] Junior II is a semi-automated reflectance photometer for in-vitro semi-quantitative reading of urine test strips from Roche Mannheim. The light sources (light-emitting diodes, LED's for short) and reading times are optimized for the reaction chemistry and colour development occurring on the test pads.

The measuring head of **Miditron**[®] Junior II contains 3 LED's of differing wavelengths. The test strip is held stationary at the measuring position and the measuring head moves over each test pad in turn, starting from a "Reference position" used to test the optical system.

During measurement, **Miditron**[®] Junior II checks that the test strip is properly positioned under the measuring head by carrying out a plausibility check on the light that is reflected. If the strip is not properly positioned under the measuring head, **Miditron**[®] Junior II prints an error message.

Reading is done electro-optically, as follows:

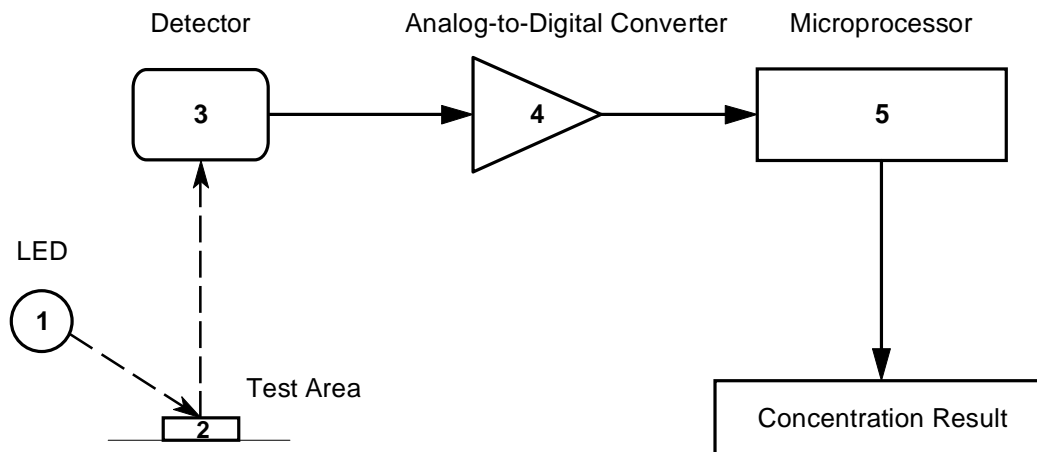

An LED (1) flashes light of a defined wavelength at an optimum angle onto the surface of the test pad (2). The light hitting the surface is reflected with an intensity that is dependent on the colour of the test pad, and is received by a photodiode detector (3) positioned directly above the test pad. The detector sends an analogue electrical signal to the analogue-to-digital converter (4), which converts it to a digital figure. The microprocessor (5) corrects the digital figure based on a value from an internal reference pad and converts it to a relative value by scaling to a calibration standard, and then computes the absolute reflectance value.

3. Introduction

The semi-quantitative concentration result is determined by comparing the absolute reflectance value with the so-called range boundaries (= constant, parameter-specific reflectance values stored in the analyzer).

Results can be printed out, saved in memory, and sent to a computer.

The wavelengths of the LED's used to measure each of the urine test strip parameters are listed in the table below. The results of certain parameters are improved through the use of two different wavelengths. The third LED is for future options

Parameter	Measuring Wave length [nm]
Specific Gravity	620
pH	557 and 620
Leukocytes	557
Nitrite	557
Protein	557
Glucose	557
Ketone	557
Urobilinogen	557
Bilirubin	557
Erythrocytes	557 and 620
Color	557 and 620

The photometric reflectance measurement for all of the parameters is carried out after an incubation time of 60 seconds. As with earlier urine analyzers from Roche Mannheim, allowance for intrinsic urinary colour, which is a recognized interfering factor, is made through measurement of a blank reagent pad, the so-called "compensation pad". Upon immersion into the urine sample, the compensation pad absorbs the sample liquid and assumes the intrinsic colour of the urine. Measuring the compensation pad helps prevent false positives when the urine sample is strongly coloured.

In strongly alkaline urine samples, **Miditron**® Junior II automatically corrects the result obtained when the test pad for specific gravity is read.

Miditron® Junior II reads the strip and determines urine colour by evaluating the compensation pad. The settings necessary for this are selected in the Setup menu. Whether the colour is to be printed together with the results is also defined in the Setup menu.

3. Introduction

3.1.3 Concentration Table (Program I)

Miditron® Junior II prints the test results in the following concentration ranges:

Parameter	Conventional	SI	Arbitrary (Standard)
Specific Gravity (SG)	1.000	1.000	1.000
	1.005	1.005	1.005
	1.010	1.010	1.010
	1.015	1.015	1.015
	1.020	1.020	1.020
	1.025	1.025	1.025
	1.030	1.030	1.030
pH	5	5	5
	6	6	6
	6.5	6.5	6.5
	7	7	7
	8	8	8
	9	9	9
Leukocytes (LEU)	neg.	neg.	neg.
	25 / μ l	25 / μ l	+
	100 / μ l	100 / μ l	++
	500 / μ l	500 / μ l	+++
Nitrite (NIT)	neg.	neg.	neg.
	pos.	pos.	pos.
Protein (PRO)	neg.	neg.	neg.
	25 mg/dl	0.25 g/l	+
	75 mg/dl	0.75 g/l	++
	150 mg/dl	1.5 g/l	+++
	500 mg/dl	5 g/l	++++
Glucose (GLU)	norm.	norm.	neg.
	50 mg/dl	3 mmol/l	+
	100 mg/dl	6 mmol/l	++
	300 mg/dl	18 mmol/l	+++
	1000 mg/dl	56 mmol/l	++++
Ketone (KET)	neg.	neg.	neg.
	5 mg/dl	0.5 mmol/l	+
	15 mg/dl	1.5 mmol/l	++
	50 mg/dl	5 mmol/l	+++
	150 mg/dl	15 mmol/l	++++
Urobilinogen (UBG)	norm.	norm.	neg.
	1 mg/dl	17 μ mol/l	+
	4 mg/dl	68 μ mol/l	++
	8 mg/dl	135 μ mol/l	+++
	12 mg/dl	203 μ mol/l	++++
Bilirubin (BIL)	neg.	neg.	neg.
	1 mg/dl	17 μ mol/l	+
	3 mg/dl	50 μ mol/l	++
	6 mg/dl	100 μ mol/l	+++
Erythrocytes (ERY)	neg.	neg.	neg.
	10 / μ l	10 / μ l	+
	25 / μ l	25 / μ l	++
	50 / μ l	50 / μ l	+++
	150 / μ l	150 / μ l	++++
	250 / μ l	250 / μ l	+++++

3. Introduction

3.1.4 Changing Range Remisson Bordes

The boundaries of the reflectance ranges used by **Miditron**[®] Junior *II* to compute and output the test results were derived from rigorous comparative tests carried out by Roche Mannheim with native urine. If required, the factory-set default ranges for **Miditron**[®] Junior *II* may be changed to suit individual laboratories' requirements. Results obtained based on individually modified ranges are flagged with an asterisk * under the "Urinalysis" headline on the patient report.

The ranges for the parameters pH and SG cannot be modified; nor can the thresholds for wavelength changes for pH and ERY.

Operator's Manual outlines how ranges can be selected.



Roche Mannheim can give no guarantee as to the accuracy of results when range boundaries have been changed.

3. Introduction

3.2 System Specification

Dimensions:	Height:	195 mm
	Width:	349 mm
	Depth:	470 mm
Weight:		7.45 kg
Interfaces:		3 serial RS 232 C interfaces (host/PC, barcode reader, external printer)
Power Supply:		External Universal Power Supply Model No. 78-095-0300 with integral ON/OFF switch
	Input:	110 V - 240 V; 50-60 Hz; 0.4-0.2 A
	Output:	5 V 2.0 A 12 V 2.0 A
Power Consumption:	Operation:	30 W
	Standby:	15 W
System Description:	Type:	reflectance photometer
	Light source:	LED's (light emitting diodes)
	Wavelengths:	557 nm, 620 nm (the 656 nm LED is for future options)
	Measuring head:	1 measuring head with 3 LED's
	Work flow:	approx. 36 seconds (Normal Mode) approx. 20 seconds (Accelerated Mode) approx. 12 seconds (Fast Mode)
	Incubation time:	60 seconds
	Printer:	Seiko thermal line printer
	Display:	liquid crystal display, 1 line, 16 characters
Environmental conditions:		
	Operating	Non-Operating
Temperature:	+15°C - +34°C	-20°C - +60°C
Relative humidity:	20 % 80 %	20 % 95 %
Optimum operating conditions:	Opt. Temperature:	+22°C - +26°C
	Opt. Rel. Humidity:	30 % 60 %

3. Introduction

3.3 Service Concept

3.3.1 Service level

From the early stage of development, **Miditron® Junior II** was designed for simple error detection and easy exchangeability of modules. This gives the service workshops the possibility of a fast and easy repair of the instrument on service level A (module level). No big stock or expensive equipment is necessary and service technicians are easier to train. Also, a permanent technical improvement in layout and economic production.

SMD-technology increases reliability on better economical basis in production. Repair costs often do not relate to production costs for new parts with the latest improvement. This cuts the number of repairable parts.

On repairable modules the quality and function is always provided by the manufacturer according to the latest technology. This keeps **Miditron® Junior II** always on the highest quality level.

The exchange price for modules will be kept on a low level to guarantee repairs, on economical basis.

3.3.2 Handling of warranty and repairs

Warranty period for instruments and spare parts

The warranty period for instruments is **16 months** starting with the date of shipment ex works Mannheim/ Federal Republic of Germany or **12 months** starting with the date of the first installation, whichever period is shorter.

The warranty period for spare parts is **6 months** from installation date of the part, however not longer than 24 months after having delivered ex works Mannheim/ Federal Republic of Germany.

Hint:

In case the instrument has a remaining warranty period of more than 6 months, the parts remain under warranty until the warranty period of the instrument expires.

3. Introduction

Handling of warranty claims

The warranty claim has to be handled via Return Authorization procedure or accepted equivalent. Please answer all the questions on the RA form with the greatest care.

Especially a **detailed fault description** is needed or the warranty claim will not be accepted by the manufacturer. Complete instruments are **not accepted** unless this has been agreed with the service department of the relevant product group responsible at RD GmbH.

Important information:

- Only parts marked with „**A**“ in the price list are generally accepted under warranty.
- Only return those parts marked with „**R**“ in the spare parts price list.
- Warranty claim for „**R**“ parts will be accepted, if the part was returned to Mannheim.
- All defective parts (**non-“R”** and „**A**“ parts) should be kept on stock for a period of 7 months. In case the manufacturer needs the part for investigation it will be requested from Mannheim.
- All parts returned to Mannheim and not requested by Mannheim will be send back at the expense of the countries.
- The RA claim for warranty has to be in Mannheim no later than 8 weeks after the **problem date**.

Exclusion of warranty

The aforementioned warranties do not apply in case of improper use, handling, transportation or storage, faulty installation, repair or maintenance, chemical influence or contamination as well as damages resulting from that, failure to follow operating instructions, alterations or modifications of instruments or parts thereof not authorized or recommended by RD GmbH and resulting damages, normal wear and tear and in case of other circumstances beyond the control of RD GmbH.

3. Introduction

Handling of repairs

As a general rule, all instrument repairs should be carried out by authorized and trained personnel only.

Repair of parts marked with „R“

Parts which are economically worth repairing are marked with „R“ in the spare parts price list. New and repaired parts could be recognized by different material numbers (language version).

(e.g. new part: 1234567-**001**, repaired part: 1234567-**984**)

Repaired parts should be ordered together with new parts via the order processing department in Mannheim (OU-VDG). Parallel to the ordering process of a repaired part, the defective part should be returned together with the filled RA form (giving full details of the defect and marked choice box with **repair**) to Logistic Instruments (Goods Receipt) in MA-Wohlgelegen (LI-LV).

Repair of instruments

Complete instruments are **not accepted** for replacement or repair unless this has been agreed with the product group responsible at RD GmbH.

Before replacement or repair can take place, the validity of the request must be examined and the question of costs must be settled in a written agreement with RD GmbH.

Terms of delivery

Shipments to the countries with the routine truck are **c.i.f./** shipments outside this procedure are **ex works Mannheim** .

Emergency shipments require additional costs to be charged.

Handling of costs

“Repaired”-parts (Material-No. 1234567-984) are shipped at a repair price. In case the defective parts are not returned within 3 or 8 weeks for european or oversea countries after ordering the repaired part, the countries will be charged later on with the difference to the new price.

3. Introduction

After the receipt of a warranty request for "A"-parts, RD-G will credit 100 % of the currently effective ex MA price.

In case the manufacturer does not accept the warranty request, the countries will be charged later on with the R-price for R-parts and the new price for non R-parts.

RA form

Return Authorization

Please answer all the questions on the RA form with the greatest care and sign the form.

- Country code
- Problem date
- Type of instrument
- Serial no. of the instrument
- Installation date of instrument
- Defective instrument or spare part
- Part number and material number of the spare part
- Old / new serial no.
- Fault description
- Alarm code
- Service / workshop report no.

In case of instrument out of warranty

- Installation date of spare part

All returned parts should be individually labeled with the corresponding RA no. and shipped together with the completed RA form to:

Roche Diagnostic Mannheim GmbH
Logistic Instruments
RA Management
Friedrich Ebert Str. 100
D - 68167 Mannheim
Germany

3. Introduction

RA form

In the following please find important hints on how to fill in the RA-Form correctly.

ROCHE DIAGNOSTICS MANNHEIM GmbH

Friedrich-Ebert-Strasse 100
D-68167 Mannheim
Germany

Telefon: +49 (621) 759 81 84
Fax : +49 (621) 759 80 93

Return Authorization

No.:
Country code:
Date:
Instrument:
Serial No.:
Installation date:
Spare Part:

Customer:

Address:

(will be filled in by RD)

Part No.:	Qty.:	Part Name:	Repair	Comments
Mat.-No.:			Warranty	
Installation date of Spare Part:			Warranty Repair	
OLD serial No.:			Modification	
NEW serial No.:			Replacement	

Fault Description:

Alarm Code:

Service Report No.:

Workshop Report No.:

Place:

Date:

Signature:

Remarks (will be filled in by RD)

NOS

Credit

FC

RD

4. Installation

4.1 Checking for Damage in Transit

Miditron® Junior *II* is shipped in one package. Please contact the supplier or carrier immediately regarding any damage that may have occurred in transit.

4.2 Unpacking

Unpack the **Miditron**® Junior *II* accessories and check that all are present:

- Operator's Manual
- Transport Arm
- Universal Power Adapter with Connecting Cable
- Printer Paper (5 Rolls)
- Power Cord

4.3 Proper Setting

Set up **Miditron**® Junior *II* on a firm and straight surface. Do not expose the analyzer to direct sunlight or to any other direct light source.

4.4 Setting Up



Do not start the analyzer immediately if it has been subject to an abrupt change in temperature or humidity.



Fig. 31

1. Check that the strip receiving tray / waste tray is correctly positioned in its holder.
2. Attach the transport arm. Grasp the handle end and, while holding it at an angle of 45° from the vertical, insert it as far as it will go along the visible guide, then push down so it snaps into position (Fig. 31).

4. Installation



Fig. 32



Fig. 33

3. Plug one end of the power connector cable into the power socket at the rear of the instrument and the other end into the AC power adapter (Fig. 32). Plug the AC power cord first into the AC power adapter and then into an appropriate AC wall socket.
4. When the AC power adapter is switched on (Fig. 33), **Miditron**® Junior II automatically runs a self-check. The message "Empty Waste Tray" is then displayed. This message is displayed whenever the analyzer has been left switched off or in Standby Mode overnight. Press **<Start>** to cancel the "Empty Waste Tray" message. The analyzer will display "READY - <START>" or "Please Calibrate".
5. If "Please Calibrate" is displayed, press **<Start>**. This will allow you to bypass calibration at this point if you wish to change the user interface language. (The default language setting is English.)
6. Press **<Paging>** until "Setup" is displayed. Press **<Set>** until the desired language appears in the display, then **<Enter>** to confirm your selection. Pressing **<Start>** closes the setup routine and returns you to "READY - <START>" or "Please Calibrate".
7. Insert the roll of printer paper as shown in Figs 34 to 37. (refer to Section 4.5).
8. You may then calibrate the analyzer (refer to Section 6).

4. Installation

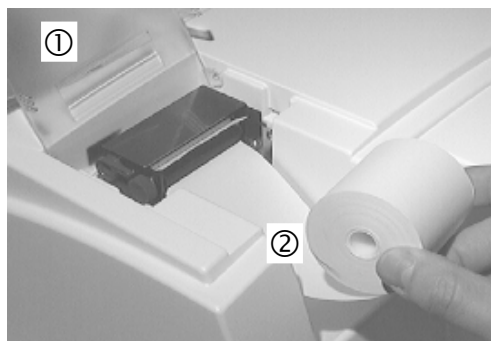

Fig. 34

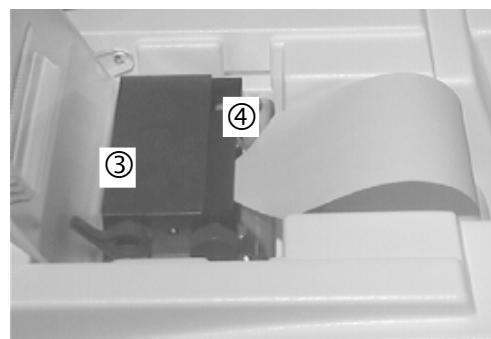

Fig. 35

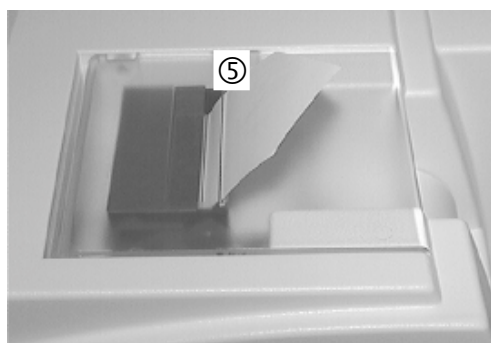

Fig. 36

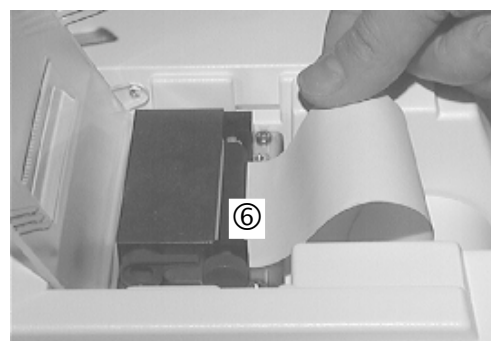

Fig. 37

4.5 Inserting Printer Paper

The printer paper (thermal paper) is heat-sensitive and must be kept away from direct sunlight and high temperatures. Check that there is sufficient printer paper in the printer paper compartment. To insert a new roll of printer paper, follow one of the two methods below:

Method 1:

1. Open the printer cover ① (Fig. 34).
2. Remove the old core and any remaining paper ② (Fig. 34).
3. Place a new roll of paper in the printer paper compartment (**with the end of the paper pointing downwards and towards the printer**) ② (Fig. 34).
4. Lift the lever on the printer ③ (Fig. 35).
5. Cut off the end of the paper at an angle and insert it into the paper slot on the printer ④ (Fig. 35).
6. Pull the paper through the printer and lower the lever ③ (Fig. 35).
7. Feed the paper through the slot in the printer cover and then close the printer cover ⑤ (Fig. 36).
8. Press <Line Feed> to advance the paper.

Method 2:

1. Open the printer cover ① (Fig. 34).
2. Remove the old core and any remaining paper ② (Fig. 34).
3. Place a new roll of paper in the printer paper compartment (**with the end of the paper pointing downwards and towards the printer**) ② (Fig. 34).
4. Cut off the end of the paper square and insert it into the paper slot on the printer ⑥ (Fig. 37).
5. Press <Line Feed> to advance the paper.
6. Feed the paper through the slot in the printer cover and then close the printer cover ⑤ (Fig. 36).

5. Calibration

Miditron® Junior II is factory-calibrated before shipment. The analyzer must be calibrated again before being used for the first time, and then every 14 days. The message "Please Calibrate" will appear in the display whenever the 14-day period has expired.

Calibration is a procedure in which allowance is made for changes in the optical system by reference to an internal compensation pad. If there have been marked changes, caused for instance by soiling of the reference pad or because of low-level light output from a defective LED, an error message is printed out.

Control-Test M calibration strips (Catalogue Number 1 379 194) are standardized grey plastic strips that have constant, defined reflectance characteristics. Calibration strips should not be removed from their container until shortly before use, and should be used once only. Do not touch the elevated grey areas on the strip (see the package insert for more details). Before calibrating, ensure that the transport arm and strip receiving tray / waste tray are clean and dry.

To calibrate, proceed as follows:

Press **<Calibrate>** when you see displayed:

READY - <START>

"The analyzer is ready to measure in Normal mode"

ACC MODE <START>

"The analyzer is ready to measure in Accelerated mode"

FAST MODE<START>

"The analyzer is ready to measure in Fast mode"

Please Calibrate

"The analyzer needs calibrating"

Insert Cal Strip

"Insert calibration strip"

Press <Calibr.>

"Press the Calibrate key"

Calibrating

"Calibration being carried out"

Note:

The "Please Calibrate" message can be bypassed by pressing **<Start>**. In this case, a message will be printed on the patient report.

Two messages will appear alternately in the display: Place the Control-Test M calibration strip in the centre of the strip receiving tray.

Press **<Calibrate>** again. The calibration strip is transported into the analyzer and you see the following displayed:

After about 60 seconds, a printout will occur as long as the printer has not been disabled in the Setup menu.

5. Calibration

```
SW.Vers.  1  1.00
22.01.1998  9:21
Calibration o.k.
      557      620      657
0 64.50  63.60  63.20
1 64.49  63.76  63.11
2 64.40  63.73  64.56
3 64.44  63.82  63.48
4 64.44  63.70  63.39
5 64.32  63.76  63.37
6 64.05  63.50  63.34
7 64.40  63.67  63.26
8 64.55  63.64  63.22
9 64.17  63.70  63.04
10 64.55  63.67  63.28
11 64.35  63.71  63.43
```

Calibration successful:
Printout of reflectance
values in % R.

```
SW.Vers.  1  1.00
22.01.1998  9:21
Cal. Err.   ##
```

Calibration unsuccessful:
Recalibration necessary.

The printout quotes the current software version number, the date and time of calibration, and the positions of the individual test pads on the calibration strip, together with the measured reflectances in % R at the respective wavelengths. Position 0 is the internal reference pad.

If, after several repeat calibrations, you still receive the message "Recalibrate !", please refer to Section 8 "Troubleshooting". During the calibration procedure, the values read from the calibration strip are compared with the stored calibration values. The calibration procedure is as follows:

5. Calibration

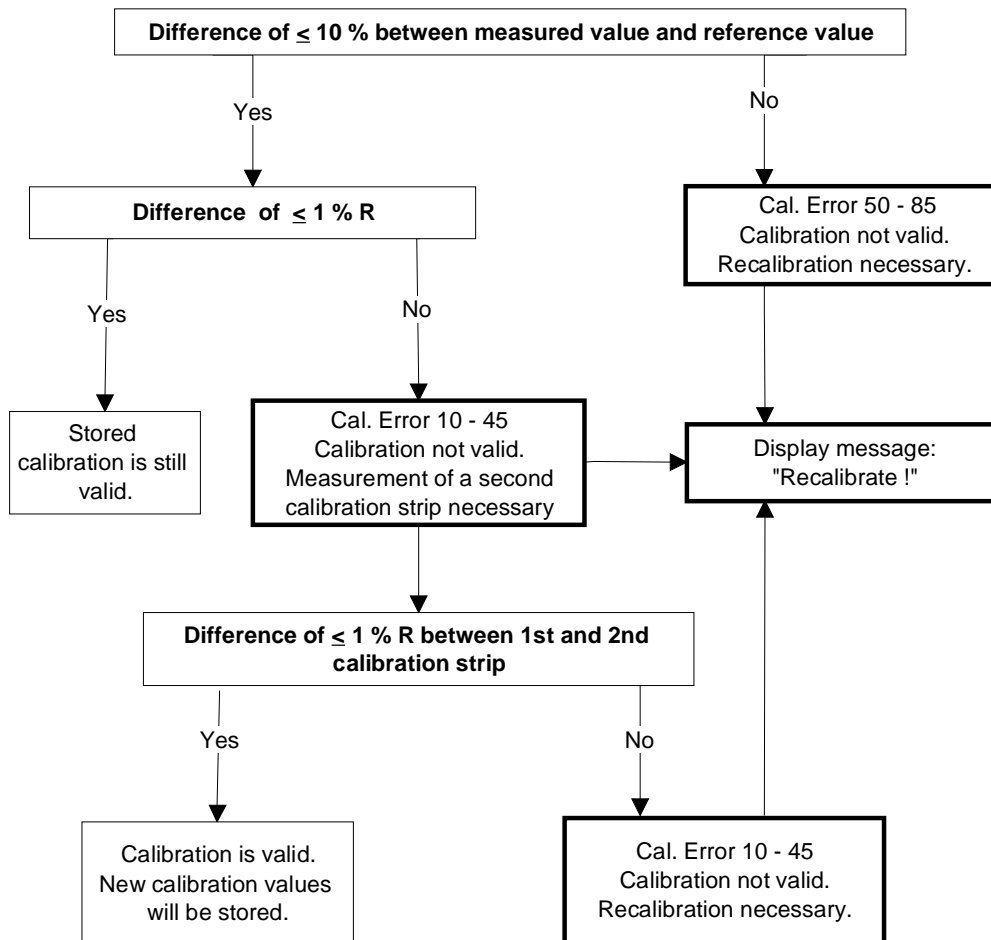

Miditron® Junior II is ready to read as long as there are valid calibration values stored in the analyzer. Calibration every 2 weeks is recommended. If calibration cannot be carried out for any reason, e.g. because there are no Control-Test M calibration strips available, you can bypass the calibration procedure and continue reading by pressing **<Start>** at the "Please Calibrate !" prompt. **Miditron® Junior II** then uses the stored calibration values to carry out further readings.

Note: In this case, "Calibration is necessary" will be printed on the results report.



Roche Mannheim can give no guarantee as to the accuracy of results if the analyzer has not been calibrated.

6. Operation

6.1 Overview

Miditron® Junior II is extremely easy to use. For normal, routine reading of test strips (Normal Mode) simply press **<Start>** to begin reading when you see "READY - <START>".

The user is guided by display messages and the status LED. The status LED appears in one of three states:

- Red = Read display messages,
- Flashing green = Dip a test strip,
- Green = Insert the test strip.

There is also a choice of three operating modes (further details see Operators' Manual):

- Normal Mode
- Accelerated Mode
- Fast Mode



Fig. 60

When dipping a test strip in the sample, always ensure that all of the test pads are completely covered. Place the test strip, with its test pads facing upwards, to the right of the "NO STRIP" warning and between the two elevations along the front edge of the strip receiving tray. The far end of the test strip must be resting on the inner lip at the rear of the tray (Fig. 60).

Miditron® Junior II automatically terminates the series when no further strip is inserted.

You can change between the three operating modes by making the appropriate selection in the Working Mode menu (see Operators' Manual).

Miditron® Junior II automatically assigns consecutive sequence numbers to samples. Numbering automatically starts with 1:

- a) whenever the date has changed (also, the display reads "Empty Waste Tray"), and
- b) following erasure of the results memory.

The waste container integrated into the strip receiving tray can hold up to 75 used test strips. When the container needs emptying, the message "Empty Waste Tray" is displayed. The same message also appears when you press **<Start>** at the beginning of each day. Should the container already be empty, you can bypass the message by pressing **<Start>** again and then proceed with measurements.

The results memory can hold up to 150 results.

6. Operation

If the analyzer has not been used for more than 10 minutes, it automatically enters Standby Mode. The display blanks out and the status LED is red. When you press any function key (except <Line Feed>), the analyzer performs a self-check and returns to "READY - <START>" , "ACC MODE <START>" or "FAST MODE <START>", depending in which mode was selected most recently.

6.2 Normal Mode

In **Normal Mode** the display reads "READY - <START>". Press <Start>, dip a test strip and then insert it in the analyzer. You can repeat this procedure every 36 seconds. The sample throughput is about 100 test strips per hour. Before a test strip is read, you can enter the colour and/or clarity of the sample, in which case "Color Manual" and/or "Clarity On" must be selected in the Setup menu. In addition, the Patient ID may be entered with the aid of a barcode reader or through the numeric keypad.

6.3 Accelerated Mode

In **Accelerated Mode** (a batch mode for processing series of samples) the display reads "ACC MODE <START>". After you have pressed <Start>, you may dip and insert a test strip, when prompted, into the analyzer every 20 seconds. The sample throughput is about 180 tests per hour. In Accelerated Mode, the colour and/or clarity of a sample may be entered before the test strip is read, in which case "Color Manual" and/or "Clarity On" must be selected in the Setup menu. In addition, the Patient ID may be entered with the aid of a barcode reader or through the numeric keypad. In Accelerated Mode, there are up to 3 test strips incubating outside the analyzer.

6.4 Fast Mode

In **Fast Mode** (a batch mode for processing series of samples) the display reads "FAST MODE <START>". After you have pressed <Start>, you may dip and insert a test strip into the analyzer every 12 seconds. The theoretical sample throughput is 300 tests per hour. In Fast Mode, there are up to 5 test strips incubating outside the analyzer.

6. Operation

6.5 Principle movement of the Miditron® Junior II

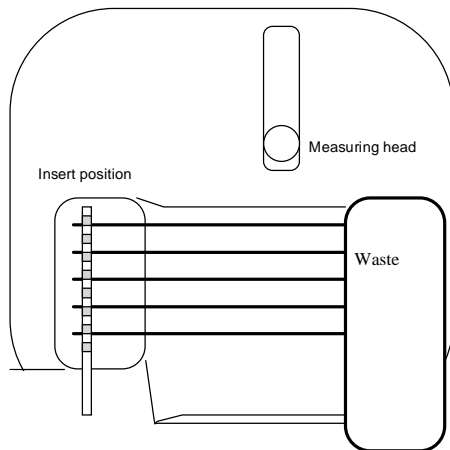

Base-Position

Insert Strip

Transport arm starts moving to the waste position, moves upwards and back. over the waiting strip, turns and moves downwards, takes the strip with.

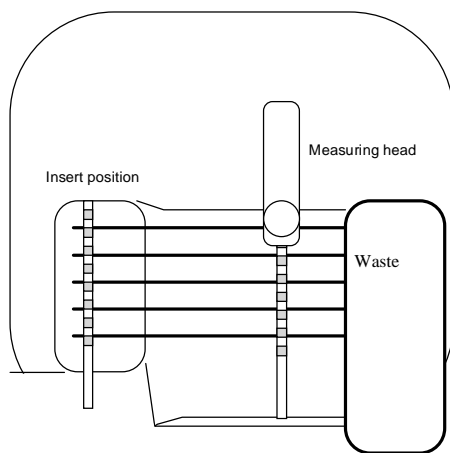
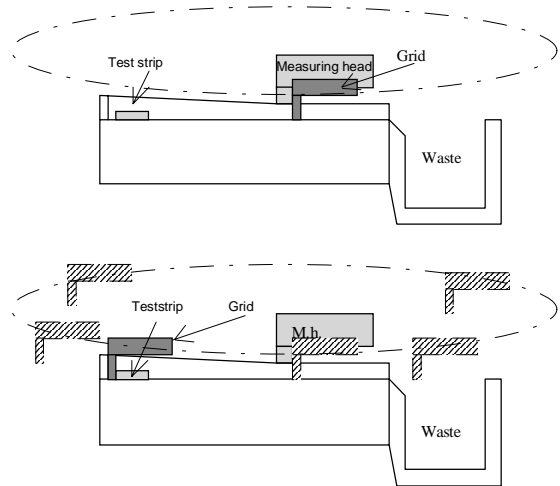

to the measuring position. The next strip can be inserted

Measuring head moves over the strip, field by field, led in y- and z-dimension from the transport arm

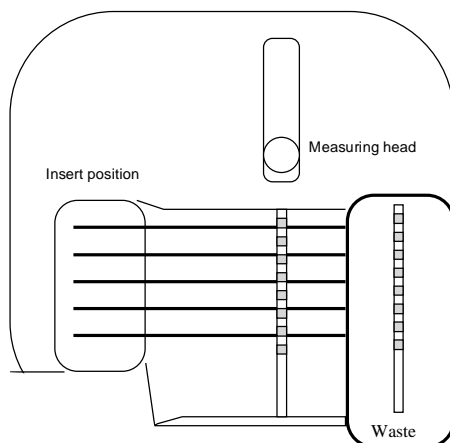
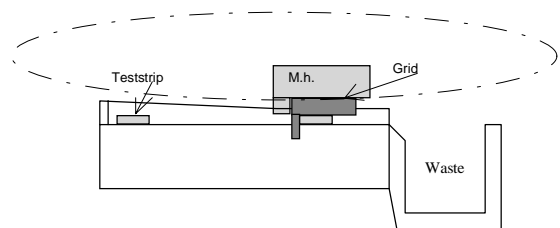

After returning to the parking-position, over the ref.field, the transport arm starts its next run, pushes the measured strip into the waste box and fetches the next strip to be measured.

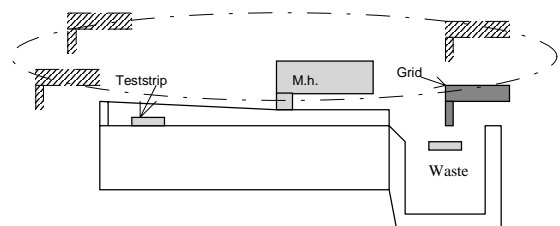

7. Service mode and adjustment

7.1 How to make adjustments

To be able to measure Combur X M strips it will be necessary to position them in such a way over the respective test field that the receiver can register the accessible core zone of the test field.

The strip is pushed by the transport grid in cross direction. This strip takes up a reproducible position in longitudinal direction by means of a control edge on the strip tray.

At the same time the cross movement and the friction of the strip on the tray ensures that the strip runs up against the 2 catch teeth of the grid. The strip is still free heightwise because the double leaf suspension system keeps the transport arm held upwards.

If the measuring head now travels over the transport grid, the suspension presses the transport grid down and clamps the strip in position.

At the same time, one component of the suspension system measuring head ensures that the strip runs along the guiding edge of the grid. In this way we ensure that the cross positioning is within the indexing accuracy of measuring head and grid.

The measuring head is likewise positioned in height directly over the grid. The grid has an appropriate height section to compensate the varying thickness of the different test fields. With its runners the measuring head slides over the height section. In this way the distance of the measuring head to the surface of the test field is determined within the tolerances of the measuring head, grid and test field.

Position in longitudinal direction of the strip:

The drive train of the measuring head has a light barrier as reference. The switching point of the light barrier in the direction of travel on the instrument user TEXT??? side is such that the measuring head with its measuring patch (2.7 mm in diameter) is on the reference field (14 x 14 mm). From this reference position the measuring head is traveled by step motor a specific number of steps to the first test field and from there from test field to test field in a fixed number of steps. Since a long chain of tolerances is given from the light barrier to the middle of the test patch the first number of steps (to the test field) is kept variable and adjusted depending on the actual instrument.

7. Service mode and adjustment

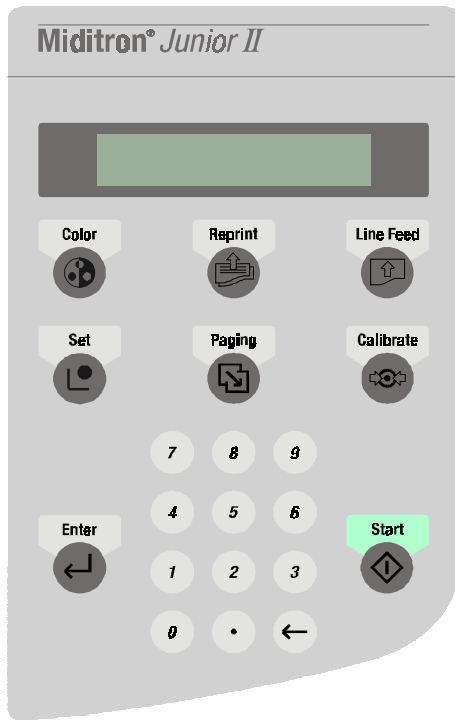

SET=Protocol

"The analyzer is in Service mode"

SET=Protocol

"The analyzer is in Service mode"

Adjustment is made with the help of an optical signal from the measuring head. A special adjustment strip has a bright bar 2 mm in width on a dark background in the test field position 7.

If this test field is now traveled over stepwise and measured, a measurement curve will be produced which will then show a maximum when the measuring head with its optical center is centered over the bright bar. The adjustment program of the **Miditron® Junior II** counts the steps to this maximum and calculates from these the number of steps from the reference position to the center of the first test field. The number of steps is saved as adjustment position.

7.2 General

The adjustment procedure should be undertaken by trained service staff only. It is used to clear unexpected errors and after repair work. No special service tools are necessary although adjustment strips will be used. The strips are available as a spare part with ID 1 704 656.

7.3 Procedure

The service mode can be reached by two different ways:

1) During the self-test after power on:

During the self-test enter numbers **<1,7,0,4>** via the keyboard and confirm by pressing **<Enter>**. The display shows:

Any other or incomplete input stops the process and the instrument changes to normal mode.

2) With connected service computer:

When the display shows **"READY-<START>"** type keywords **<PW 1704>** via terminal program of the computer which is connected to the printer interface. The display shows:

Any other or incomplete input stops the process and the instrument changes to normal mode.

7. Service mode and adjustment

SET=Protocol

"The analyzer is in Service mode"

```
SW.Vers. 1 1.00
29.01.1998 15:01

hours of work: 68:50
cycles: 248
last meas.: 29.01.98
calibration: ok
last cali.: 29.01.98
pga g:107 o: 75 r:134
    557 620 657
 0 64.50 63.60 63.20
 1 64.49 63.76 63.11
 2 64.40 63.73 64.56
 3 64.44 63.82 63.48
 4 64.44 63.70 63.39
 5 64.32 63.76 63.37
 6 64.05 63.50 63.34
 7 64.40 63.67 63.26
 8 64.55 63.64 63.22
 9 64.17 63.70 63.04
10 64.55 63.67 63.28
11 64.35 63.71 63.43

adjust position: 643
results in memory: 0

settings :
English
24 hours
Format: dd:mm:yy
Host/PC No
Int. Printer <1>
Ext. Printer Off
PatID.13-digits
Color Off
Clarity Off
Combur-10M

SG PH LEU NIT PRO GLU
KET UBG BIL ERY
Conv & Arb
Ranges Default
Flag default On
MICRO: No Space
Memory Ignore
Normal Mode
Last 1 result

error statistic :
no errors
```

Service Mode:

This display reading indicates that you are in the Service Mode:

Press **<Paging>** to select the next menu item "Check Keys" or initiate a printout of the status protocol with **<Set>**. The printout will start after approx. 3 seconds.

The following information is shown:

- The current software version of the instrument.
- Current date and time.
- The total number of hours the instrument has already worked.
- The total number of cycles the instrument has already performed.
- The date of the last measurement.
- The result of the last calibration.
- The last calibration date.
- The strength of the LEDs.
- The wavelengths of the LEDs.
- The adjustment values.
- The current adjustment position.
- The number of results in the memory.
- Information about the current instrument settings.
- The most recent error statistics.

7. Service mode and adjustment

SET=Check Keys

"All keys can be checked"

When "Check Keys" is selected the display reads:

Press **<Paging>** to select the next menu item "Check LCD", or initiate the key test by pressing **<Set>**.

To carry out the key test, all keys have to be pressed one after another. The key test routine can be aborted only after all keys have been tested.

SET=Check LCD

"Display test can be performed"

When "Check LCD" is selected the display reads:

Press **<Paging>** to select the next menu item "Delete Data", or initiate the display test with **<Set>**.

During the display test it is possible to display up to six different test patterns by pressing **<Set>**. Press **<Paging>** to select the next menu item.

SET=Delete Data

"All data can be reset to their default settings"

When "Delete Data" is selected the display reads:

Press **<Paging>** to select the next menu item "INI-Download", or reset all instrument settings to the factory default settings by pressing **<Set>**.

SET=INI-Download

"The download of an INI-file can be started"

When "INI-Download" is selected the display reads:

Press **<Paging>** to select the next menu item "SET=Save INI", or press **<Set>** to initiate the download of an INI-file from the connected service PC. All instrument settings are contained in the INI-file. Downloading can be aborted by pressing **<Paging>**.

SET=Save INI

"All instrument settings can be saved"

When "SET=Save INI" is selected the display reads:

Press **<Paging>** to select the next menu item "SET=ADJUST", or press **<Set>** to start the upload of all instrument settings to the connected PC. Uploading can be aborted by pressing **<Paging>**.

SET=ADJUST

"The position of the test field on the adjustment strip can be adjusted"

When "SET=ADJUST" is selected the display reads:

During adjustment, the motor measuring head unit counts the number of steps to the center of the test field of the adjustment strip. The number of steps derived from this is saved as the new step number to reach the test field.

Insert ADJ.STRIP

"Insert first adjustment strip"

Press **<Paging>** to terminate the Service Mode or initiate the adjustment procedure with **<Set>**. The display reads:

7. Service mode and adjustment

Place the first adjustment strip in the middle of the insertion area and initiate the adjustment procedure by pressing **<Start>**.

The adjustment of the first adjustment strip begins. Once adjustment is completed, a report will be printed and sent to the printer interface. If the adjustment was carried out correctly the display reads:

Insert ADJ.STRIP

"Insert second adjustment strip"

Place the second adjustment strip in the middle of the insertion area and initiate the adjustment procedure by pressing **<Start>**.

The adjustment of the second adjustment strip begins. Once adjustment is completed, a report will be printed and sent to the printer interface. If the adjustment was carried out correctly the display reads:

READY <START>

"Analyzer is in the Normal Mode"

After the adjustment has been completed, the Service Mode is terminated and the analyzer returns to the Normal Mode.

7. Service mode and adjustment

Tabelle Service Mode

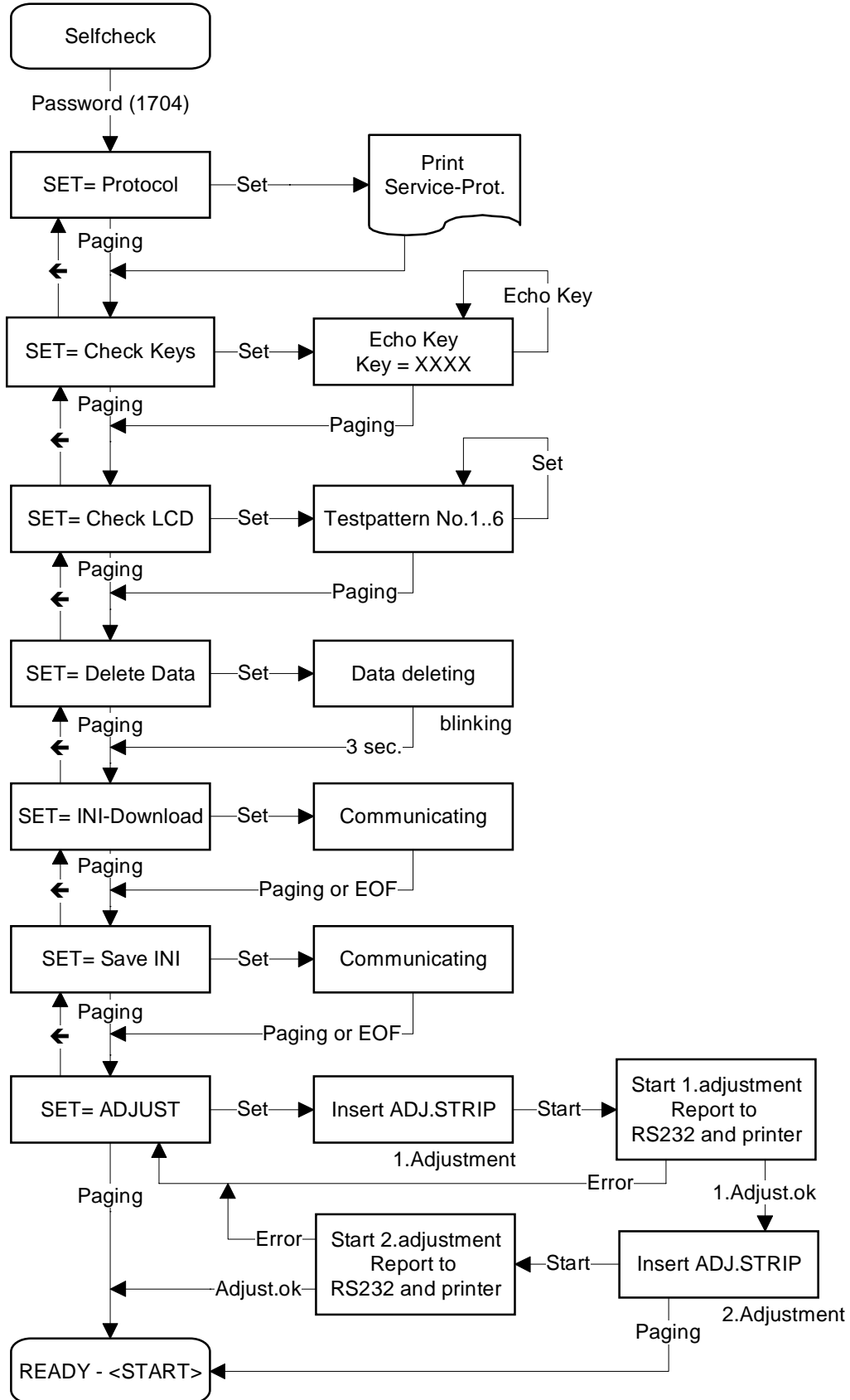

8. Adjustment / Dismantling

Adjustment and dismantling are described in detail:

Chapter 9 (Mechanics)

- 9.1.1 Transport arm
- 9.1.2 Tray
- 9.1.3 Top of housing
- 9.1.4 PCB Main
- 9.1.5 PCB Interface
- 9.1.6 Display
- 9.1.7 Printer
- 9.1.8 Status LED
- 9.1.9 Keyboard
- 9.1.10 PCB Measuring Head
- 9.1.11 LB Measuring Head Home Position
- 9.1.12 LB Home Position
- 9.1.13 Motor Belt Drive Cross Transport
- 9.1.14 Motor Measuring Head Unit
- 9.1.15 Tooth Bar Measuring Head Unit
- 9.1.16 Carrier for Tray
- 9.1.17 Reference Field Carrier
- 9.1.18 Crossbar complete
- 9.1.19 Cross Transport

Chapter 10 (Electronics)

- 10.1 Overview Electronics
- 10.2 Power Supply
- 10.3 Elektronic Moduls
 - 10.3.1 Main Board
 - 10.3.2 Interface Board
 - 10.3.3 Display
 - 10.3.4 Printer
 - 10.3.5 Status LED
 - 10.3.6 Keyboard
 - 10.3.7 Measuring Head PCB
 - 10.3.8 LB Measuring Head Homeposition
 - 10.3.9 LB Home Position
 - 10.3.10 LB Referenzposition
 - 10.3.11 Motor Belt Drive Cross Transport
 - 10.3.12 Motor Measuring Head Unit

9. Mechanics

9.1 Mechanical moduls



Pull power plug before working on the open instrument.

9.1.1 Transport arm

The transport arm (1) is snapped in from diagonally above.

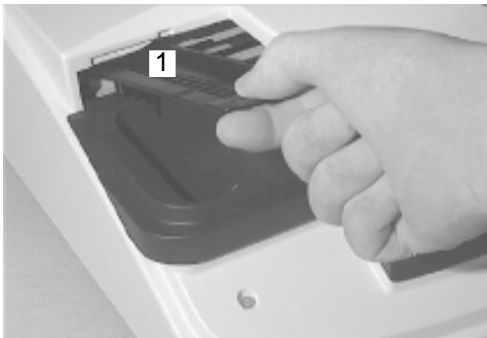

Fig. 1

Exchangeable components:

- Transport arm (1).

Dismantling:

- Pull power plug
- Lift transport arm (1) up until it snaps out
- Remove transport arm (1)

Assembling:

- Insert transport arm (1) from diagonally above and push down until it snaps in.

9.1.2 Tray

The tray (2) is in front of the instrument.



Fig. 12

Exchangeable components:

- Tray including waste container (2).

Dismantling:

- Pull tray (2) forward, out of the instrument

Assembling:

- Push tray (2) from the front into the instrument until it snaps in.

9. Mechanics

9.1.3 Top of housing

The top of housing (3) is connected to the lower casing (33) with 6 screws (4).

Exchangeable components:

- Top of housing (3).

Dismantling:

- Remove transport arm (see chapter 9.1.1)
- Remove tray (see chapter 9.1.2).
- Take out paper roll (5).
- Remove 6 screws (4) of the lower casing (33)
- Remove top of housing (3).

Watch for cable connections between top of housing (3) and PCB Main (9). Plugs or cables could be damaged.

- Loosen 2 cable connection (6) and (7) from the PCB Main (9).
- Carefully, first remove the metal clamp (8) of the flat cable (6).

The metal clamp (8) is hard to remove. Do not pull the cable.

Assembling:

- Make two cable connections (6) and (7) to the PCB Main (9).
- Mount metal clamp (8) to protect flat cable (6).
- Put on top of housing (3) and screw on with six screws (4).

Adjustment:

An adjustment is not necessary.

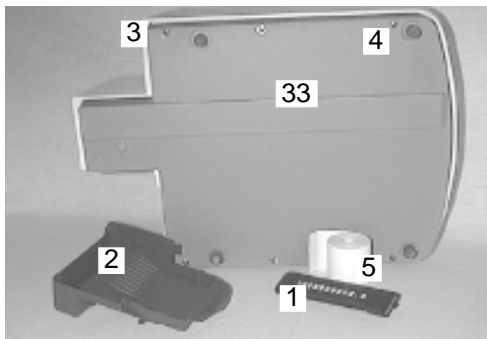

Fig. 14

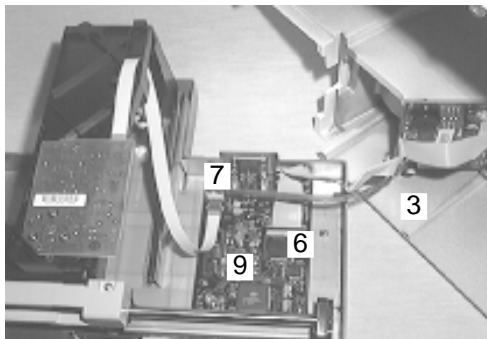

Fig. 16

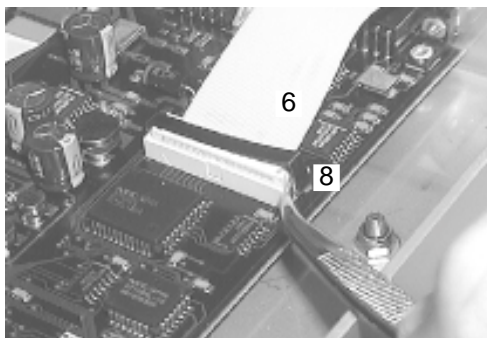

Fig. 17

9. Mechanics

9.1.4 PCB Main

The PCB Main (9) is screwed to the base plate (10) with 4 screws (18).

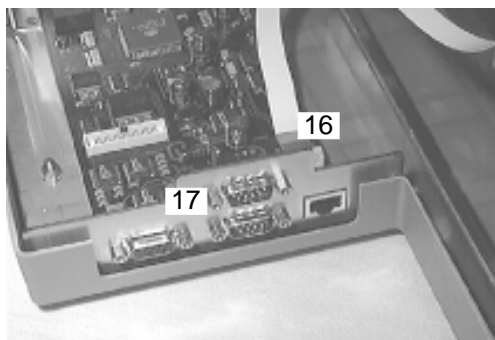

Fig. 20

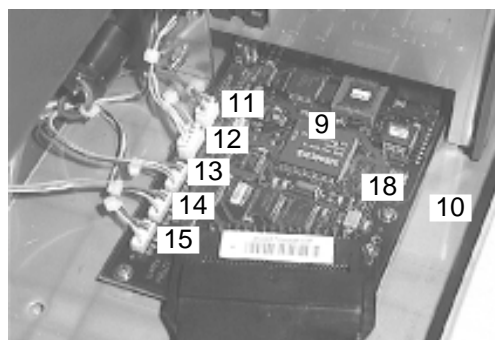

Fig. 19

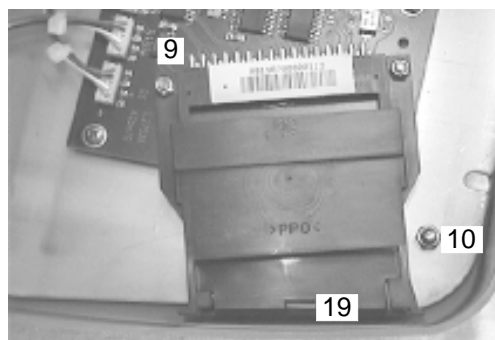

Fig. 21

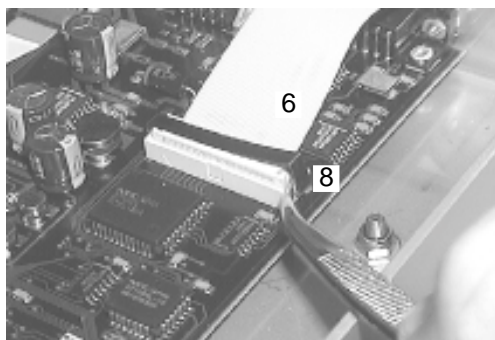

Fig. 17

Exchangeable components:

- PCB Main (9)

Dismantling:

- Remove top of housing (see chapter 9.1.3).
- Remove cable (16) to PCB Measuring Head.
- Remove 6 screws (17) at the interface plugs.
- Remove five remaining plug connections of PCB Main (9).
 - plug (11) to motor belt drive cross transport
 - plug (12) to motor measuring head unit
 - plug (13) to LB reference position
 - plug (14) to LB home position
 - plug (15) to LB measuring head home position
- Remove 4 screws (18) of the PCB Main (9).
- Push PCB Main (9) forward and pull out upwards
- Nose of chip card slot (19) has to be in front of base plate (10) so that PCB Main (9) can be pulled out upwards.

Assembling:

- Insert PCB Main (9).
- Push PCB Main (9) forward.
- Nose of chip card slot (19) has to be under base plate (10).
- Push PCB Main (9) backwards and screw on with 4 screws (18).
- Screw on 6 screws (17) to the interface plugs.
- Connect all plugs and connections.

Be sure to use correct order of plugs to the light barriers.

- Plug (13) to LB reference position
- Plug (14) to LB home position
- Plug (15) to LB measuring head home position
- Put on metal clamp (8) to protect flat cable (6)

Adjustment:

While inserting the PCB Main (9) the nose of the chip card slot (19) has to be under the base plate (10). Another adjustment is not necessary.

9. Mechanics

9.1.5 PCB Interface

The PCB Interface (20) is screwed to the top of housing (3) with 4 screws (21).

Exchangeable components:

- PCB Interface (20).

Dismantling:

- Remove top of housing (see chapter 9.1.3).
- Remove all five plug connections of PCB Interface (20).
 - Plug (22) to keyboard
 - Plug (23) to display
 - Plug (24) to printer
 - Plug (25) to status LED
 - Plug (26) to power supply of PCB Main
 - Plug (27) to connection of PCB Main. This plug needs to be removed from the PCB Main (see chapter 9.1.4).
- Remove 4 screws (21) of the PCB Interface (20).

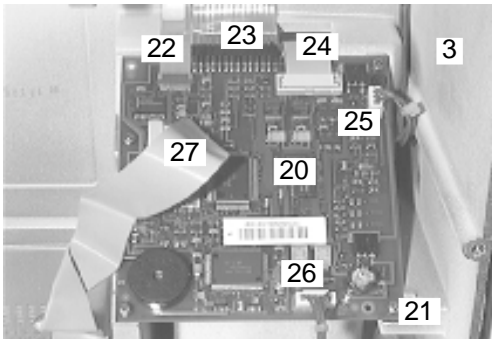

Fig. 23

Assembling:

- Insert PCB Interface (20) and screw on with 4 screws (21).
- Connect all plugs and cable connections.

Adjustment:

An adjustment is not necessary.

9. Mechanics

9.1.6 Display

The display (28) is screwed to the top of housing (3) with 4 screws (29).

Exchangeable components:

- Display

Dismantling:

- Remove top of housing (see chapter 9.1.3)
- Remove plug connection (31) of flat cable to PCB Interface (20).
- Remove 4 screws (29) from the display (28).

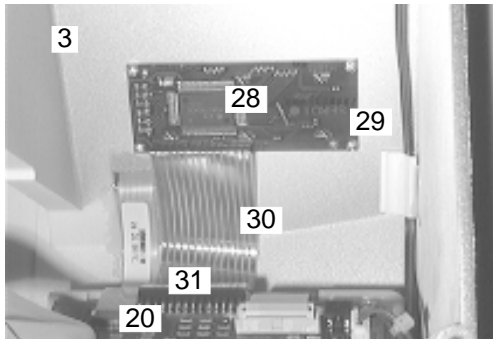

Fig. 24

Assembling:

- Insert display (28) and screw on with 4 screws (29).
Slightly tighten screws (thread in top of housing (3) can be damaged)
- Reconnect plug (31)
- Cable has to touch wall of housing (danger of collision with cross transport)

Adjustment:

An adjustment is not necessary.

9. Mechanics

9.1.7 Printer

The printer (32) is screwed to the top of housing (3) with 4 screws (33).

Exchangeable components:

- printer (32)

Dismantling:

- Remove top of housing (see chapter 9.1.3)
- Remove cable of PCB Interface
- Remove 4 screws (33) from above
- Carefully remove printer. Watch out for cable of printer (cable and plug can be damaged).

Assembling:

- Pull cable (24) through hole of top of housing (3)
- Insert printer (32) and screw on with 4 screws (33)
- Connect cable (24) to PCB Interface (20)

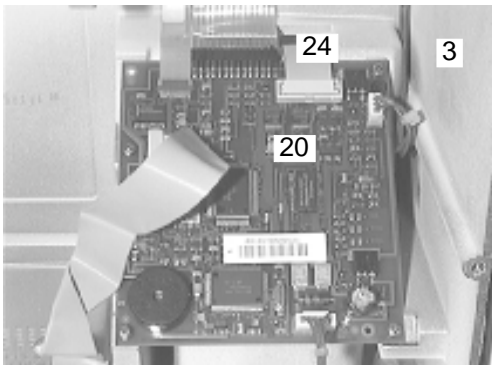

Fig. 23

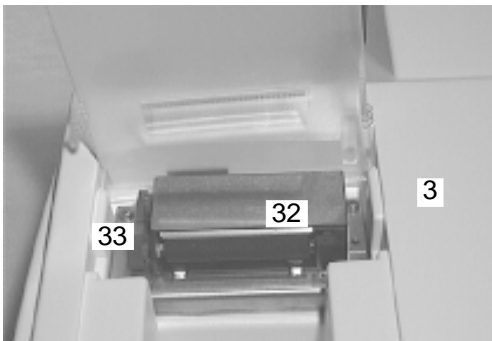

Fig. 26

Adjustment:

An adjustment is not necessary.

9. Mechanics

9.1.8 Status LED

The status LED (35) is glued to top of housing (3).

Exchangeable components:

- Status LED (35).

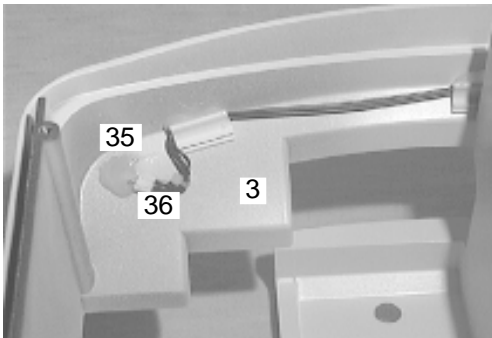

Fig. 27

Dismantling:

- Remove top of housing (see chapter 9.1.3)
- Remove plug (36)
- Remove status LED (35)

Assembling:

- Glue on status LED (35). Use solvent free glue i.e. hot glue
- Connect plug (36) to status LED (35)

Adjustment:

An adjustment is not necessary.

9. Mechanics

9.1.9 Keyboard

The keyboard (37) is glued to the top of housing (3).

Exchangeable components:

- keyboard (37)

Dismantling:

- Remove top of housing (see chapter 9.1.3)
- Remove plug (22) from PCB Interface (20)
- Remove keyboard (37) from top of housing (3)

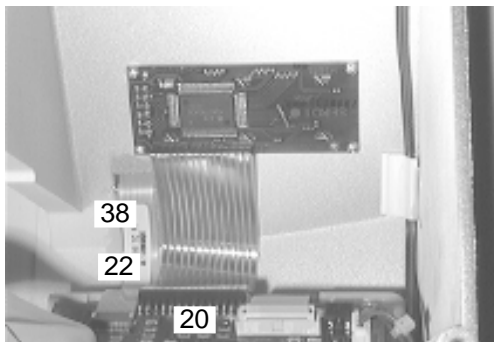

Fig. 24

Assembling:

- Remove glue remains from top of housing (3)
- Pull cable (38) through hole of top of housing (3)
- Remove protection strip of adhesive foil from back of keyboard (37)
- Insert keyboard (37) at the top and flush left (see arrows) and press on.
- Connect cable (38) to PCB Interface (20).
- Glue self-sticking cable (38) to interior of top of housing (3).

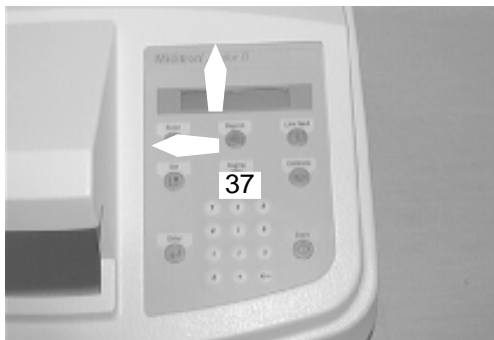

Fig. 28

Adjustment:

An adjustment is not necessary.

9. Mechanics

9.1.10 PCB Measuring Head

The PCB Measuring Head (39) is assembled to the measuring head carrier (40).

Exchangeable components:

- PCB Measuring Head (39)
- cable PCB Measuring Head (41)
- measuring head carrier (40)

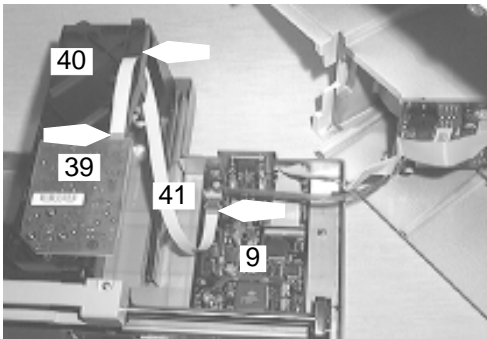

Fig. 16:

Dismantling:

- Remove top of housing (see chapter 9.1.3).
- Remove cable (41) from PCB Main (9).
- Unhook spring of measuring head carrier (40) and remove measuring head carrier (40) upwards.
- Open plastic clamp (43) of measuring head carrier (40).
- Remove PCB Measuring Head (39).
- Remove cable (41) of PCB Measuring Head (39).

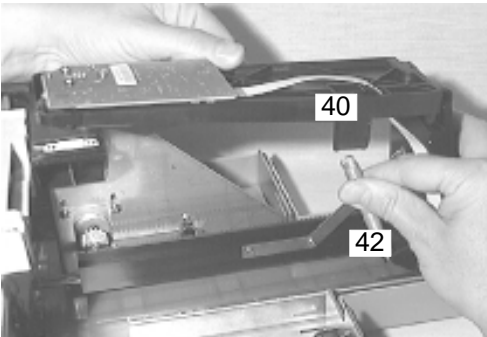

Fig. 29:

Assembling:

- Connect cable (41) to PCB Measuring Head (39). Blue mark (arrow) of cable (41) has to be on top.
- Assemble PCB Measuring Head (39) to measuring head carrier (40). PCB Measuring Head (39) must be in the guide rail (45).
- Close plastic clamp (43).
- Put on measuring head carrier (40) and let it snap in.
- Hook on spring (42).
- Pull cable (41) through hole (arrow) of measuring head carrier (40) and connect to PCB Main (9). Blue mark (arrow) on end of cable (41) has to be on top.

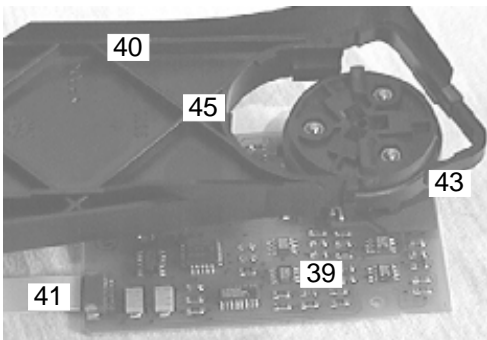

Fig. 6:

Adjustment:

An adjustment is not necessary.

9. Mechanics

9.1.11 Light Barrier Measuring Head Home Position

The LB measuring head home position (46) is screwed to the base plate (10).

Exchangeable components:

- LB measuring head home position (46).

Dismantling:

- Remove top of housing (see chapter 9.1.3)
- Remove plug (15) from PCB Main (9).
- Remove 2 screws (47).
- Pull out LB measuring head home position (46).

Assembling:

- Assemble LB measuring head home position (46).
- Tighten 2 screws (47).
- Connect plug (15) to PCB Main (9).

Adjustment:

An adjustment is not necessary.

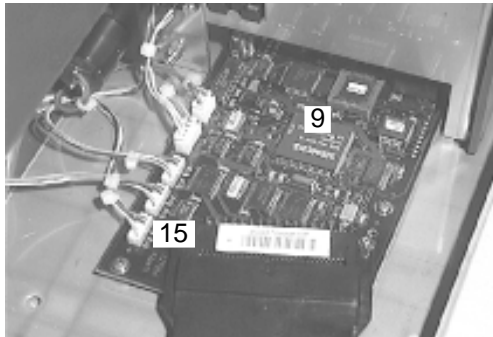

Fig. 19

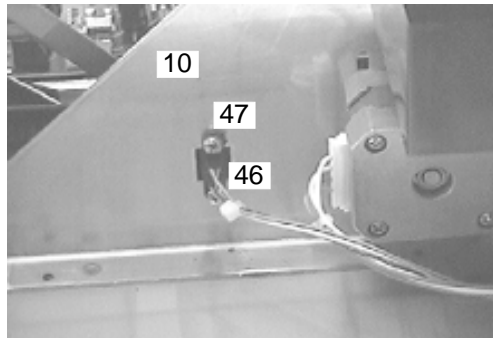

Fig. 9

9. Mechanics

9.1.12 Light Barrier Home Position

The LB home position (48) is screwed to the base plate (10).

Exchangeable components:

- LB home position (48)

Dismantling:

- Remove top of housing (see chapter 9.1.3)
- Remove plug (14) from PCB Main (9).
- Remove 2 screws (49).
- Pull out LB home position (48).

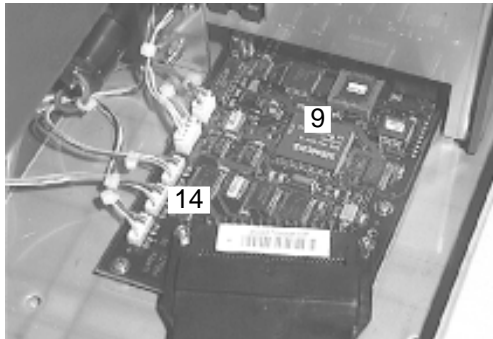

Fig. 19

Assembling:

- Assemble LB home position (48).
- Tighten 2 screws (49).
- Connect plug (14) to PCB Main (9).

Adjustment:

An adjustment is not necessary.

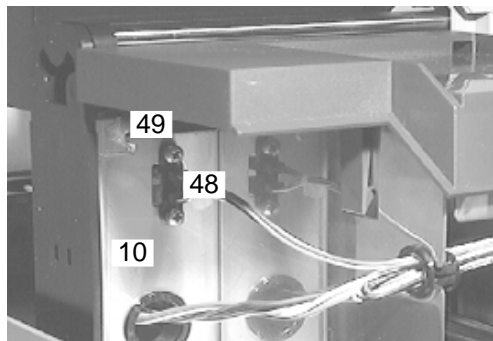

Fig. 13

9. Mechanics

9.1.13 Motor Belt Drive Cross Transport

The motor belt drive cross transport (50) is screwed to the base plate (10).

Exchangeable components:

- Motor belt drive cross transport (50) including plate (53) and LB reference position (52).

Dismantling:

- Remove top of housing (see chapter 9.1.3)
- Remove plugs (11) and (13) from PCB Main (9).
- Remove three nuts (51) of motor belt drive cross transport (50).
- Take out motor belt drive cross transport (50).

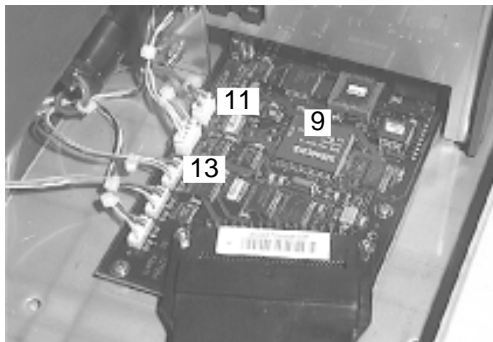

Fig. 19

Assembling:

- Assemble motor belt drive cross transport (50). Use left recess (arrow) of the plate (53) motor belt drive cross transport (50) as mark for the assembling position.
- Tighten 3 nuts (51).
- Connect plugs (11) and (13) to PCB Main (9).

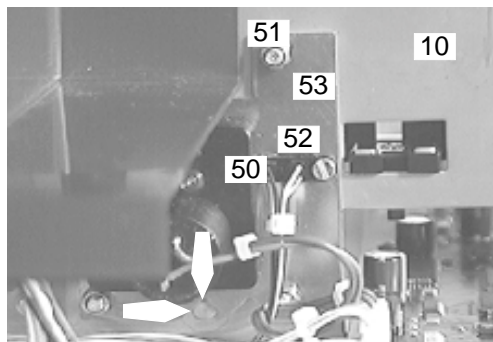

Fig. 10

Adjustment:

An adjustment is not necessary.

9. Mechanics

9.1.14 Motor Measuring Head Unit

The motor measuring head unit (54) is screwed to the base plate (10).

Exchangeable components:

- motor measuring head unit (54).

Dismantling:

- Remove top of housing (see chapter 9.1.3).
- Remove plug (12) of PCB Main (9).
- Remove 2 screws (55).
- Remove motor measuring head unit (54).

Assembling:

- Push tooth bar measuring head unit (56) way to the rear.
- Assemble motor measuring head unit (54) and put on tooth bar with its net weight.
- Tighten 2 screws (55). The motor must be in a diagonal position, in front (a) deeper than in the back (b).
- Connect plug (12) to PCB Main (9).

Adjustment:

The motor has to be adjusted in a slightly diagonal way, as described under assembling.

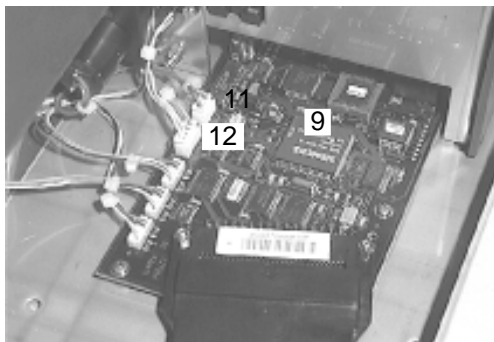

Fig. 19

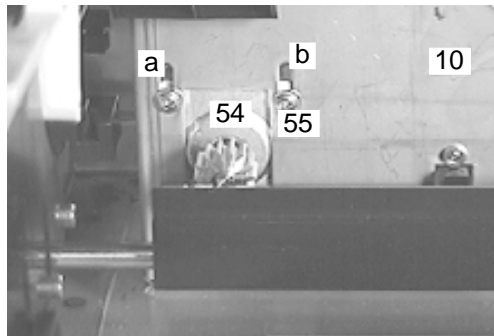

Fig. 4

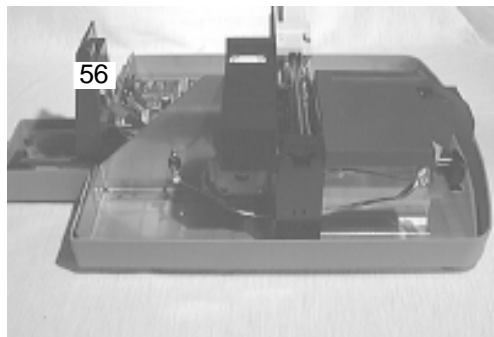

Fig. 7

9. Mechanics

9.1.15 Tooth Bar Measuring Head Unit

The tooth bar measuring head unit (56) is assembled to the base plate (10).

Exchangeable components:

- tooth bar measuring head unit (56).

Dismantling:

- Remove top of housing (see chapter 9.1.3).
 - Unhook spring (42) of measuring head carrier (40).
 - Remove measuring head carrier (40) upwards.
 - Remove 2 screws (55).
 - Remove motor measuring head unit (54).
 - Remove two plastic clamps (57).
 - Pull out bar (58).
 - Remove tooth bar measuring head carrier (56) upwards. Do not damage LB measuring head home position (46).
- Re-use metall ball (59) (high-grade steel, diameter 10 mm) in case of changing the tooth bar measuring head unit (56).**

Assembling:

- Assemble tooth bar measuring head unit (56). Do not damage LB measuring head home position (46).
- Insert bar (58).
- Tighten 2 plastic clamps (57).
- Push measuring head unit (56) way to the rear.
- Insert measuring head unit (54) and lay on tooth bar with its net weight.
- Tighten 2 screws (55). The motor must be in a diagonal position, in front (a) deeper than in the back (b).
- Put on measuring head carrier (40) and let it snap in.
- Hook in spring (42).

Adjustment:

The motor has be adjusted in a slightly diagonal way, as described under assembling.

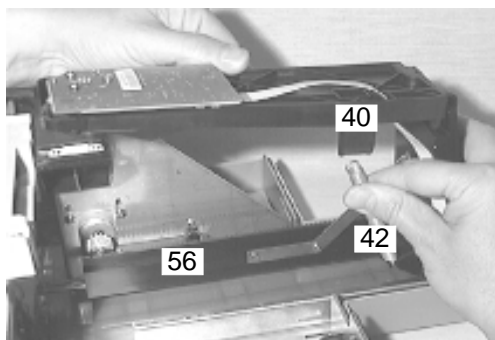

Fig. 29

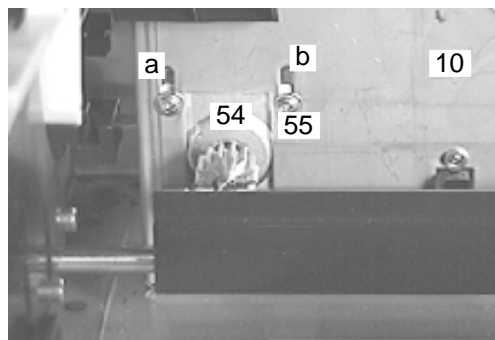

Fig. 4

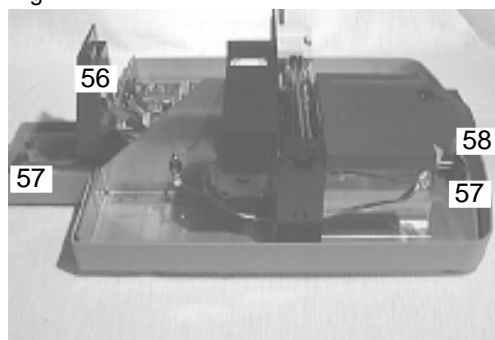

Fig. 7

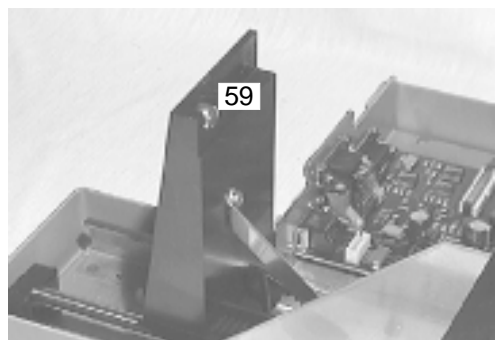

Fig. 8

9. Mechanics

9.1.16 Carrier for tray

The carrier for tray (60) is plugged to the base plate (10).

Exchangeable components:

- Carrier for tray (60).

Dismantling:

- Remove top of housing (see chapter 9.1.3).
- Loosen right joint on the bottom of the carrier for tray (60).
- Hold away 2 plastic clamps on the bottom of the carrier for tray (60).
- Remove carrier for tray (60) upwards.

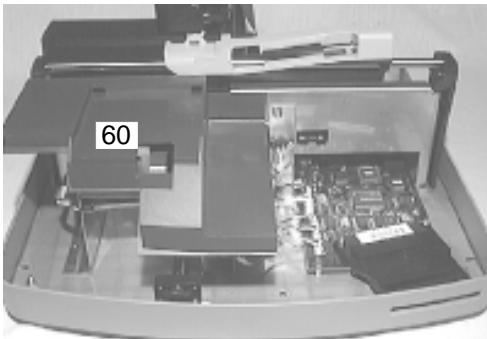

Fig. 2

Assembling:

- Put carrier for tray (60) on base plate (10).
- The 2 plastic springs on the bottom of the carrier for tray (60) have to snap in.
- Re-glue right plastic spring to the bottom of the carrier for tray (60). Use solvent free glue i.e. hot glue.

Adjustment:

An adjustment is not necessary.

9. Mechanics

9.1.17 Reference Field Carrier

The reference field carrier (61) is plugged to the base plate (10).

Exchangeable components:

- Reference field carrier (61).

Dismantling:

- Remove top of housing (see chapter 9.1.3).
- Hold away plastic spring on the inside of the reference field carrier (61).
- Remove reference field carrier (61) upwards.

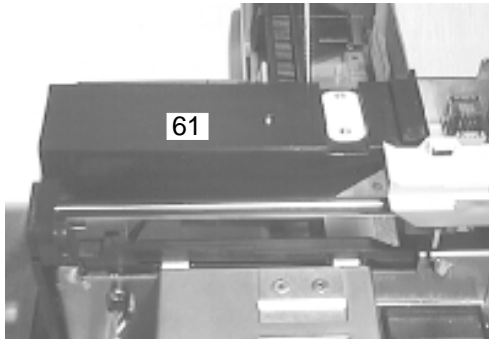

Fig. 3

Assembling:

- Put reference field carrier (61) on base plate (10).
- Plastic spring on the inside of the reference field carrier (61) has to snap in.

Adjustment:

An adjustment is not necessary.

9. Mechanics

9.1.18 Crossbar complete

The crossbar complete (62) are laterally plugged to the base plate (10).

Exchangeable components:

- Crossbar complete (62) including holding clamps.

Dismantling:

- Remove top of housing (see chapter 9.1.3).
- Remove carrier for tray (see chapter 9.1.16).
- Remove holding clamps (63).
- Hold away crossbar on top and to the outside.
- Remove crossbar (62) upwards.

Assembling:

- Assemble crossbar (62) laterally from above to the base plate (10).
- Crossbar must laterally snap in to the base plate.
- Put on holding clamps.

Adjustment:

An adjustment is not necessary.

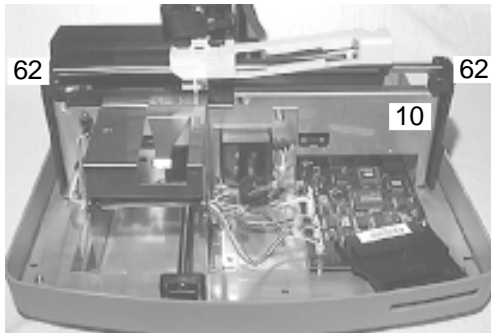

Fig. 5

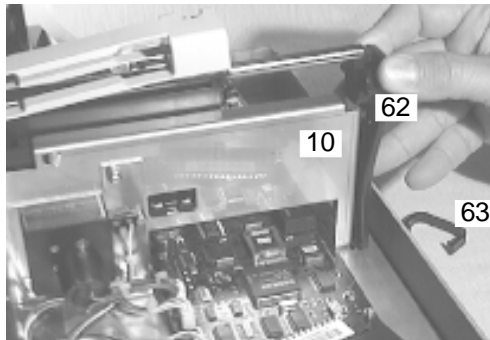

Fig. 11

9. Mechanics

9.1.19 Cross Transport

The cross transport consists of the sled (64) and the guiding (67).

Exchangeable components:

- Sled (64)
- Guiding (67).

Dismantling:

- Remove top of housing (see chapter 9.1.3)
- Remove carrier for tray (see chapter 9.1.16).
- Remove holding clamps (63).
- Pull out bar (65).
- Remove sled (64).
- Screw must not be loosened or tightened. Movability of sled (64) needs to be guaranteed.**
- Loosen 3 joints on the clamps (66) of the guidance (67).
- Remove guidance (67).

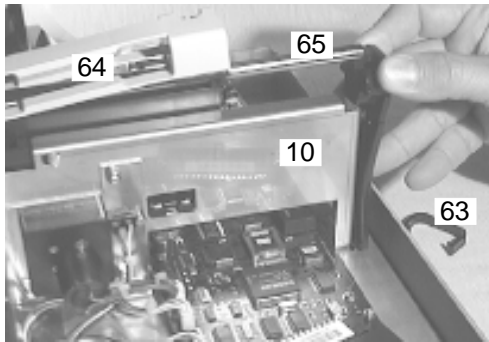

Fig. 11

Assembling:

- Assemble guidance (67).
- Glue 3 clamps (66) of the guidance to the base plate (10). Use solvent free glue i.e. hot glue.
- Put bar (65) onto the left side of the crossbar.
- Slide in sled (64).
- Close holding clamps (63).

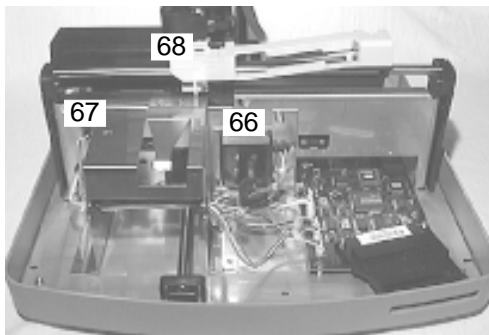

Fig. 5

Adjustment:

- An adjustment is not necessary.

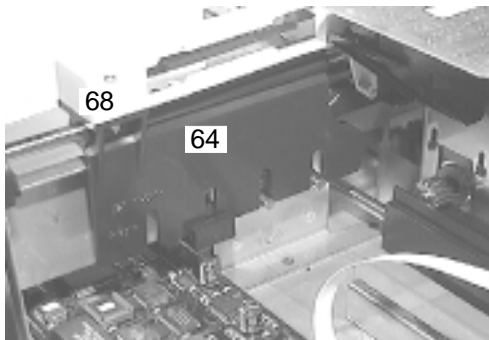

Fig. 18

10. Electronics

10.1 Overview Electronics

Circuit diagram:

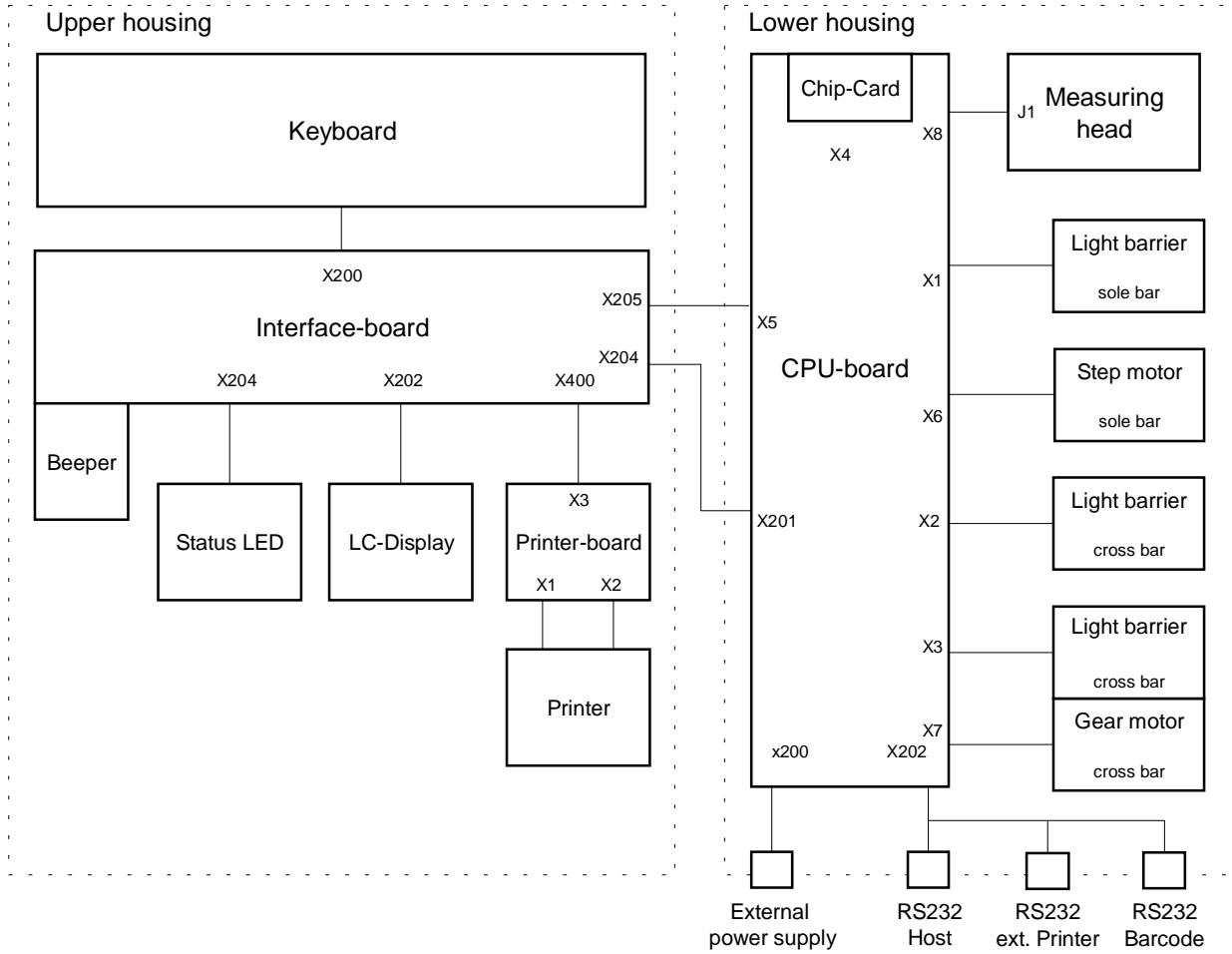

Fig.: E-Block

10. Electronics

10.2 Power supply



Fig. 30

Mains power is supplied via an external mains power supply (Fig. 30). The mains power inlet is protected with pigtail fuses 1.25A/slow at 2 contacts. The mains power supply provides supply voltages of +5V to +12V to the instrument.

PTCs (poly switches) act as current limitation for both voltages. The PTCs are resettable. They turn on again once an error is corrected after responding.

The output voltage is connected to the rear of **Miditron® Junior II** via an 8-contact jack connection (Fig. 30) and a screened power cable of 1 m of length with a Western plug moulded on both sides and directly enters the Master-Board. The instrument is connected to the mains power via a mains cable with an appliance inlet plug.



Fig. 59

The supplied version of the connecting cable has an integrated ferrite core at one end, which is the end that has to be connected to Miditron® Junior II.



Electric Data 12V Output	
Nominal voltage:	+12V
adjusted to:	+12V
Adjusting accuracy:	±1%
Static accuracy:	±5%
Voltage standing wave ratio (100Hz)	<120mV p-p
Oscillation amplitude:	<120mV p-p (Ripple and Noise)
Nominal current:	1.6A
Cut-off of current limitation:	approx. 3.7A @ Ue=110V approx. 6.1A @ Ue=230V

Table: tab-19e

Current limitation makes the output statically and dynamically short-circuit proof yet not permanently overload protected. Longterm current overloads exceeding 1.5 times the nominal current may cause damage to the mains power supply. Genuine short circuits will not cause damage, however.

10. Electronics

Electrical Data 5V Output	
Nominal voltage:	+5V
adjusted to:	5.5V
Adjusting accuracy:	±1%
Accuracy:	±5% - 7%
Voltage standing wave ratio (100Hz)	<100mV p-p
Oscillation amplitude:	<100mV p-p (Ripple and Noise)
Nominal current:	2.0A
Cut-off of current limitation:	approx. 4A

Table: tab-20e

Current limitation makes the output statically and dynamically short-circuit proof.

10. Electronics

10.3 Electronic modules

10.3.1 PCB Main

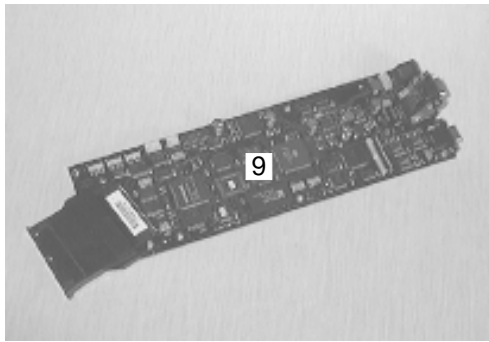

Fig. 47

The mainboard (9) is screwed to the base plate of **Miditron**[®] Junior II. The plug for the voltage supply, the serial interface and the ROM-card are directly soldered. All other components (light barriers, motors ...) are connected to the PCB Main via cable and plug. The PCB Interface and the PCB Measuring Head also belong to the connected components.

The **Miditron**[®] Junior II is supplied via an external DC mains adapter with 5V for the printing device and 12 V for the supply of the other electronic.

The PCB Main contains the following functional groups:

- Power supply with fuses
- Mains adapter + 5V, +/- 12 V
- Hardware core with 80535 processor, decoding logic
- Boot-memory (EPROM), program memory (FLASH), data memory (RAM) and memory for permanent data (EEPROM)
- Real time clock, battery buffer with 114 bytes freely disposable RAM
- Uncoupled ROM-card-slot for memory card 64 KB and 128 KB
- 3 serial interfaces, RS 232
- Interface to measuring head board with switch to control the LEDs and evaluation of U/f-converted receiver signal
- Control to contact measuring head board
- Interface to PCB Interface with printer controller, display, signal transmitter, status LED and keyboard
- Stepper control for motor measuring head unit
- DC-motor-control for motor belt drive cross transport
- 3 light barrier inputs

10. Electronics

Voltage supply

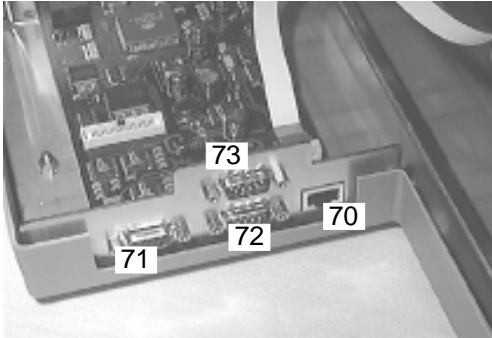

Fig. 20

The voltage is supplied via an 8-pin western plug X200 (70).

Plug functions:

PIN	SIGNAL	FUNCTIONS
1	+ 12V	Supply main board (max. 1.15 A)
2	+ 12V	
3	GND- 12	GND Main board
4	GND- 12	
5	GND- 5	GND printer
6	GND- 5	GND
7	+5V	Printer supply (max. 2,8 A)
8	+5V	internal printer

Table: tab-15e

The GND connections are directly at the plug and led to the GNDM-plane.

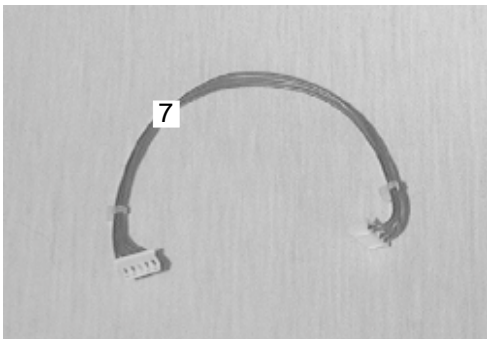

Fig. 53

The 5 V supply voltage for the printer is directly led to the PCB Interface via a connection cable (7) and the plug X201. In addition, this voltage supplies external instruments which are connected to the interface plugs barcode reader (71), Host PC (72) and external printer. The voltage is uncoupled via thermal fuses (F201 and F202) with an electricity limit of approx. 300 mA to guarantee protection from short circuit.

The system voltages + 5V and +/- 12 V are generated from the 12 V voltage supply. the incoming electricity is limited to approx. 1.5 A with the thermal protection fuse. All used fuses are functioning after an overload.

10. Electronics

Light barrier control, Registration of counts

Miditron® Junior II has 3 LBs for the control and monitoring of the motor belt drive cross transport and the motor measuring head unit. The LBs are connected to the PCB Main via plugs. The LBs are:

- plug (15) LB measuring head home position; it determines the home position of the measuring head.
- plug (13) LB reference position; it is used as reference position for the movement of the measuring head.
- plug (14) LB home position; it determines the home position of the cross transport.

The timing to control the LBs and to measure the initial frequency of the U/f-converter on the analog board is realized via 4 counters (three settable via SW) by partitioning the initial frequency of the micro controller.

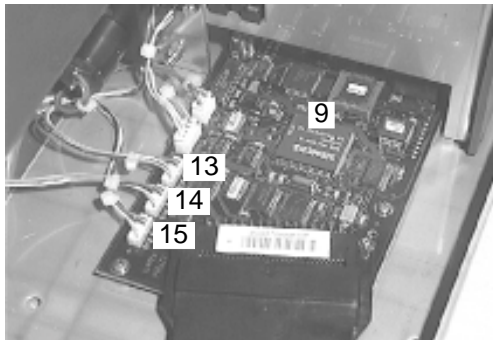

Fig. 19

Motor control measuring head drive

The motor measuring head drive is connected to the PCB Main via a plug (12). The 2 phases step motor is contacted with a driving component. This component has 6 inputs which can be contacted from the micro controller. A total, half and micro step use is realized by a corresponding contact. The motor realizes 8 steps when used with half steps.

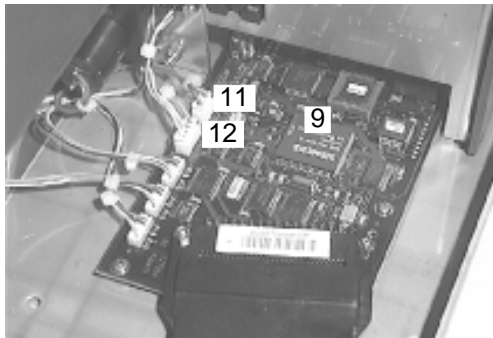

Fig. 19

Motor control motor belt drive cross transport

The motor belt drive cross transport is connected to the PCB Main via a plug (11). The DC-motor is contacted via a driving component,. This component contains a transistor full bridge. Therefore, a 4 quadrant use is possible when contacted correspondingly by the micro control.

10. Electronics

10.3.2 PCB Interface

The PCB Interface (20) is screwed to the top of housing. It is connected to the PCB Main via a 40 pin cable (27). The supply voltage for the printer (26) is made via a separate 5 pin cable.

The PCB Interface (20) contains the following functions:

- connection of the display
- connection of the keyboard with keyboard query
- connection of the printer
- printer control with printer interface
- connection of status LED
- signal transmitter

Voltage supply internal thermo printer

The voltage for the printer is supplied via a separate 5 pin cable (26) from the PCB Main to the PCB Interface (20).

Plug functions:

PIN	SIGNAL	FUNCTIONS
1	+5V	printer supply
2	GND- 5	GND printer
3		not connected
4	GND- 5	GND printer
5	+5V	printer supply

Table: tab-16e

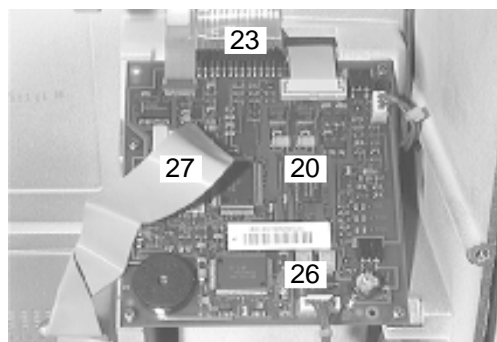

Fig. 23

Electricity of approx. 3A is available via a parallel connection of the fuses F200 and F201. The fuses can be used after an overload.

Signal transmitter

The signal transmitter is soldered to the PCB Interface (20). It needs electricity of approx. 3mA.

Display

The display is connected to a 14 pin spring rail. It is controlled via the PCB Main.

10. Electronics

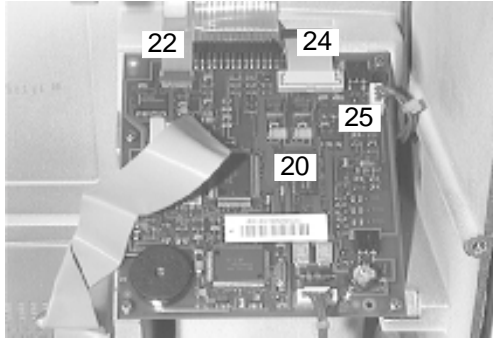

Fig. 23

Status LED

The status LED is connected to the PCB Interface via a plug (25)

Keyboard

The keyboard control is integrated to the PCB Interface (20). The keyboard is connected to the PCB Interface via a plug (22).

Plug function:

PIN	SIGNAL	FUNCTIONS
1	Y5	Scan- Lines (Y5...Y1)
2	Y4	
3	Y3	
4	Y2	
5	Y1	
6	X4	Select- Rows (X4...X1)
7	X3	
8		not connected
9	LF-1	printer - feed
10	LF-2	printer - feed
11	X2	
12	X1	

Table: tab-17e

Printer

The printer control is integrated to the PCB Interface. The printer is connected to the PCB Interface via a plug (24).

10. Electronics

10.3.3 Display

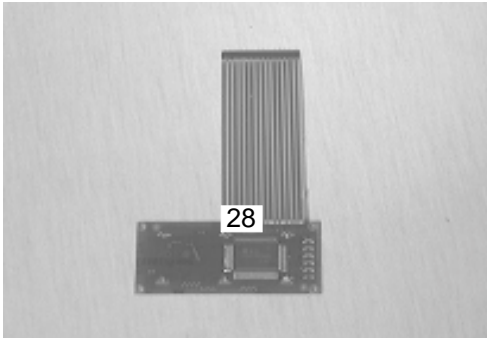

Fig. 51

The display (28), a LCD-display, has a line with 16 digits. The display is connected to the PCB Interface with a plug (14 pin spring rail). It is controlled by the PCB Main with 4 bit data and 3 control signals. The contrast is ruled via a voltage factor on the PCB Main, as well.

10.3.4 Printer

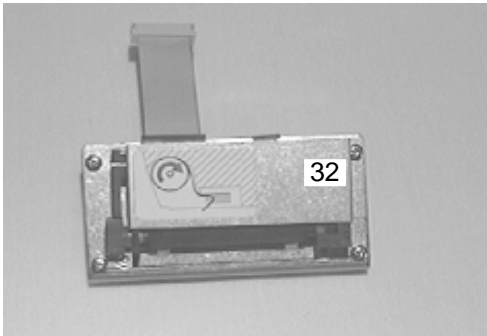

Fig. 49

The printer, a SEIKO LP 1245, is connected to the PCB Interface with a plug (24). Here the printer control is also located. The printer control has an internal clock. A temperature measuring takes place in the printing head. In case of overheating, an error signal occurs and an error report is shown in the display. The printer is supplied with electricity from the PCB Main via an additional cable.

Plug functions:

PIN	SIGNAL	FUNCTIONS
1	+5V	printer supply
2	GND- 5	GND printer
3		not connected
4	GND- 5	GND printer
5	+5V	printer supply

Table: tab-16e

Electricity of approx. 3A is available via a parallel connection of the fuses F 200 and F201. The fuses can be used after an overload.

10.3.5 Status LED

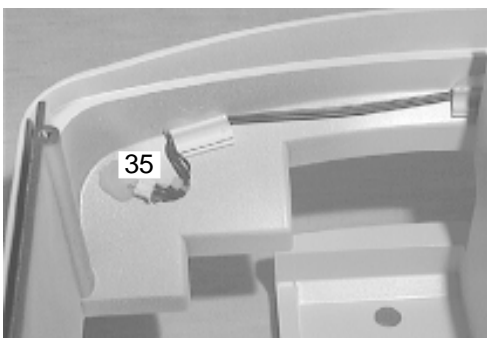

Fig. 27

The status LED shows different conditions of the instrument via the colors red or green. Possible indications are for example:

- green: instrument is read for measurement
- red: instrument has stand-by mode
- red during measurement: do not insert measuring strip
- green during measurement: insert measuring strip

10. Electronics

10.3.6 Keyboard



Fig. 28

The keyboard control is integrated to the PCB Interface. The keyboard is connected to the PCB Interface via a plug.

plug functions:

PIN	SIGNAL	FUNCTIONS
1	Y5	Scan- Lines (Y5...Y1)
2	Y4	
3	Y3	
4	Y2	
5	Y1	
6	X4	Select- Rows (X4...X1)
7	X3	
8		not connected
9	LF-1	printer - feed
10	LF-2	printer - feed
11	X2	
12	X1	

Table: tab-17e

10.3.7 PCB Measuring Head

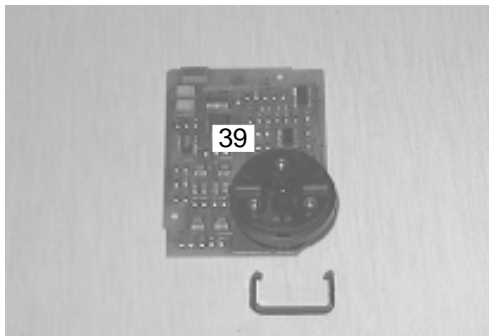

Fig. 42

The PCB Measuring Head (39) contains the measuring optic. Here the test strip is measured. It is connected to the PCB Main via a cable. This cable can be removed on both boards.

10. Electronics

10.3.8 Light Barrier Measuring Head Home Position



Fig. 9

The LB measuring head home position (46) determines the home position of the measuring head. The LB is connected to the PCB Main via a plug.

The timing to contact all 3 LBs and to measure the initial frequency of the U/f-converter on the analog board is realized via counters (three settable via software) by partitioning the initial frequency of the micro control.

Plug functions:

PIN	SIGNAL	FUNCTIONS
1	+ LED	+ LED VCC
2	GND	
3		not connected
4	+5V	amplifier supply
5	LSSMREF	signal LSSMREF

Table: tab-18e

10.3.9 LB Home Position Cross Transport

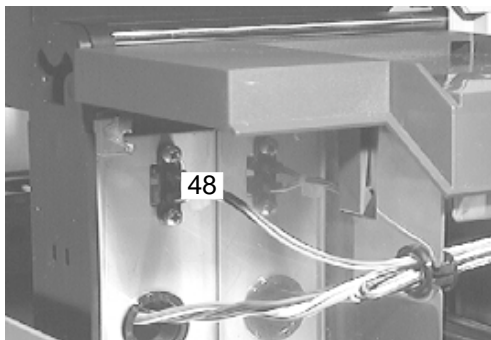

Fig. 13

The LB home position determines the home position of the cross transport. The LB is connected to the PCB Main via a plug.

The timing to contact all 3 LBs and to measure the initial frequency of the U/f-converter on the analog board is realized via counters (three settable via software) by partitioning the initial frequency of the micro control.

Plug functions:

PIN	SIGNAL	FUNCTIONS
1	+ LED	+ LED VCC
2	GND	
3		not connected
4	+5V	amplifier supply
5	LSDCPOS	signal LSDCPOS

Tabelle: tab-13e

10. Electronics

10.3.10 Light barrier reference position cross transport



Fig. 10

The LB reference position determines the reference position for the movement of the cross transport. The LB is connected to the PCB Main via a plug.

The timing to contact all 3 LBs and to measure the initial frequency of the U/f-converter on the analog board is realized via counters (three settable via software) by partitioning the initial frequency of the micro control.

Plug functions:

PIN	SIGNAL	FUNCTIONS
1	+ LED	+ LED VCC
2	GND	
3		not connected
4	+5V	amplifier supply
5	LSDCEND	signal LSDCEND

Tabelle: tab-14e

10.3.11 Motor Belt Drive Cross Transport

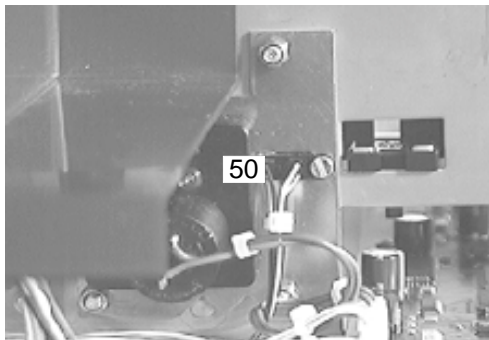
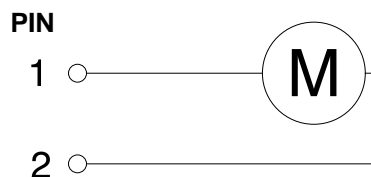

Fig. 10

The motor belt drive cross transport (50) is connected to the PCB Main via a plug. The DC-motor is contacted via a driving component. This component contains a transistor full bridge. Therefore, a 4 quadrant use is possible when contacted correspondingly by the micro control.

Plug functions:



10. Electronics

10.3.12 Motor Measuring Head Drive

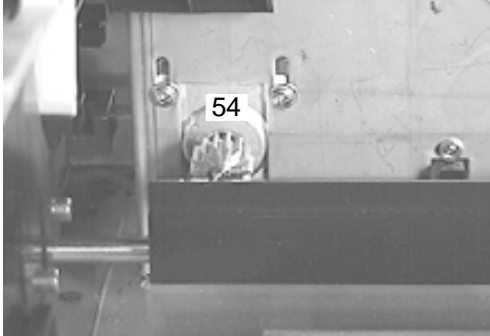
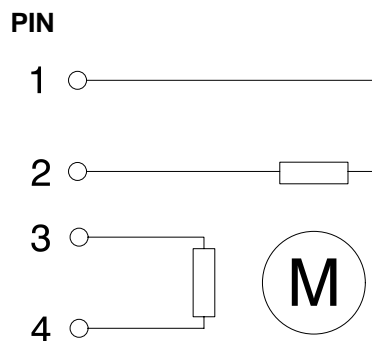

Fig. 4

The motor measuring head drive (54) is connected to the PCB Main via a plug (12). The 2 phases step motor is contacted with a driving component. This component has 6 inputs which can be contacted from the micro controller. A total, half and micro step use is realized by a corresponding contact. The motor realizes 8 steps when used with half steps.

Plug functions:



10. Electronics

10.4 Circuit diagram

10.4.1 PCB Main

PCB Main Part 1

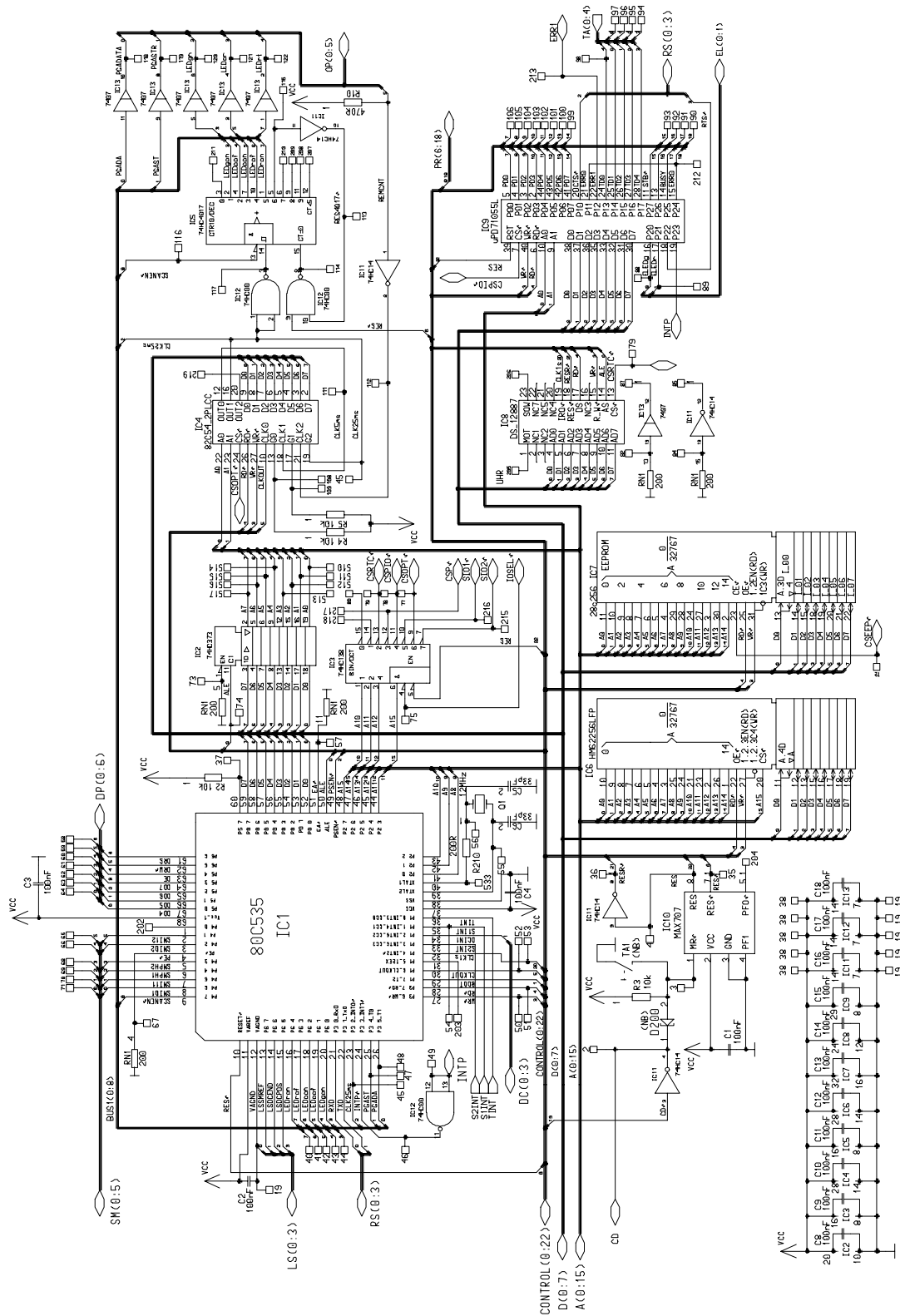

10. Electronics

PCB Main Part 2

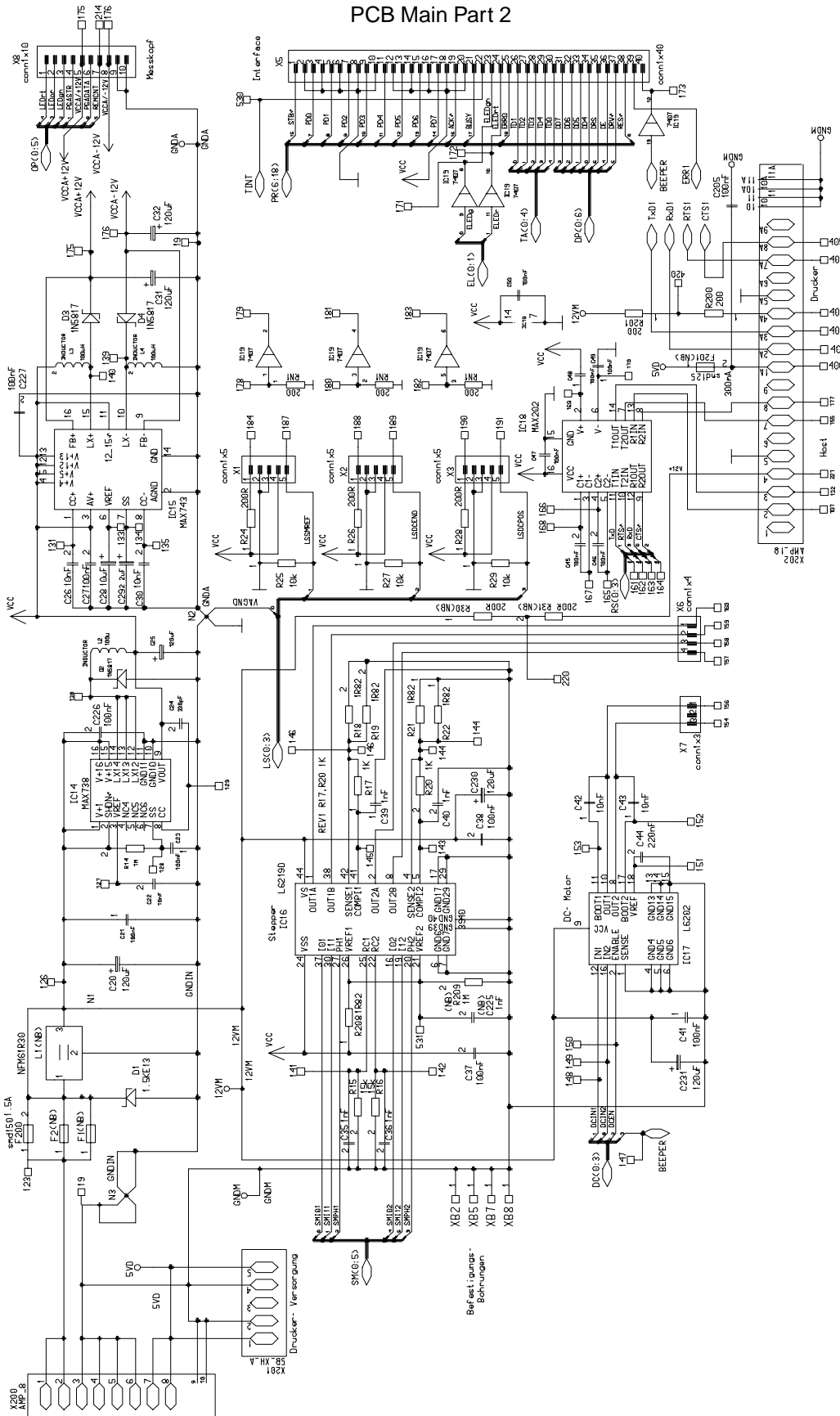

10. Electronics

PCB Main Part 3

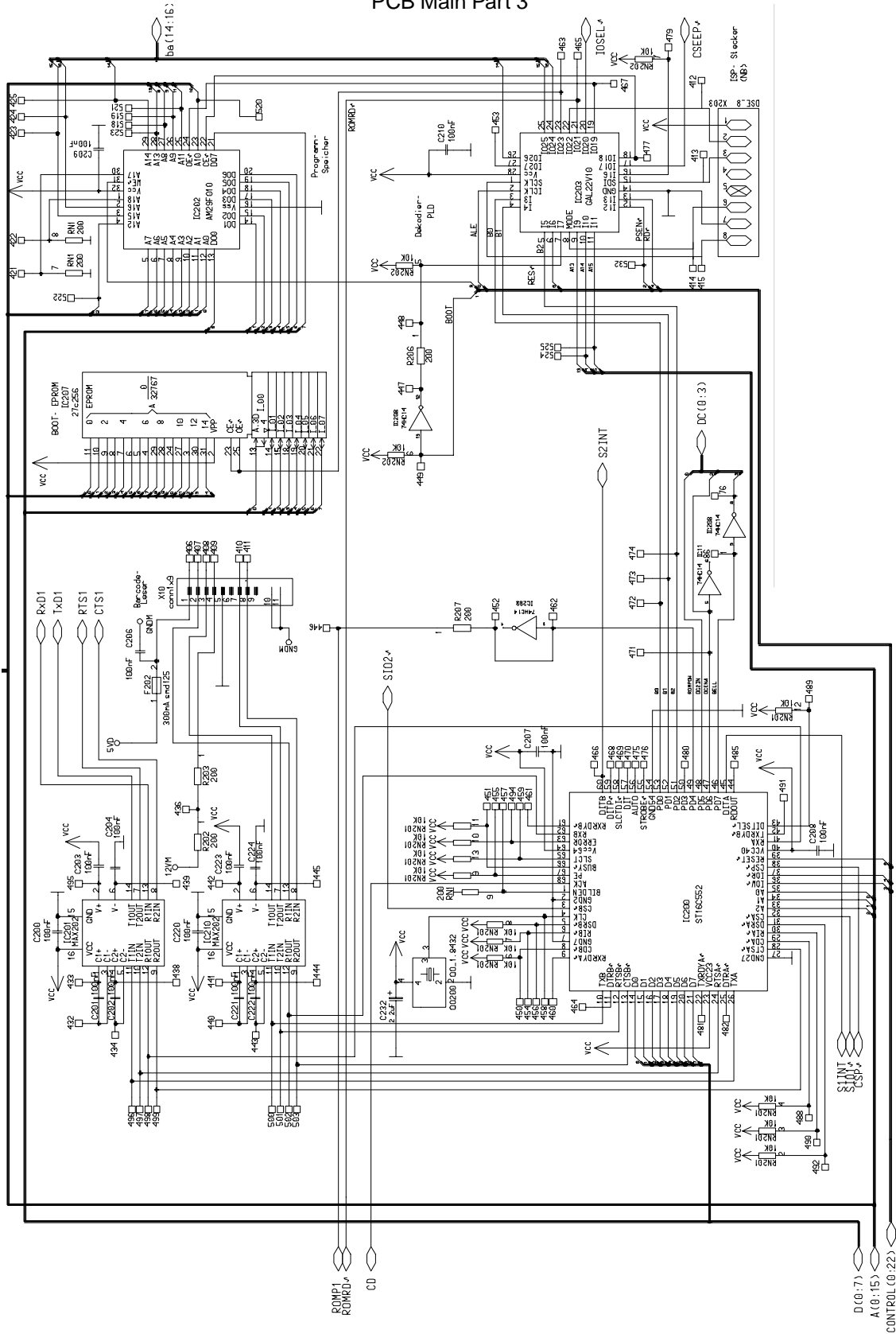

10. Electronics

PCB Main Part 4

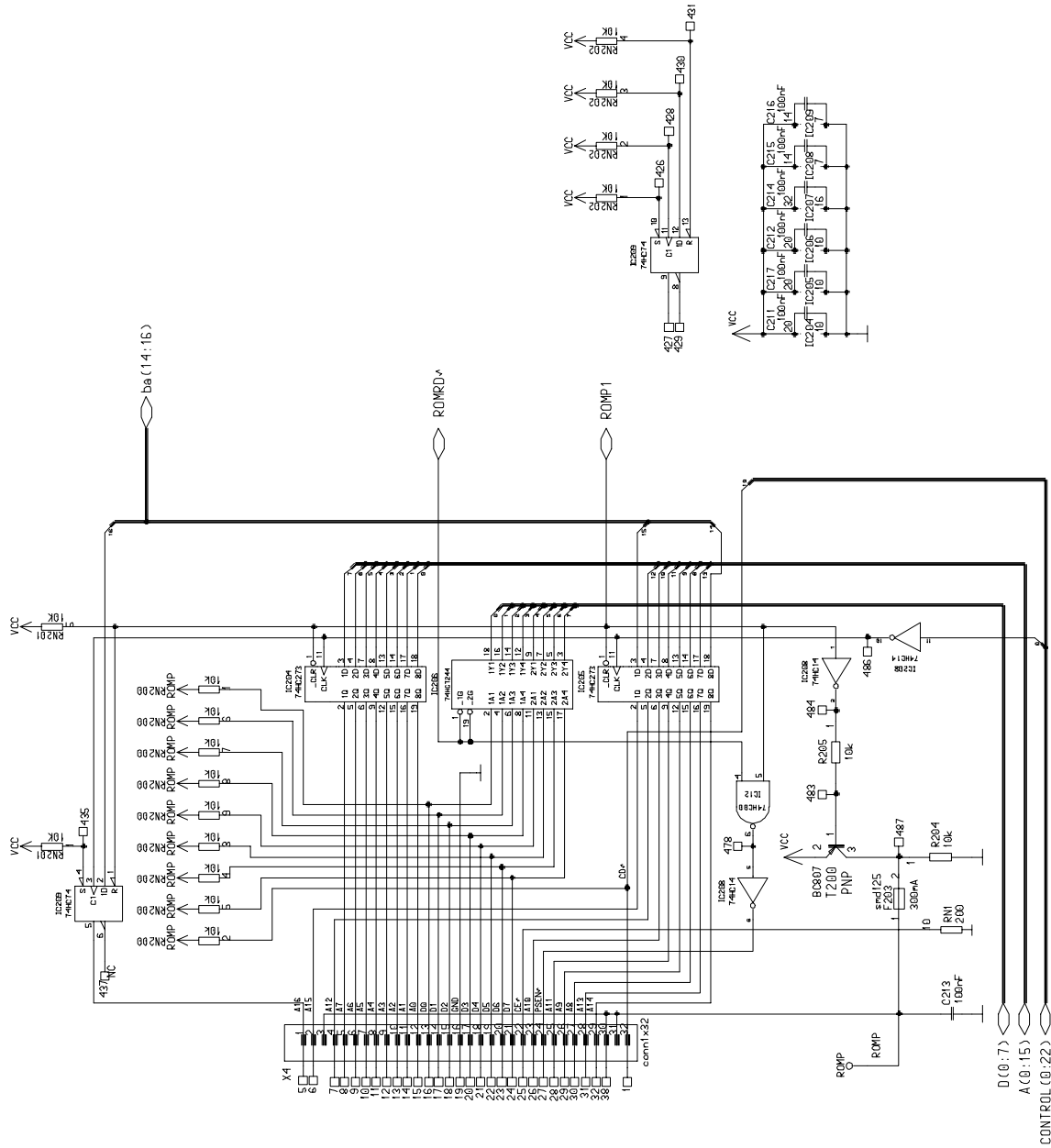

10. Electronics

PCB Main component layout

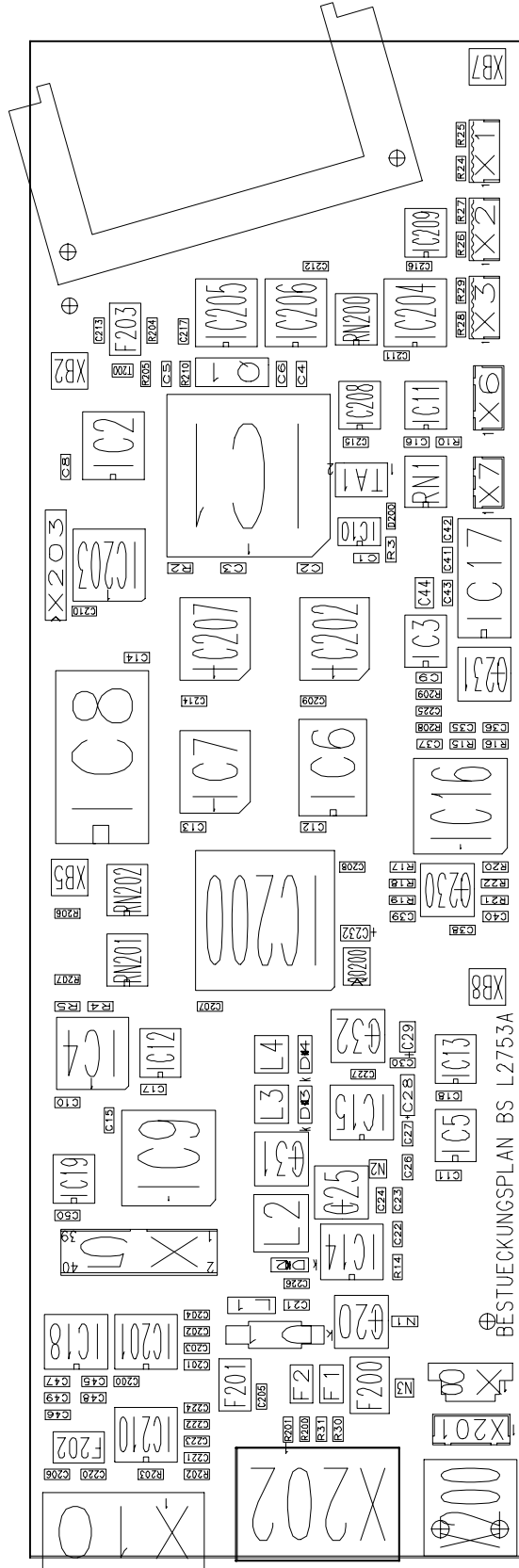

- BESTUECKUNGSPLAN BS L2753A
- N1, N2, N3 nicht bestuecken
 - D200, R209, C225, R30, R31 nicht bestueckt
 - F1, F2 nicht bestuecken
 - TA1 nicht bestuecken
 - L1 nicht bestuecken
 - X203, F201 nicht bestueckt

Best

10. Electronics

10.4.2 PCB Interface

PCB Interface Part 1 (keyboard, display, beeper and LED)

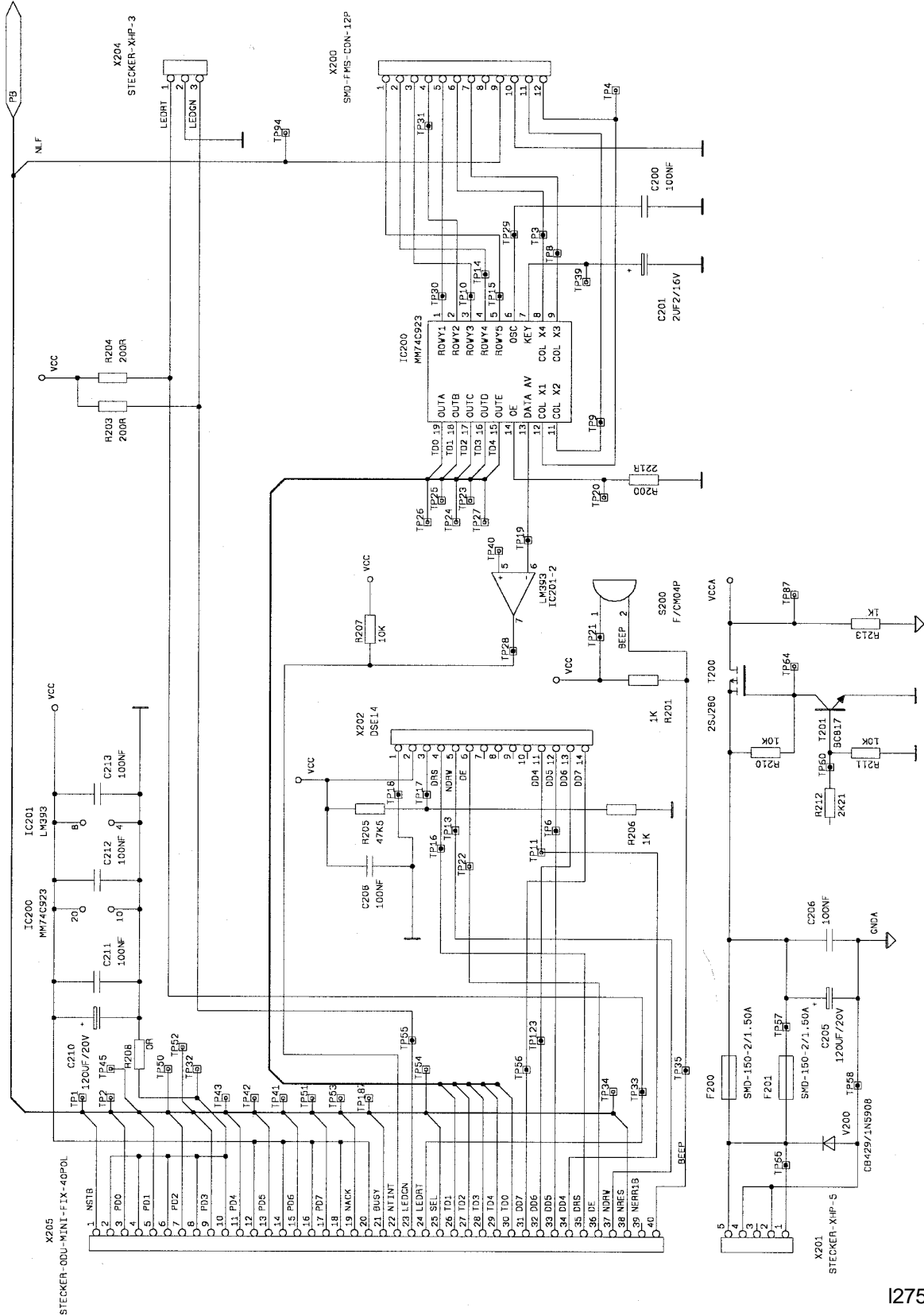

I2755a2

10. Electronics

PCB Interface Part 2 (printer control)

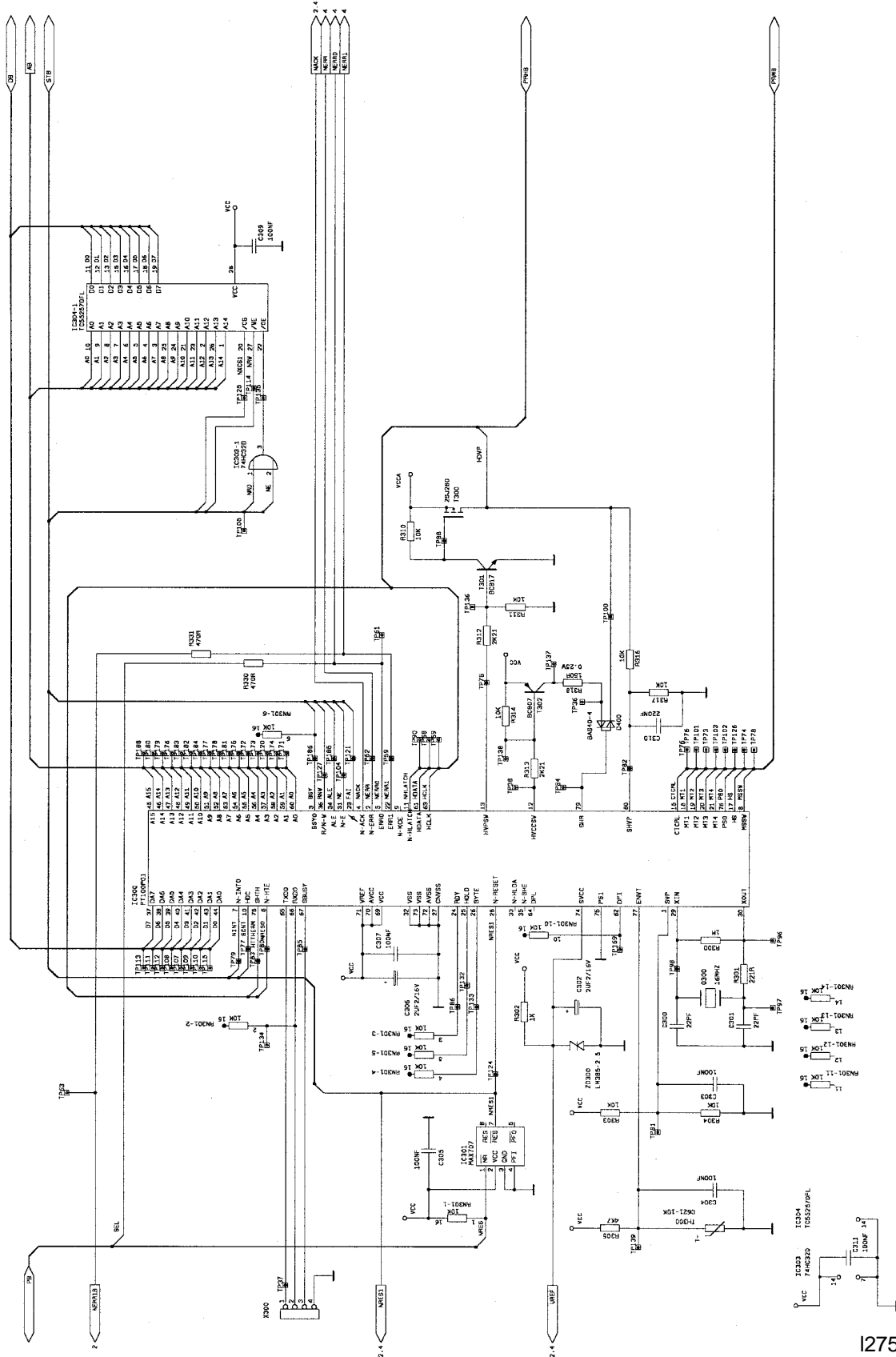

12755a3

10. Electronics

PCB Interface Part 3 (printer interface)

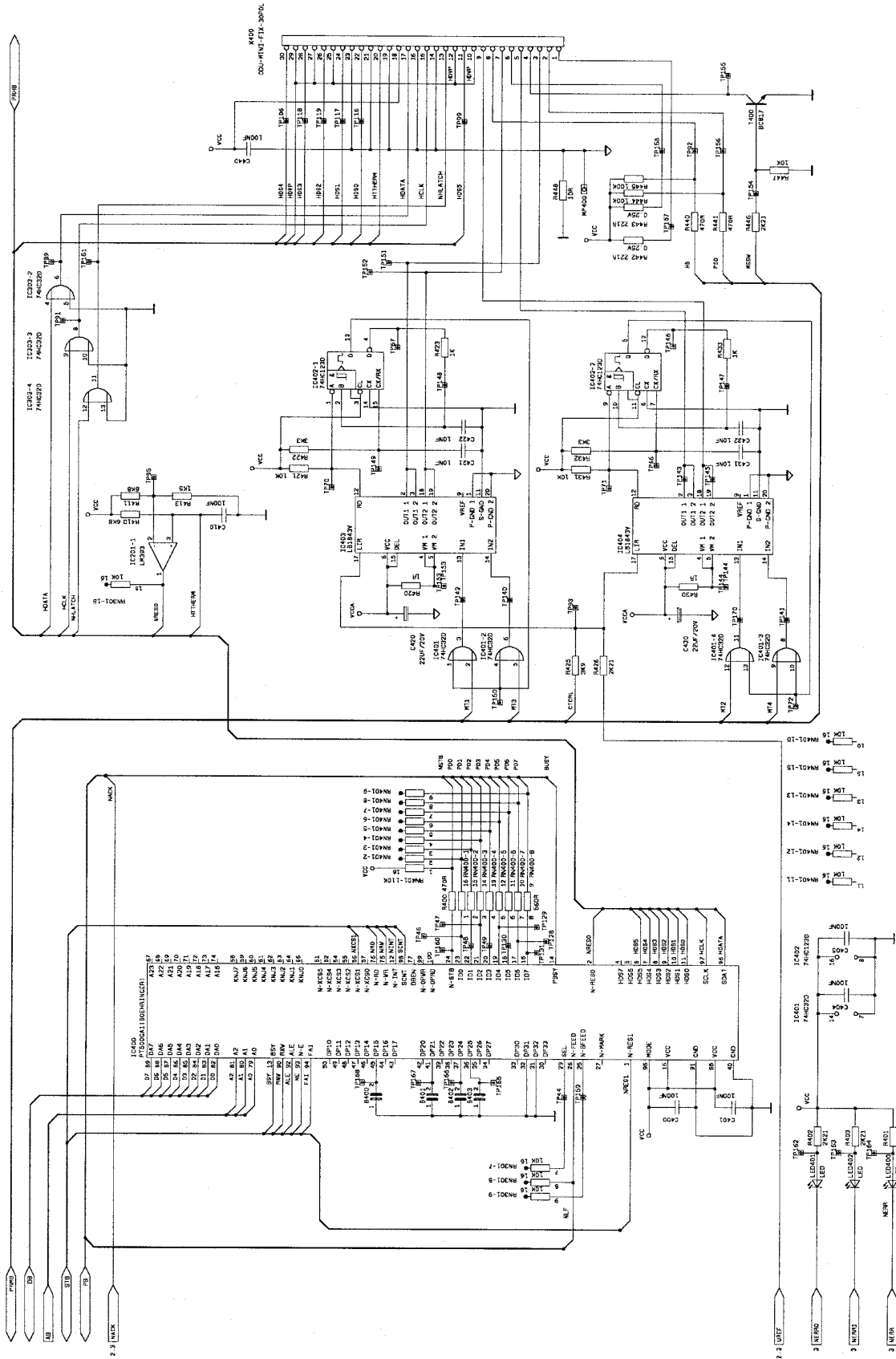

12755a4

10. Electronics

PCB interface component layout

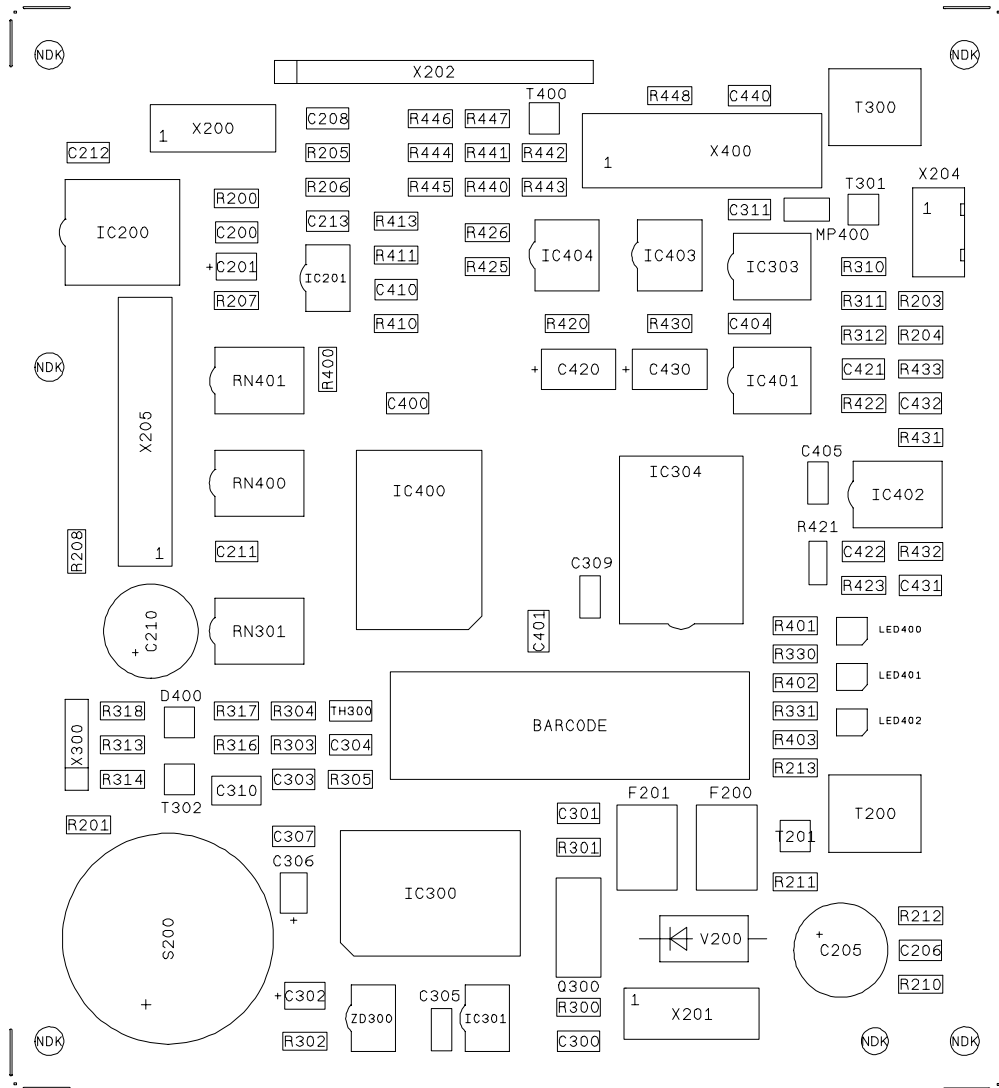

10. Electronics

10.4.3 PCB Measuring Head

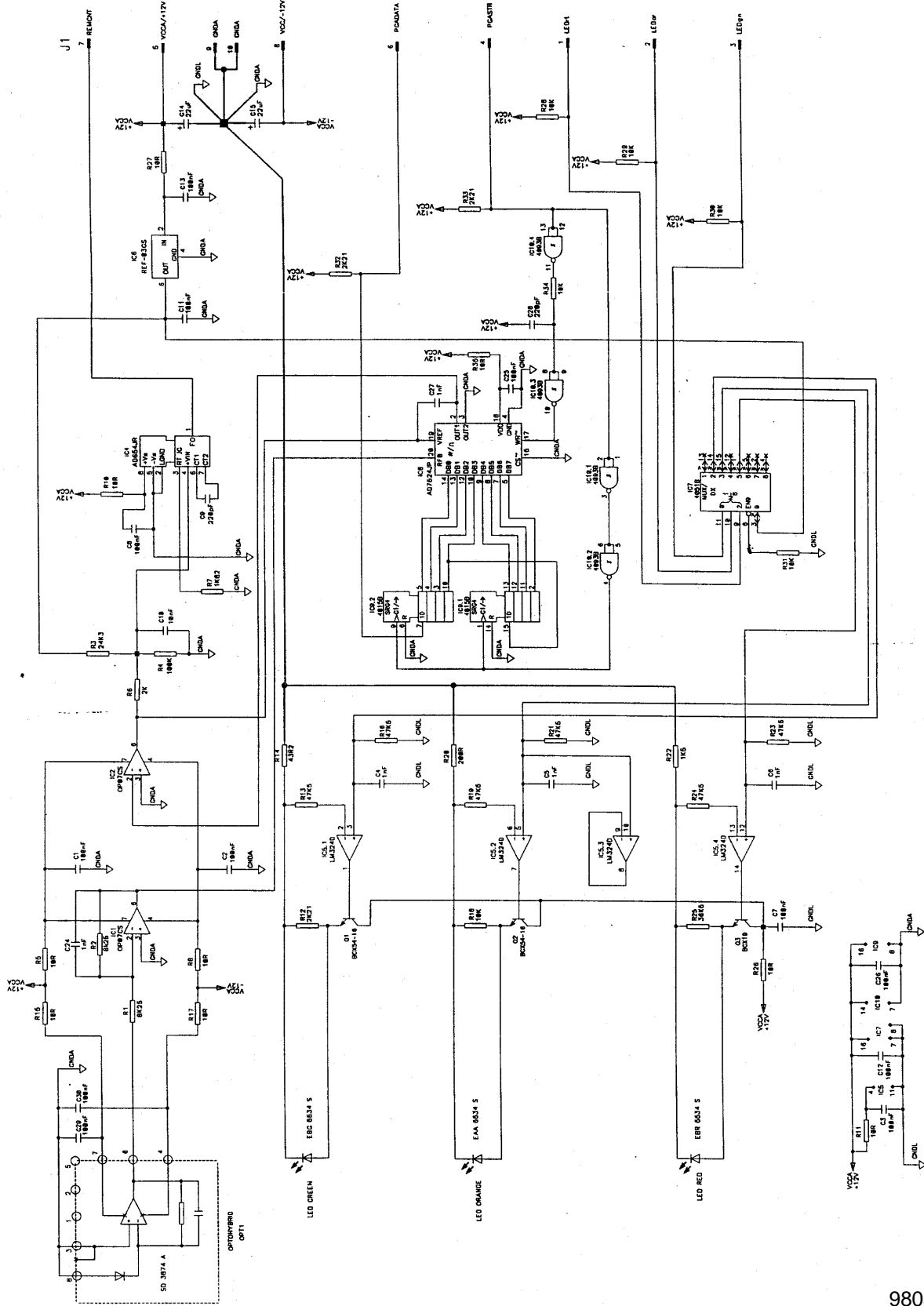

980520

11. Software

11.1 Overview

The **Miditron**® Junior II software offers 6 main menus and 1 service menu:

- The **Worklist** menu is used for manual entry and editing of Patient ID's, and of colour and clarity data, prior to measurement. This menu is also used to enter Patient ID's with an optional barcode reader.
- The **Working Mode** menu is used to set the working mode to Normal, Accelerated or Fast processing rates.
- The **Setup Reprint** menu is used to select data for reprinting. Printing is initiated by pressing the **<Reprint>** button.
- The **Setup** menu is used to customize the software to your individual laboratory needs. After the analyzer has been installed, you should select all of the desired menu options and settings. These can also be selected by Roche Mannheim Customer Support or your service agent in a software download to the printer port.
- The **Print Setup** menu can be used to generate a hard copy of the analyzer settings. When an external printer is also enabled and connected, the printout will be sent to both printers.
- The **Send to Host ?** menu is used to send the day's reports from the results memory to a PC or host computer. This menu is only displayed when "Host/PC Yes" is selected in the Setup menu. If the date changes, any batch that was being processed at the time will be sent in its entirety.

Furter information see Operator's Manual.

- Im **Service** menu kann ein status protocol ausgedruckt, Tests durchlaufen, Geräteeinstellungen per download eingespielt und eine Justage vorgenommen werden. Eine detaillierte Beschreibung finden Sie im Kapitel 7. Service mode and adjustment.

Accessing menu options:

Miditron® Junior II is in Ready Mode; you see displayed: Access to the menus is gained by pressing **<Paging>**. Press **<Paging>** to scroll (vertically) to the desired menu. Once you are in the desired menu, press **<Set>** or **<Enter>** to branch (horizontally) to individual options.

READY - <START>

"The analyzer is ready to measure"

11. Software

Closing a menu or submenu:

Press **<Start>** to close the menu and return directly to Ready Mode. When you press **<Start>** to close a menu, all of the settings made up to that point and confirmed with **<Enter>** will be saved.

11.2 Flow Diagram of Menu Selection

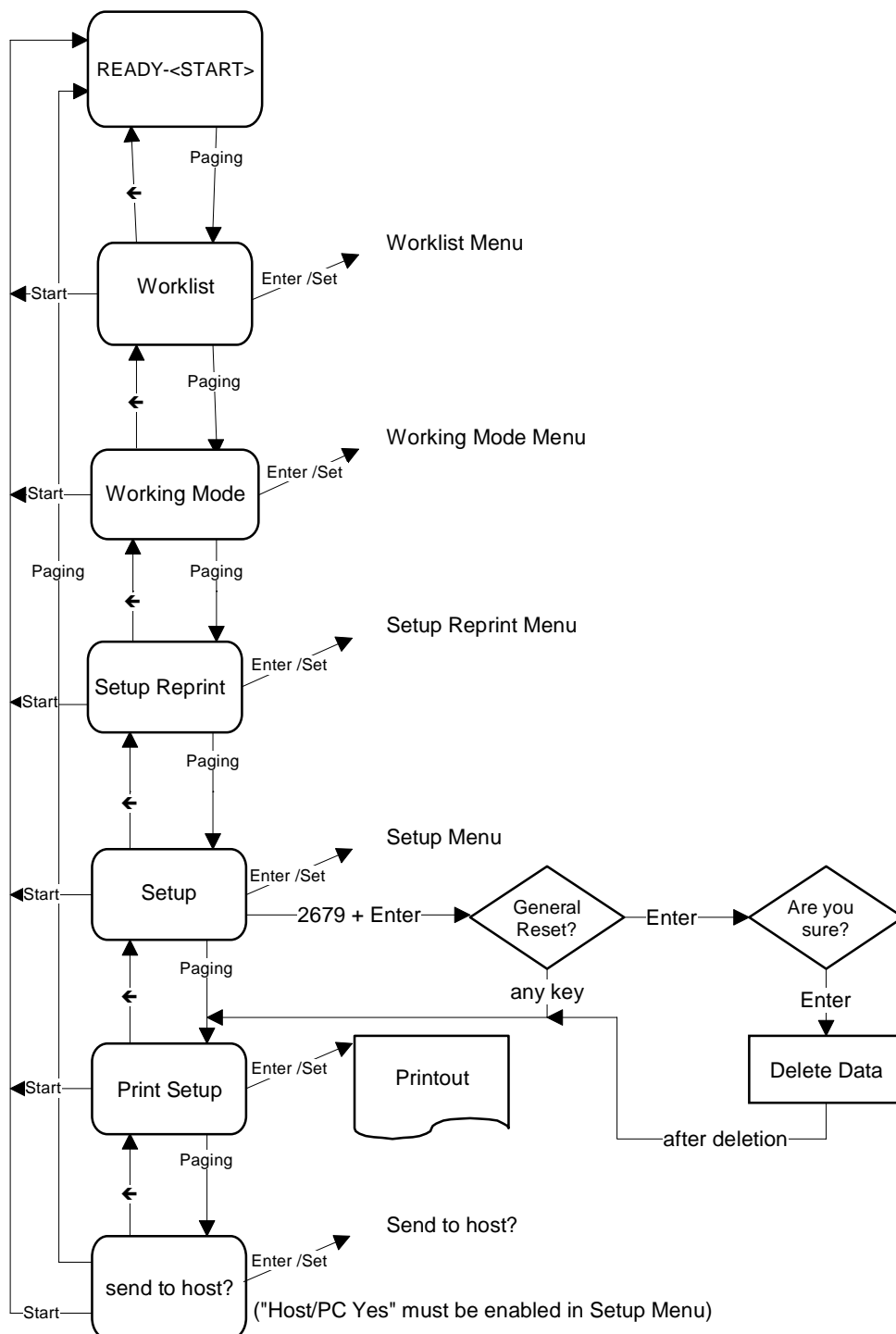

11. Software

11.2.1 Flow Diagram of the Worklist Menu

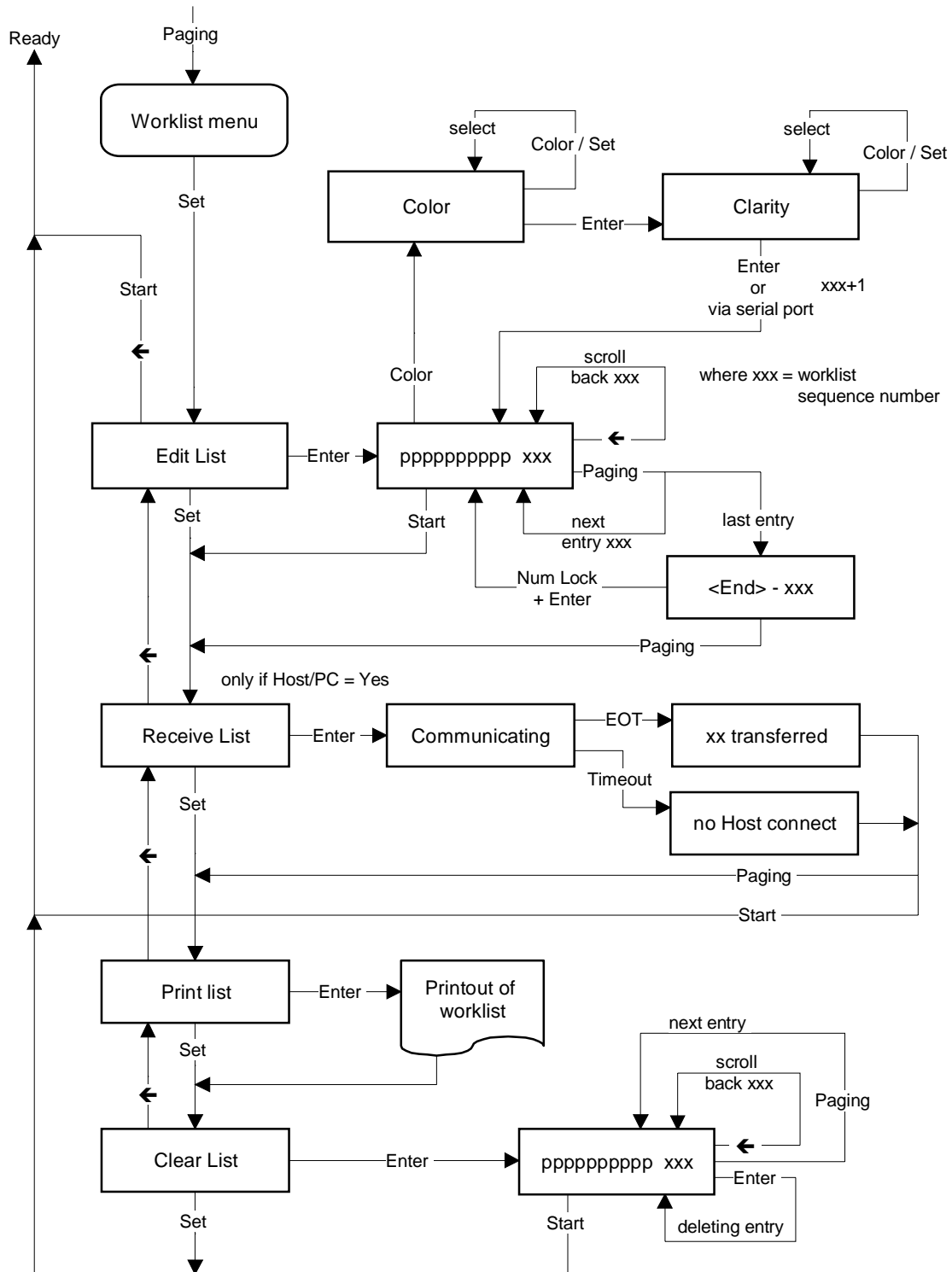

11. Software

11.2.2 Flow Diagram of the Working Mode Menu

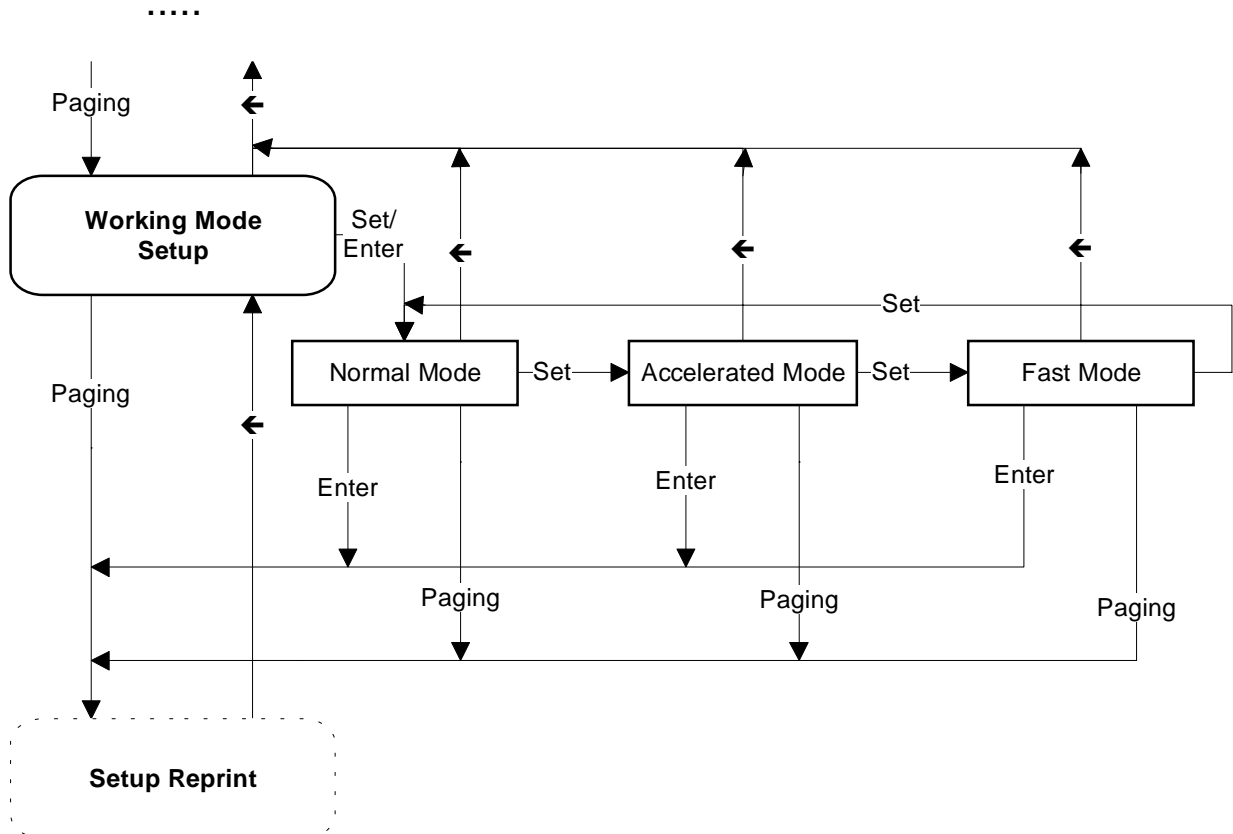

- Set** toggle menu item
- Enter** save selected menu item and switch forward
- Paging** switch forward without saving
- ←** switch backward without saving

11. Software

11.2.3 Flow Diagram of the Reprint Menu

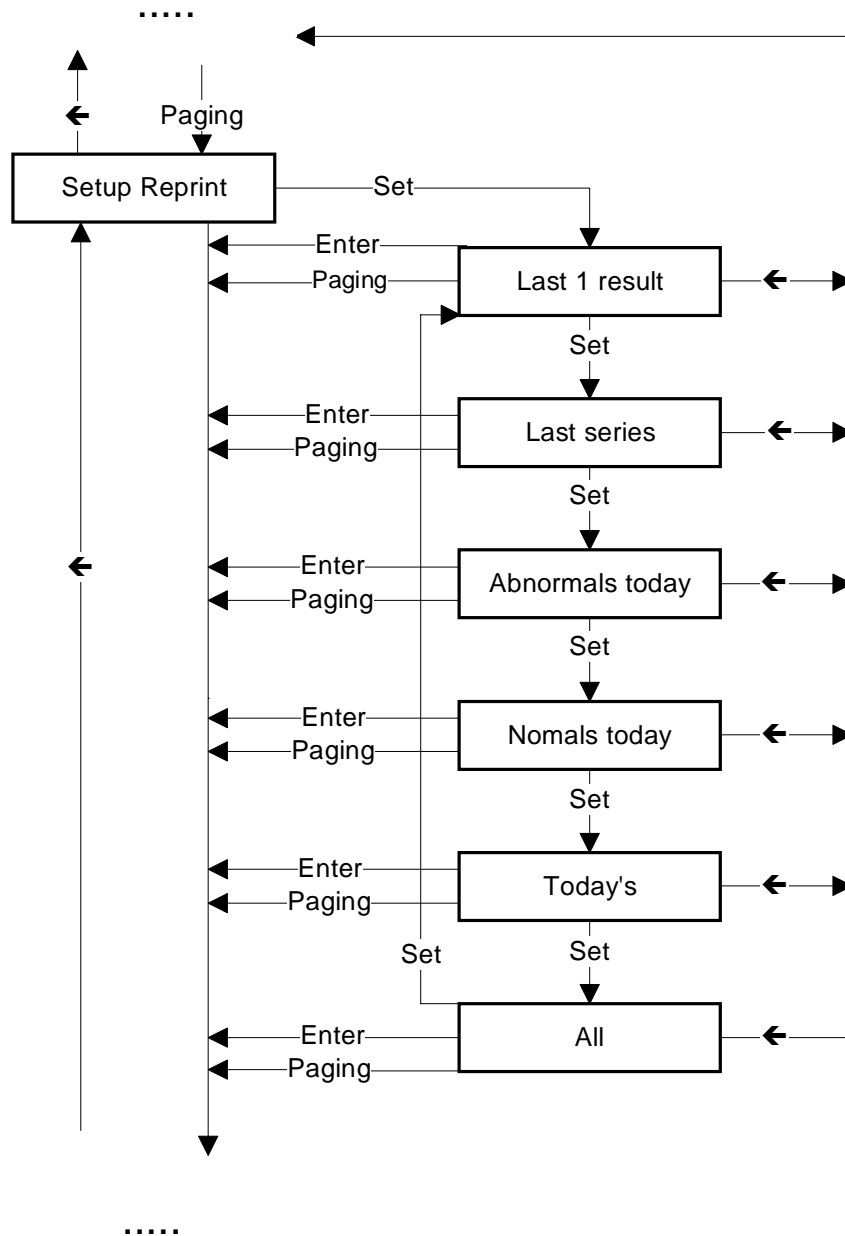

11. Software

11.2.4 Flow Diagram of the Setup Menu

Setup menu, Part 1

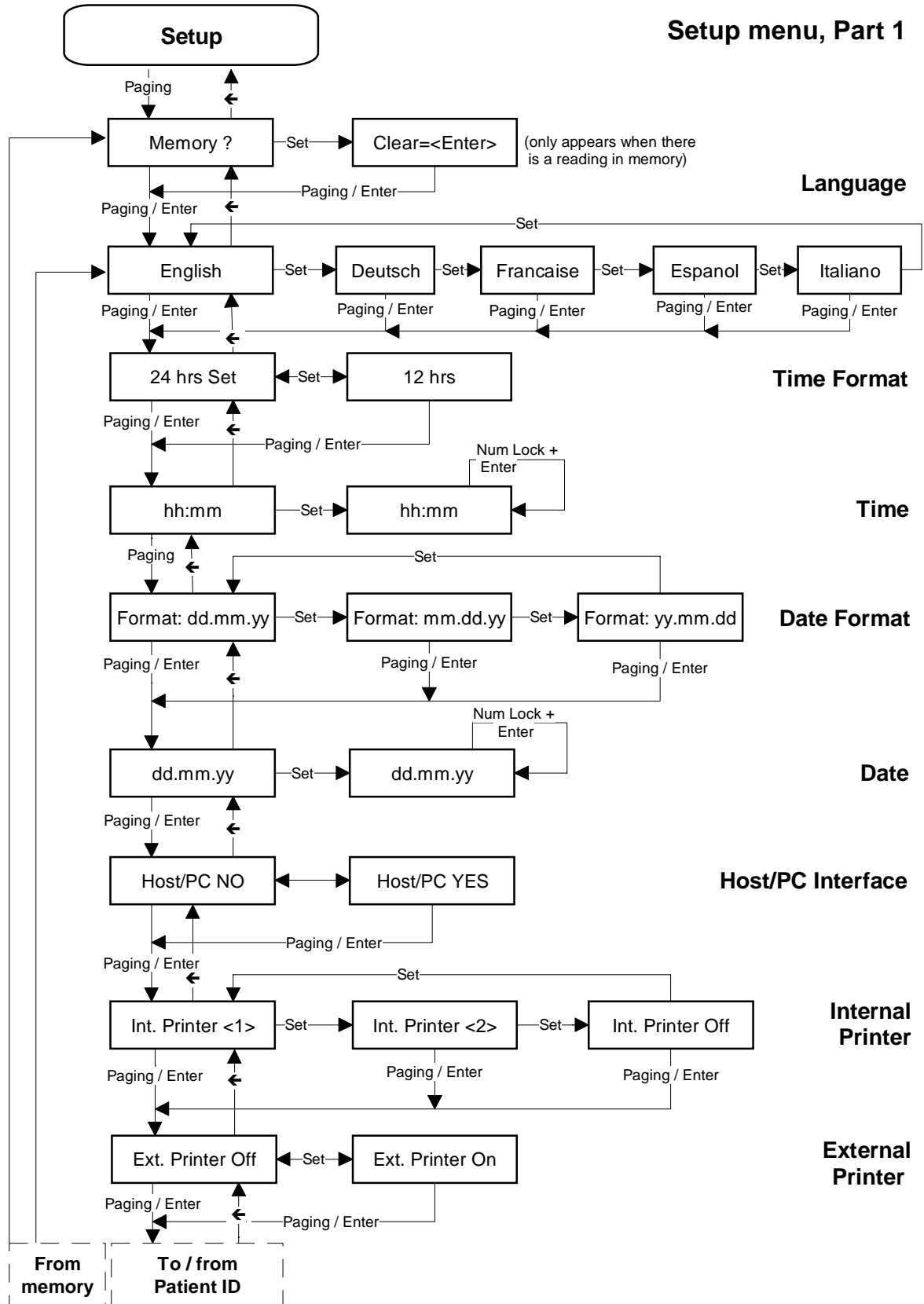

11. Software

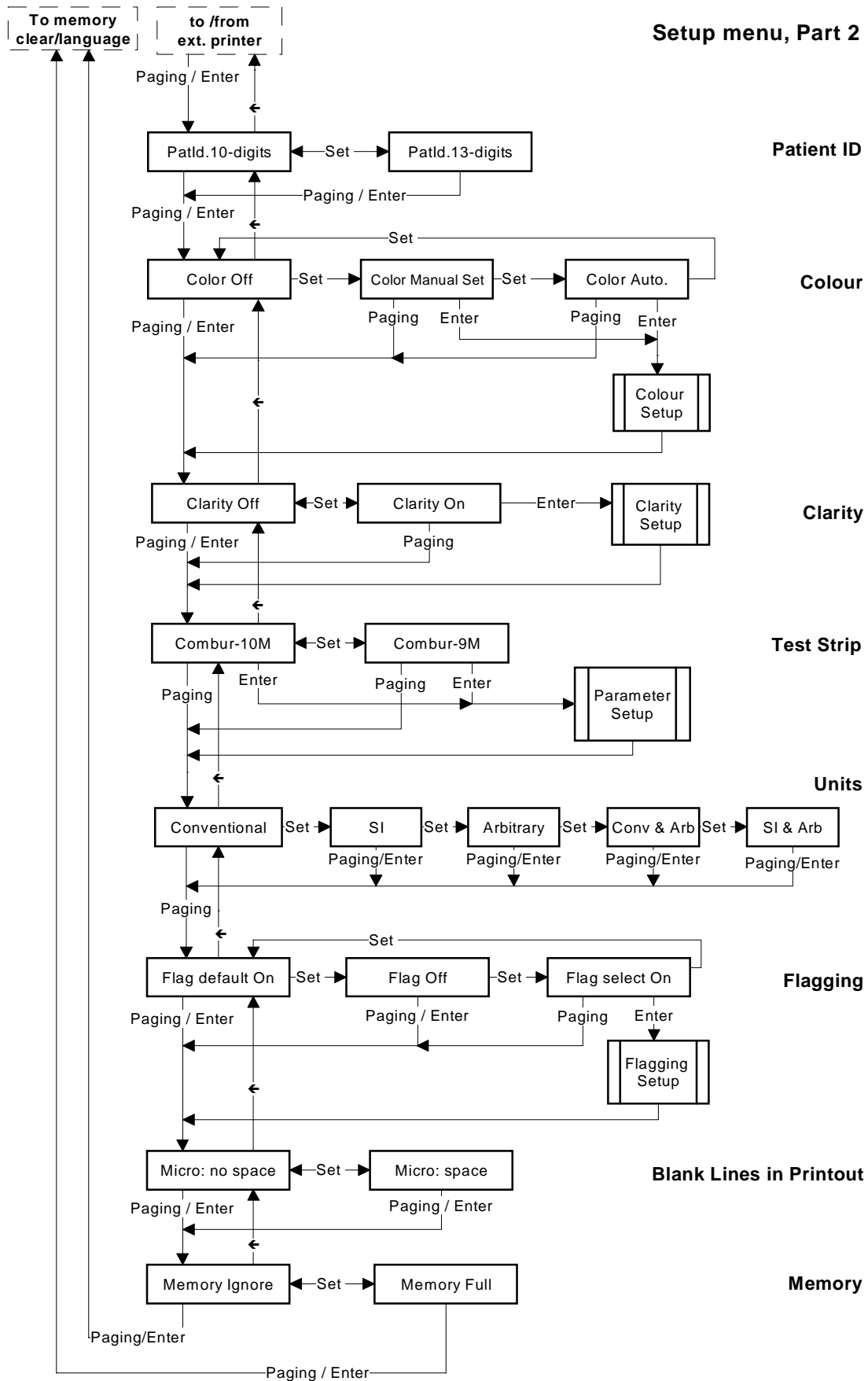

11. Software

11.2.4.1 Flow Diagram of Color Setup

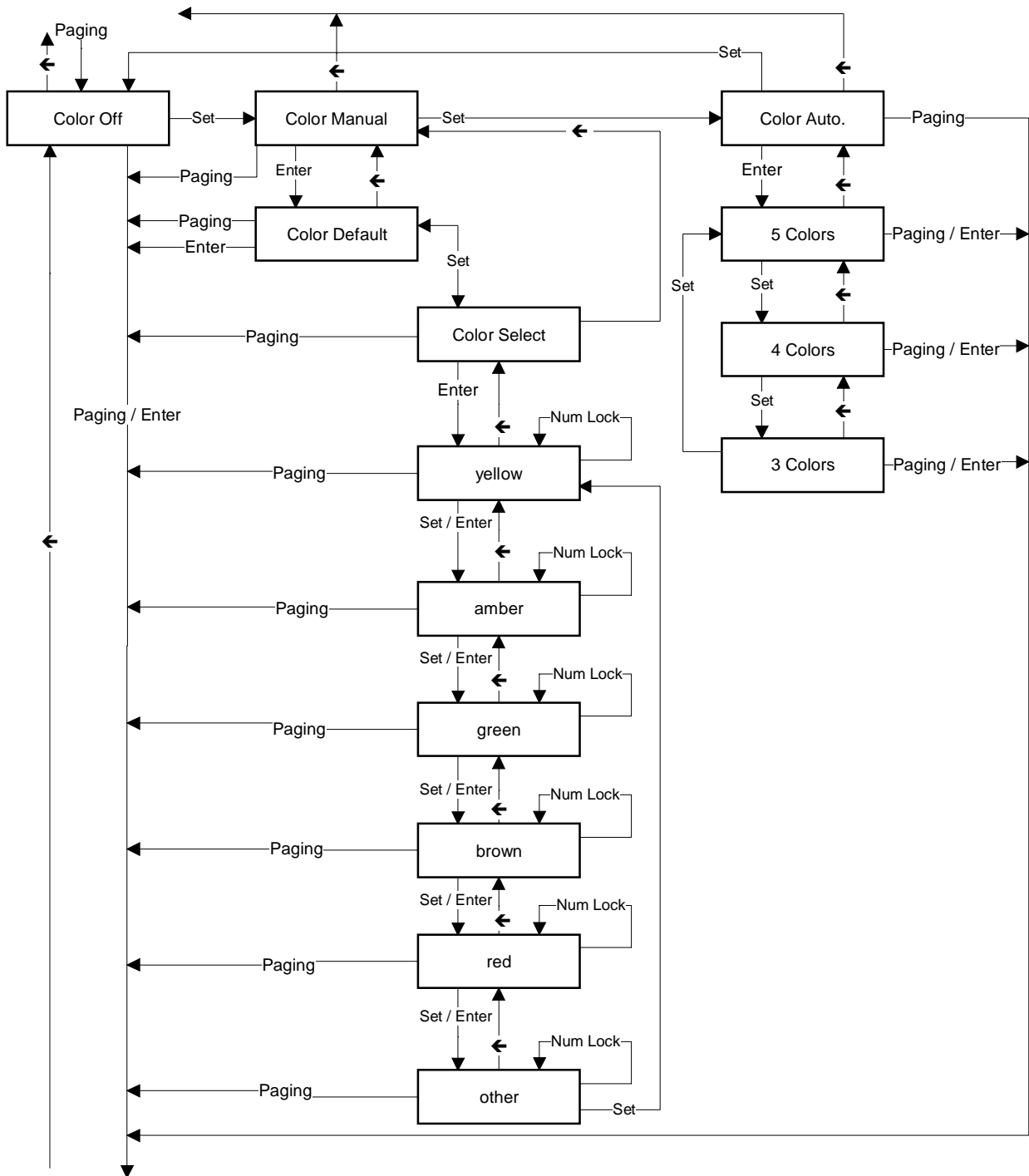

11. Software

11.2.4.2 Flow Diagram of Clarity Setup

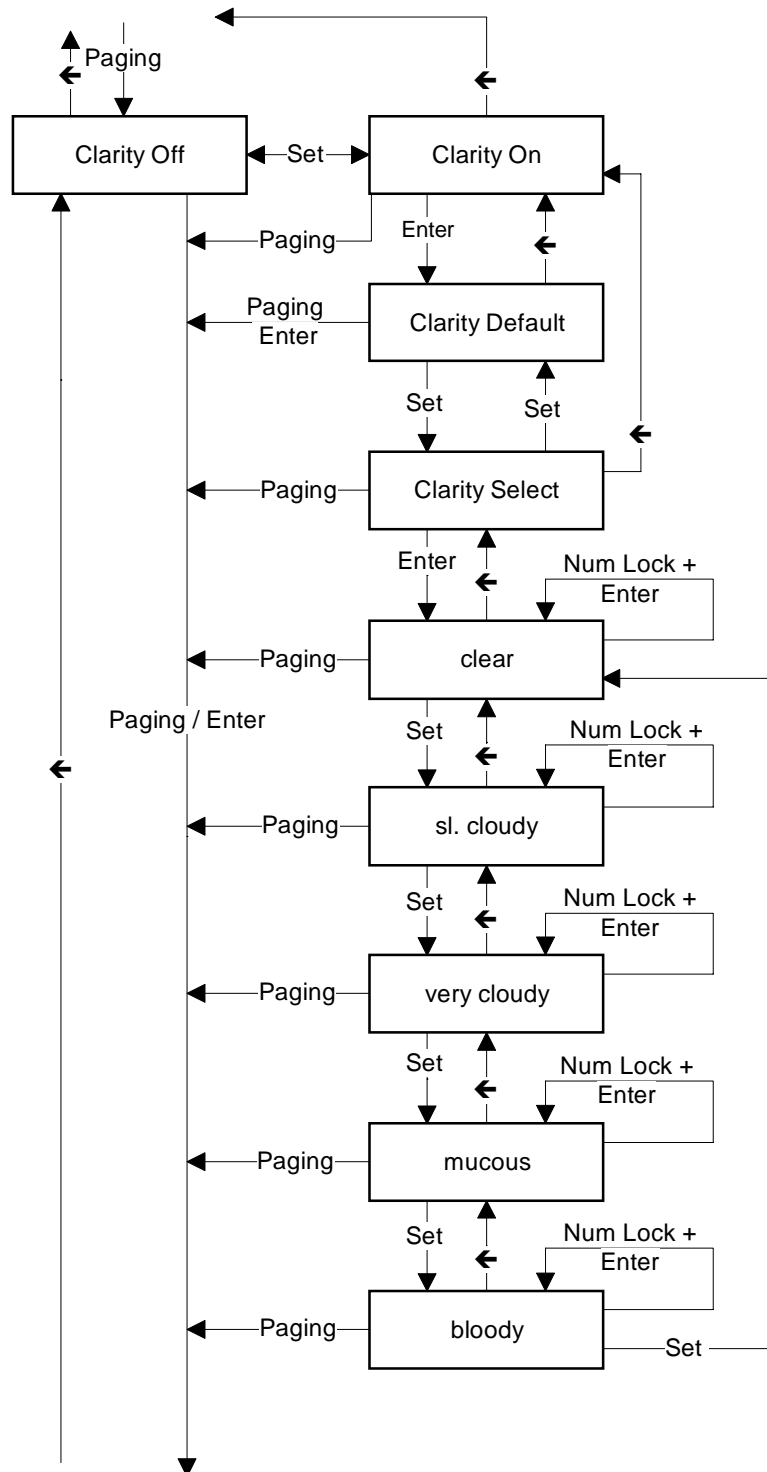

11. Software

11.2.4.3 Flow Diagram of Parameter Setup

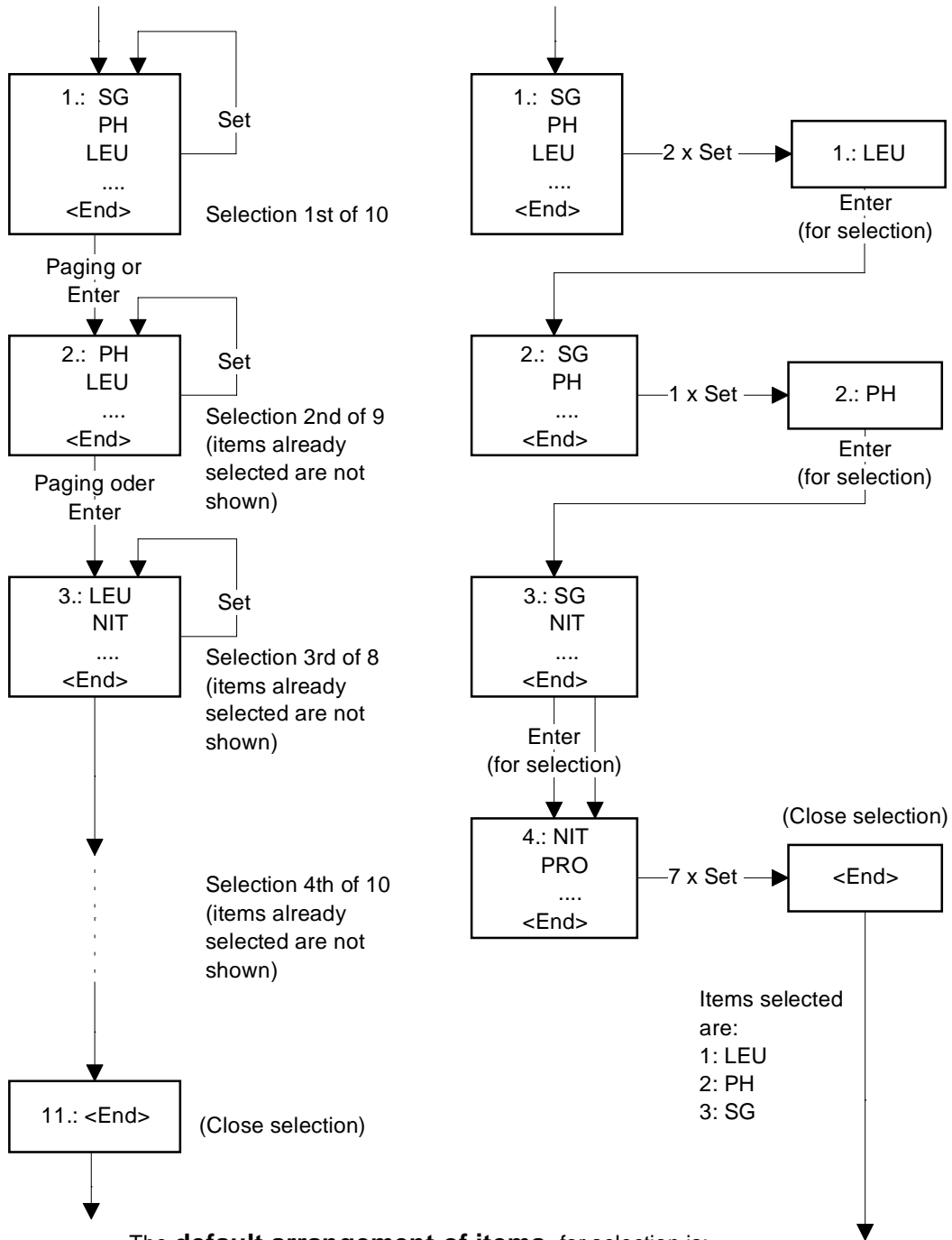

11. Software

11.3 Service/Status Software

Further information see Chapter 7.

11.4 Software update

There are two possibilities to install software updates:

- Load down from the two delivered chip cards
- Loading via service mode with the printer interface

11.4.1 Software update via chip cards

Roche Mannheim distributes new versions of software, and software updates, on two chip cards. To install or update software, proceed as follows:

Switch off power at the AC power adapter.

Insert Chip Card 1 in the program chip card slot (Fig. 61).

Switch power on again at the AC power adapter. You see displayed:

Press **<Enter>** to start the software update, or any other key to cancel.

The software loaded in the analyzer is cleared:

When the software is loading from Chip Card 1, the status LED flashes red and you see displayed:

Remove Chip Card 1 and insert Chip Card 2 in the program chip card slot (Fig. 61) when you see displayed:
The status LED is red.

Press **<Enter>** when you see the message:

When the software is loading from Chip Card 2, the status LED flashes red and you see displayed:

You briefly see the message:

Remove Chip Card 2 when you see displayed:

The software version number of the newly loaded software is displayed briefly.



Fig. 61

SW update ?

"Do you wish to perform a software update?"

erasing Program

"The old software is being erased"

loading Program

"Chip card 1 is being loaded"

Insert Card 2

"Insert chip card 2"

Load: <ENTER>

"Chip card 2 can be loaded"

loading Program

"Chip card 2 is being loaded"

Please Wait

"Please Wait"

Remove Chipcard

"Remove chip card 2"

SW.Vers. x x.xx

"Version number of the loaded software"

11. Software

Customer setting

"Restore the existing customer setting"

Default settings

"Restore the default settings"

Are you sure ?

"Request for confirmation of settings"

Please Wait

"Please Wait"

Self-Check

"Self-check running"

READY - <START>

"The analyzer is ready to measure"

You then see displayed:

Press **<Set>** to select one of the two display screens:

or

When you see "Default settings" displayed, all of the analyzer's settings will be restored to the factory defaults.

Press **<Enter>** to confirm your selection. You see displayed:

Press **<Enter>** to acknowledge the message or any other key to cancel.

While the settings are loading, you see displayed:

When the settings are complete, the analyzer carries out a new self-check.

On completion of a software update, the analyzer resumes Ready Mode.

When a software update is carried out, the results memory, error memory (for service purposes) and calibration values are cleared and the sequence number is set to 1. After the software update, a calibration must be performed. In this case the calibration cannot be avoided by pressing **<Start>**.

11.4.2 Software update via printer interface

Software updates via the interface are carried out in the Service Mode by means of a terminal program (e.g. Telix). For this purpose, a service PC is connected to the printer interface of **Miditron® Junior II** by means of a null modem cable.

Connection set-up:

Terminal program, PC interface

Baudrate: 9600

Parity: OFF

Data: 8 bit

Stopbit: 1

Protocol: ASCII

Control: Xon/Xoff

For a faster software update via the printer interface it is advisable to change the baudrate configuration of the service PC:

Baudrate: 19200

11. Software

SET=Protocol

"Analyzer is in the Service Mode"

Call the Service Mode (see Chapter 7). The display will then read:

Inquire the current software version, date, time and error number via a return from service PC to the analyzer.

Miditron® Junior II will answer to the terminal program:

VER y xx.xx	Program-No. Y=1 (International) Program-N0. Y=2 (USA) Software-Version X.X
DAT tt.mm.yy hh:mm	Date and time
ENR xxx	Error number (0 = no error)

Table: tab-9e

SW update ?

"Software update can be selected"

Enter the keyword "**PW3308**" via the terminal program. The display reads:

Source: PC

"Software update via upload can be selected"

Press any key to cause the analyzer to change to the "Software-Update" mode. Press **<Set>** until the following is displayed:

erasing Programm

"Old software is erased"

Press **<Enter>** to start the software update. The display reads:
The existing software is erased.

Break: no Update

"Software update was aborted"

The software update can be aborted by pressing **<Enter>**. The display reads:
If the existing software has not been deleted, press **<Set>** to cause the analyzer to change to the "Source: PC" display.

Send 1. File

"The first file is sent"

The three hex files juup.h00, juup.h01 and juup.h02 are transferred one after the other via upload. The display will always read the number of the file that is being transferred at a time.

loading Program

"The file is being sent"

Send 2. File

"The second file is sent"

The software update can be aborted with **<Set>** or Power Off/On. The display will then read again "SW update ?".

11. Software

Customer setting

"Restore the existing customer setting"

Default settings

"Restore the default settings"

Once the last file has been sent, the display reads:
Press **<Set>** to select one of the two display readings:

or

When "Default settings" is selected, all instrument settings will be reset to factory default settings.
Acknowledge the desired setting by pressing **<Enter>**.

For structural software updates (change in the version number before the decimal point) there is no optional choice. In this case, only the standard setting is available, as data areas or data structures might have changed.

After an update, the analyzer performs a selftest, deletes the results and resets the sequence number to 0. Then calibration is requested, before it changes to the Normal Mode.

If an error is detected in the course of a software update, an "error no. xx" (xx=1...12) is displayed. A description of the error codes is given in Chapter 13.

Attention: If the previous software has been deleted, it will be necessary to load an update. Otherwise the analyzer will not be operational.

11. Software

Flow Diagram of the SW-update Printer Interface

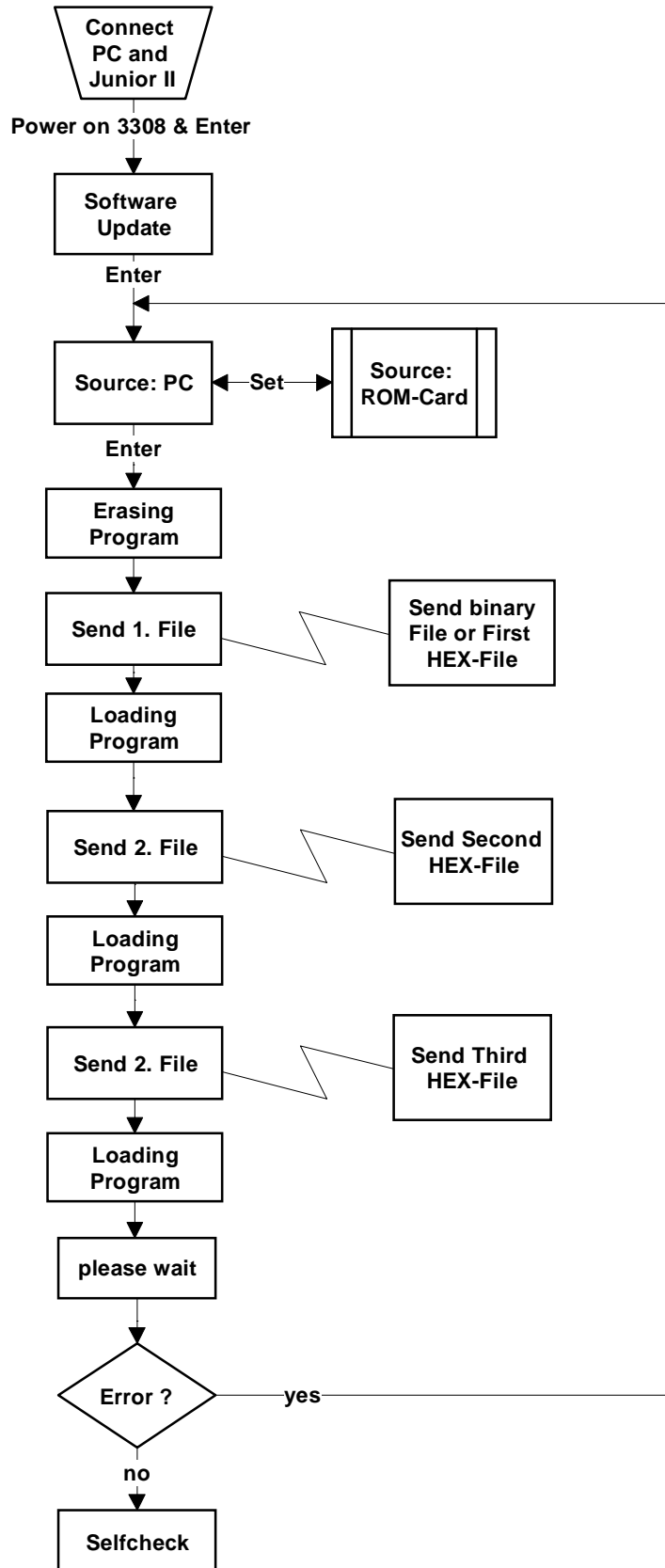

11. Software

11.5 Loading instrument settings via Download

All instrument settings, variable parameters as well as the texts can be downloaded via the printer interface. To do so, edit an INI-file in the ASCII mode.

Sections are described via keywords in square brackets (e.g. [Setup]).

Loading of the INI-file via the interface takes place in the Service Mode by means of a terminal program (e.g. Telix). For this purpose, the service PC is connected to the printer interface of **Miditron**® Junior II by means of a null modem cable.

Connection set-up:

Terminal program, PC interface

Baudrate: 9600

Parity: OFF

Data: 8 bit

Stopbit: 1

Protocol: ASCII

Control: Xon/Xoff

SET=Protocol

"Analyzer is in the Service Mode"

SET=INI-Download

"INI-Download can be selected"

Communicating

"Analyzer is ready to communicate"

Call the Service Mode (see Chapter 7). The display reads:

Press **<Paging>** to select the display reading:

Press **<Set>** to select the INI-Download function.

When the analyzer is ready to communicate, the display reads:

The INI-file can then be transferred from the service PC to **Miditron**® Junior II.

Downloading is terminated with EOF (End of File) or by pressing **<Paging>**.

11. Software

11.5.1 Specification of the INI-file

- ; identification: '[' first position, ']' last position
- ; parameter: parameter name, '=', parameter; upper/lower case printing allowed (except for texts)
- ; empty lines allowed (CR/LF)
- ; each parameter must be preceded by the appropriate block ID
- ; a semicolon in any position marks the beginning of a comment
- ; comments are valid to the end of the line
- ; blanks outside quotation marks and tabulators are ignored (to be erased during loading)
- ; texts may be within "\"" (but need not)
- ; texts that include blanks must be within "\""
- ; '###' in any position stand for End of File indentifiers
- ; each parameter must be entered in a new line
- ; after an INI-file transfer, errors are retransferred in an "error in line n: error description" format
- ; via the interface

[SETUP]

- ; parameters in the SETUP block can also be entered individually
- LANGUAGE=DEUTSCH ; DEUTSCH/FRANCAIS/ESPANOL/ITALIANO/ENGLISH
- TIMEFORM=24 ; 12/24
- TIME=14:34 ; Format: hh:mm (24 hour format only)
- DATEFORM=DMY ; DMY/MDY/YMD
- DATE=17.02.97 ; Format: dd.mm.yy oder dd.mm.yyyy)
- HOST=OFF ; ON/OFF
- PRINTER=ON ; internal printer ON/OFF
- DOUBLE=OFF ; double printout ON/OFF
- EXT_PRINTER=OFF ; ON/OFF
- IDLEN=13 ; Length Patld: 10/13
- COLOR=OFF ; OFF/MANU/AUTO3/AUTO4/AUTO5
- CLARITY=OFF ; ON/OFF
- STRIPTYPE=C10M ; C8M/C9M/C10M
- UNITS=CONV_ARB ; CONV/SI/ARB/CONV_ARB/SI_ARB
- FLAGS=DEFAULT ; OFF/DEFAULT
- MICRO=NOSPACE ; NOSPACE/SPACE
- MEMORY=IGNORE ; IGNORE/FULL
- MODE=NORMAL ; NORMAL/ACCEL/FAST
- REPRINT=LAST_RESULT ; LAST_RESULT / LAST_SERIES / ABNORMAL / NORMAL / TODAY / All

[PRINT_PARAM]

- ; always input PRINT_PARAM block completely; observe sequence (1 .. End)
- ; missing parameters will not be printed
- 1=SG ; SG/PH/LEU/NIT/PRO/GLU/KET/UBG/BIL/ERY
- 2=LEU
- 3=pH
- 4=NIT
- 5=ERY
- 6=BIL

[COLOR]

- 1=yellow ; texts in the sequence to be displayed
- 2=darkyellow ; observe sequence (1..End)
- 3=green ; texts are shortened to12 characters
- 4=brown ; if texts are shortened, a warning

11. Software

5=red ; is displayed
6=other

[CLARITY]
1=clear
2="leicht trüb" cloudy ???? ; texts in the sequence to be displayed
3="stark trüb" very cloudy ???? ; observe sequence (1..End)
4=mucous ; texts are shortened to 12 characters
5=sanguinous

[HEAD]
1="line 1" ; 2 lines for headlines for result printout via ext. printer
2="line 2" ; up to 40 characters each
; 1st line obligatory, 2nd line optional

[PRINTER] ; ASCII codes (decimal) of characters to be sent (max. 10 codes). Except for POST code = 0 allowed.
INI=27,64 ; initialization (<ESC>@)
LEN=27,67,0,9 ; page length
LM=27,108,15 ; left margin
MODE=27,120,1 ; NLQ mode
TYPE=27,107,1 ; NLQ fonttype
CPI=27,80 ; Pica character width
POST=13,10 ; after each result (CR,LF), code 0 not allowed
RESPP=1 ; results per page (0=no FF)

[KONZ_LEU]
; texts in the currently selected language are changed
; the language can also be selected in the current INI-file (position before text change)
1=neg,neg,neg ; texts for the individual concentration steps
2=25,25,+ ; text hyphenation conventional, SI, arbitrary by ‘;
3=50,50,++ ; 1st step text only (max. 11, 11, 5 characters)
4=75,75,+++ ; from 2nd step numbers in ascending order (conv,si)
; and text for arbitrary (max. 4, 4, 5 characters)
Flagging=2 ; concentration step for flagging
; 0: no flagging
; 1: not allowed (to be converted in no flagging)
; 2: flagging from 2nd positive step
%R=85,65,59,48 ; % remission (descending, up to 2 characters each)

[KONZ_ERY]
1=neg,neg,neg
2=10,10,1+
3=25,25,2+
4=50,50,3+
5=150,150,4+
6=250,250,6+
Flagging=1
%R=60,53,38,26,27 ; % remission; for ERY: 26 must occur;
; remission borders up to and including 26: borders orange
; remission borders beyond 26: borders green

; End of File identification

Messages after the Download INI-file are printed in English.

11. Software

11.6 Saving instrument settings via Upload

All instrument settings, variable parameters as well as the texts can be saved to the service PC by means of an upload via the printer interface.

Saving via the interface takes place in the Service Mode by means of a terminal program (e.g. Telix). For this purpose, the service PC is connected to the printer interface of **Miditron® Junior II** by means of a null modem cable.

Connection set-up:
Terminal program, PC interface
Baudrate: 9600
Parity: OFF
Data: 8 bit
Stopbit: 1
Protocol: ASCII
Control: Xon/Xoff

SET=Protocol

"Analyzer is in the Service Mode"

SET=Save INI

"Save INI can be selected"

Communicating

"Analyzer is ready to communicate"

Call the Service Mode (see Chapter 7). The display reads:

Press **<Paging>** to select the display reading:

Press **<Set>** to select the Save INI function.

When the analyzer transfers the data to the service PC the display reads:

Data transfer is terminated with EOF (End of File) or by pressing **<Paging>**.

12. Interface

12.1 Host Interface

The **Miditron**[®] Junior II appliance has a serial interface connection to the customer's laboratory EDP system, hereinafter called the „Host“. These specifications are concerned with the exchange of data, its activation, protocol formats and timing.

These specifications are based on the host connection of the **Miditron**[®] Junior II appliance

The **Miditron**[®] Junior II provides the following data: Date and time of measurement, the findings obtained from the urine test strip and sequence number of the measurement.

The **Miditron**[®] Junior II appliance does not handle patient identification.

Data transfer is thus restricted to upload functions.

Uploading is possible only after a measurement or at the end of a measurement series.

The customer initiates transfer by pressing the reprint/send key. The appliance setup must be set to "Host/PC On" to this end. All the findings which have not previously been transmitted are then transmitted.

The Host itself cannot request the measurement results.

12. Interface

12.2 Character definitions, representation conventions

Table for Character definitions:

No.	Abb.	Meaning	Representation
1	CR	ENTER	0D ₁₆
2	LF	Line-Feed	0A ₁₆
3	chr	ASCII-character to DIN 66003 Table 1 (International Reference version)	20 ₁₆ to 7D ₁₆
4	txt	Letter characters or spaces	20 ₁₆ , 41 ₁₆ to 7D ₁₆
5	num	Numbers/ punctuation marks	30 ₁₆ to 39 ₁₆ and ",", ";", ":", ".", "-", "_", "/", "\\", "(", ")", "+", "=", " ", "*".
6	STX	Start of protocol	02 ₁₆
7	ETX	End of protocol	03 ₁₆
8	SPE	"Specific Sample" : Data	3B ₁₆
9	SPE-E	"Specific Sample" : E = Result	3B ₁₆ 45 ₁₆
10	SPE-D	"Specific Sample" : D = color + turbidity	3B ₁₆ 44 ₁₆
11	SPE-A	"Specific Sample" : A = Pat. ID. Download	3B ₁₆ 41 ₁₆
12	SPM	"Specific Multiple"	3C ₁₆
13	ANY	Any Inquiry	3E ₁₆
14	MOR	More	3E ₁₆
15	REP	Repeat	3F ₁₆
16	END	End	3A ₁₆
17	SP	Space	20 ₁₆

Table: tab-12e

Table for Representation conventions:

1	' xy '	All the characters between the inverted commas are transmitted as ASCII characters, spaces included
2	20xSP	20 spaces are transmitted consecutively.
3	3xnum	3 number characters are transmitted consecutively.
4	25x-	The character "-" is transmitted 25 times consecutively.
5	10xtxt	10 text characters are transmitted.
6	10xchr	10 characters are transmitted according to character definition 3 (see above).

Table: tab-11e

The numbers in this convention agreement are intended as examples only.

12. Interface

12.3 Protocols

No protocol is longer than 255 bytes. If a data field exists, it will consist of a function code, one space (or „Spare“, to use Hitachi's nomenclature, space = 20₁₆) and the data in question. The length of the block is neither coded nor transmitted. Protocol length is clearly defined in these specifications and so can be checked easily. The frame code indicates the purpose and task of the block. Much of this is purely „useful information“ and must be interpreted as a command or request.

Each act of communication takes the form of a cycle: The **Miditron**[®] Junior II transmits and awaits a reply. The **Miditron**[®] Junior II analyses communication status. It measures the Host's response times, checks block storage and the frame code of the replies. Erroneous protocols are not accepted. (Erroneous here means that at least one of the before mentioned tests does not produce the result expected; the cause may be a software error in the Host or a disturbance in the line). The Host must also check: Is the frame code permissible and block storage okay?

The handshake is represented as an interaction diagram and as a status transition diagram.

Every protocol transferred is transferred as a block. The blocks from Host and **Miditron**[®] Junior II are put together as follows:

12. Interface

Table for Protokol structure:

Pat Id length of 10 characters

Transmitter	Header				Data field					Trailer			Σ Bytes
	SC	FK	FC	SP	Pat-ID	Seq.-No.	Date	Time	Data	EC	CS	CR	
Host	STX	SPE	A	SP	10 chr +SP					ETX	CS1,2	CR	19
Miditron	STX	SPE	D	SP	10 chr +SP	5 num. +SP	8 num. +SP	5 num. +SP	38 char	ETX	CS1,2	CR	78
Miditron	STX	SPE	E	SP	10 chr +SP	5 num. +SP	8 num. +SP	5 num. +SP	196 char	ETX	CS1,2	CR	236
Miditron	STX	SPM								ETX	CS1,2	CR	6
Miditron	STX	ANY								ETX	CS1,2	CR	6
HOST	STX	MOR								ETX	CS1,2	CR	6
Miditron/ HOST	STX	REP								ETX	CS1,2	CR	6
Miditron/ HOST	STX	END								ETX	CS1,2	CR	6

Table: tab-10e

Pat Id length of 13 characters

Transmitter	Header				Data field					Trailer			Σ Bytes
	SC	FK	FC	SP	Pat-ID	Seq.-No.	Date	Time	Data	EC	CS	CR	
Host	STX	SPE	A	SP	13 chr +SP					ETX	CS1,2	CR	22
Miditron	STX	SPE	D	SP	13 chr +SP	5 num. +SP	8 num. +SP	5 num. +SP	38 char	ETX	CS1,2	CR	81
Miditron	STX	SPE	E	SP	13 chr +SP	5 num. +SP	8 num. +SP	5 num. +SP	196 char	ETX	CS1,2	CR	239
Miditron	STX	SPM								ETX	CS1,2	CR	6
Miditron	STX	ANY								ETX	CS1,2	CR	6
HOST	STX	MOR								ETX	CS1,2	CR	6
Miditron/ HOST	STX	REP								ETX	CS1,2	CR	6
Miditron/ HOST	STX	END								ETX	CS1,2	CR	6

Table: tab-33e

12. Interface

The „protocol header“ or just „header“ means the start character, the frame code, function and the spare which follows (columns 1, 2, 3 and 4). The „protocol trailer“ or just „trailer“ consists of the end character, the test bytes and return (columns 10, 11 and 12).

The frame codes have the following meanings:

END	=	3A ₁₆	=	‘.’		
SPE	=	3B ₁₆	=	‘;’	MOR	= 3E ₁₆ = ‘>’
SPM	=	3C ₁₆	=	‘<’	REP	= 3F ₁₆ = ‘?’

12. Interface

12.4 Upload timing and handshake

The protocols are identified by abbreviated codes on the arrows symbolizing the direction of transfer. Those protocols which appear more than once are executed more than once.

Miditron® Junior II (Master)

HOST (Slave)

Start communication after pressing reprint/send key: Host is asked whether it is ready to receive

/SPM/ —————>

<—————/MOR/ - Reply

If disturbance or not ready to receive, no reply.

If no reply (15 s time out):

/SPM/ —————>

as above

If disturbance:

/REP/ —————>

Repeat above command; no command if disturbance

Repeat /SPM/, /REP/ max.4 times then no more communication.

If received /MOR/

/SPE/-E/ —————>

<—————/MOR/

<—————/REP/

If received
If disturbance

If /MOR/ received, transmit color + turbidity

/SPE/-D/ —————>

as above

If /REP/ received, transmit previous finding

/SPE/-E/ —————>

as above

If no reply (15 sec. time out):

/SPM/ —————>

as above

If disturbance:

/REP/ —————>

as above

Repeat /SPM/, /REP/ max. 4 times, then no more communication.

If /MOR/ received:

/SPE/-E —————>

<—————/MOR/

<—————/REP/

If received
If disturbance

etc. until

End of communications:

/END/ —————>

(No handshake for /END/)

„/SPE/-D/ and SPE-E“ is explained in more detail in Section 12.6 All data sets have the frame code /SPE/. „Data“ contains findings which have not yet been sent after a correctly received /MOR/ or, in the case of /REP/, a repeat of the last findings to be sent. If the transmission of /SPM/ or /REP/ by the **Miditron® Junior II** is necessary between two /SPE/ data sets, the last findings will be repeated after the next /MOR/.

12. Interface

Status Transition Diagram Host Communications (Upload)

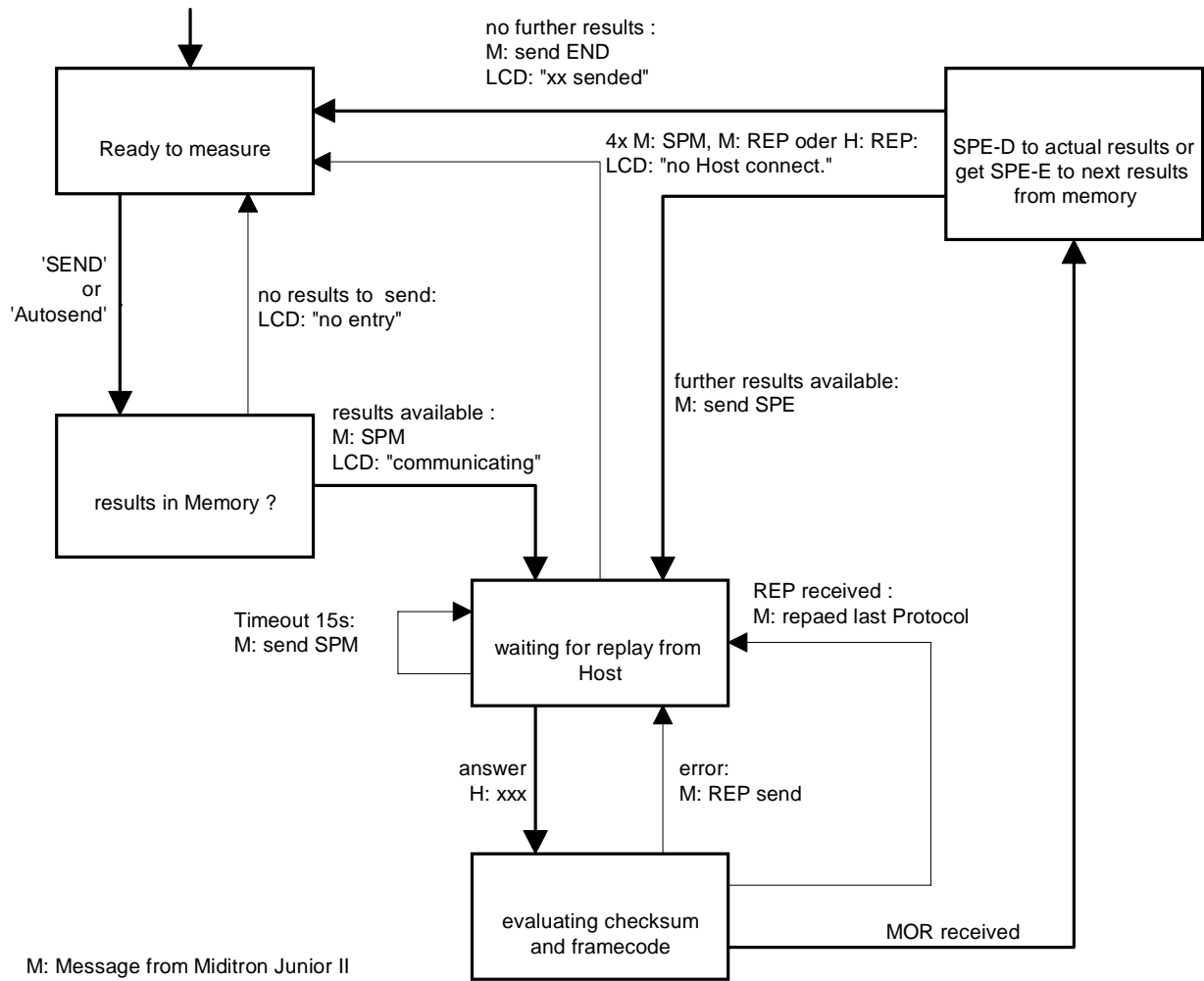

M: Message from Miditron Junior II
 H: Message from Host
 bold lines: normal communication without error

12. Interface

12.5 Download timing and handshake

Miditron® Junior II (Master)

HOST (Slave)

Start communication after pressing "receive list": Miditron is asked whether Host is ready to send

/ANY/ —————>

<—————/SPA-A/-

Reply Pad ID

If disturbance or not ready to receive, no reply.

If no reply (15 s time out):

/ANY/ —————>

as above

If disturbance:

/REP/ —————>

Repeat above command; no command if disturbance

Repeat /ANY/, /REP/ max.4 times then no more communication.

If received /SPE-A/

/ANY/ —————>

<—————/SPE-A/

<—————/REP/

If received next Pad ID
If disturbance

If /REP/ received, transmit previous finding

<—————/END/

When all Pad Id's transmitted

Working list is full

/END/ —————>

No replay

If /REP/ received

/ANY/ —————>

as above

No replay (15 sec. time out):

/ANY/ —————>

as above

disturbance:

/REP/ —————>

as above

Send /ANY/ after disturbance or /REP/ max. 4 times: stop communication

12. Interface

Status Transition Diagram Host Communications (Download)

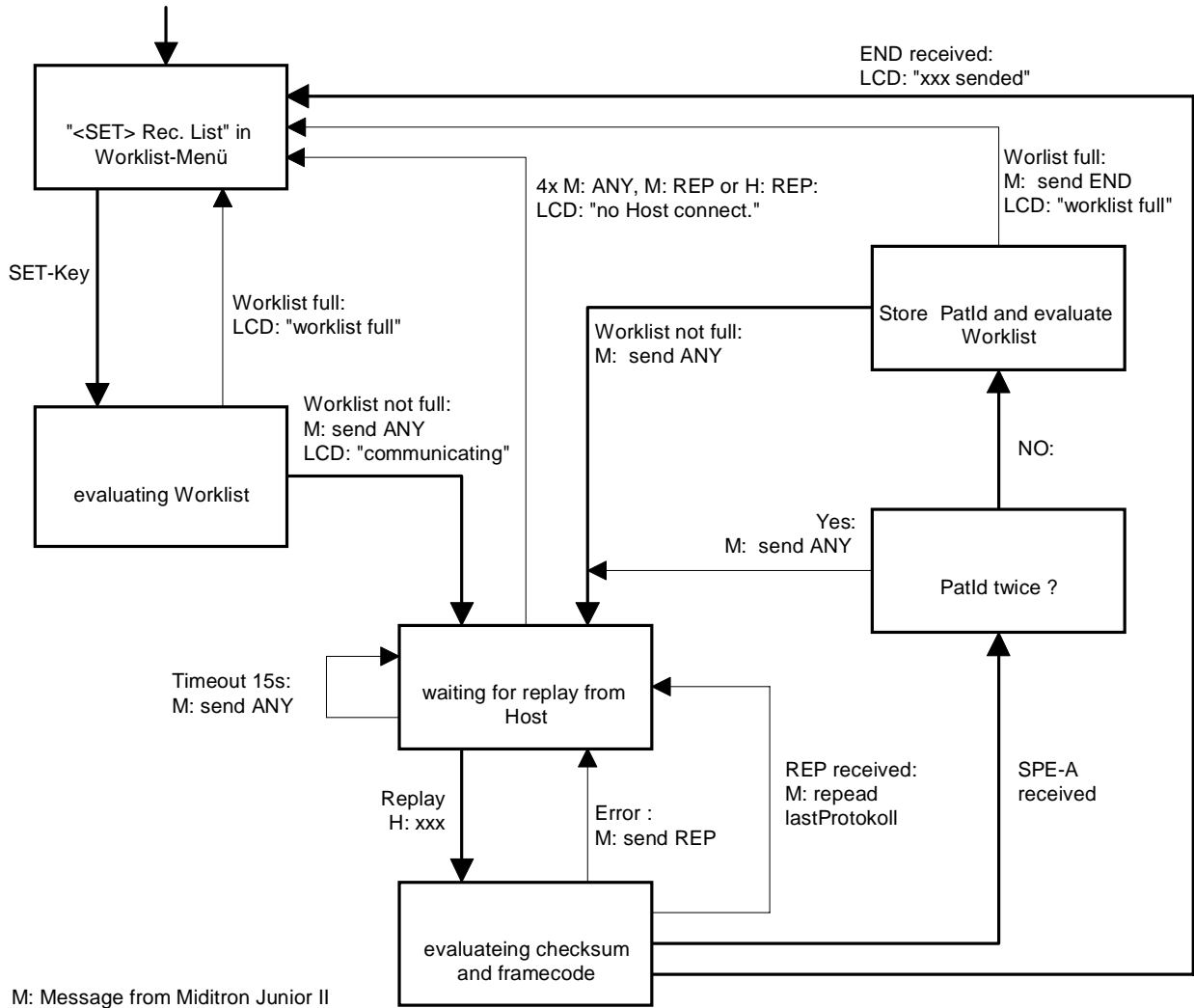

M: Message from Miditron Junior II
 H: Message from Host
 bold lines : normal Communication without error

12. Interface

12.6 Protocol structure

12.6.1 Protocol "/REP/": Repeat request

Transmitter	HOST/ Miditron [®] Junior II	
Byte No.:	Meaning	Comments
1	STX	Start character
2	REP	Frame code; „repeat“;
3	ETX	End code
4	CS 1	Checksum 1
5	CS 2	Checksum 2
6	CR	Return

12.6.2 Protocol "/SPM/": Start Communication

Transmitter	Miditron [®] Junior II	
Byte No.:	Meaning	Comments
1	STX	Start character
2	SPM	Frame code
3	ETX	End code
4	CS 1	Checksum 1
5	CS 2	Checksum 2
6	CR	Return

12.6.3 Protocol "/MOR/": Receipt confirmed/ Request for next set

Transmitter	Host	
Byte No.:	Meaning	Comments
1	STX	Start character
2	MOR	Frame code
3	ETX	End code
4	CS 1	Checksum 1
5	CS 2	Checksum 2
6	CR	Return

12.6.4 Protocol "/END/": End of communication

Transmitter	Miditron [®] Junior II	
Byte No.:	Meaning	Comments
1	STX	Start character
2	END	Frame code
3	ETX	End code
4	CS 1	Checksum 1
5	CS 2	Checksum 2
6	CR	Return

12. Interface

12.6.5 Protocol "/SPE-D/ + Data": Data protocol color + turbidity

Transmitter: Miditron® Junior II			
Byte Nr. for 10	Byte Nr. for 13	meaning	comment
1	1	STX	Start character
2	2	SPE	Frame character; 3B ₁₆ ; ‘;’
3	3	‘D’	Block D; ‘D’ = 44 ₁₆
4	4	SP	Space
5 .. 14	5 .. 17	Pat-Id	length 10 or 13, as chosen in Setup
15	18	SP	Space
16 .. 20	19 .. 23	Seq. Nr	sequenz -Number of result
21	24	SP	Space
22 .. 29	25 .. 32	date	Datum of result
30	33	SP	Space
31 .. 35	34 .. 38	time	time of result
36	39	SP	Space
37 .. 54	40 .. 57	color	color left handed orientated
55	58	SP	Space
56 .. 73	59 .. 76	turbidity	turbidity left handed orientated
74	77	SP	Space
75	78	ETX	End character
76	79	CS1	Checksum 1
77	80	CS2	Checksum 2
78	81	CR	Return

12.6.6 Protocol "/SPE-E/ + Data": Data protocol results

Transmitter: Miditron® Junior II			
Byte Nr. for 10	Byte Nr. for 13	meaning	comment
1	1	STX	Start character
2	2	SPE	Frame character; 3B ₁₆ ; ‘;’
3	3	‘E’	Block D; ‘E’ = 45 ₁₆
4	4	SP	Space
5 .. 14	5 .. 17	Pat-Id	length 10 or 13, as chosen in Setup
15	18	SP	Space
16 .. 20	19 .. 23	Seq. Nr	Sequenz-Number of result
21	24	SP	Space
22 .. 29	25 .. 32	Datum	Datum of result
30	33	SP	Space
31 .. 35	34 .. 38	time	time of result
36	39	SP	Space
37 .. 232	40 .. 235	Data	results
233	236	ETX	End character
234	237	CS1	Check sum 1
235	238	CS2	Check sum 2
236	239	CR	Return

12. Interface

12.6.7 Protocol "/SPE-A/ + Pat-Id.": Data protocol Pat-Id.

Transmitter: Byte Nr. for 10	HOST Byte Nr. for 13	meaning Pat-Id-length	explanation
1	1	STX	Start character
2	2	SPE	Frame character; 3B ₁₆ ; ‘;
3	3	‘A’	Block D; ‘D’ = 41 ₁₆
4	4	SP	Space
5 .. 14	5 .. 17	Pat-Id	length 10 or 13, as chosen in Setup
15	18	SP	Space
16	19	ETX	End character
17	20	CS1	Check sum 1
18	21	CS2	Check sum 2
19	22	CR	Return

12.7 Format of results-data :

Byte Nr. of 10-Id	Byte Nr. of 13-Id	field-length	explanation
37... 49	40... 52	13	SG + 5xBef + 6xSP
50... 60	53... 63	11	PH + 3xBef + 6xSP
61... 80	64... 83	20	LEU + 11xres + 5xArb + SP
81... 92	84... 95	12	NIT + 03xres + 5xArb + SP
93...112	96...115	20	PRO + 11xres + 5xArb + SP
113...132	116...135	20	GLU + 11xres + 5xArb + SP
133...152	136...155	20	KET + 11xres + 5xArb + SP
153...172	156...175	20	UBG + 11xres + 5xArb + SP
173...192	176...195	20	BIL + 11xres + 5xArb + SP
193...212	196...215	20	ERY + 11xres + 5xArb + SP
213...232	216...235	20	NAG + 17xSP

11x = number of bits
 res = result in Con. or SI units
 Arb = Arbitrary units
 SP = Space

12.7.1 Structure of results-data Programm-1 (International) :

example : setting “conventional” or “conv & Arb”; Programm-1

Byte Nr. for 10-Id	Byte Nr. for 13-Id	field-length	example of results
37... 49	40... 52	13	SG 1.030 *****
50... 60	53... 63	11	PH **7 *****
61... 80	64... 83	20	LEU *****neg *****
81... 92	84... 95	12	NIT neg *****
93...112	96...115	20	PRO ***75*mg/dl ***+*

12. Interface

113...132	116...135	20	GLU 1000mg/dl ++++
133...152	136...155	20	KET 5mg/dl ++++
153...172	156...175	20	UBG 4mg/dl ++++
173...192	176...195	20	BIL 3mg/dl ++++
193...212	196...215	20	ERY 25ul ++++
213...232	216...235	20	NAG ++++

example : setting "SI" or "SI & Arb"; Programm-1

Byte Nr. for 10-Id	Byte Nr. for 13-Id	field-length	example of results
37... 49	40... 52	13	SG 1.030 ++++
50... 60	53... 63	11	PH 7 ++++
61... 80	64... 83	20	LEU 500/ul ++++
81... 92	84... 95	12	NIT pos pos
93...112	96...115	20	PRO 0.75g/l ++++
113...132	116...135	20	GLU 56mmol/l ++++
133...152	136...155	20	KET 0.5mmol/l ++++
153...172	156...175	20	UBG 68umol/l ++++
173...192	176...195	20	BIL 50umol/l ++++
193...212	196...215	20	ERY 25ul ++++
213...232	216...235	20	NAG ++++

example : setting "arbitrary"; Programm-1

Byte Nr. for 10-Id	Byte Nr. for 13-Id	field-length	example of results
37... 49	40... 52	13	SG 1.030 ++++
50... 60	53... 63	11	PH 7 ++++
61... 80	64... 83	20	LEU ++++
81... 92	84... 95	12	NIT pos pos
93...112	96...115	20	PRO ++++
113...132	116...135	20	GLU ++++
133...152	136...155	20	KET ++++
153...172	156...175	20	UBG ++++
173...192	176...195	20	BIL ++++
193...212	196...215	20	ERY ++++
213...232	216...235	20	NAG ++++

12. Interface

12.8 Procedures for checking test bytes

12.8.1 European language variations of Miditron® software: LRC test bytes

The LRC test bytes are a Longitudinal Redundancy Check - a kind of longitudinal parity test of the bits contained in the data protocol. The procedure is quite simple: Byte for byte, the protocol is linked bit by bit to XOR. The resulting byte is then split into two bytes (to avoid the occurrence of control characters) and attached to the protocol.

$$\text{LRC-Byte} = \text{Byte1 XOR Byte2 XOR Byte3 XOR Byte last}$$

$$\text{LRC1-Byte} = \text{high-Nibble (shifted by 4 bits) of the LRC-Byte OR } 30_{16}$$

$$\text{LRC2-Byte} = \text{low-Nibble of LRC-Byte OR } 30_{16}$$

Example:

	Bit-No.								
	8	7	6	5	4	3	2	1	
1	0	1	1	0	0	0	1	0	
2	0	0	0	0	0	0	1	1	
3	0	0	1	1	0	1	1	0	
4	0	0	1	1	1	0	1	0	
5	0	0	1	1	1	1	1	0	
<hr/>									
LRC-Byte	0	1	0	1	0	0	1	1	
<hr/>									
high-Nibble	0	1	0	1					
low-Nibble	0	0	1	1					
LRC 1 - Byte =	0	0	1	1	0	0	0	0	/* 30 ₁₆ */
OR	0	0	0	0	0	1	0	1	/* high-Nibble */
<hr/>									
	0	0	1	1	0	1	0	1	
<hr/>									
=====									
LRC 2 - Byte =	0	0	1	1	0	0	0	0	/* 30 ₁₆ */
OR	0	0	0	0	0	0	1	1	/* low-Nibble */
<hr/>									
	0	0	1	1	0	0	1	1	
<hr/>									
=====									

All bytes beginning with STX (inclusive) up to ETX (inclusive) are taken into account in the formation of the LRC. Some laboratory computers have a manufacturer-specific transmit/receive driver implemented which cuts off the STX in protocols and does not allow it to get into the overriding user software. In this case, the user must first switch off block testing in the Host.

urther examples of ASCII representation:

MOR-Protocol: ☺>♥3?

REP-Protocol: ☺?♥3>

SPM-Protocol: ☺<♥3=

12. Interface

12.8.2 American/Canadian language version of Miditron® Junior II software:

Check total

The check total is reached simply by adding together the bytes to be transferred, the individual bytes being interpreted as positive, whole numbers. STX, BTX and CR are not included in the addition. The result of the addition is taken as modulo 256. The resulting number can be represented by a single byte. The two half-bytes of this number are represented as hexadecimal figures ("0".."9", "A".."F"). Initial zeros are included.

$$CS = (\text{Byte}_2 + \text{Byte}_3 + \dots + \text{Byte}_{\text{Length}-4}) \text{ modulo } 256$$

$$\begin{aligned} \text{CS1-Byte} &= (CS / 16) + 30_{16} && \text{for } (CS / 16) \leq 9 \\ &= (CS / 16) + 37_{16} && \text{for } (CS / 16) \geq 10 \end{aligned}$$

$$\begin{aligned} \text{CS2-Byte} &= (CS \text{ modulo } 16) + 30_{16} && \text{for } (CS \text{ modulo } 16) \leq 9 \\ &= (CS \text{ modulo } 16) + 37_{16} && \text{for } (CS \text{ modulo } 16) \geq 10 \end{aligned}$$

Example: MOR-Protocol

$$\begin{array}{l} \text{STX,'>',ETX,'3E',CR} \\ 02\ 3E\ 03\ 33\ 45\ 0D_{16} \end{array} \quad \text{with} \quad CS = 62 = 3E_{16}$$

Further examples of ASCII-representation:

MOR-Protocol: ☺>♥3E

REP-Protocol: ☺?♥3F

SPM-Protocol: ☺<♥3C

12. Interface

12.8.3 Automatic adaption to the test procedure used by the host

Miditron[®] Junior II is in a position to adapt itself automatically to the test procedure used by the host. If an error is discovered when checking the test bytes of the receive protocol, the check will be continued using the algorithms of the alternative procedure. If, using the alternative test procedure, the test bytes are recognized as correct, this procedure will be used for all protocols in future. This new setting is retained even after the appliance has been switched off. If the alternative procedure does not recognize any correct test bytes either, an REP protocol is transmitted and there is no change of test procedure.

If, upon startup (i.e. the first time **Miditron**[®] Junior II is connected up to the host) , two different procedures are set, the host must reply to the SPM from **Miditron**[®] Junior II with an REP or MOR and the relevant test bytes.

Example:

Miditron [®] Junior II	Host	Remarks:
/SPM/ —————>		(with LRC)
<————— /MOR/		(with check total)
/SPE/+data —————>		(with check total)
		Hencefort, check-total permanently set as the test procedure in Miditron [®] Junior II
or	<————— /MOR/	(with LRC)
	<————— /REP/	(with LRC)
	/SPE/+data —————>	(with LRC)
		Hencefort, LRC permanently set as the test procedure in Miditron [®] Junior II
or	<————— /MOR/	(with check total)
	<————— /REP/	(with check total)
	/SPE/+data —————>	(with check total)
		Henceforth, check-total permanently set as the test procedure in Miditron [®] Junior II

etc.

13. Troubleshooting

The instrument contains software control functions which test the electronic hardware and peripherals after being switched on or after stand-by and which detect occurring errors during measurement. According to the importance of the error the just measured results are dismissed or in case of non-repairable errors (Major Error) the instrument changes to error condition. An error report is announced, in any case.

Occuring errors have been divided into 3 groups:

- error at self-test
- repairable errors during normal mode
- non-repairable errors during normal mode (Major Error)

13.1 Error at self-test

When starting the program, a hardware self-test is initiated. The following components are tested one after another:

- ROM
- EEPROM
- RAM
- Frequency Factor
- RTC
- Display
- Light Barrier
- Printer

All errors lead to a system stop with the exception of light barrier and printer. The occurred error is shown on the display, on the serial interface and printed via a 3-digit figure. The system stop allows a result printout via the <Reprint> key and a status protocol is printed.

The **ROM-test** creates a checksum of the total ROM and compares it to the saved value.

The **EEPROM-test** checks the data necessary for the operation of the instrument and its CRCs.

The **RAM-test** marks all memory cells with 00h, AAh, 55h and FFh and checks them. The RAM-test does not erase any information which means the data is reproduced after the test.

The **LEDs** and **frequency** factor are tested by initiating a 1 MHz bar and conducting a normal measurement cycle.

(Major Errors)

13. Troubleshooting

The SQW exit is activated at the **RTC-component** and therefore the command list of the RTC is checked. In addition, the condition of the RTC battery is checked via the VRT-flag.

When starting the **display test**, first of all an initialisation command is sent to the display. Is now the display not busy or is aborted with timeout, a display error occurs. After that the same procedure is repeated with a data byte. In case an unexpected light barrier signal occurs, the instrument first tries to move the measuring head to its reference position with timeout surveillance. After that the cross transport is moved to its reference position with timeout surveillance. When here a timeout occurs, the system is stopped.

The **printer test** checks the BUSY-signal of the printer with timeout. A non-printable figure is sent to the printer and the ACK signal is checked. The timeout has to be selected in a way that the Power on –test of the printer can still be completed (push LF when switching it on). In case an error occurs, this is only shown on the LCD. The system remains ready for measurement.

13.2 Repairable errors during normal mode

Repairable errors in the normal mode are operation errors, primary movement errors, count-errors and calibration errors.

Operation errors of the user are wrongly respectively not inserted strips during adjustment, calibration and measurements. These errors are detected. These errors are always shown on the display, on the HOST and printed in case of adjustment and calibration. After this a repetition of the action has to be offered to the user. During measurement, in abort is initiated.

Primary movement errors are timeout errors of the cross transport and step losses of the measuring head drive. Here the action is always stopped and it is tried to lead the instrument back to a defined condition via reference movements. The measurement results are dismissed.

Count errors occur when the measurement results are outside the valid value range. In this case, the measurement is invalid.

13. Troubleshooting

Calibration errors are deviations exceeding 10 % of the known remission values of the profile grey strips respectively exceeding 1 % of the previous calibration values. In case of an error, the user is asked to repeat the calibration.

In case of **printer errors** Printer Head Up and Printer Out of Paper the printout is stopped and an error is shown after the end of the measurement. After repair of the error the print continues.

13.3 Non-repairable errors during normal mode (Major Error)

Major errors are errors occurring during normal mode and which make a further correct measurement uncertain. These errors can be secondary movement errors, errors during PGA-value calculation and CRC errors of relevant data in the EEPROM. These errors lead to a system stop.

Secondary movement errors are errors occurring during reference movements after primary movement errors. Errors occurring during PGA-value calculation lead to the fact that the instrument is defective. CRC errors in the EEPROM exclude a correct function of the instrument as the instrument parameters are not guaranteed.

13. Troubleshooting

13.4 Errors during INI-file Download

Errors during INI-file download	
Message	Description
COMPLETED	download completedt
] expected	end of identification (section) missing
date expected (dd.mm.jj)	error in date setting
date format error	date format error
different number of steps	foncentration steps error
flaging exceeds number of steps	flagging exceeds number of steps
identity expected	identity expected
improper identity	improper identity
improper name of parameter	improper name of parameter
improper parameter	improper parameter
line ignored	parameter error, line ignored
missing parameter	parameter value missing
missing quotation mark or no string	string not detected
missing string	string too short or missing
no 26% range	26% range missing for ERY
no number	no number found
no parameter name	parameter name missing
number of steps must be 2 or more	number of steps too low
number too high	number of steps too low
parameter already exists	print parameter already exists
parameter 'ARB' missing	parameter 'ARB' missing
parameter no. xx expected	wrong sequence of parameters
parameter not allowed	parameter SG for C9M not allowed
parameter 'SI', 'ARB' missing	parameter 'SI', 'ARB' missing
parameter too long	parameter too long
string is shortened	headlines too long, are shortened
string too long	string too long
text missing	CONV, SI and ARB missing
time expected (hh:mm)	time missing
time format error	time format error
too few steps	too few steps
too many steps	too many steps
too many parameters	too many parameters
values have to fall	values have to fall
values have to rise	values have to rise
1 is not allowed, flaging is turned off	Improper flagging, is turned off

Table: tab-32e

13. Troubleshooting

13.5 List of all error codes

Display Messages	Description
"Self-Check"	self-test of the instrument
"Empty Waste Tray"	Cleaning device
"READY-<START>"	Ready for measurement normal mode
"ACC MODE <START>"	Ready for measurement accelerated mode
"FAST MODE<START>"	Ready for measurement fast mode
"Please Calibrate"	Request to calibrate instrument
"Recalibrate !"	Request to repeat calibration
"Insert Cal Strip"	Insert calibrat strip
"Press <Calibr.>"	Hit key <Calibrate> to start calibration
"Calibrating"	calibration is running
"Insert Adj.Strip"	Insert adjustment strip
"Adjusting ..."	Adjustment is running
"Prepare Strip"	Prepare new measuring strip
"Dip Strip"	Dip new measuring strip
"Insert strip"	Insert moistened measuring strip
"Memory !"	Memory almost full
"Clear Memory"	Memory full, measurement not possible
"No results"	Result memory empty
"Communicating"	Host transmission is running
"No host connect."	Timeout during host transmission
"Worklist full"	Worklist full (75 entries)
"Check Ranges"	Remission limit defective
"Check Setup"	Set-up adjustments lost
"Check Text"	Clients texts defective
"Wait printing"	Print running, please wait
"Cont. <Reprint>"	Is print stopped with <start>, hit <reprint> to restart printing
"ESC <Start >"	Stop print with <start> key
"Printer busy"	External printer busy
"Printer offline"	External printer CTS not set, printer offline
"out-of-paper"	Internal printer paper end
"Printer head-up"	Internal printer unlocked printing roll
"Printer defect"	Internal printer defective
"Head temperature"	Internal printer temperature of thermo printing head too high

Table: tab-21e

13. Troubleshooting

Repairable Error		
Error Code 1-99	Reason	What to do?
1	Step loss on measuring head transport	
2	Dark counts not within value range	
3	Difference counts too low	
4	Out of range	
5	Concentration range not chosable	
6	Light counts exceed value range	
7	One or more sollint-values are <60% or >80%	
10-45	1%-clause of calibration error = 10+(3*measuring field)+LED-Nr. (g,o,r)	- A second calibration strip has to be measured- Clean/ change reference field
50-85	10%-clause of calibration error = 50+(3*measuring field)+LED-Nr. (g,o,r)	- A second calibration strip has to be measured- Clean/ change reference field

Table: tab-22e

13. Troubleshooting

Positioning Error / Lightbarrier Error		
Error Code 100-199	Reason	What to do?
102	Timeout error of measuring head reference movement	- Check measuring head - Check light barrier- Perform adjustment procedure (see chapter 7)
103	Timeout error during movement from reference position	- Check measuring head- Check light barrier - Perform adjustment procedure (see chapter 7)
134	Timeout error during DC reference movement	- Check cross bar mechanism- Perform adjustment procedure (see chapter 7)
140	Step loss during RUN_IN	- Check/ change measuring head- Perform adjustment procedure (see chapter 7)
150	CRC of adjustment position incorrect	- Change CPU board- Perform adjustment procedure (see chapter 7)
160	CRC of stepmotor parameter wrong	- Change CPU board- Perform adjustment procedure (see chapter 7)
170	Timeout error when starting cross transport; no LS-signal	- Check cross bar mechanism- Perform adjustment procedure(see chapter 7)
171	See 170; cross transport is in front of light barrier	
172	See 170; cross transport is in front of reference LS	
173	See 170; cross transport is in front of excenter light barrier and reference LS	
174	Timeout error during detection half rotation of cross transport; no LS –signal	
175	See 174; cross transport is in front of excenter light barrier	
176	See 174; cross transport is in front of reference LS	
177	See 174; cross transport is in front of excenter light barrier and reference LS	

Table: tab-23e

13. Troubleshooting

LCD Error		
Error Code 200-299	Reason	What to do?
200	Busy signal error	- Check connections - Change display

Table: tab-24e

EEPROM Error		
Error Code 400-499	Reason	What to do?
400	CRC error during reading from EEPROM	- Change CPU board - Perform adjustment procedure (see chapter 7)
401	CRC error during writing to EEPROM	- Change CPU board - Perform adjustment procedure (see chapter 7)
402	CRC error of control codes external printer	

Table: tab-25e

RAM Error		
Error Code 500-599	Reason	What to do?
500 - 531	Error during writing resp. reading of byte information 0 x AA of 32k RAM	- Change CPU board - Perform adjustment procedure (see chapter 7)
550- 581	Error during writing resp. reading of byte information 0 x 55 of 32k RAM	- Change CPU board - Perform adjustment procedure (see chapter 7)

Table: tab-26e

RAM Error		
Error Code 600-699	Reason	What to do?
600	Checksum error of ROM	- Change Chip card

Table: tab-27e

RTC Error		
Error Code 700-799	Reason	What to do?
700	Accumulator condition not in order	- Change CPU board - Perform adjustment procedure (see chapter 7)
710	SWO-exit defective	- Change CPU board - Perform adjustment procedure (see chapter 7)

Table: tab-28e

13. Troubleshooting

Divide/Measuring-LED Error		
Error Code 800-899	Reason	What to do?
800	error during waiting of measuring LEDs	- Check/ change measuring head - Change CPU board - Perform adjustment procedure (see chapter 7)
820	PGA not adjustable	- Check/ change measuring head - Change CPU board - Perform adjustment procedure (see chapter 7)
821	These 3 error numbers are	- Check/ change measuring head - Change CPU board - Perform adjustment procedure (see chapter 7)
822	calculated by the software	- Check/ change measuring head - Change CPU board - Perform adjustment procedure (see chapter 7)
830	Green LED defective	- Check/ change measuring head - Change CPU board - Perform adjustment procedure (see chapter 7)
831	Orange LED defective	- Check/ change measuring head - Change CPU board - Perform adjustment procedure (see chapter 7)
832	Red LED defective	- Check/ change measuring head - Change CPU board - Perform adjustment procedure (see chapter 7)

Table: tab-29e

Programing Error		
Error Code 900-999	Reason	What to do?
900 - 999	Programing errors must not occur	- Check step-motor position - Perform adjustment procedure (see chapter 7)

Table: tab-30e

13. Troubleshooting

Error during software update: Display-hint "error no.xx"		
Error Code 01-12	Reason	What to do?
01	Error during programming Flash	
02	Error during deleting Flash	
03	Wrong ROM checksum	
04	Abort by user	
05	Error during serial transmission	
06	Timeout during transmission	
07	Buffer overflow during serial receipt	
08	Wrong record length of Hex-file	
09	Wrong checksum of Hex-file record	
10	No chipcard inserted	
11	Program identification wrong	
12	Illegal sign in Hex-file	

Table: tab-31e

14. Spare Parts

14.1 Complete spare part list

Partname	ID Number	Status	Remarks
Cable to PCB Main to PCB Interface	1997467	30	flexible cable only
Cable to PCB Measuring Head	1702793	30	flexible cable only
Carrier for tray	1702769	30	plastic part only
Clip set	1709631	30	5 pcs. meas.head, 10 pcs. cross bar, 10pcs. sole bar
Display	1221817	30	with cable
Keyboard	1997432	30	with cable
LED Lightbarrier	1702572	30	with cable
Lid for Printer	1702700	30	plastic part only
Motor Belt Drive Cross Transport	1997521	30	with holder, cable and light barrier
Motor Measuring Head Unit	1997530	30	with cable
PCB Interface Junior II	1997513	30	board with cable
PCB Main	1997424	30	bord compl. with guide for chip card
PCB Measuring Head	1702696	30	with light protection and clip
Printer Junior II	1997505	30	with cable
Reference Field Carrier	1702777	30	plastic part with reference field
Service Manual Junior II	1997491	30	English only
Status LED	1702661	30	with cable and holder
Suspension complete	1702688	30	upper and lower part with plastic guides
Tooth Bar Measuring Head Unit	1702785	30	upper and lower plastic part with spring
Top of housing	1997459	30	with cable clips
Transport arm	1702637	30	plastic part only
Tray	1702629	30	plastic part only
User Program I Chip Card	1997548	30	
User Program II Chip Card	1997556	30	

Table: tab-8e

14. Spare Parts

14.2 Part identification



Fig. 53 Cable to PCB Main to PCB Interface (1997467)

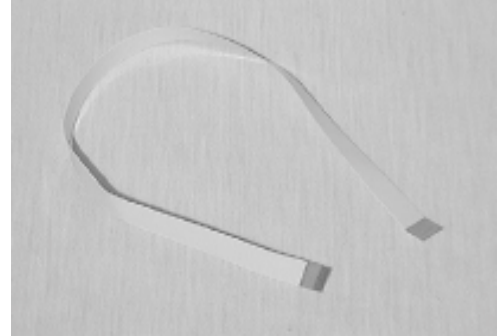

Fig. 43 Cable to PCB Measuring Head (1702793)

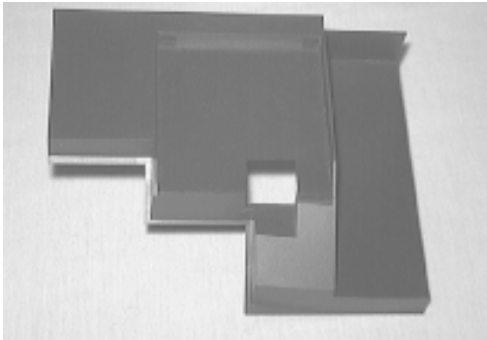

Fig. 41 Carrier for Tray (1702769)

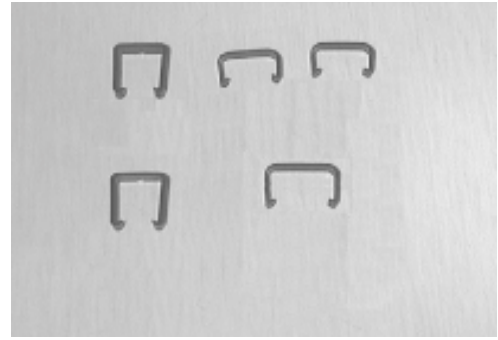

Fig. 48 Clip set (1709631)

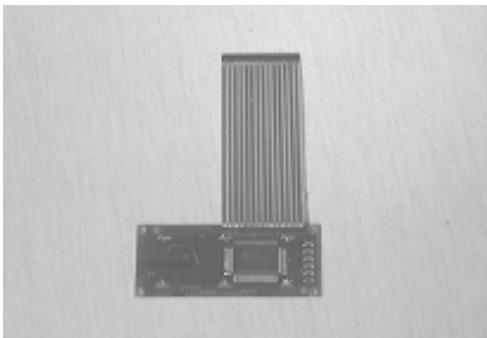

Fig. 51 Display (1221817)



Fig. 28 Keyboard (1997432)

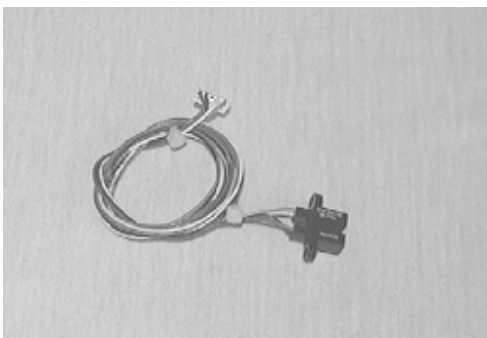

Fig. 46 Lightbarrier (1702572)

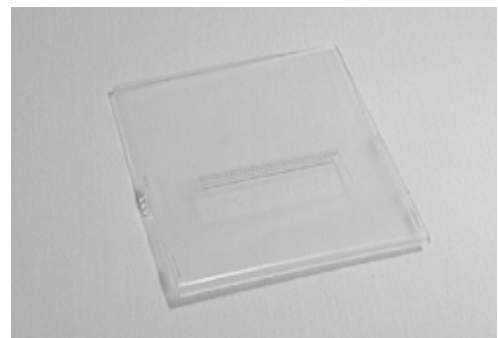

Fig. 57 Lid for printer (1997564)

14. Spare Parts

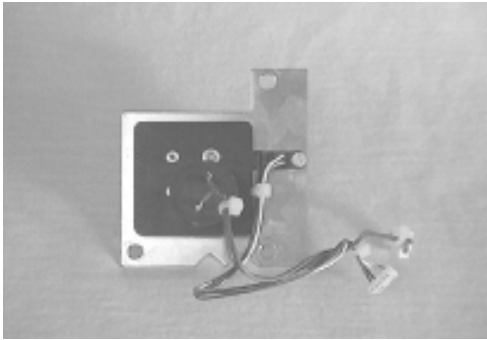

Fig. 56 Motor Belt Drive Cross Transport (1997521)



Fig. 45 Motor Measuring Head Unit (1997530)



Fig. 52 PCB Interface (1997513)

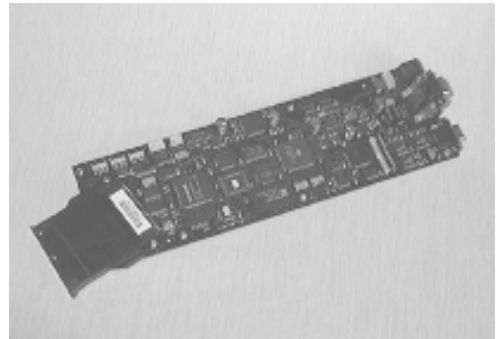

Fig. 47 PCB Main (1997424)

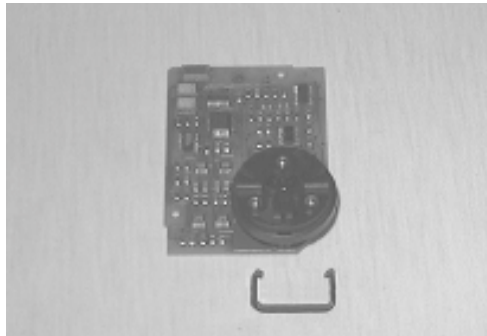

Fig. 42 PCB Measuring Head (1702696)

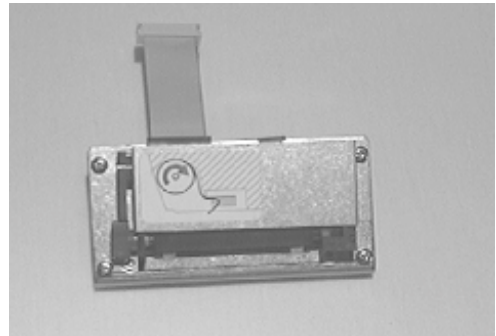

Fig. 49 Printer Junior II (1997505)



Fig. 40 Reference Field Carrier (1702777)

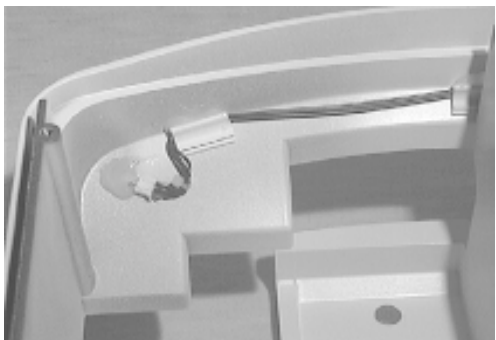

Fig. 27 Status LED (1702661)

14. Spare Parts

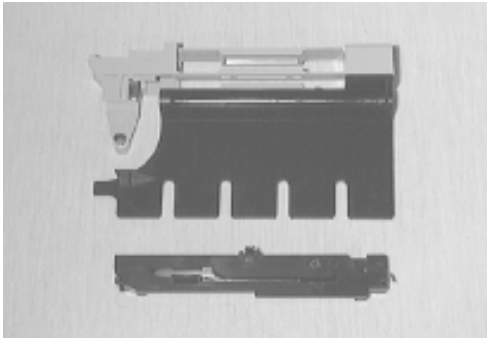

Fig. 55 Suspension compl. (1702688)

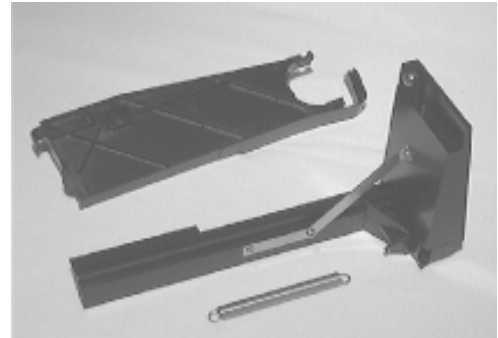

Fig. 44 Tooth Bar Measuring Head Unit (1702785)



Fig. 58 Top of housing (1997459)

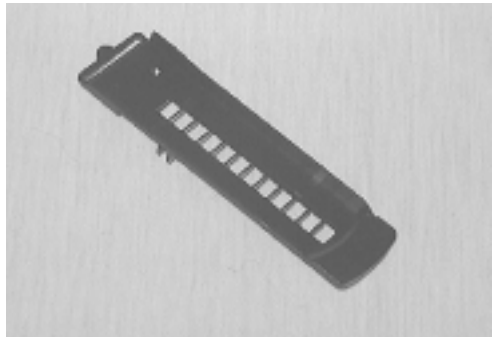

Fig. 38 Transport arm (1702637)



Fig. 39 Tray (1702629)



Fig. 62 User Program Chip Card I + II

14. Spare Parts

14.3 Exploded view Miditron® Junior II

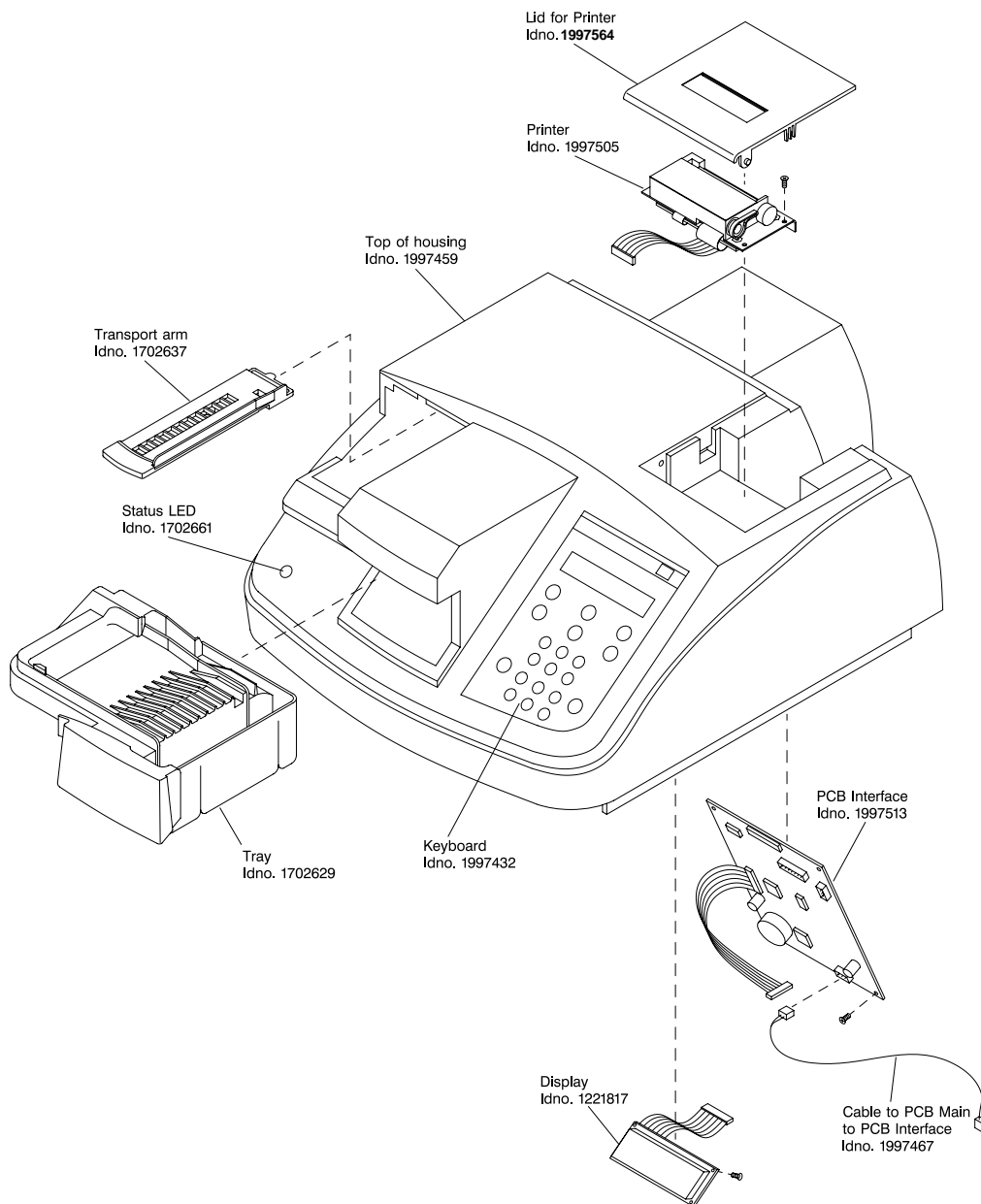

14. Spare Parts

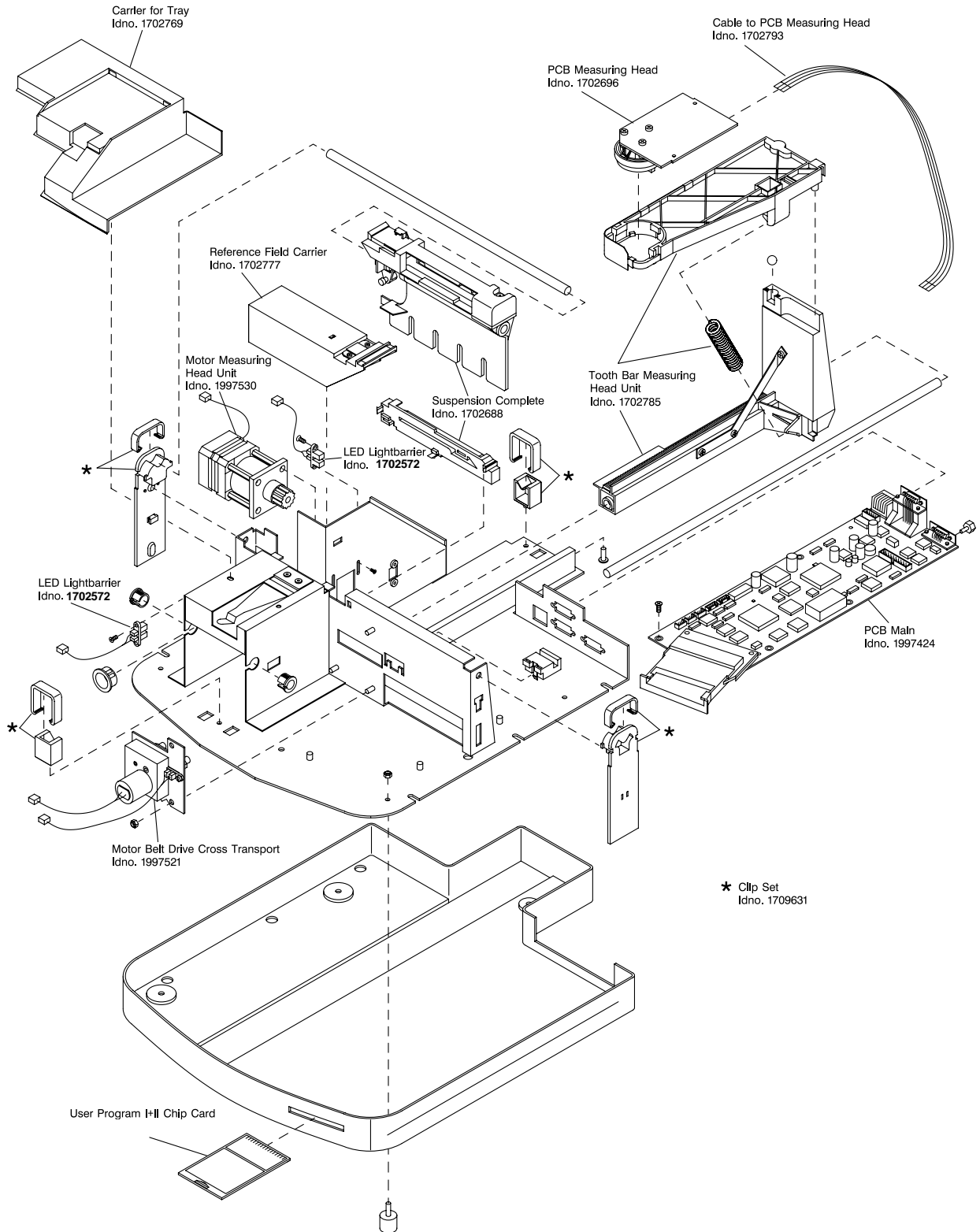

15. Instrument, Strips, Accessories

15.1 Complete list

Partname Instruments, Strips, Accessories	ID- Number	St.	Remarks
Miditron® Junior II	1937596		
Combur10Test® M (100 strips)	1379208		
Combur9Test® M (100 strips)	1447637		
Control-Test M (50 strips)	1379194		
Adjustment strips (10 strips)	1704656		used for adjustment procedure (service only)
Printer Paper for Miditron® Junior II (5 rolls)	1906020		
Test Strip Tray for Fast Mode	1703170		
Operator's Manual (in 5 languages)	1953869		
Transport Arm	1702637		
Strip Receiving Tray (incl. Waste Tray)	1702629		
Power Supply	1882619		
Power Cable, EURO Version	1800515		
Power Cable, US Version	1800523		
Barcode Reader			Information see Operator's Manual
External Printer			Information see Operator's Manual

Table: tab-8-1e

16. Interface Assignment

Miditron® Junior II has three RS 232 C serial ports for connecting the following devices:

- host/PC
- barcode reader
- external printer

These ports can be enabled and disabled in the interface setup menus.

If "Host/PC Yes" is selected in the Setup menu, data will be sent to the host/PC port as an ASCII dataset.

Please contact RD to receive a detailed description of the ports and data protocols.

The results obtained with **Miditron® Junior II** may be sent to a host/PC using an industry-standard interface cable. If "Host/PC Yes" is selected in the Setup menu, **Miditron® Junior II** will upload the report along with a checksum to the host/PC. To ensure that any transmission errors are detected, the communication software of the host/PC should verify the checksum.

To upload reports to a host/PC, use only cables conforming to the following specification.

16.1 Host/PC interface

Connector: D-Sub, 9 pins, male

Cable configuration:

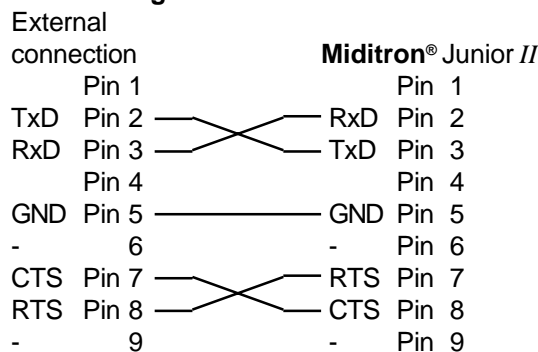

Length 2 metres maximum, shielded, shield is connected to both connector housings.



Data cables not conforming to this specification may cause Miditron® Junior II to malfunction!

16. Interface Assignment

16.2 External Printer interface

Connector: D-Sub, 9 pins, male

Cable configuration:

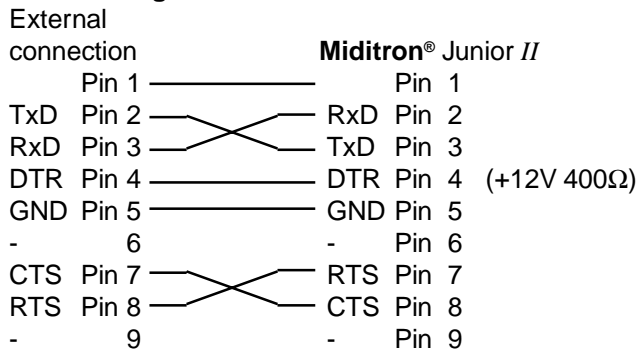

Length 2 metres maximum, shielded, shield is connected to both connector housings.



Data cables not conforming to this specification may cause Miditron® Junior II to malfunction!

16.3 Barcode reader interface

Connector: D-Sub, 9 pins, female

Cable configuration:

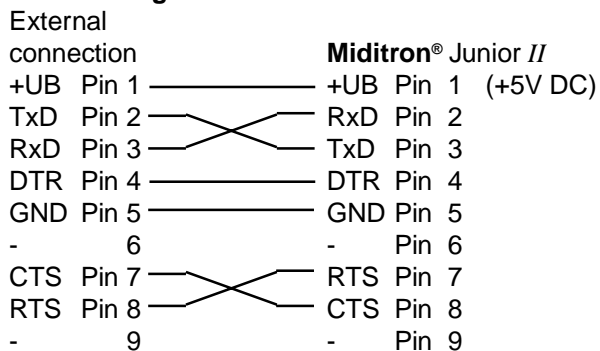

Length 2 metres maximum, shielded, shield is connected to both connector housings.



Data cables not conforming to this specification may cause Miditron® Junior II to malfunction!

17. Routine Care and Cleaning

17.1 General

Miditron® Junior II is a maintenance-free instrument. For reasons of hygiene, keep the exterior of the analyzer clean. Where necessary, the exterior surfaces may be cleaned with commercial cleaning and disinfecting agents, preferably 70 % isopropanol.

The transport arm, waste tray and strip receiving tray may be cleaned in the laboratory washer (at +55°).

17.2 Cleaning

All parts that come into contact with urine should be cleaned daily. These are:

- the transport arm
- the strip receiving tray / waste tray
- the Test Strip Tray for Fast Mode.



We recommend the wearing of gloves for cleaning the analyzer, as indeed for carrying out the tests.



Fig. 1

To clean the analyzer, proceed as follows:

1. Carefully lift and remove the transport arm (Fig. 1)
2. Thoroughly rinse the transport arm under running water and disinfect with a solution such as 0.5 % sodium hypochlorite or 70 % isopropanol. Again rinse thoroughly with water and dry well. Use a cotton gauze or swab for thorough cleaning around awkward edges.



Fig. 12

3. After detaching the transport arm, remove the strip receiving tray / waste tray by grasping its outer edges and gently pulling it out of the analyzer. (Fig. 12). Dispose of used test strips in a proper receptacle. Clean and disinfect the strip receiving tray / waste tray as described above. Rinse thoroughly with water and dry well.

Take care that the rear inside edge of the strip receiving tray / waste tray is properly cleaned. The presence of urine sediments may stop test strips from transporting properly.

Note: The simplest and most convenient practice is to allow the transport arm and strip receiving tray to dry overnight. When drying by hand for immediate re-use, be sure to use a lint-free cloth.

4. Clean the Test Strip Tray for Fast Mode in the same way.

17. Routine Care and Cleaning



Fig. 12

To re-insert the cleaned parts, proceed as follows:

1. Grasp the strip receiving tray by its outer edges and insert it into the analyzer along the guide bar until it eases into position (Fig. 12).
2. Then grasp the transport arm by its handle end and, while holding it at an angle of 45° from the vertical, insert it as far as it will go along the visible guide, then push down so it snaps into position (Fig. 1).



Fig. 1