

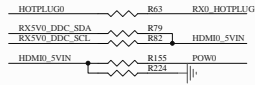

CN12	23	GND
GND	22	GND
GND	21	GND
GND	20	GND
19	HOTPLUG0	
18	HDMI_SVIN	
17	GND	
16	RXSVD_DDC_SDA	
15	RXSVD_DDC_SCL	
14	CECT1	
12	HDMI_RXC-	
11	HDMI_RXC+	
10	HDMI_RXD+	
9	HDMI_RXD-	
8	GND	
7	HDMI_RX0+	
6	HDMI_RX1+	
5	GND	
4	HDMI_RX1-	
3	HDMI_RX2+	
2	GND	
1	HDMI_RX2-	

471511051

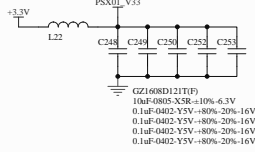

- 0ohm 0402 ±5% 1/16W
- 10Kohm 0402 ±5% 1/16W
- 10Kohm 0402 ±5% 1/16W
- 36Kohm 0402 ±5% 1/16W
- 10Kohm 0402 ±5% 1/16W

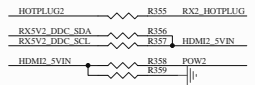

- 0ohm 0402 ±5% 1/16W
- 10Kohm 0402 ±5% 1/16W
- 10Kohm 0402 ±5% 1/16W
- 36Kohm 0402 ±5% 1/16W
- 10Kohm 0402 ±5% 1/16W

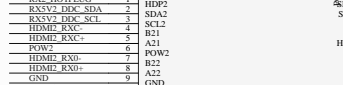
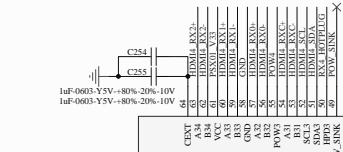

- 0ohm 0402 ±5% 1/16W
- 10Kohm 0402 ±5% 1/16W
- 10Kohm 0402 ±5% 1/16W
- 36Kohm 0402 ±5% 1/16W
- 10Kohm 0402 ±5% 1/16W



- 0ohm 0402 ±5% 1/16W
- 10Kohm 0402 ±5% 1/16W
- 10Kohm 0402 ±5% 1/16W
- 36Kohm 0402 ±5% 1/16W
- 10Kohm 0402 ±5% 1/16W

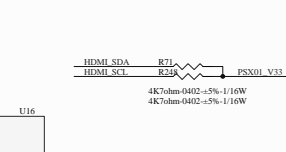

- 0ohm 0402 ±5% 1/16W
- 10Kohm 0402 ±5% 1/16W
- 10Kohm 0402 ±5% 1/16W
- 36Kohm 0402 ±5% 1/16W
- 10Kohm 0402 ±5% 1/16W

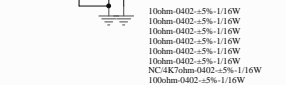

- 0ohm 0402 ±5% 1/16W
- 10Kohm 0402 ±5% 1/16W
- 10Kohm 0402 ±5% 1/16W
- 36Kohm 0402 ±5% 1/16W
- 10Kohm 0402 ±5% 1/16W

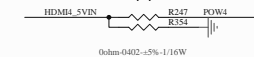
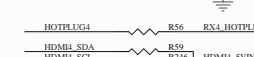
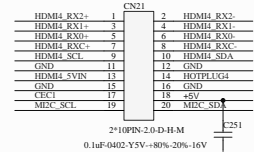

- 0ohm 0402 ±5% 1/16W
- 10Kohm 0402 ±5% 1/16W
- 10Kohm 0402 ±5% 1/16W
- 36Kohm 0402 ±5% 1/16W
- 10Kohm 0402 ±5% 1/16W

CN13	23	GND
GND	22	GND
GND	21	GND
GND	20	GND
19	HOTPLUG4	
18	HDMI_SVIN	
17	GND	
16	RXSVD_DDC_SDA	
15	RXSVD_DDC_SCL	
14	CECT1	
12	HDMI_RXC-	
11	HDMI_RXC+	
10	HDMI_RXD+	
9	HDMI_RXD-	
8	GND	
7	HDMI_RX0+	
6	HDMI_RX1+	
5	GND	
4	HDMI_RX1-	
3	HDMI_RX2+	
2	GND	
1	HDMI_RX2-	

471511051



- NC/10Kohm 0402 ±5% 1/16W
- NC/10Kohm 0402 ±5% 1/16W
- NC/22pF 0402-NPO ±5% 50V
- NC/22pF 0402-NPO ±5% 50V



- NC/10Kohm 0402 ±5% 1/16W
- NC/10Kohm 0402 ±5% 1/16W
- NC/22pF 0402-NPO ±5% 50V
- NC/22pF 0402-NPO ±5% 50V



- NC/10Kohm 0402 ±5% 1/16W
- NC/10Kohm 0402 ±5% 1/16W
- NC/22pF 0402-NPO ±5% 50V
- NC/22pF 0402-NPO ±5% 50V



- NC/10Kohm 0402 ±5% 1/16W
- NC/10Kohm 0402 ±5% 1/16W
- NC/22pF 0402-NPO ±5% 50V
- NC/22pF 0402-NPO ±5% 50V



- NC/10Kohm 0402 ±5% 1/16W
- NC/10Kohm 0402 ±5% 1/16W
- NC/22pF 0402-NPO ±5% 50V
- NC/22pF 0402-NPO ±5% 50V



- NC/10Kohm 0402 ±5% 1/16W
- NC/10Kohm 0402 ±5% 1/16W
- NC/22pF 0402-NPO ±5% 50V
- NC/22pF 0402-NPO ±5% 50V

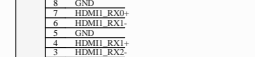
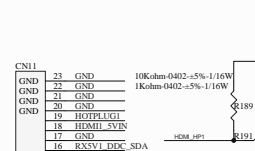

- NC/10Kohm 0402 ±5% 1/16W
- NC/10Kohm 0402 ±5% 1/16W
- NC/22pF 0402-NPO ±5% 50V
- NC/22pF 0402-NPO ±5% 50V

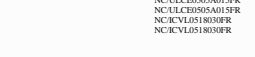
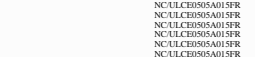

- NC/10Kohm 0402 ±5% 1/16W
- NC/10Kohm 0402 ±5% 1/16W
- NC/22pF 0402-NPO ±5% 50V
- NC/22pF 0402-NPO ±5% 50V

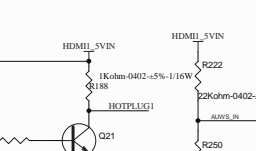

- NC/10Kohm 0402 ±5% 1/16W
- NC/10Kohm 0402 ±5% 1/16W
- NC/22pF 0402-NPO ±5% 50V
- NC/22pF 0402-NPO ±5% 50V



- NC/10Kohm 0402 ±5% 1/16W
- NC/10Kohm 0402 ±5% 1/16W
- NC/22pF 0402-NPO ±5% 50V
- NC/22pF 0402-NPO ±5% 50V

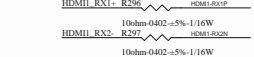
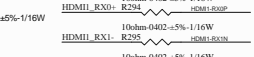
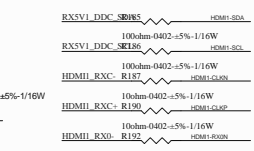

- NC/10Kohm 0402 ±5% 1/16W
- NC/10Kohm 0402 ±5% 1/16W
- NC/22pF 0402-NPO ±5% 50V
- NC/22pF 0402-NPO ±5% 50V



- NC/10Kohm 0402 ±5% 1/16W
- NC/10Kohm 0402 ±5% 1/16W
- NC/22pF 0402-NPO ±5% 50V
- NC/22pF 0402-NPO ±5% 50V



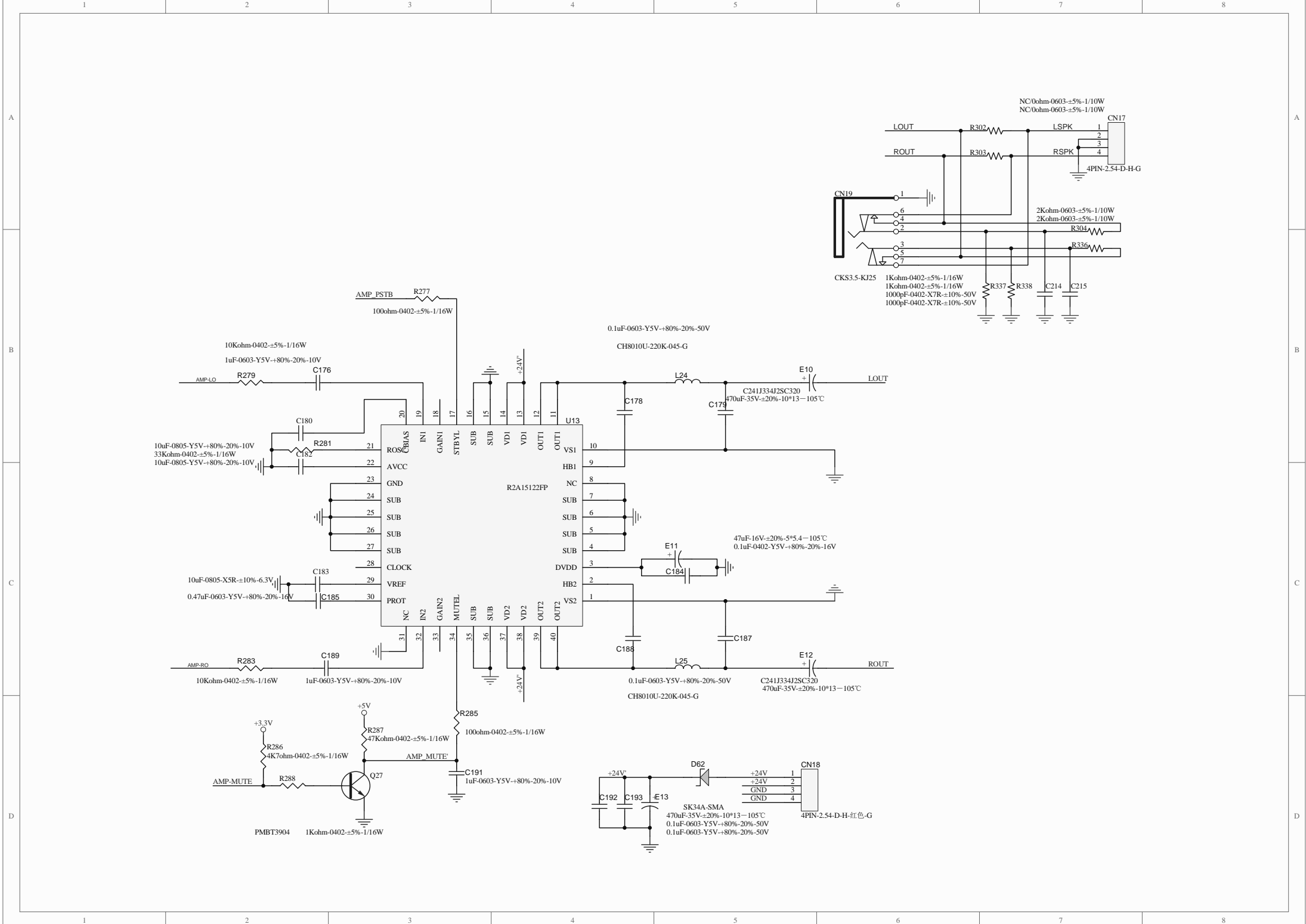

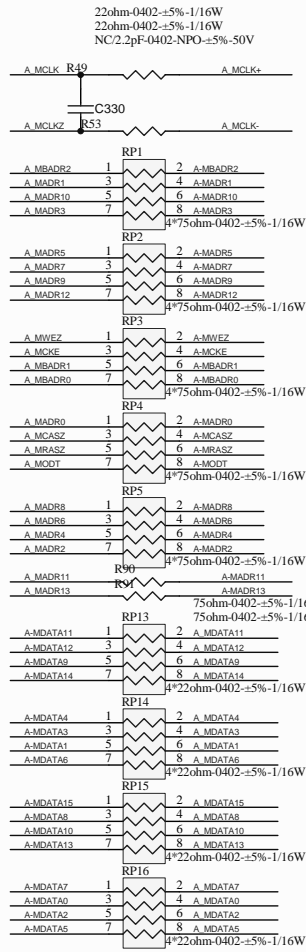

220hm-0402-±5%-1/16W  
220hm-0402-±5%-1/16W  
220hm-0402-±5%-1/16W  
220hm-0402-±5%-1/16W  
220hm-0402-±5%-1/16W

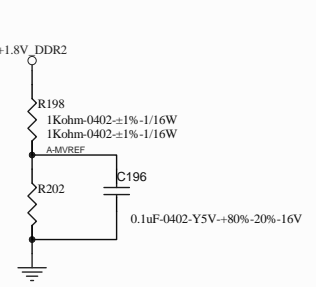
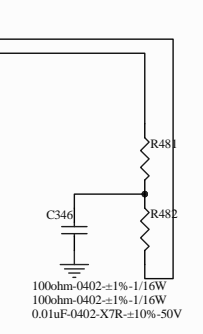
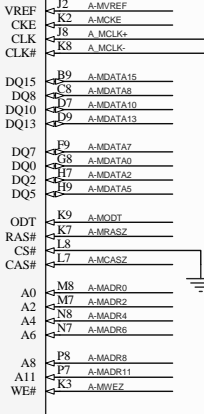
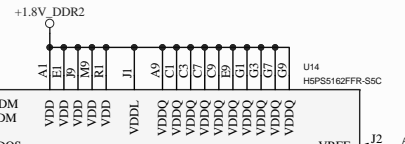
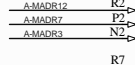
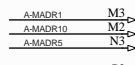
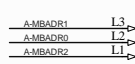
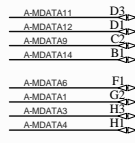
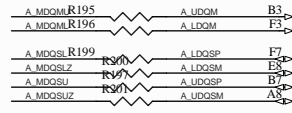

0.1uF-0402-Y5V-±80%-20%-16V  
0.1uF-0402-Y5V-±80%-20%-16V  
0.47uF-0402-Y5V-±80%-20%-10V  
0.47uF-0402-Y5V-±80%-20%-10V  
0.1uF-0402-Y5V-±80%-20%-16V  
0.1uF-0402-Y5V-±80%-20%-16V

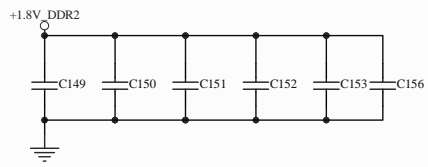

10uF-0805-X5R-±10%-6.3V  
0.1uF-0402-Y5V-±80%-20%-16V  
0.47uF-0402-Y5V-±80%-20%-10V  
1uF-0603-Y5V-±80%-20%-10V  
0.1uF-0402-Y5V-±80%-20%-16V  
0.1uF-0402-Y5V-±80%-20%-16V  
0.1uF-0402-Y5V-±80%-20%-16V

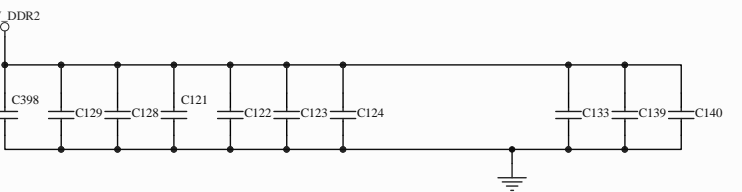

0.1uF-0402-Y5V-±80%-20%-16V  
0.1uF-0402-Y5V-±80%-20%-16V  
0.47uF-0402-Y5V-±80%-20%-10V

