

Service Manual

Cassette Deck
RS-631

Front-Loading Vertical Hold High Fidelity Stereo
Cassette Deck with Memory Auto Play and Separate
3-Position Bias/Equalization Selectors



RS-631 MECHANISM SERIES

Specifications (Catalog specifications for sales)

Power requirement:	AC; 110/125/220/240V, 50/60Hz	Input:	MIC; sensitivity 0.25 mV, applicable microphone impedance 400Ω~20KΩ
	Power consumption; 13 W		LINE; sensitivity 60 mV, input impedance 33 KΩ
Motor:	FG servo DC motor		DIN; sensitivity 0.26 mV, input impedance 1.5 KΩ
Track system:	4-track 2-channel stereo recording and playback	Output:	LINE; output level 420 mV, load impedance 47 KΩ over
Tape speed:	4.8 cm/s		DIN; output level 420 mV, output impedance 10 KΩ over
Wow and flutter:	0.06% (WRMS), ±0.15% (DIN)		HEADPHONE; output level 60 mV, load impedance 8Ω
Frequency response:	CrO ₂ /FeCr tape; 25~16,000 Hz	Rec/pb connection:	5 P DIN type
	30~15,000 Hz (DIN)	Head:	2-head system
	40~14,000 Hz ±3 dB		1-HPF head for record/playback
	Normal tape; 25~14,000 Hz		1-double-gap ferrite head for erasure
	30~13,000 Hz (DIN)	Dimensions:	43.0 cm(W) × 14.9 cm(H) × 26.7 cm(D)
	40~12,000 Hz ±3 dB	Weight:	7.6 kg
Signal-to-nois ratio:	Dolby NR in; 67 dB (above 5 kHz)		
	Dolby NR out; 57 dB (signal level = max. recording level, CrO ₂ /FeCr tape)		
Fast forward and rewind time:	Approx. 90 seconds with C-60 cassette tape		

Specifications are subject to change without notice.

 **Technics**

Matsushita Electric Trading Co., Ltd.
P.O. Box 288, Central Osaka Japan

LOCATION OF CONTROLS AND COMPONENTS

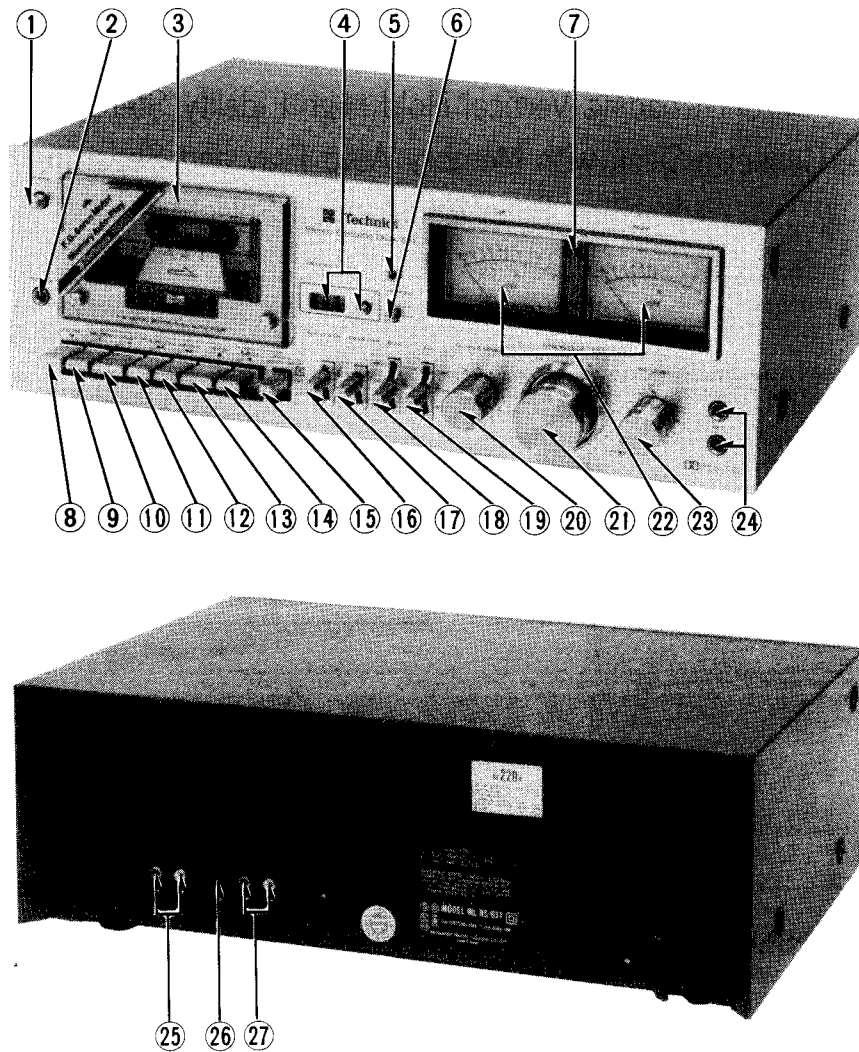
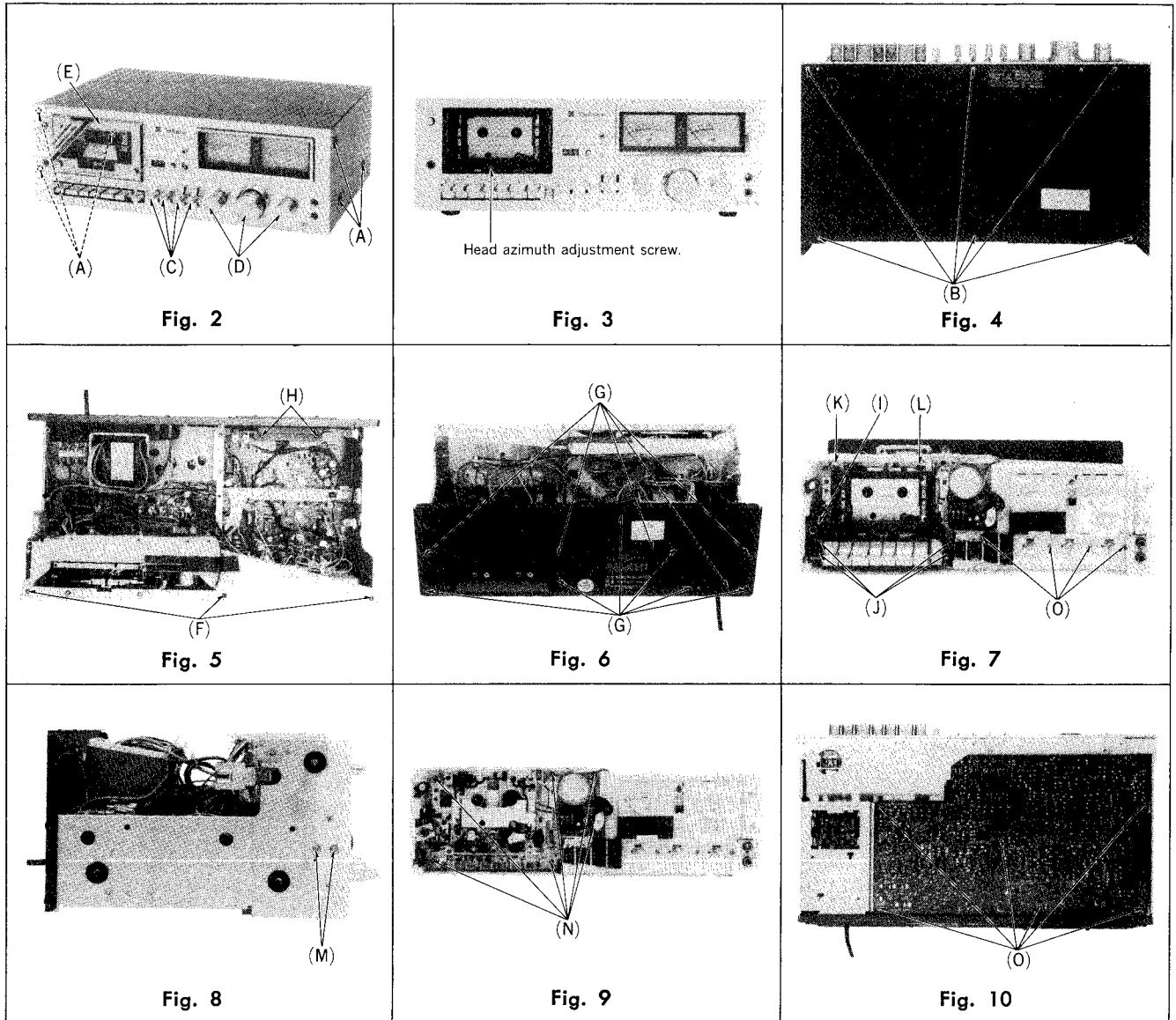

Fig. 1

- | | |
|---------------------------------|-------------------------------------|
| ① Power switch | ⑮ Timer stand-by button |
| ② Headphones jack | ⑯ Peak-signal-check switch |
| ③ Cassette compartment door | ⑰ Dolby noise-reduction switch |
| ④ Tape counter and reset button | ⑱ Bias selector |
| ⑤ Memory indication lamp | ⑲ Equalization selector |
| ⑥ Memory switch | ⑳ Output level control |
| ⑦ Recording indication lamp | ㉑ Line input level controls |
| ⑧ Pause button | ㉒ Peak level/VU meters |
| ⑨ Record button | ㉓ Microphone level controls |
| ⑩ Playback button | ㉔ Microphone jacks |
| ⑪ Rewind/review button | ㉕ Line output jacks |
| ⑫ Fast forward/cue button | ㉖ Record/playback connection socket |
| ⑬ Stop button | ㉗ Line input jacks |
| ⑭ Eject button | |

DISASSEMBLY INSTRUCTIONS



Procedure	To remove ——— .	Remove ——— .	Shown in fig. ——— .
1	Case cover	• 6 black screws (A)	2
2	Bottom cover	• 6 screws (B)	4
3	Front panel	• 4 lever knobs (C) • 3 control knobs (D) • Cassette lid (E) ※ • 3 red screws (F)	2 2 2, 3 5
3	Rear board	• 11 black screws (G) • 2 red screws (H)	6 5
5	Control button assembly and cassette holder	• Headphones jack cover (I) • 4 red screws (J) • Stop ring (K) • Cassette holder spring (L)	7 7 7 7
6	Mechanism	• 2 headphones jack holding screw ... (M) • 6 red screws (N)	8 9
6	Main amplifier	• 10 red screws (O)	7, 10

※ The head azimuth can be adjusted by removing the cassette lid (E) as shown in fig. 3.

MEASUREMENT AND ADJUSTMENT METHOD

NOTE:

- | | |
|---|---|
| <ol style="list-style-type: none"> 1. Make sure heads are clean. 2. Make sure capstan and pressure roller are clean. 3. Judgeable room temperature: $20 \pm 5^{\circ}\text{C}$ ($68 \pm 9^{\circ}\text{F}$). | <ol style="list-style-type: none"> 4. Dolby NR switch: OUT. 5. Bias selector: LOW. 6. Equalizer selector: $120\mu\text{S}$. |
|---|---|

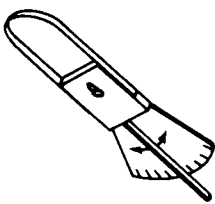
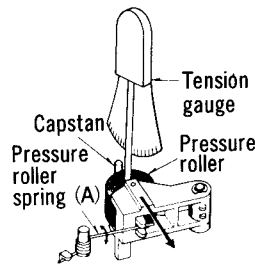
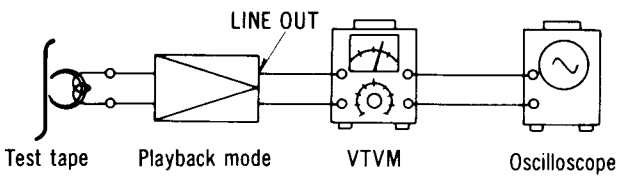
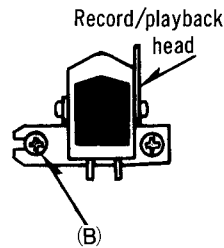
ITEM	MEASUREMENT & ADJUSTMENT	REMARKS
<p>Pressure of pressure roller Equipment: * Tension gauge (max. 500 gr)</p>  <p style="text-align: center;">Fig. 11</p>	<ol style="list-style-type: none"> 1. Place UNIT into playback mode. 2. Hook the tension gauge to pressure roller lever and pull it in the direction of the arrow as shown in fig. 12. 3. Measure the tension at the moment when the pressure roller moves away from the capstan. <div style="border: 1px solid black; padding: 5px; width: fit-content; margin: 10px auto;"> <p style="text-align: center;">Standard value: 400 ± 50 gr</p> </div> <p>Adjustment method Bend the part (A) of the pressure roller spring in either direction shown by the arrow until the correct pressure is attained.</p>	<p>* Playback mode</p>  <p style="text-align: center;">Fig. 12</p>
<p>Takeup tension Equipment: * Cassette torque meter ... QZZSRKCT</p>	<ol style="list-style-type: none"> 1. Mount cassette torque meter on UNIT. 2. Place UNIT into playback mode and read takeup torque. 3. Measure several times and determine the mean value. <div style="border: 1px solid black; padding: 5px; width: fit-content; margin: 10px auto;"> <p style="text-align: center;">Standard value: 55 ± 15 gr-cm</p> </div>	<p>* Playback mode</p>
<p>Head azimuth adjustment Equipment: * VTVM * Oscilloscope * Test tape (azimuth) ... QZZCFM</p>	<p>Record/playback head adjustment</p> <ol style="list-style-type: none"> 1. Test equipment connection is shown below. <div style="text-align: center;">  </div> <p style="text-align: center;">Fig. 13</p> <ol style="list-style-type: none"> 2. Play azimuth tape (QZZCFM 8 kHz). 3. Adjust record/playback head angle adjustment-screw (B) in fig. 14 so that output level at LINE OUT becomes maximum. 4. Measure both channels, and adjust levels for equal output. 5. After adjustment lock head adjustment screw with lacquer. 	<p>* Playback mode</p>  <p style="text-align: center;">Fig. 14</p>

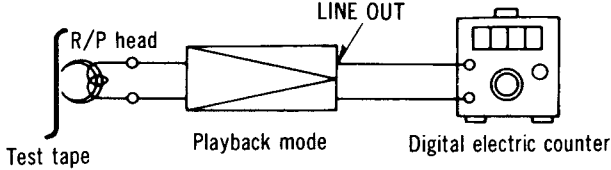
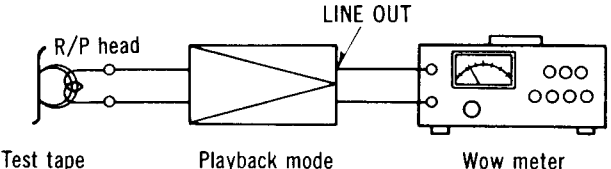
ITEM	MEASUREMENT & ADJUSTMENT	REMARKS
<p>Tape speed</p> <p>Equipment:</p> <ul style="list-style-type: none"> * Digital electronic counter or frequency counter (RP8067) * Test tape...QZZCWAT 	<p>Tape speed accuracy</p> <p>1. Test equipment connection is shown below.</p>  <p style="text-align: center;">Fig. 15</p> <p>2. Play test tape (QZZCWAT 3,000Hz), and supply playback signal to frequency counter.</p> <p>3. Measure this frequency.</p> <p>4. On the basis of 3,000Hz, determine value by following formula:</p> $\text{Tape speed accuracy} = \frac{f - 3,000}{3,000} \times 100 (\%)$ <p style="text-align: center;">where, f = measured value</p> <p>5. Take measurement at middle section of tape.</p> <div style="border: 1px solid black; padding: 5px; width: fit-content; margin: 10px auto;"> <p style="text-align: center;">Standard value: ±1.5%</p> </div> <p>Adjustment method</p> <ol style="list-style-type: none"> 1. Play the test tape (middle). 2. Adjust VR201 so that frequency becomes 3,000 Hz. <p>Tape speed fluctuation</p> <p>Make measurements in same manner as above (beginning, middle and end of tape), and determine difference between maximum and minimum values and calculate as follows:</p> $\text{Tape speed fluctuation} = \frac{f_1 - f_2}{3,000} \times 100 (\%)$ <p style="text-align: center;">f₁ = maximum value f₂ = minimum value</p> <div style="border: 1px solid black; padding: 5px; width: fit-content; margin: 10px auto;"> <p style="text-align: center;">Standard value: 1%</p> </div>	<p>* Playback mode</p>
<p>Wow and flutter</p> <p>Equipment:</p> <ul style="list-style-type: none"> * Wow meter * Test tape...QZZCWAT 	<p>1. Test equipment connection is shown below.</p>  <p style="text-align: center;">Fig. 16</p> <p>2. Use wow test tape (3,000Hz) and measure its playback signal on wow meter.</p> <p>3. Wow and flutter is expressed in percentage and that measurement can be weighted by JIS network (WRMS).</p> <p>4. Measure at middle section of test tape.</p> <div style="border: 1px solid black; padding: 5px; width: fit-content; margin: 10px auto;"> <p style="text-align: center;">Standard value: 0.1% (WRMS)</p> </div>	<p>* Playback mode</p>

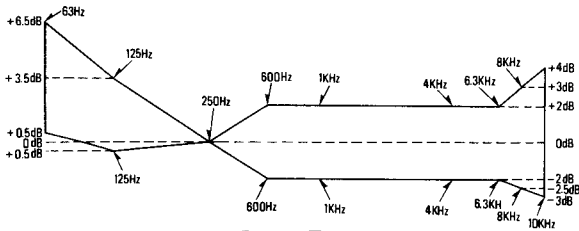
ITEM	MEASUREMENT & ADJUSTMENT	REMARKS
<p>Playback frequency response</p> <p>Equipment:</p> <ul style="list-style-type: none"> * VTVM * Oscilloscope * Test tape... QZZCFM 	<ol style="list-style-type: none"> 1. Test equipment connection is as same as "Head azimuth adjustment" but use the test tape instead of head azimuth tape (See fig. 17). 2. Place UNIT into playback mode. 3. Playback frequency response test tape. 4. Measure output level at 8kHz, 4kHz, 1kHz, 315Hz, 250Hz, 120Hz and 63Hz, and compare each output level with standard frequency 315Hz, at LINE OUT. 5. Make measurement for both channels. 6. Make sure that the measured value is within the range specified in the frequency response chart. <p style="text-align: center;">Playback frequency response chart</p>  <p style="text-align: center;">Fig. 17</p> <p>Adjustment method If the measured value is not standard, adjust VR1 (L-CH), VR2 (R-CH).</p>	<ul style="list-style-type: none"> * Playback mode * Output level control ... MAX
<p>Playback gain</p> <p>Equipment:</p> <ul style="list-style-type: none"> * VTVM * Oscilloscope * Test tape... QZZCFM 	<ol style="list-style-type: none"> 1. Test equipment connection is shown in fig. 13. 2. Play standard recording level portion on test tape (QZZCFM 315Hz), and using VTVM measure the output level at LINE OUT jack. 3. Make measurement for both channels. <div style="border: 1px solid black; padding: 5px; text-align: center; margin: 10px auto; width: fit-content;"> Standard value: 0.42V (-7dB) </div> <p>Adjustment method</p> <ol style="list-style-type: none"> 1. If measured value is not standard, adjust VR3 (L-CH), VR4 (R-CH) (See fig. 28 on page 10). 2. After adjustment, check "Playback frequency response" again. 	<ul style="list-style-type: none"> * Playback mode * Output level control ... MAX
<p>Playback S/N ratio</p> <p>Equipment:</p> <ul style="list-style-type: none"> * VTVM * Oscilloscope * Test tape... QZZCFM * Empty cassette 	<ol style="list-style-type: none"> 1. Test equipment connection is shown in fig. 13. 2. Play standard recording level test tape (QZZCFM 315Hz) and read output level on VTVM. Refer to "Playback gain adjustment". 3. Place empty cassette (which has been cut) and playback again. 4. Measure noise level at this time using VTVM, and determine ratio of this level to test tape output signal voltage (315Hz). <div style="border: 1px solid black; padding: 5px; text-align: center; margin: 10px auto; width: fit-content;"> Standard value: Greater than 43dB </div>	<ul style="list-style-type: none"> * Playback mode * Output level control ... MAX

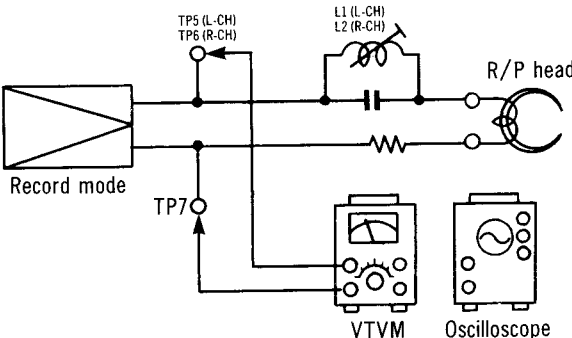
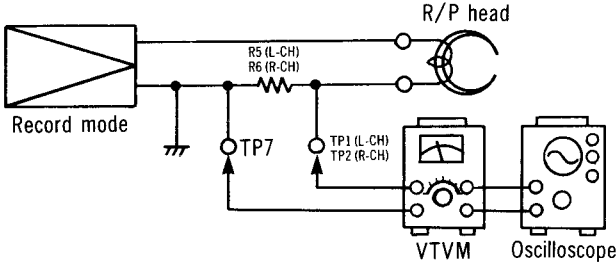
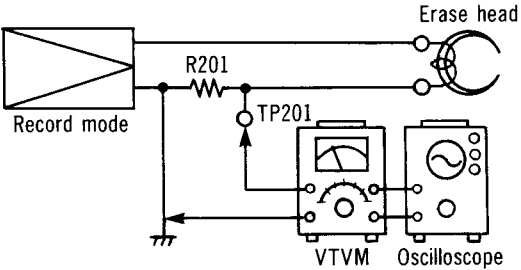
ITEM	MEASUREMENT & ADJUSTMENT	REMARKS
<p>Bias leak</p> <p>Equipment:</p> <ul style="list-style-type: none"> * VTVM * Oscilloscope 	<p>1. Test equipment connection is shown below.</p>  <p style="text-align: center;">Fig. 18</p> <p>2. Place UNIT into record mode.</p> <p>3. Adjust trap coil L1 (L-CH), L2 (R-CH), so that measured value on VTVM becomes minimum.</p> <p>4. Take adjustment for both channels.</p>	<ul style="list-style-type: none"> * Record mode
<p>Bias current</p> <p>Equipment:</p> <ul style="list-style-type: none"> * VTVM * Oscilloscope 	<p>1. Test equipment connection is shown below.</p>  <p style="text-align: center;">Fig. 19</p> <p>2. Place UNIT into record mode, and bias selector to "LOW".</p> <p>3. Read voltage on VTVM and calculate bias current by following formula:</p> $\text{Bias current (A)} = \frac{\text{Value read on VTVM (V)}}{10 (\Omega)}$ <div style="border: 1px solid black; padding: 5px; margin: 10px 0;"> <p>Standard value:</p> <p>80 ± 20 (LOW position)</p> <p>84 ± 20 (MED position)</p> <p>100 ± 20 (HIGH position)</p> </div> <p>4. Adjust VR15 (L-CH) and VR16 (R-CH) (See adjustment part location on page 10).</p>	<ul style="list-style-type: none"> * Record mode * When bias current is adjusted on one channel only, note that bias current on the other channel may vary.
<p>Erase current</p> <p>Equipment:</p> <ul style="list-style-type: none"> * VTVM * Oscilloscope 	<p>1. Test equipment connection is shown below.</p>  <p style="text-align: center;">Fig. 20</p>	<ul style="list-style-type: none"> * Record mode * Bias selector ... LOW

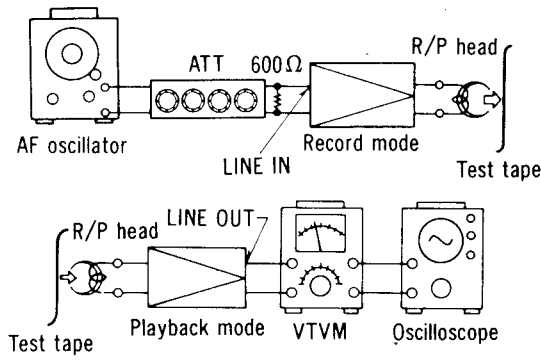
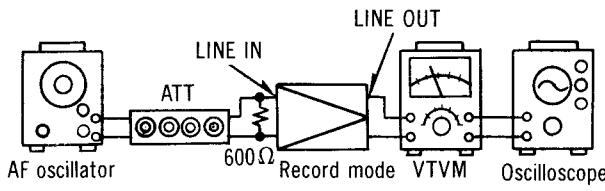
ITEM	MEASUREMENT & ADJUSTMENT	REMARKS
	<p>2. Place UNIT into record mode and set the bias selector to LOW position.</p> <p>3. Read voltage on VTVM and calculate erase current by following formula:</p> $\text{Erase current (A)} = \frac{\text{Value read on VTVM (V)}}{1 (\Omega)}$ <div style="border: 1px solid black; padding: 5px; width: fit-content; margin: 10px auto;"> <p>Standard value: More than 40 mA</p> </div>	
<p>Overall gain</p> <p>Equipment:</p> <ul style="list-style-type: none"> * AF oscillator * VTVM * ATT * Oscilloscope * Test tape (reference blank tape) ...QZZCRA for Normal 	<p>1. Test equipment connection is shown in fig. 21.</p>  <p style="text-align: center;">Fig. 21</p> <p>2. Place UNIT into record mode, and equalizer selector to 120μS, bias selector to LOW (for normal tape).</p> <p>3. Supply 1 kHz signal (-24 dB) from AF oscillator, through ATT, to LINE IN.</p> <p>4. Adjust ATT until monitor level at LINE OUT becomes 0.42 V (-7 dB).</p> <p>5. Using test tape, make recording.</p> <p>6. Playback recorded tape, and make sure the value at LINE OUT on VTVM becomes 0.42 V.</p> <p>7. If measured value is not 0.42 V, adjust VR9 (L-CH), VR10 (R-CH) (See fig. 28 on page 10).</p> <p>8. Repeat from step (2).</p>	<ul style="list-style-type: none"> * Record/playback mode * LINE IN level control ... MAX * Output level control ... MAX * Standard input level: MIC -72 \pm 3 dB LINE IN ... -24 \pm 3 dB
<p>Level meter</p> <p>Equipment:</p> <ul style="list-style-type: none"> * VTVM * Oscilloscope * AF oscillator * ATT 	<p>1. Test equipment connection is shown in fig. 22.</p>  <p style="text-align: center;">Fig. 22</p> <p>2. Set the peak check switch to the "METER" position.</p> <p>3. Supply 1 kHz signal from the AF oscillator, through the ATT, to the LINE IN jack.</p> <p>4. Adjust ATT so that the monitor level at LINE OUT becomes 0.42 V.</p> <p>5. Adjust VR11 (L-CH) and VR12 (R-CH) so that the level meters indicate 0 dB.</p> <p>6. Set the peak check switch to the "IND" position.</p> <p>7. Then adjust VR13 for R-CH so that left and right level meters show the same indication.</p>	<ul style="list-style-type: none"> * Record mode * LINE IN level control ... MAX * Output level control ... MAX

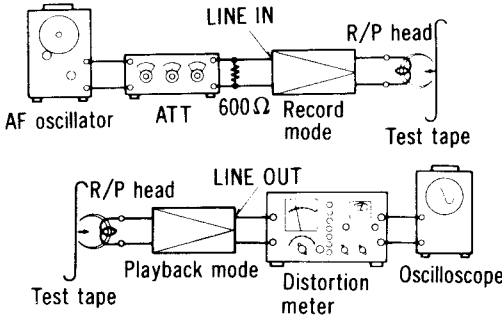
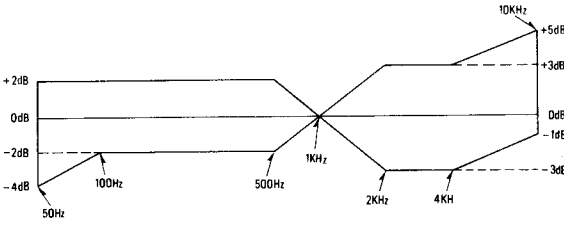
ITEM	MEASUREMENT & ADJUSTMENT	REMARKS
<p>Overall distortion</p> <p>Equipment:</p> <ul style="list-style-type: none"> * Distortion meter * AF oscillator * ATT * Oscilloscope * Test tape (reference blank tape) <li style="padding-left: 20px;">... QZZCRA for Normal <li style="padding-left: 20px;">... QZZCRX for CrO₂ 	<p>1. Test equipment connection is shown in fig. 23.</p> <div style="text-align: center;">  <p>Fig. 23</p> </div> <p>2. Supply 1kHz signal to LINE IN and adjust ATT so that output level at LINE OUT indicates 0.42 V (−7 dB).</p> <p>3. Make recording.</p> <p>4. Playback and measure distortion factor of output signal.</p> <p>5. When the distortion factor does not satisfy the standard, check the bias current. When the bias current is lower than standard, distortion will increase.</p> <p>Care should be exercised in the adjustment because the bias current also has an influence on the overall frequency response. Refer to "The overall frequency response" and "The bias current adjustment".</p> <div style="border: 1px solid black; padding: 5px; width: fit-content; margin: 10px auto;"> <p>Standard value: Less than 2.5% (Normal) Less than 4.0% (CrO₂)</p> </div>	<ul style="list-style-type: none"> * Record/playback mode * LINE IN level control ... MAX * Output level control ... MAX
<p>Overall frequency response</p> <p>Equipment:</p> <ul style="list-style-type: none"> * VTVM * AF oscillator * ATT * Test tape (reference blank tape) <li style="padding-left: 20px;">... QZZCRA for Normal <li style="padding-left: 20px;">... QZZCRX for CrO₂ 	<p>Note:</p> <p>Before measuring, and adjusting, make sure of the playback frequency response (For the method of measurement, please refer to the playback frequency response).</p> <ol style="list-style-type: none"> 1. Test equipment connection is shown in fig. 21. 2. Load reference blank test tape and place UNIT into record mode. 3. Supply 1kHz signal from AF oscillator through ATT to LINE IN. 4. Adjust ATT so that input level is −20 dB below standard recording level (standard recording level = 0 VU). 5. At this time, LINE OUT level indicates 0.042 V. 6. Record each frequency 50 Hz, 100 Hz, 200 Hz, 1 kHz, 2 kHz, 4 kHz and 10 kHz (12 kHz for CrO₂ tape) at the same level. 7. Playback and express in dB the difference between playback output level of each frequency based on playback output level of 1 kHz. 8. Make sure that the measured value is within the range specified in the overall frequency response chart. <div style="text-align: center;"> <p>Overall frequency response chart (Normal)</p>  <p>Fig. 24</p> </div>	<ul style="list-style-type: none"> * Record/playback mode * LINE IN level control ... MAX * Output level control ... MAX

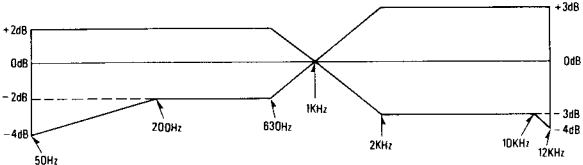
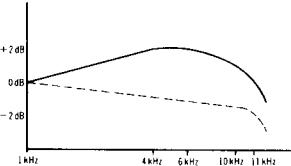
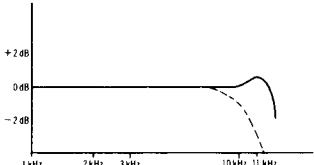
ITEM	MEASUREMENT & ADJUSTMENT	REMARKS
	<p>9. Set the bias selector to CrO₂ position. 10. Measure as same as manner above. 11. Make sure that the measured value is within the range specified in the overall frequency response chart for CrO₂ tape below.</p> <p style="text-align: center;">Overall frequency response chart (CrO₂)</p>  <p style="text-align: center;">Fig. 25</p>	
<p>Overall frequency response adjustment (As a standard for adjustment)</p>	<p>Adjustment 1—Using bias current</p> <ol style="list-style-type: none"> When the frequency response between the middle- and high-frequency range becomes higher than the standard value, as shown by the solid line in fig. 26, increase the bias current by turning VR15 (L-CH), VR16 (R-CH). When it becomes lower, as shown by dotted line, reduce the bias current by turning VR15 (L-CH), VR16 (R-CH). <p>Note:</p> <ol style="list-style-type: none"> For adjustment when the bias current is lower than the standard value use the procedure indicated in adjustment 2, because reducing the bias current beyond this point may worsen the distortion factor. For the method of bias current measurement, refer to "Bias current adjustment" on page 6.  <p style="text-align: center;">Fig. 26</p> <p>Adjustment 2—Using the peaking coil for recording equalization</p> <p>When the frequency response is flat in the middle-frequency range and makes a sharp rise or drop in the high-frequency range, as shown in fig. 27, adjust by turning the peaking coil L3 (L-CH), L4 (R-CH) for normal tape recording equalization.</p>  <p style="text-align: center;">Fig. 27</p>	
<p>Dolby NR circuit Equipment: * VTVM * AF oscillator * ATT * Oscilloscope</p>	<ol style="list-style-type: none"> Place UNIT into record mode, set the Dolby NR switch to OUT position and supply to LINE IN to obtain -34.5dB at TP3 (L-CH), TP4 (R-CH) (frequency 5kHz). Confirm that the value at IN position is 8(±2.5)dB greater than the value at OUT position of Dolby NR switch. 	<p>* Record mode * LINE IN level control ... MAX</p>

ITEM	MEASUREMENT & ADJUSTMENT	REMARKS
Overall S/N ratio Equipment: * VTVM * AF oscillator * ATT * Oscilloscope * Test tape (reference blank tape) ... QZZCRA	1. Test equipment connection is shown in fig. 21. 2. Supply 1kHz signal to LINE IN and adjust ATT so that output level at LINE OUT indicates 0.42V (-7dB). 3. Make recording. 4. Make another recording without supplying signal (disconnect input plug to LINE IN). 5. Rewind to recorded part and playback. 6. Measure output signal level and no signal level (noise), and determine the ratio in decibels (dB). 7. The value is difference between "Playback S/N and overall S/N", but for decibel calculation refer to "Playback S/N measurement" on page 5.	* Record/playback mode * LINE IN level control ... MAX * Output level control ... MAX * Erase the tape with a bulk tape eraser.
	<div style="border: 1px solid black; padding: 5px; width: fit-content; margin: auto;"> Standard value: Greater than 40dB (without NAB filter) </div>	

HOW TO INSTALL THE RECORD-MUTING SWITCH

1. Lock the record button, and then mount it with screw (B) so that the cap and micro switch (A) do not contact each other.
2. Then play the music tape. During the playback, press the record button lightly several times, confirm whether the playback sound is interrupted or not.

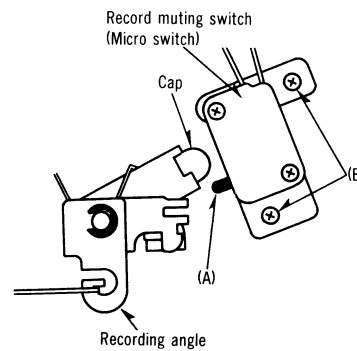

ADJUSTMENT PARTS LOCATION

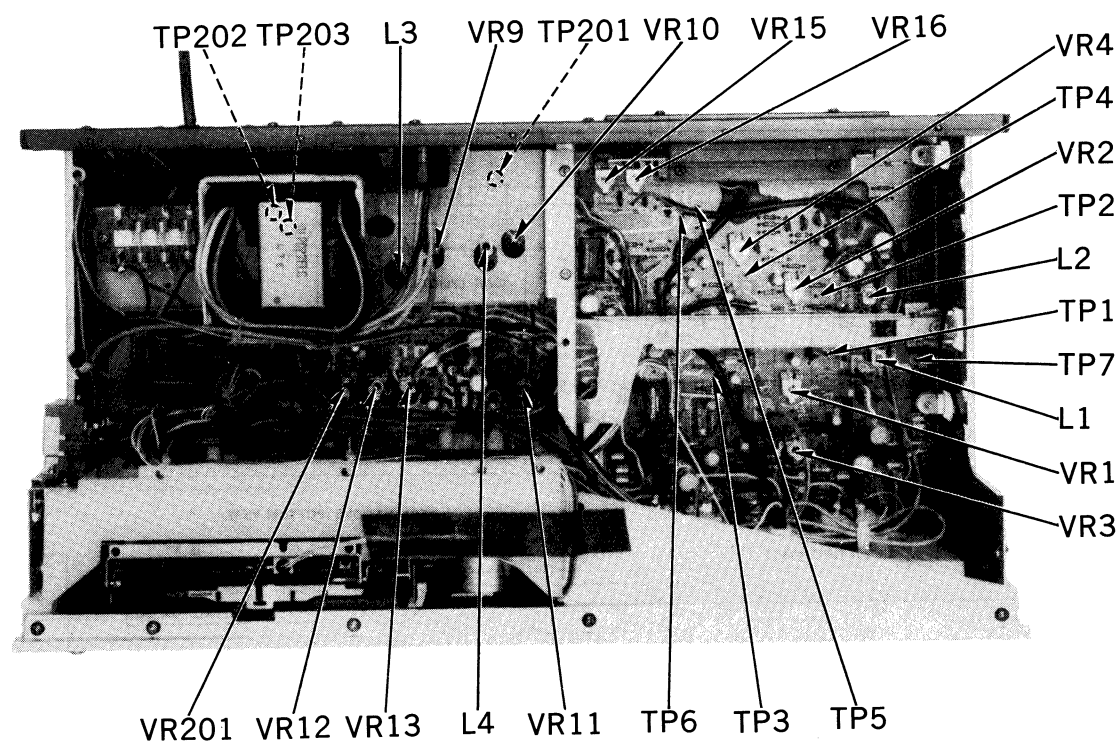
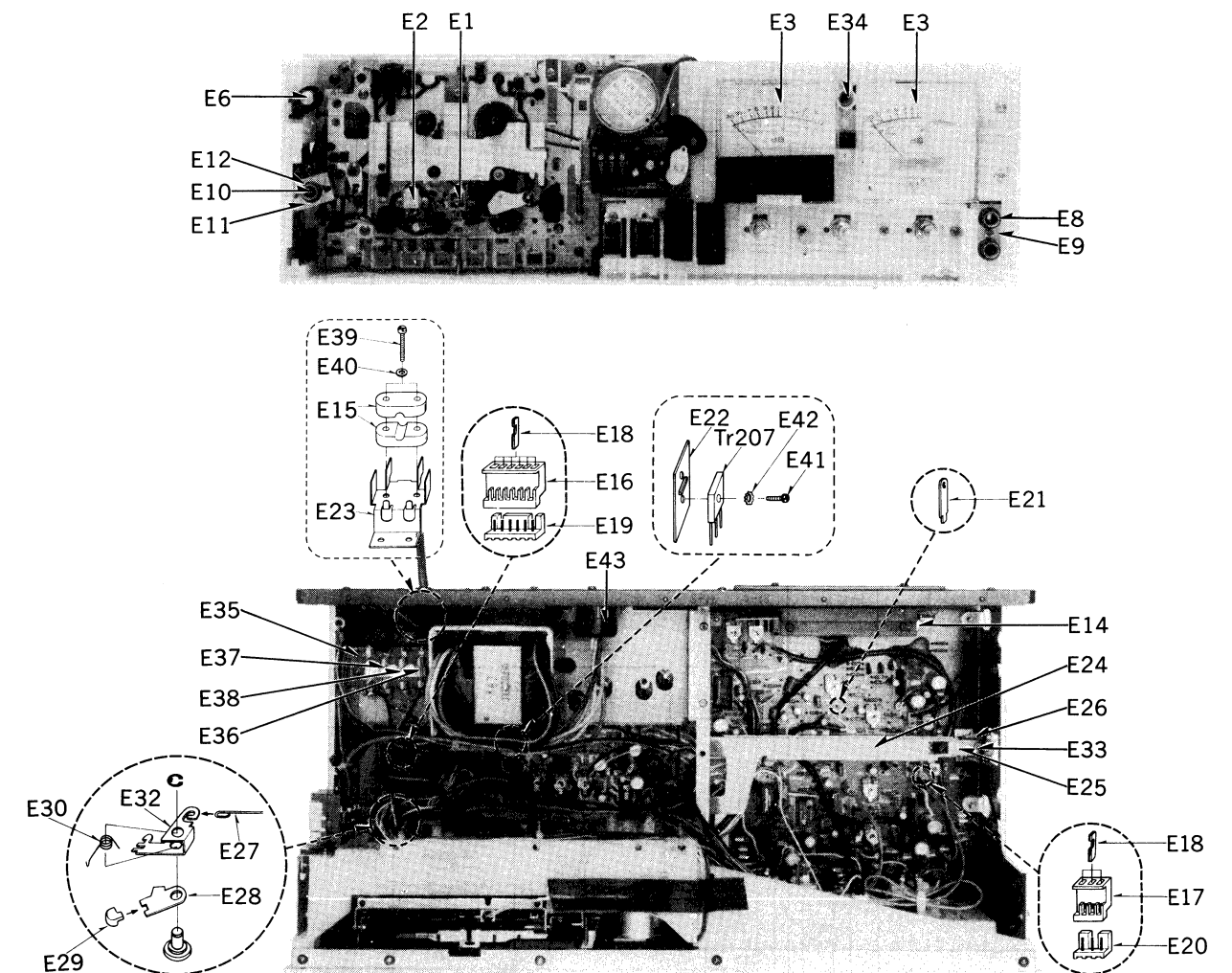

Fig. 28

ELECTRICAL PARTS LOCATION



NOTE:

1. Symbols after Ref. No. indicate: ▲ for Scandinavia, ● for United Kingdom.
2. [S] indicates that only parts specified by the manufacturer be used for safety.

Ref. No.	Part No.	Part Name & Description	Ref. No.	Part No.	Part Name & Description
E1	WY456Z	Record/Playback Head	E21	QJT0053	Check Pin
E2	QWY2122Z	Erase Head	E22	QTH1118	Heat Sink
E3	QSL9010RNM	Level Meter with Pilot Lamp	E23	QMA3370	Cord Angle
E4 ●	QFC1204M	AC Power Cord	E24	QMA3202	Switch Lever
E4 ▲	QFC1205M	"	E25	QMA3208	Friction Metal
E5	QBJ1425	Power Cord Bushing	E26	QBT1787	Lock Lever Spring
E6	QXB0531	Push Button (Power Switch)	E27	QBS1115	Recording Connection Wire
E7	QMA3204	Power Switch Angle	E28	QMA3247	Muting Detection Lever
E8	QJA0444	Microphone Jack	E29	QMF1692	Cap
E9	QMA3229	Microphone Jack Angle	E30	QBN1558	Muting Return Spring
E10	QJA0249	Headphones Jack	E31	QMA3257	Micro Switch Holding Plate
E11	QMA3205	Headphones Jack Angle	E32	QMA3203	Recording Angle
E12	QMQ1070	Nut	E33	XSNQ0004S	Step Screw
E13	QEJ5002HA	Jack Board Assembly	E34	QBG1222	Pilot Lamp Cover
E14	QMA3207	Jack Board Angle	E35	QTF1039	Fuse Holder
E15	QTD1164	Power Cord Clamper	E36	XBAQ0003	Fuse (500mA)
E16	QJS1922TN	6 Pin Housing	E37	XBAQ0008	Fuse (630mA)
E17	QJS1921TN	3 Pin Housing	E38	XBAQ0007	Fuse (400mA)
E18	QJT1054	Contact	E39	XSN3+25	Screw @3x25
E19	QJP1922TN	6 Pin Post	E40	XWA3B	Spring Washer 3φ
E20	QJP1921TN	3 Pin Post	E41	XSN26+6	Screw @2.6x6
			E42	XWC26B	Lock Washer 2.6φ
			E43	RUV387ZB	Switch Cover

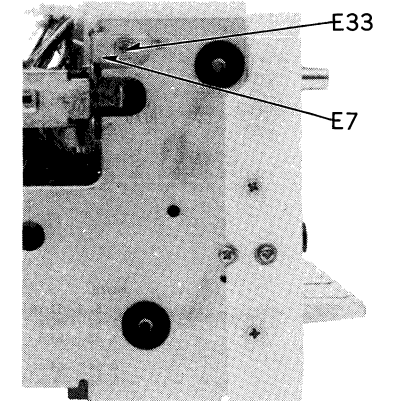

SCHEMATIC DIAGRAM MODEL RS-631

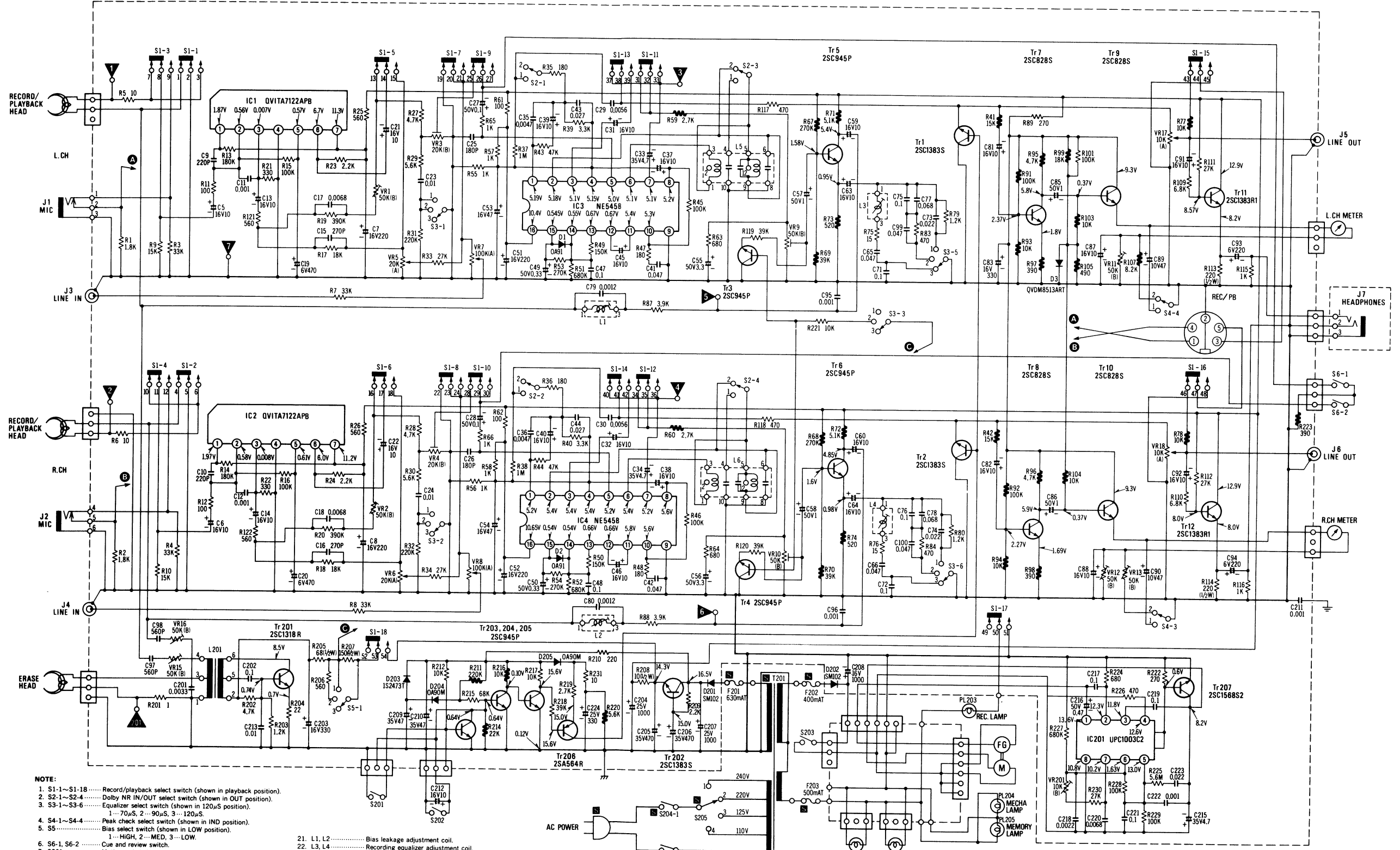

- NOTE:**
- S1-1~S1-18 Record/playback select switch (shown in playback position).
 - S2-1~S2-4 Dolby NR IN/OUT select switch (shown in OUT position).
 - S3-1~S3-6 Equalizer select switch (shown in 120μS position).
1...70μS, 2...90μS, 3...120μS.
 - S4-1~S4-4 Peak check select switch (shown in IND position).
 - S5 Bias select switch (shown in LOW position).
1...HIGH, 2...MED, 3...LOW.
 - S6-1, S6-2 Cue and review switch.
 - S201 Muting switch for record and playback.
 - S202 Muting switch for record.
 - S203 Motor ON/OFF switch.
 - S204 Power ON/OFF switch.
 - VR1, VR2 Playback equalizer adjustment VR.
 - VR3, VR4 Playback gain adjustment VR.
 - VR5, VR6 Microphone input level control.
 - VR7, VR8 LINE IN input level control.
 - VR9, VR10 Recording gain adjustment VR.
 - VR11, VR12 Peak meter indication adjustment VR.
 - VR13 Level meter balance adjustment VR.
 - VR15, VR16 Bias current adjustment VR.
 - VR17, VR18 Output level control.
 - VR201 Tape speed adjustment VR.

- L1, L2 Bias leakage adjustment coil.
- L3, L4 Recording equalizer adjustment coil.
- Resistor values are in ohms (Ω), 1/4 watt unless specified otherwise. K=1,000Ω.
- Capacitor values are in microfarads (μF) unless specified otherwise. P=Pico-farads.
- All voltage values shown in circuitry are under no signal condition with volume control at minimum position.
- For measurement, use VTVM.
- The mark (▼) shows test point. e.g. ▼=Test point 1.

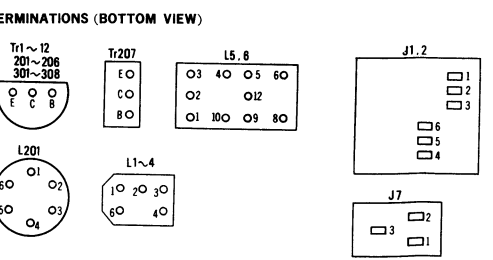
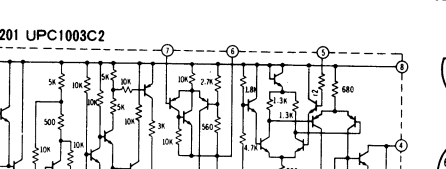
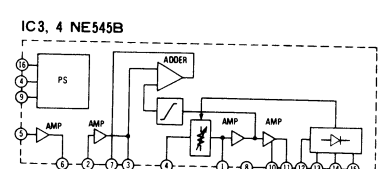
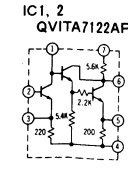

CIRCUIT BOARD

MAIN CIRCUIT BOARD

NOTE: 1. Symbols after Ref. No. indicate:
 ● for Scandinavia.
 ▲ for United Kingdom.
 2. S indicates that only parts specified by the manufacturer be used for safety.

Ref. No.	Part No.	Part Name & Description	Ref. No.	Part No.	Part Name & Description	Ref. No.	Part No.	Part Name & Description
TRANSFORMERS			SWITCHES			S203	QSB0178	Leaf Switch (Motor ON/OFF)
T201	QLPD27ELC	Power Transformer	S1	QSSI202	Slide Switch (Record/Playback Selector)	S204	QSW2214	Push Switch (Power ON/OFF)
T201	QLPA37ELC	"	S2	QST4215	Lever Switch (Dolby IN/OUT Selector)	S205	QSR1407	Rotary Switch (AC Voltage Selector)
COILS			PILOT LAMPS			PL201	XAMQ35	Level Meter Lamp
L1, 2, 3, 4	QLQM0333	Coil	S3	QST6311	Lever Switch (EQ Selector)	PL202	XAMQ35	"
L5, 6	QLM923K	MPX Trap Coil	S4	QST4215	Lever Switch (Peak Check Selector)	PL203	XAMQ22P500N	Pilot Lamp (for Record)
L201	QLB0155	Oscillator Coil	S5	QST6311	Lever Switch (Bias Selector)	PL204	XAMQ34S600W	Pilot Lamp (for Mechanism)
			S6	QSB0186	Leaf Switch (Cue/Review Switch)	PL205	XAMQ21P400N	Pilot Lamp (for Memory)
			S201	QSB0178	Leaf Switch (Muting Switch)			
			S202	QSM0070	Micro Switch (Muting Switch)			

NOTE: RESISTORS ERDCarbon
 ERGMetal oxide
 CAPACITORS ECEAElectrolytic
 ECCDCeramic
 ECKDCeramic
 EQQMPolyester
 ECQSPolystyrene

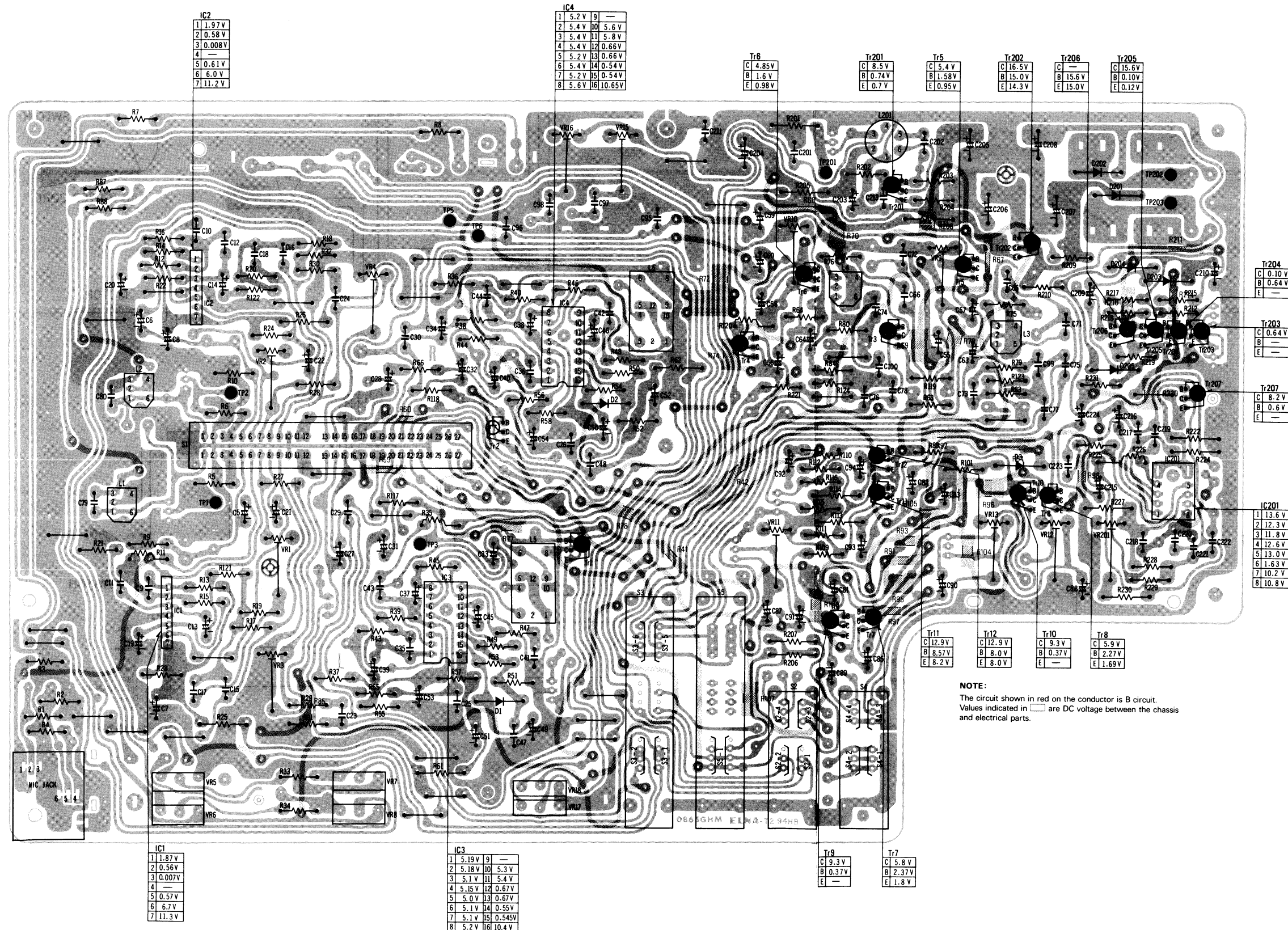

Ref. No.	Part No.	Ref. No.	Part No.
RESISTORS			
R1, 2	ERD25TJ182	VR9, 10, 11, 12, 13, 15, 16	EWKN3AF21A24
R3, 4	ERD25TJ333	VR7, 8	EWKN3AF21A15
R5, 6	ERD25TJ100	VR17, 18	EWK9KA025A14
R7, 8	ERD25TJ333	VR201	EVL33AA00B14
R9, 10	ERD25TJ153	CAPACITORS	
R11, 12	ERD25TJ101	C5, 6	ECEA16Z10
R13, 14	ERD25TJ184	C7, 8	ECEA16V220
R15, 16	ERD25TJ104	C9, 10	ECCD1H221K
R17, 18	ERD25TJ183	C11, 12	ECKD1H102MD
R19, 20	ERD25TJ394	C13, 14	ECEA16V10
R21, 22	ERD25TJ331	C15, 16	ECCD1H271K
R23, 24	ERD25TJ222	C17, 18	ECKD1H682MD
R25, 26	ERD25TJ561	C19, 20	ECEA6V470
R27, 28	ERD25TJ472	C21, 22	ECEA16V10
R29, 30	ERD25TJ562	C23, 24	EQQM05103KZ
R31, 32	ERD25TJ224	C25, 26	ECCD1H181K
R33, 34	ERD25TJ273	C27, 28	ECEA50Z1R
R35, 36	ERD25TJ181	C29, 30	EQQM05562JZ
R37, 38	ERD25TJ105	C31, 32	ECEA16V10
R39, 40	ERD25TJ332	C33, 34	ECEA35Z4R7
R43, 44	ERD25TJ473	C35, 36	EQQM05472JZ
R45, 46	ERD25TJ104	C37, 38, 39, 40	ECEA16V10
R47, 48	ERD25TJ181	C41, 42	EQQM05473KZ
R49, 50	ERD25TJ154	C43, 44	EQQM05273JZ
R51, 52	ERD25TJ684	C45, 46	ECEA16V10
R53, 54	ERD25TJ274	C47, 48	EQQM05104KZ
R55, 56, 57, 58	ERD25TJ102	C49, 50	ECEA50Z3R3
R61, 62	ERD25TJ101	C51, 52	ECEA16V220
R63, 64	ERD25TJ681	C53, 54	ECEA16V47
R65, 66	ERD25TJ102	C55, 56	ECEA50Z3R3
R75, 76	ERD25TJ150	C57, 58	ECEA50Z1
R79, 80	ERD25TJ122	C59, 60, 63, 64	ECEA16V10
R83, 84	ERD25TJ471	C65, 66	EQQM05473KZ
R87, 88	ERD25TJ392	C71, 72	EQQM05104KZ
R89	ERD25TJ271	C73, 74	EQQM05223KZ
R101	ERD25TJ104	C75, 76	EQQM05104KZ
R109, 110	ERD25TJ682	C77, 78	EQQM05683KZ
R111, 112	ERD25TJ273	C79, 80	EQQM05122KZ
R113, 114	ERG12ANJ221	C81, 82	ECEA16V10
R115, 116	ERD25TJ102	C83	ECEA16V330
R117, 118	ERD25TJ471	C85, 86	ECEA50V1
R119, 120	ERD25TJ393	C87, 88	ECEA16V10
R121, 122	ERD25TJ561	C89, 90	ECEA16V47
R201	ERD25TJ1R0	C91, 92	ECEA16V10
R202	ERD25TJ472	C93, 94	ECEA6V220
R203	ERD25TJ122	C95, 96	EQQM05102KZ
R204	ERD25TJ220	C97, 98	ECKD1H561KB
R205	ERG12ANJ680	C99, 100	EQQM05473KZ
R206	ERD25TJ561	C201	ECQS1332KZ
R207	ERG12ANJ151	C202	EQQM05104KZ
R208	ERG12ANJ100	C203	ECEA16V330
R209	ERD25TJ222	C204	ECEA25V1000
R210	ERD25TJ221	C205, 206	ECEA35V470
R212	ERD25TJ103	C207	ECEA25V1000
R215	ERD25TJ683	C208	ECEA16V1000
R217	ERD25TJ103	C209, 210	ECEA35V47
R218	ERD25TJ393	C211	ECKD1H102MD
R219	ERD25TJ272	C212	ECEA16M10
R221	ERD25TJ103	C213	ECKD1H103ZF
R222	ERD25TJ271	C215	ECEA35V4R7
R224	ERD25TJ681	C216	ECEA50Z4R7
R225	ERC14GK565	C217	EQQM05104KZ
R226	ERD25TJ471	C218	EQQM05222KZ
R227	ERD25TJ684	C219	EQQM05104KZ
R228, 229	ERD25TJ104	C220	EQQM05682JZ
R230	ERD25TJ273	C221	EQQM05104KZ
R231	ERD25TJ100	C222	EQQM05102KZ
VARIABLE RESISTORS			
VR1, 2	EVL33AA00B54	C223	EQQM05223KZ
VR3, 4	EVL33AA00B24	C224	ECEA25V330

NOTE:
 The circuit shown in red on the conductor is B circuit.
 Values indicated in □ are DC voltage between the chassis and electrical parts.

WIRING CONNECTION DIAGRAM MODEL RS-631

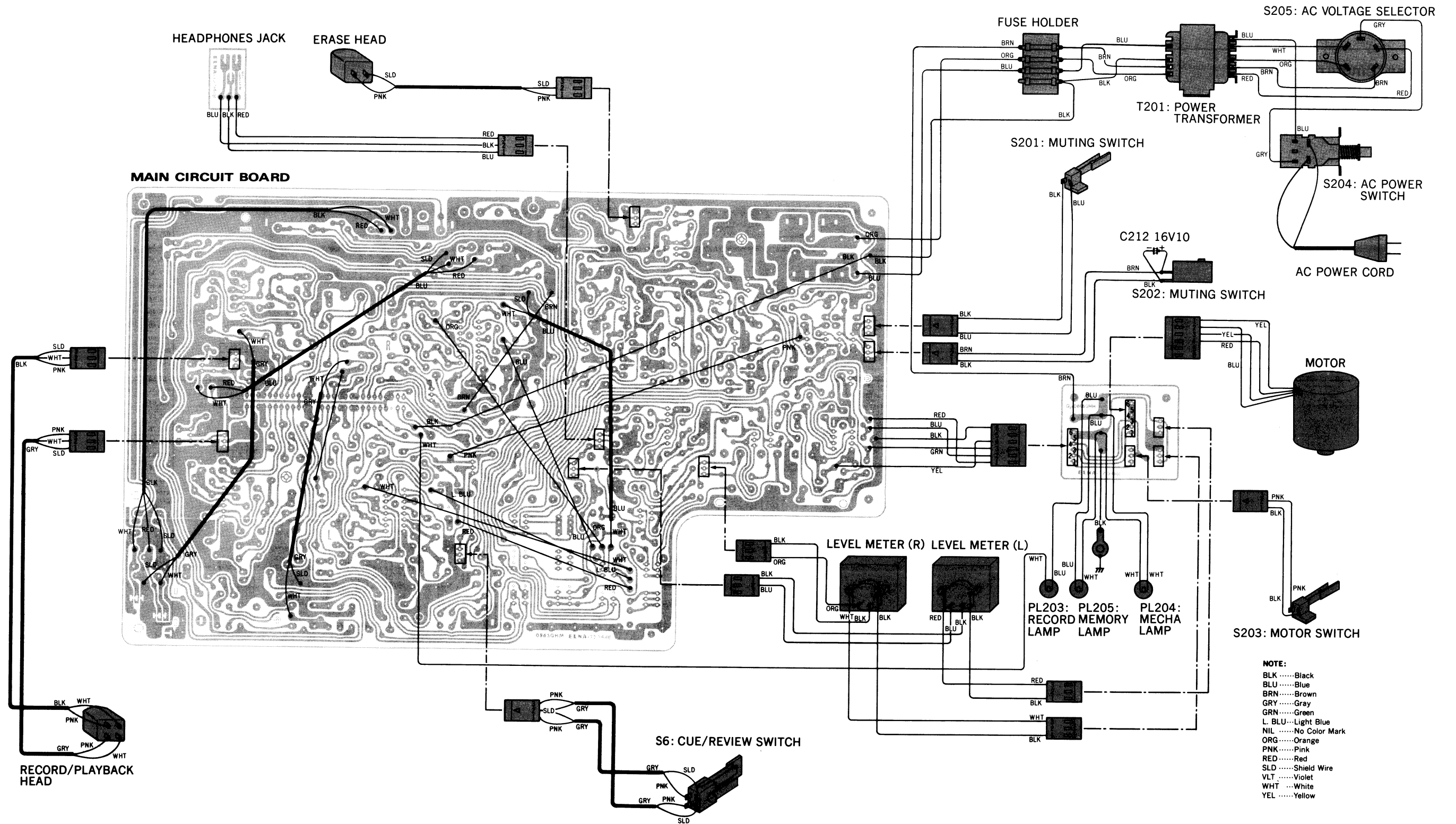

EXPLODED VIEWS

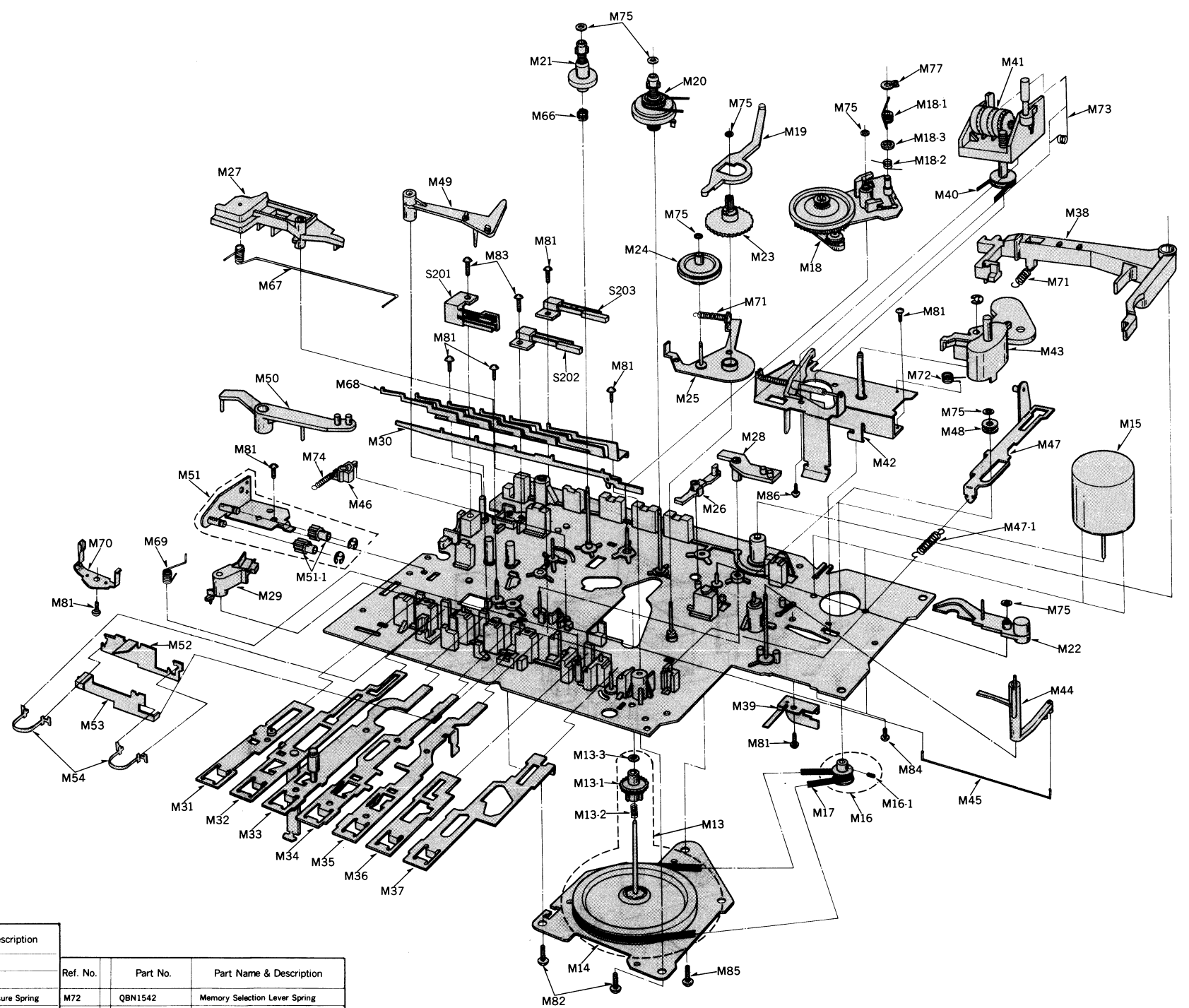
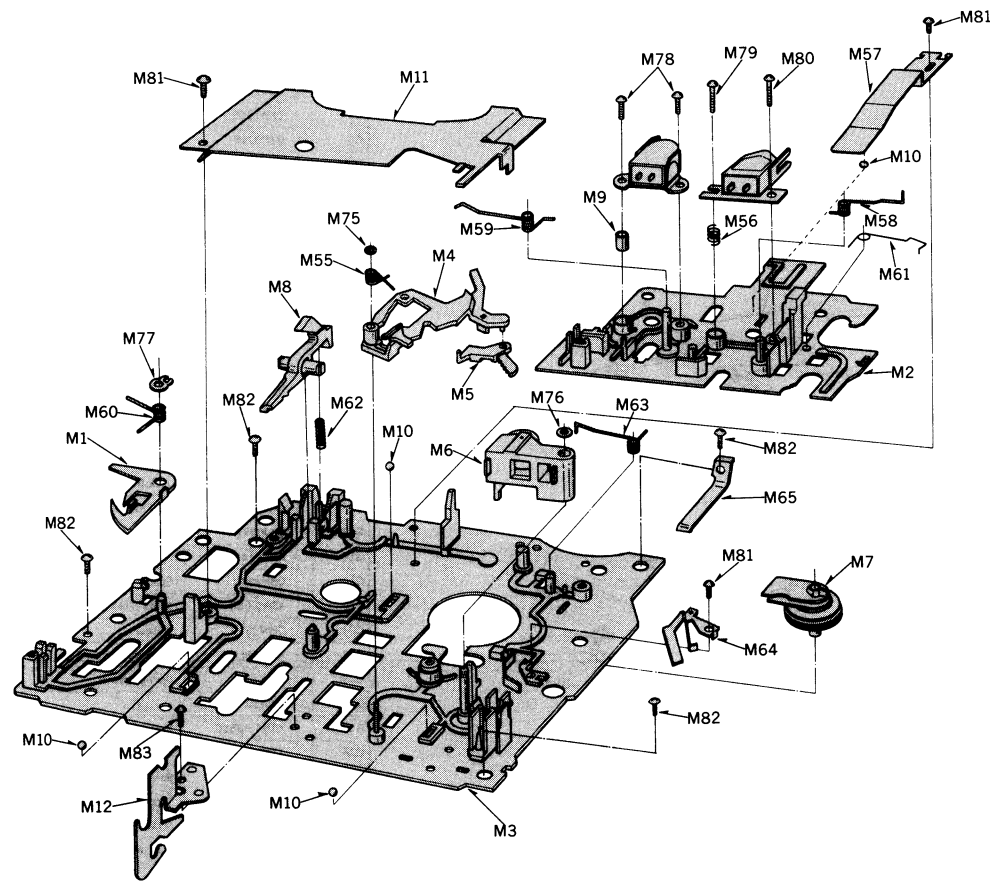

Ref. No.	Part No.	Part Name & Description	Ref. No.	Part No.	Part Name & Description
M1	QML2898	Pause Lock Plate	M26	QML3042	Auto-Stop Obstruction Lever
M2	QMK1612	Head Base Plate	M27	QML3217	Pause Lever
M3	QXK1951	Upper Base Plate Assembly	M28	QML3049	Cue Lever
M4	QML3047	Obstruction Lever	M29	QML3124	Lock Release Arm
M5	QML3048	Driving Lever	M30	QXR0275	Lock Rod Assembly
M6	QXL1057	Pressure Roller Lever Assembly	M31	QXR0342	Pause Rod Assembly
M7	QX10098	Takeup Idler Assembly	M32	QXR0343	Record Rod Assembly
M8	QML3051	Erase Safety Lever	M33	QXR0344	Playback Rod Assembly
M9	QMC0061	Erase Head Spacer	M34	QMR1624	Rewind Rod-A
M10	QDK1012	Steel Ball 2.5φ	M35	QMR1623	Fast Forward Rod-A
M11	QMF1939	Chassis Cover-A	M36	QMR1622	Stop Rod-A
M12	QMA3186	Fulcrum Angle	M37	QMR1621	Eject Rod-A
M13	QXF0131	Flywheel	M38	QML3038	Switch Arm
M13-1	QDG1116	Capstan Gear	M39	QMA3173	Connection Wire Holding Angle
M13-2	QBC1301	Capstan Spring	M40	QDB0240	Counter Belt
M13-3	QBW2049	Washer	M41	QXC0017	Tape Counter
M14	QXH0272	Flywheel Retainer Assembly	M42	QXA0649	Counter Angle Assembly
M15	MHN8E2RSD	Motor	M43	QXL1135	Memory Selection Lever (for Silver Face Unit)
M16	QXP0567	Motor Pulley Assembly	(M43)	QXL1151	Memory Selection Lever (for Black Face Unit)
M16-1	XSN2+3	Screw φ2×3	M44	QML3205	Connection Lever
M17	QDB0241	Flywheel Belt	M45	QBS1113	Connection Wire
M18	QXL1136	Fast Forward Arm Assembly	M46	QMD0016	Rewind Brake Cam
M18-1	QBN1517	Fast Forward Spring	M47	QXR0345	Eject Rod-B
M18-2	QBN1559	Fast Forward Arm Spring	M47-1	QBT1619	Idler Spring
M18-3	QMC0080	Collar	M48	QBJ2088	Counter Pulley
M19	QML3040	Cam Lever	M49	QML3206	Muting Arm
M20	QXD0067	Takeup Reel Table Assembly	M50	QML3207	Muting Lever
M21	QXD0084	Supply Reel Table Assembly	M51	QXG1031	Damper Gear Assembly
M22	QXL1055	Auto-Stop Lever Assembly	M51-1	QDG1102	Holder Gear
M23	QDG1096	Cam Gear	M52	QMR1628	Obstruction Rod-A
M24	QXG1026	Auto-Stop Gear Assembly	M53	QMR1629	Obstruction Rod-B
M25	QXL1037	Gear Lever Assembly	M54	QBP1770	Obstruction Rod Spring

Ref. No.	Part No.	Part Name & Description
M55	QBN1515	Connection Spring
M56	QBC1278	Head Spring
M57	QBP1773	Head Base Plate Pressure Spring
M58	QBN1488	Pressure Roller Spring
M59	QBN1481	Playback Spring
M60	QBN1480	Pause Lock Spring
M61	QBN1514	Timer Spring
M62	QBC1193	Safety Lever Spring
M63	QBN1513	Idler Spring
M64	QBP1723	Click Spring
M65	QBP1777	Holder Reinforcement Spring
M66	QBC1279	Back Tension Spring
M67	QBN1555	Pause Spring
M68	QBP1664	Operation Rod Spring
M69	QBN1531	Lock Release Arm Spring
M70	QBP1662	Lock Rod Spring
M71	QBT1682	Lock Holding Spring

Ref. No.	Part No.	Part Name & Description
M72	QBN1542	Memory Selection Lever Spring
M73	QBN1543	Reset Reinforcement Spring
M74	QBT1833	Brake Cam Spring
M75	QBW2008	Snap Washer
M76	QBW2046	"
M77	XUB4FT	Stop Ring C4φ
M79	QH01226	Screw
M80	XSN2+10	Screw φ2×10
M81	XTN26+5B	Tapping Screw φ2.6×5
M82	XTN3+10B	Tapping Screw φ3×10
M83	XTN26+8B	Tapping Screw φ2.6×8
M84	XSN26+3	Screw φ2.6×3
M85	XTN3+20B	Tapping Screw φ3×20
M86	XSN3+5S	Screw φ3×5

CABINET PARTS

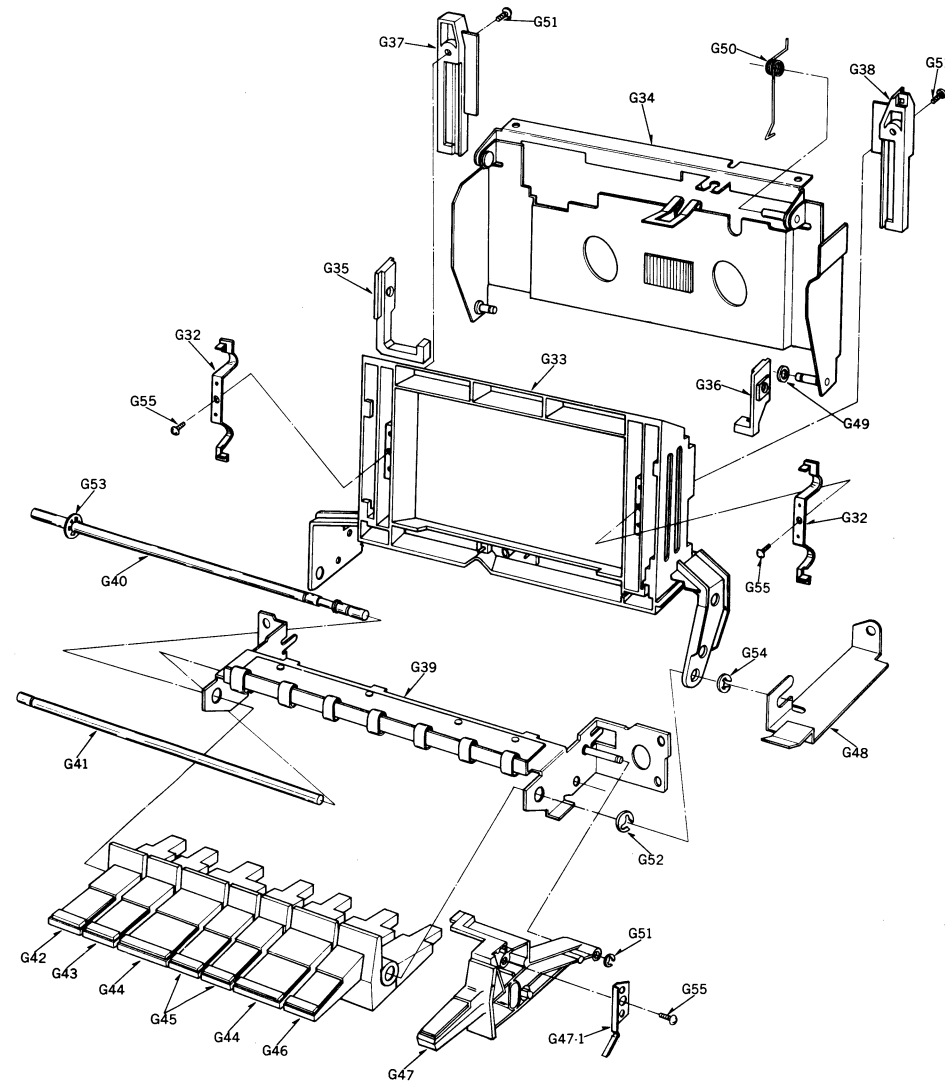
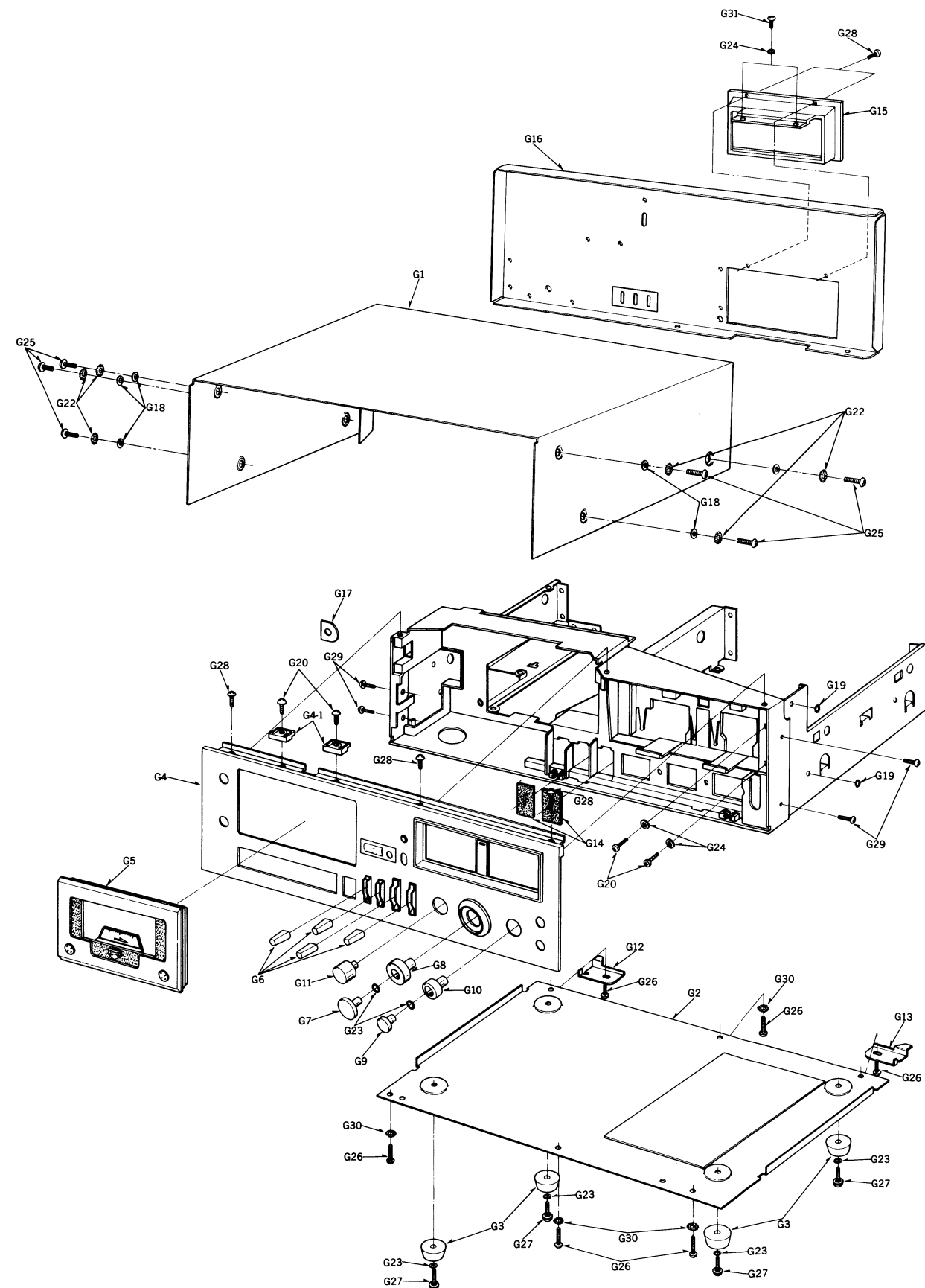

ACCESSORIES

NOTE: Symbols after Ref. No. indicate:
 ▲...for Scandinavia.
 ●...for United Kingdom.

Ref. No.	Part No.	Part Name & Description
A1	RP023A	Connection Cord
A2	QFT6TCJNTBFZ	Demonstration Tape
A3 ▲	QQT2227	Instruction Book
A3 ●	QQT2228	"

PACKINGS

Ref. No.	Part No.	Part Name & Description
P1	QPN3651	Inside Carton
P2	QPA0331	Inner Cushion
P3	XZB50X65A05	Poly Bag
P4	QPA0340	Spacer
P5	QPS0285	Pad

NOTE: Symbols after Ref. No. indicate:
 ▲...for Scandinavia.
 ●...for United Kingdom.

Ref. No.	Part No.	Part Name & Description
G1 ▲	QGC1079	Case Cover
G1 ●	QGC1086	"
G2	QGC1080	Bottom Cover
G3	QKA1065	Rubber Foot
G4	QYP0715	Front Panel Assembly (for Silver Face Unit)
(G4)	QYP0716	Front Panel Assembly (for Black Face Unit)
G4-1	QKJ0235	Stopper
G5	QYF0308	Cassette Lid Assembly (for Silver Face Unit)
(G5)	QYF0309	Cassette Lid Assembly (for Black Face Unit)
G6	QYT0461	Lever Knob
G7	QYT0458	Volume Knob-A
G8	QYT0457	Volume Knob-B
G9	QYT0459	Volume Knob-C
G10	QYT0460	Volume Knob-D
G11	QYT1387	Volume Knob-E
G12	QMA3261	Reinforcement Angle-A
G13	QMA3262	Reinforcement Angle-B
G14	QBH0060	Spacer
G15	QGK2769	Jack Board Ornament
G16	QGC1092	Back Cover
G17	QKJ0237	Headphones Spacer
G18	QBK7143	Fiber Washer
G19	QBH2040	Spacer
G20	XSN3+8S	Screw $\varnothing 3 \times 8$
G21	QBW2023	Washer
G22	XWC4BFN	Lock Washer
G23	XWA4B	Spring Washer
G24	XWA3B	"
G25	XSN4+8BVS	Screw $\varnothing 4 \times 8$
G26	XTN3+14B	Tapping Screw $\varnothing 3 \times 14$
G27	XSN4+10S	Screw $\varnothing 4 \times 10$
G28	XTN3+10B	Tapping Screw $\varnothing 3 \times 10$
G29	XSS3+6S	Screw $\varnothing 3 \times 6$
G30	XWC3B	Lock Washer
G31	XSN3+8S	Screw $\varnothing 3 \times 8$
Cassette Holder Section		
G32	QBP1771	Holder Spring
G33	QKF6008	Cassette Holder
G34	QXH0271	Chassis Cover Assembly
G35	QKF6010	Holder Piece-L
G36	QKF6009	Holder Piece-R
G37	QMG0050	Holder Slider-L
G38	QMG0049	Holder Slider-R
G39	QXA0637	Push Button Holding Angle
G40	QMN2240	Push Button Shaft-A
G41	QMN1861	Push Button Shaft-B
G42	QGO1370	Push Button (PAUSE)
G43	QGO1371	Push Button (REC)
G44	QGO1373	Push Button (PLAY, STOP)
G45	QGO1374	Push Button (FF, REW)
G46	QGO1372	Push Button (EJECT)
G47	QXB0508	Timer Button Assembly
G47-1	QBP1774	Timer Button Spring
G48	QMA3269	Reinforcement Angle
G49	QBW2017	Washer
G50	QBN1554	Chassis Cover Spring
G51	XUC25FT	Stop Ring 2.5 ϕ
G52	XUC4FT	Stop Ring 4 ϕ
G53	QNO1080	Stop Ring
G54	XUC3FT	Stop Ring 3 ϕ
G55	XTN26+5B	Screw $\varnothing 2.6 \times 5$
G56	XTN26+8B	Screw $\varnothing 2.6 \times 8$