

# Power Transistor (80V, 0.5A)

## 2SD1782K

### ●Features

#### 1) Low $V_{CE(sat)}$ .

$$V_{CE(sat)} = 0.2V \text{ (Typ.)}$$

$$(I_C / I_B = 0.5A / 50mA)$$

#### 2) High $V_{CEO}$ , $V_{CEO} = 80V$

#### 3) Complements the 2SB1198K.

### ●Structure

Epitaxial planar type

NPN silicon transistor

### ●External dimensions (Units: mm)

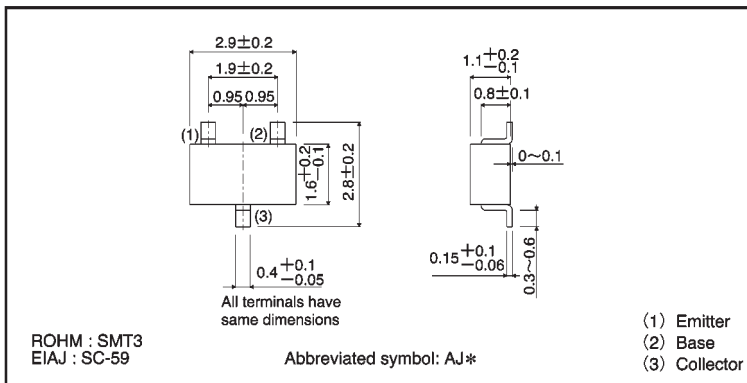

\* Denotes hFE

### ●Absolute maximum ratings ( $T_a = 25^\circ\text{C}$ )

Parameter	Symbol	Limits	Unit
Collector-base voltage	$V_{CBO}$	80	V
Collector-emitter voltage	$V_{CEO}$	80	V
Emitter-base voltage	$V_{EBO}$	5	V
Collector current	$I_C$	0.5	A
Collector power dissipation	$P_C$	0.2	W
Junction temperature	$T_j$	150	$^\circ\text{C}$
Storage temperature	$T_{stg}$	$-55 \sim +150$	$^\circ\text{C}$

●Electrical characteristics (Ta = 25°C)

Parameter	Symbol	Min.	Typ.	Max.	Unit	Conditions
Collector-base breakdown voltage	BV <sub>CB0</sub>	80	—	—	V	I <sub>c</sub> =50 μA
Collector-emitter breakdown voltage	BV <sub>CE0</sub>	80	—	—	V	I <sub>c</sub> =2mA
Emitter-base breakdown voltage	BV <sub>EB0</sub>	5	—	—	V	I <sub>E</sub> =50 μA
Collector cutoff current	I <sub>CBO</sub>	—	—	0.5	μA	V <sub>CB</sub> =50V
Emitter cutoff current	I <sub>EBO</sub>	—	—	0.5	μA	V <sub>EB</sub> =4V
Collector-emitter saturation voltage	V <sub>CE(sat)</sub>	—	0.2	0.5	V	I <sub>c</sub> /I <sub>B</sub> =500mA/50mA
DC current transfer ratio	h <sub>FE</sub>	120	—	390	—	V <sub>CE</sub> =3V, I <sub>c</sub> =100mA
Transition frequency	f <sub>T</sub>	—	180	—	MHz	V <sub>CE</sub> =10V, I <sub>E</sub> =-50mA, f=100MHz
Output capacitance	C <sub>ob</sub>	—	7.5	—	pF	V <sub>CB</sub> =10V, I <sub>E</sub> =0A, f=1MHz

●Packaging specifications and h<sub>FE</sub>

Type	h <sub>FE</sub>	Package	Taping
		Code	T146
		Basic ordering unit (pieces)	3000
2SD1782K	QR		○

h<sub>FE</sub> values are classified as follows :

Item	Q	R
h <sub>FE</sub>	120~270	180~390

●Electrical characteristic curves

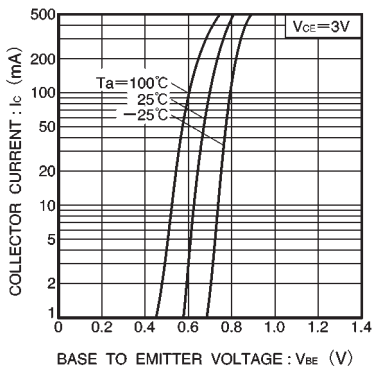

Fig.1 Grounded emitter propagation characteristics

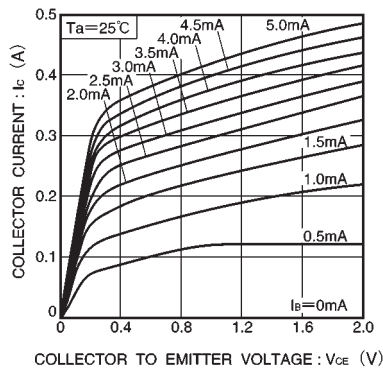

Fig.2 Grounded emitter output characteristics

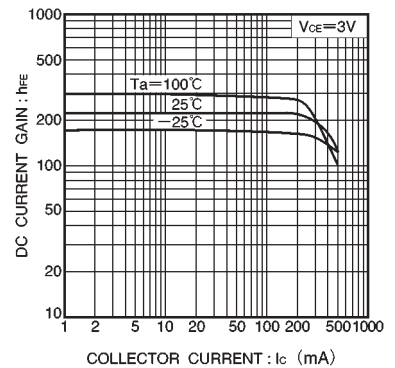

Fig.3 DC current gain vs. collector current

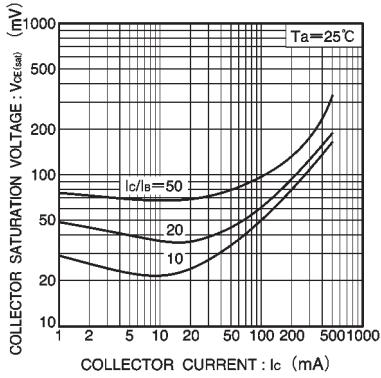

Fig.4 Collector-emitter saturation voltage vs. collector current ( I )

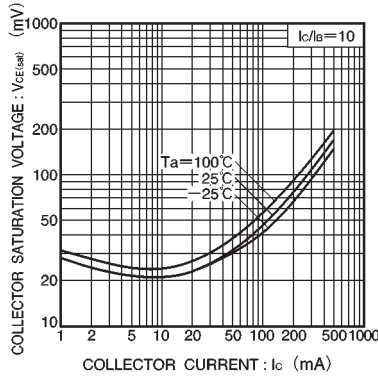

Fig.5 Collector-emitter saturation voltage vs. collector current ( II )

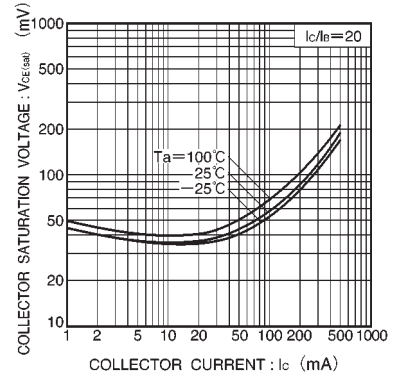

Fig.6 Collector-emitter saturation voltage vs. collector current ( III )

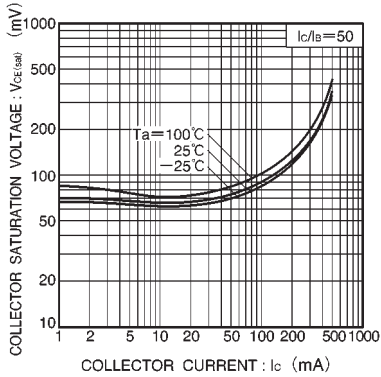

Fig.7 Collector-emitter saturation voltage vs. collector current ( IV )

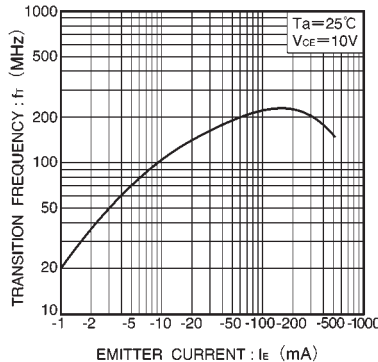

Fig.8 Gain bandwidth product vs. emitter current

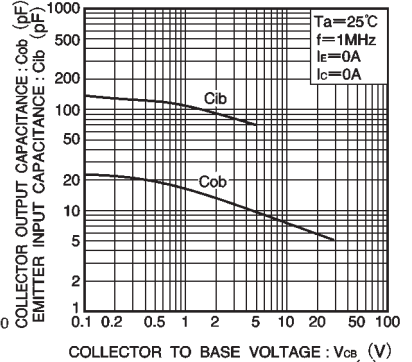

Fig.9 Collector output capacitance vs. collector-base voltage  
Emitter input capacitance vs. emitter-base voltage

This datasheet has been download from:

[www.datasheetcatalog.com](http://www.datasheetcatalog.com)

Datasheets for electronics components.