

# Service Manual

## Dishwasher integratable ADG 6966 IXM

| <b>Model<br/>Version</b> |                 | <b>Page</b>              |
|--------------------------|-----------------|--------------------------|
|                          | ADG 6966 IXM    |                          |
|                          | 8542 966 10750  |                          |
|                          | Technical data  | 2 - 4                    |
|                          | Spare part list | 5 - 6                    |
|                          | Exploded view   | 7 - 8                    |
|                          | Circuit diagram | 9                        |
|                          | Program diagram | 10                       |
|                          | Text/Legend     | 11 - 17                  |
|                          | Family          | VBL - HIGH 6<br>Sensor 2 |

**Technical data****Dimension**

|        |             |    |
|--------|-------------|----|
| Height | 82.0 - 87.0 | cm |
| Width  | 59.7        | cm |
| Depth  | 55.5        | cm |
| Weight | 50          | kg |

**Wooden door for Integrable types**

|  |     |    |
|--|-----|----|
| Thickness min.                                   | 16  | mm |
| Thickness max.                                   | 20  | mm |
| Width min.                                       | 592 | mm |
| Width max.                                       | 595 | mm |
| Height min.                                      | 515 | mm |
| Height max.                                      | 600 | mm |
| Weight max.                                      | 5.5 | kg |
| Max. stick out over lower edge of appliance door | 92  | mm |
| Height of plinth min.                            | 93  | mm |

**Electronic boards**

|   |                          |
|---|--------------------------|
| Service boards  | see spare part list      |
| Serial boards   | see on the boards itself |
| DUB   | 4619 724 04851           |
| Programing of version and programmed control board, see „Service“ and „Data set“ on rating plate of inner door: |                          |
| CB programmed   | 461643                   |
| Data set  | 461633                   |
| Basic control board, not programmed see on the board itself   | 4619 724 42092           |

**Succession of programs**

|            |                                   |
|------------|-----------------------------------|
| Programs   | see program diagram               |
| Succession | A1a - A2a - A3a - A5a - A8a - A9a |

**Datas Energy Label**

|                      |     |
|----------------------|-----|
| Reference program    | A5a |
| Energy Performance   | A   |
| Cleaning Performance | A   |
| Drying Performance   | A   |

**Alarms**

|                  |
|------------------|
| Refill rinse aid |
| Refill salt      |

**Options**

|                |
|----------------|
| Zone washing   |
| Delay function |

**Program information**

|                 |
|-----------------|
| Start indicator |
| Pre wash        |
| Main wash       |
| Drying          |
| End             |

All programs will be locked after start. Changing the program or finishing the program will be possible only after pressing the start button for longer then 1.5 sec. (Break by customer)

A switching off the appliance or unplug the appliance for a while, this will frozen the program step and later on, the program continuos on the same position.

Exception: Switching off the appliance or unplug the appliance during the drying phase, this will lead directly to the end of the program.

**Water Volume at alternating spray system**

Volume at alternating spray system (same level when selected zone washing as in the normal programs)

| Water                | Volume | Level  |
|----------------------|--------|--------|
| Regeneration         | 0.3 l  | 15 mm  |
| Back rinse 3x        | 1.0 l  | 60 mm  |
| Prewash              | 3.9 l  | 120 mm |
| Main wash            | 3.2 l  | 118 mm |
| Intermediate rinse 1 | 3.2 l  | 118 mm |
| Intermediate rinse 2 | 3.2 l  | 118 mm |
| Clear rinse          | 3.2 l  | 118 mm |
| Safety/ overflow     | 8.5 l  | 141 mm |

**Measuring the level**

Remove the coarse sieve, put in a measuring meter into the sump, measure the hight of the water level.

**Detergent max.**

|                |       |                 |
|----------------|-------|-----------------|
| Pre-wash       | 10    | cm <sup>3</sup> |
| Main-wash      | 40    | cm <sup>3</sup> |
| Rinse aid      | 135   | cm <sup>3</sup> |
| 6 Dosage steps | 1 - 6 | ml              |

**Water softener**

|                     |     |                 |
|---------------------|-----|-----------------|
| Saltcontainer       | 2   | kg              |
| Resin container     | 900 | cm <sup>3</sup> |
| Regeneration dosage | 300 | cm <sup>3</sup> |

## Technical data

### Water pressure

|                     |          |     |
|---------------------|----------|-----|
| Inlet pressure      | 0.3 - 10 | bar |
| Spray pump pressure | 0.3      | bar |

### Rotations

|                  |         |     |
|------------------|---------|-----|
| Spray pump motor | 2800    | RPM |
| Drain pump motor | 3000    | RPM |
| Spray arm lower  | 30 - 40 | RPM |
| Spray arm upper  | 30 - 40 | RPM |
| Fan for drying   | 2500    | RPM |

### Spray arms, turning rhythm at alternating spray system

Turning starts every time with the upper spray arm

|                      |                                    |
|----------------------|------------------------------------|
| Pre wash             | Lower arm ~3min, Upper arm ~1min   |
| Main wash            | Lower arm ~3min, Upper arm ~5min   |
| Intermediate rinse   | Lower arm ~2min, Upper arm ~2min   |
| Final rinse          | Lower arm ~2min, Upper arm ~2min   |
| Service Test program | Lower arm ~30sec, Upper arm ~30sec |

Remark: When switching of the main switch or interrupt the mains during the Test Program runs, then the alternating of the spray arms change in the test program to the rhythm of main wash 5/3 min.

Important: To leaf the Test program is possible by made a break by customer (pushing the start button for 1.5 sec.)

After finishing the test program (End LED shines and/or Start LED goes of) must the appliance be switched off.

If this will not be done, then the next normal wash will be made with the frequency of the Service Test Program ~30/30sec.

### Flow rates/ Inlet volume

|  |         |       |
|--|---------|-------|
| Flow meter (at 0.3 bar = quantity 1.1 l/min) | 208     | lmp/l |
| Spray pump                                   | 45 - 65 | l/min |
| Drain pump                                   | 16      | l/min |
| Pump height max.                             | 1.1     | m     |
| Inlet valve                                  | 4       | l/min |
| Spray arm lower                              | ~ 33    | l/min |
| Sprayarm upper                               | ~ 27    | l/min |
| Shower top                                   | ~ 8     | l/min |
| Fan for drying:                              |         |       |
| Total  | 900     | l/min |
| Primary air flow                             | 210     | l/min |
| Secondary air flow                           | 780     | l/min |

### Electrical base data

|             |           |    |
|-------------|-----------|----|
| Voltage     | 220/ 230  | V  |
| Frequency   | 50        | Hz |
| Total power | 2.0 - 2.2 | kW |
| Fuse        | 10        | A  |

### Motor

#### Spray pump motor alternating spray system

|                   |          |     |
|-------------------|----------|-----|
| Voltage           | 220/ 240 | V   |
| Power consumption | 125      | W   |
| HI                | 79       | Ω   |
| HA                | 60       | Ω   |
| Capacitor         | 4        | μ F |

#### Drain pump motor

|                   |          |   |
|-------------------|----------|---|
| Voltage           | 220/ 240 | V |
| Power consumption | 30       | W |
| Resistance        | 146      | Ω |

#### Fan for drying

|            |           |   |
|------------|-----------|---|
| Voltage    | 220 - 240 | V |
| Resistance | 141       | Ω |

### Heating

#### 1 Element system

|                              |            |        |
|------------------------------|------------|--------|
| Voltage                      | 220/ 230   | V      |
| Power consumption            | 1.87/ 2.04 | kW     |
| Resistance                   | 24.5       | Ω      |
| Heating speed                | ~ 2.0      | °C/min |
| Temperature on surface       | ~ 115      | °C     |
| Safety thermostat self reset |            |        |
| (Temperature of water)       | ~ 85       | °C     |
| Fuse                         | 206        | °C     |

### Potentiometer

|                        |                         |
|------------------------|-------------------------|
| Points of measurement: | 1 (black) to 2 (middle) |
| Position 0             | 0.0 kΩ                  |
| Position 1             | 0.5 kΩ                  |
| Position 2             | 1.0 kΩ                  |
| Position 3             | 1.4 kΩ                  |
| Position 4             | 1.8 kΩ                  |
| Position 5             | 2.3 kΩ                  |
| Position 6             | 2.6 kΩ                  |

**Technical data**

**Single electric inlet valve**

|            |          |    |
|------------|----------|----|
| Voltage    | 220/ 240 | V  |
| Frequency  | 50/ 60   | Hz |
| Resistance | 3.76     | kΩ |

**Regenerating valve**

|            |          |    |
|------------|----------|----|
| Voltage    | 220/ 240 | V  |
| Frequency  | 50/ 60   | Hz |
| Resistance | 3.13     | kΩ |

**Motor Diverter Valve**

|                             |           |    |
|-----------------------------|-----------|----|
| Voltage                     | 220 - 240 | V  |
| Frequency                   | 50/ 60    | Hz |
| Resistance                  | 6.5       | kΩ |
| Signal (2x within ~13 sec.) | 5.0       | V  |

**Coil of dispenser**

|            |          |    |
|------------|----------|----|
| Voltage    | 220/ 240 | V  |
| Frequency  | 50/ 60   | Hz |
| Resistance | 1.3      | kΩ |

**Reed contacts**

flow meter  
 salt control  
 rinse aid control

**Optical water indicator (OWI)**

Optical measurement of the water in sump  
 Combination part of:  
 Turbidity sensor (DON)  
 Thermostat temp. sensor (notice NTC)

**NTC**

|       |      |    |
|-------|------|----|
| 20 °C | 58.1 | kΩ |
| 25 °C | 47.1 | kΩ |
| 30 °C | 38.2 | kΩ |
| 40 °C | 25.4 | kΩ |
| 50 °C | 17.2 | kΩ |
| 60 °C | 11.8 | kΩ |
| 70 °C | 8.3  | kΩ |
| 80 °C | 6    | kΩ |
| 85 °C | 4    | kΩ |

**Regeneration**

|                                      |            |                 |
|--------------------------------------|------------|-----------------|
| Volume                               | 300        | cm <sup>3</sup> |
| Position 0<br>after wash cycles      | 12         |                 |
| water hardness                       | 0 - 5      | °dh             |
|                                      | 0 - 0.9    | mmol/l          |
|                                      | 0 - 9      | °Fh             |
| Position 1<br>after wash cycles      | 10         |                 |
| water hardness                       | 6 - 10     | °dh             |
|                                      | 1 - 1.8    | mmol/l          |
|                                      | 10 - 18    | °Fh             |
| Position 2<br>after wash cycles      | 7          |                 |
| water hardness                       | 11 - 15    | °dh             |
|                                      | 1.9 - 2.7  | mmol/l          |
|                                      | 19 - 27    | °Fh             |
| Position 3<br>after wash cycles      | 5          |                 |
| water hardness                       | 16 - 21    | °dh             |
|                                      | 2.8 - 3.7  | mmol/l          |
|                                      | 28.37      | °Fh             |
| Position 4<br>after wash cycles      | 3          |                 |
| water hardness                       | 22 - 28    | °dh             |
|                                      | 3.8 - 5.0  | mmol/l          |
|                                      | 38 - 50    | °Fh             |
| Position 5<br>after wash cycles      | 2          |                 |
| water hardness                       | 29 - 35    | °dh             |
|                                      | 5.1 - 6.3  | mmol/l          |
|                                      | 51 - 63    | °Fh             |
| Position 6<br>after wash cycles      | 1          |                 |
| water hardness                       | 36 - 60    | °dh             |
|                                      | 6.4 - 10.7 | mmol/l          |
|                                      | 64 - 107   | °Fh             |
| Salt consumption<br>for regeneration | 77         | g               |
| Number of cycles<br>with 2 kg salt   | 26         |                 |

**Accessory**

If you need spare parts apart from the spare part list have a look in the Service Bulletin 4812 718 40084.

## Spare part list

Model **ADG 6966 IXM**  
Service No. **854296610750**  
Version **854296610750**

| Pos. No. | 12NC Code             | Description                  |
|----------|-----------------------|------------------------------|
| 003 0    | <b>4812 440 19594</b> | Traverse                     |
| 004 0    | <b>4812 440 18952</b> | Drip tray assy               |
| 004 1    | <b>4812 401 18402</b> | Holder                       |
| 011 0    | <b>4812 505 18369</b> | Foot long                    |
| 011 1    | <b>4812 528 98004</b> | Shaft flexible               |
| 011 2    | <b>4812 528 78032</b> | Slide disc f.foot            |
| 011 3    | <b>4812 535 98054</b> | Gear                         |
| 011 4    | <b>4812 528 98001</b> | Roll f.foot                  |
| 022 0    | <b>4812 440 19398</b> | Side panel left              |
| 022 1    | <b>4812 440 19397</b> | Side panel right             |
| 024 0    | <b>4812 440 10417</b> | Panel, rear                  |
| 040 1    | <b>4812 417 18774</b> | Hinge left                   |
| 040 2    | <b>4812 417 18773</b> | Hinge right                  |
| 044 0    | <b>4812 492 38362</b> | Spring f.door                |
| 047 0    | <b>4812 404 48746</b> | Brake f.door                 |
| 047 1    | <b>4812 401 18397</b> | Band,brake                   |
| 047 2    | <b>4812 404 68023</b> | Hook                         |
| 053 0    | <b>4819 440 19907</b> | Plinth service kit Thermodyr |
| 103 0    | <b>4812 440 19478</b> | Door outer                   |
| 105 0    | <b>4812 404 48611</b> | Fastener door                |
| 105 2    | <b>4812 505 68004</b> | Clip                         |
| 120 0    | <b>4812 440 19456</b> | Door,inner                   |
| 120 1    | <b>4812 440 18969</b> | Batten                       |
| 130 0    | <b>4812 417 58373</b> | Tilt lock cpl. bk            |
| 131 0    | <b>4812 401 18416</b> | Hook lock                    |
| 175 3    | <b>4812 466 68572</b> | Batten                       |
| 191 0    | <b>4812 466 68564</b> | Gasket door                  |
| 192 0    | <b>4812 466 68467</b> | Gasket, door lower           |
| 241 0    | <b>4812 458 19027</b> | Basket upper straight        |
| 241 1    | <b>4812 458 18324</b> | Holder cups right wh         |
| 241 3    | <b>4812 528 88068</b> | Wheel,basket upper (set)     |
| 241 4    | <b>4812 458 18984</b> | Holder dishes wh             |
| 241 5    | <b>4812 535 78043</b> | Bearing                      |
| 241 7    | <b>4812 404 48683</b> | Hoop                         |
| 241 8    | <b>4812 466 68553</b> | Spacer cap set               |
| 242 0    | <b>4812 310 28136</b> | Basket lower KIT             |
| 242 1    | <b>4812 528 88069</b> | Wheel,basket lower wh        |
| 242 4    | <b>4812 466 48059</b> | Fixation wh                  |
| 242 6    | <b>4812 458 18977</b> | Support plate left           |
| 242 7    | <b>4812 458 18978</b> | Support plate right          |
| 243 0    | <b>4812 458 18272</b> | Basket cutlery               |
| 243 5    | <b>4819 310 39859</b> | Cutlery basket KIT           |
| 243 6    | <b>4812 458 18996</b> | Grille wh                    |
| 261 0    | <b>4819 462 38271</b> | Rail telescope, inner        |
| 261 1    | <b>4812 462 79768</b> | Cap rail                     |
| 261 2    | <b>4812 462 78995</b> | Cap rail ahead               |
| 263 0    | <b>4819 520 18013</b> | Ball cage cpl.               |
| 263 1    | <b>4812 520 48001</b> | Ball Niro 8 D                |
| 265 0    | <b>4812 404 48637</b> | Basket adjustm. cpl.         |
| 265 2    | <b>4812 404 48638</b> | Grip basket adjustment       |
| 301 0    | <b>4812 453 71585</b> | Control panel INOX           |
| 303 1    | <b>4812 460 38089</b> | Plate,handle BK              |
| 305 1    | <b>4819 502 18241</b> | Screw synthetic              |
| 305 2    | <b>4819 505 18191</b> | Nut                          |
| 305 6    | <b>4812 440 19466</b> | Batten silv-met.             |

| Pos. No. | 12NC Code             | Description                   |
|----------|-----------------------|-------------------------------|
| 331 0    | <b>4812 413 59018</b> | Knob program cpl. BK          |
| 332 0    | <b>4812 410 28675</b> | Button BK                     |
| 332 2    | <b>4812 410 28672</b> | Button BK                     |
| 350 1    | <b>4812 440 19781</b> | Window BK                     |
| 350 2    | <b>4812 381 28047</b> | Lens                          |
| 400 0    | <b>4812 361 58336</b> | Motor +SP,50Hz,alt.LP-PNT1    |
| 405 0    | <b>4812 360 18509</b> | Spray pump wo.Mot.alt.LP-50Hz |
| 405 1    | <b>4819 515 28158</b> | Gasket                        |
| 420 0    | <b>4812 121 18132</b> | Capacitor                     |
| 421 0    | <b>4812 121 18158</b> | Interf.filter                 |
| 430 0    | <b>4812 360 18508</b> | Pump,draining                 |
| 430 1    | <b>4812 466 68689</b> | Gasket                        |
| 442 0    | <b>4812 361 18196</b> | Blower cpl.                   |
| 450 0    | <b>4812 259 28684</b> | Heating element               |
| 480 0    | <b>4812 321 28405</b> | Cable harness set             |
| 480 3    | <b>4812 401 18418</b> | Protector f.wiring            |
| 490 0    | <b>4819 321 18136</b> | Cable,mains 2m SA             |
| 490 1    | <b>4812 321 28367</b> | Strain relief                 |
| 521 0    | <b>4812 214 78822</b> | Control board (CB)            |
| 531 0    | <b>4812 273 18055</b> | Switch waterhardness          |
| 531 1    | <b>4812 273 18056</b> | Wheel,fingertip               |
| 575 0    | <b>4812 281 28361</b> | Regen.valve                   |
| 583 0    | <b>4812 271 28459</b> | Switch diaphragm (OWI)        |
| 616 0    | <b>4812 281 18047</b> | Contact,reed salt             |
| 616 1    | <b>4812 271 58161</b> | Contact,reed rinsing agent    |
| 620 0    | <b>4812 310 28066</b> | User board KIT (DUB)          |
| 623 0    | <b>4812 271 38356</b> | Microswitch                   |
| 633 0    | <b>4812 271 38355</b> | Microswitch door              |
| 680 0    | <b>4812 418 68155</b> | Combidosage                   |
| 680 1    | <b>4812 466 68495</b> | Gasket                        |
| 681 1    | <b>4812 466 68497</b> | Gasket                        |
| 681 2    | <b>4812 440 18975</b> | Flap                          |
| 682 0    | <b>4812 466 68496</b> | Gasket                        |
| 691 1    | <b>4812 462 79769</b> | Stopper NTC                   |
| 700 0    | <b>4812 530 28804</b> | Hose, inlet aqua stop 4,2m    |
| 700 0    | <b>4812 530 28848</b> | Hose, inlet aqua stop 2m      |
| 700 1    | <b>4812 480 48095</b> | Sieve                         |
| 700 2    | <b>4812 466 68628</b> | Gasket                        |
| 701 1    | <b>4812 310 18153</b> | Yoke clamp set                |
| 710 0    | <b>4812 418 68128</b> | Monoblock                     |
| 710 2    | <b>4819 310 38536</b> | Threaded ring                 |
| 710 3    | <b>4819 466 69562</b> | Gasket set                    |
| 714 0    | <b>4812 462 78993</b> | Threaded cap                  |
| 716 0    | <b>4812 418 68147</b> | Reg.dosage                    |
| 716 1    | <b>4812 466 68475</b> | Gasket                        |
| 716 2    | <b>4812 462 78994</b> | Cover                         |
| 717 0    | <b>4812 281 28418</b> | Valve motodiverter            |
| 717 2    | <b>4812 528 98011</b> | Valve disk diverter           |
| 717 3    | <b>4812 530 29121</b> | Gasket diverter valve         |
| 721 1    | <b>4812 360 68347</b> | Spray arm lower. cpl.         |
| 722 0    | <b>4812 360 68348</b> | Spray arm upper wh            |
| 722 2    | <b>4812 360 68349</b> | Spray arm 2nd level cpl. wh   |
| 723 0    | <b>4812 360 68351</b> | Douche ceiling                |
| 726 1    | <b>4812 530 29118</b> | Tube assembly cpl.            |
| 726 2    | <b>4812 505 18208</b> | Nut                           |

## Spare part list

**Model** ADG 6966 IXM  
**Service No.** 854296610750  
**Version** 854296610750

| Pos. No. | 12NC Code             | Description                 |
|----------|-----------------------|-----------------------------|
| 743 0    | <b>4812 530 48134</b> | Air guide                   |
| 743 1    | <b>4812 530 28102</b> | Hose, inlet                 |
| 743 2    | <b>4812 440 19334</b> | Air guide lower             |
| 743 3    | <b>4812 505 18364</b> | Nut                         |
| 743 4    | <b>4812 281 38001</b> | Valve disk                  |
| 743 5    | <b>4812 466 98934</b> | Disc                        |
| 743 6    | <b>4812 440 19688</b> | Grille SILVER               |
| 743 7    | <b>4812 466 68514</b> | Gasket                      |
| 743 8    | <b>4812 440 19372</b> | Swell pipe                  |
| 751 0    | <b>4812 418 18338</b> | Water collector             |
| 755 0    | <b>4812 530 29119</b> | Bend                        |
| 755 2    | <b>4812 530 48148</b> | Tray,leak                   |
| 756 0    | <b>4812 360 58099</b> | Floater                     |
| 761 0    | <b>4812 480 58122</b> | Sieve fine                  |
| 761 2    | <b>4812 418 18337</b> | Cover sieve                 |
| 761 3    | <b>4812 418 18341</b> | Cover                       |
| 761 4    | <b>4812 530 58141</b> | O-Ring                      |
| 763 0    | <b>4812 480 58123</b> | Sieve coarse                |
| 781 0    | <b>4812 530 29113</b> | Hose,draining               |
| 781 3    | <b>4812 281 28417</b> | Flap non-return             |
| 783 6    | <b>4812 530 28796</b> | Hose 10x3x180+10            |
| 791 0    | <b>4812 532 68099</b> | Gasket                      |
| 791 2    | <b>4812 530 58093</b> | Gasket                      |
| 900 1    | <b>4812 310 28021</b> | Fastener set (not shown)    |
| 901 0    | <b>4822 401 10258</b> | Clamp,hose 10-18 mm         |
| 901 1    | <b>4812 401 18424</b> | Strap 050,0                 |
| 901 2    | <b>4812 401 18157</b> | Strap 32-50/9 C61           |
| 901 5    | <b>4812 401 48573</b> | Strap 028,6                 |
| 901 8    | <b>4812 401 18075</b> | Strap 20-32/9 mm            |
| 902 1    | <b>4812 466 78015</b> | Fastener f.buildt-in models |
| 902 2    | <b>4812 404 78241</b> | Holder                      |
| 904 2    | <b>4812 462 79657</b> | Cover BK 3,5x5              |
| 910 1    | <b>4812 502 38152</b> | Screw 4,8x19                |
| 910 2    | <b>4812 502 18363</b> | Screw 4,0x12-H              |
| 910 3    | <b>4812 502 18389</b> | Screw 5x20 T20              |
| 910 4    | <b>4812 502 18385</b> | Screw M3,5x8-T15M           |
| 910 5    | <b>4812 502 18393</b> | Screw 3,5x9-1 Tx15          |
| 910 7    | <b>4812 502 18397</b> | Screw INOX A2 M 5X12        |
| 910 8    | <b>4812 502 18527</b> | Screw 4x15 T20              |
| 910 9    | <b>4812 401 18425</b> | Screw 2,5x18-H              |
| 964 1    | <b>4812 466 68573</b> | Gasket housing upper        |
| 993 1    | <b>4812 466 78388</b> | Foil protection             |
| 993 2    | <b>4812 404 48753</b> | Key foot                    |
| 993 5    | <b>4822 532 80216</b> | Funnel salt                 |

## Exploded view

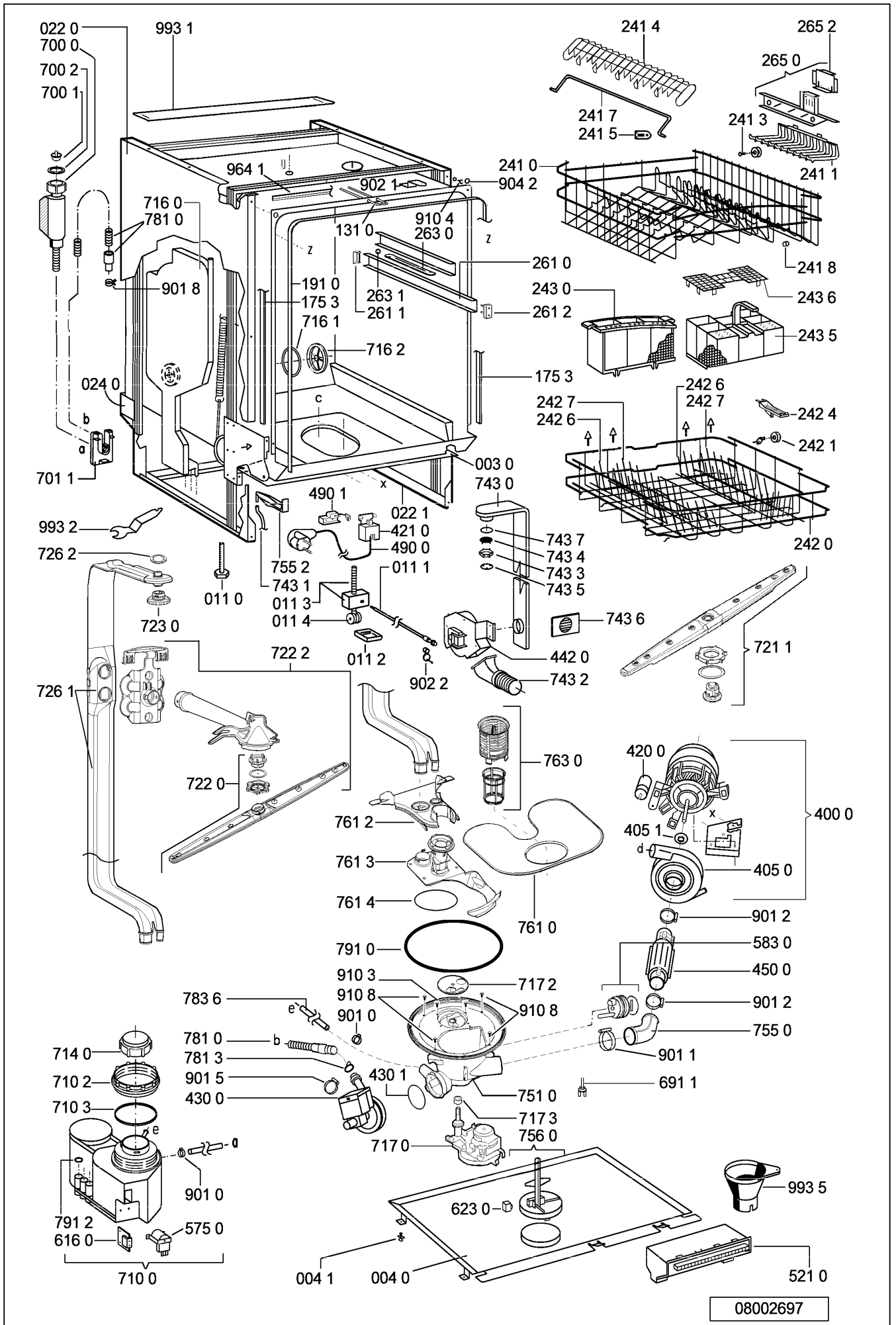

08002697

### Exploded view

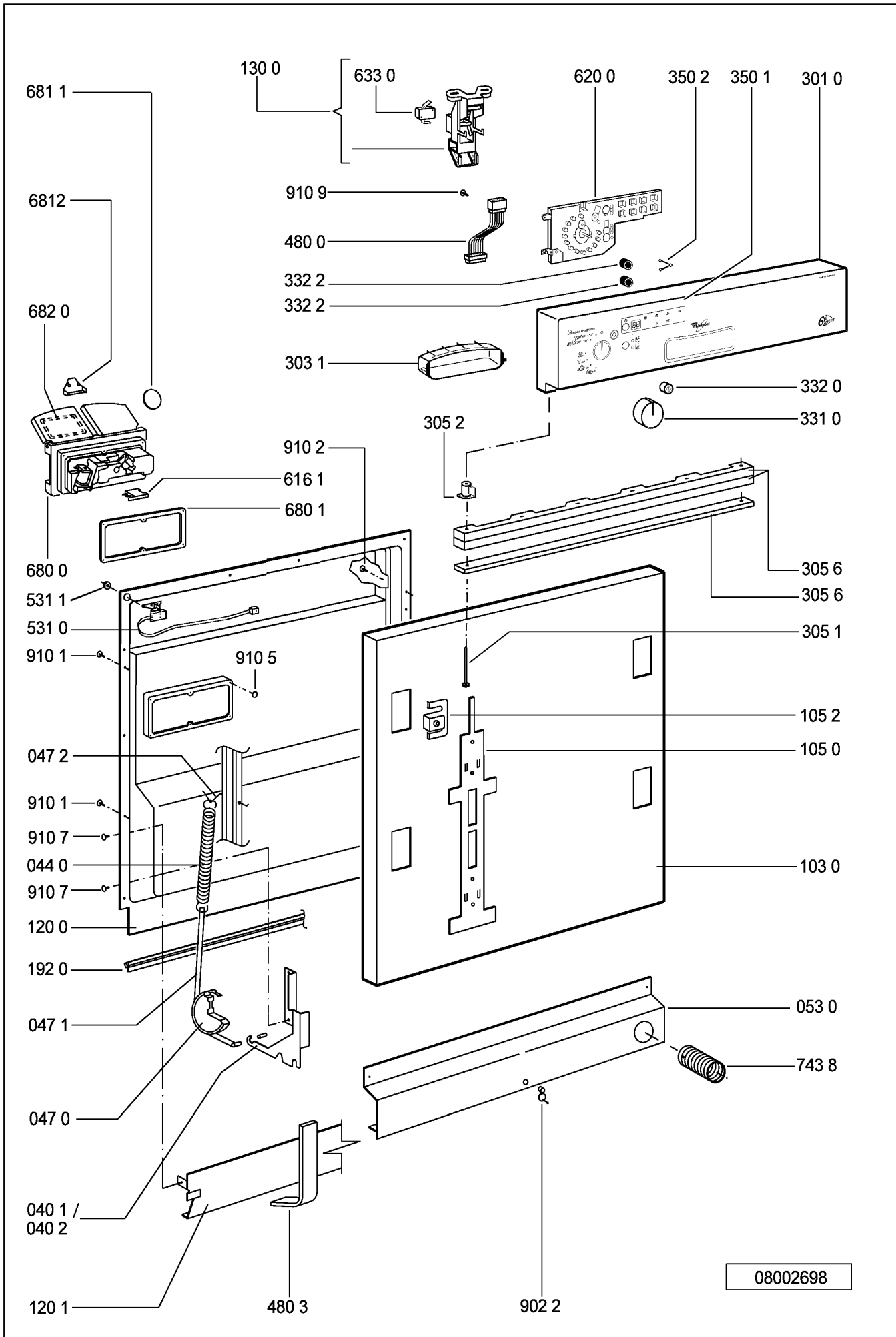

08002698



## Circuit diagram

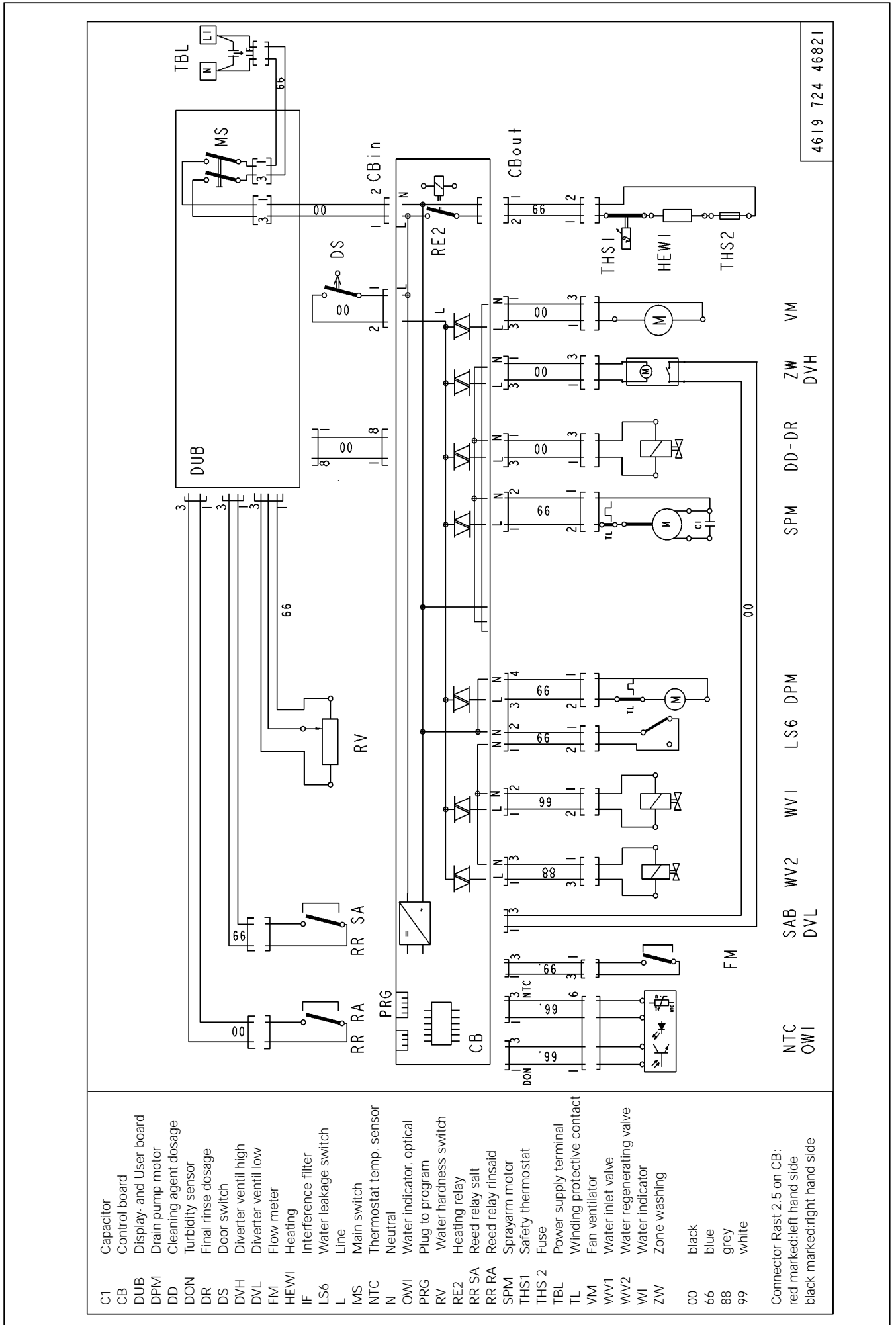



## Text/Legend

### **Test procedure for SERVICE-TEST-PROGRAM Point dishwashers appliances with and without 7 Segment Display**

Switch on the appliance. If there is no failure indicated, then:

1. Start the passive test program.  
If there is a defective component indicated, open the plinth and take out the control board (CB).
2. Check the component.  
Unplug the indicated component from the control board (CB) and check it by using an Ohmmeter  
If the resistance is not correct, check the cables to the component and check the component itself.
3. Visibly check the control board (CB).
4. At the end of the repair start the appliance and delete the failure. After this, start the passive and active test program again to see that the failure is solved.

More details: see following pages.

#### **Attention:**

**Danger** for short circuit. Short circuits on components can damage the control board (CB).

If electronic boards are wet, do not switch the appliance on.

To check the appliance, plug in the appliance.

Failures, which occurred during the program will be stored and indicated by flashing the start LED.

The failure will be indicated and can be related to the failure table.

To erase the failures, you must push the start button longer than 1,5 seconds.

The failures

- F1 NTC break

- F2 water leakage

- F9 continuous water inlet

are checked and indicated immediately after start of the program.

Therefore these failures have to be solved before starting the active test program.

When these failures are not solved, the active test program does not run.

The electrical components get their voltage via triac from the control board (CB). To test the voltage the voltmeter must be connected in parallel to the component (the component must be connected). If the component is disconnected, then the output voltage from the control board (CB) is reduced.

**After starting a program this program is locked. That means neither by unplugging/switching off the appliance nor by setting to another program, the first set program cannot be changed. Changing of the program is only possible by pushing the start button again for longer than 1,5 sec..**

**Attention:** New service control boards start at first with the service test program. This test program is without back rinsing. **Dangerous for overfilling the appliance, in case the appliance is not empty.** By running the test program or another program a second time, the back rinsing will be carried out as usual.

4619 724 43901-1

## Text/Legend

### **Handling of failures**

- F0 Sensor failure (only when a dirt sensor is installed )  
Will not be indicate to the customer. The programs will finish even if there is a failure. The Failure is indicated only in the active test program after 10 – 30 second's. The active test program will finish as well, even if there is a failure.  
If the failure in a sensor program appears, the machine will always choose the highest consumption (best cleaning result).  
- None or wrong output from the sensor  
- Unlogical or unreal measurement results  
Reason:  
- Defective electronic of the sensor  
- Optoelectronic parts in the sensor defect  
- The sensor is very dirty  
- Connection between sensor and control board (CB) interrupted  
Attention: The failure code will not store.
- F1. NTC break  
Temperature out of the normal value (-3°C till +85°C)  
- Temperature inside higher than +85°C  
- NTC defective  
- Dishwasher is frozen, less than -3°C  
If the temperature is less than -3°C, fill the appliance with a cup of warm water to warm it up before you start it..
- F2. Water Leakage  
- Water is in the drip tray  
Floater (LS6) switches off the WV1 and the electronic switches on the DPM until WI reports that it is empty.
- F3. Heating System Defective  
Indicated after app. 25 minutes (1. check after 5 min., after that follow 2 more checks, before the failure is indicate)  
- Heats too slowly (less than 1,5 °C in 10 min.)  
- Heating (HEW) defective  
- Relays (RE2) on control board (CB) is defective  
- NTC - resistance fluctuation
- F4. Draining Failure  
Drain pump starts and after 4 min. the WI detects that it is "not empty"  
- Drain pump (DPM) defective  
- Siphon closed  
- Control board (CB) defective  
- OWI/WI defective.

## Text/Legend

- F6. Water Tap Closed  
Water valve (WV1) is switched on but flow meter (FM) sends no impulses (less than 10 imp. in 10 sec.) and the water indicator (WI) is off (empty)
- Water tap closed
  - Water inlet hose blocked
  - Water inlet valve (WV1) defective
  - Flow meter (FM) defective (leads to FM failure)
- F7. Flow Meter Failure  
Water inlet valve (WV1) is switched on and the water indicator (WI) is on (full).
- Flow meter (FM) sends too few impulses (less than 10 imp. in 10 sec.)
  - Water tap closed during water inlet
  - Water inlet hose blocked
  - Water inlet valve (WV1) defective
  - Flow meter (FM) defective
- F8. Water Level Failure.  
Failures are supervised over the whole program.  
*Mechanical water indicator WI:* Spray pump works, the WI switches more than 20 times in 2 minutes back.  
*Optical water indicator OWI:* Always after the OWI-Signal is missing, the electrical components are turned off for 5 sec. If after the 5 sec. the OWI-Signal is still not present then, it notes a Failure F8. If, however, after the 5 sec. the OWI-Signal is present, then the water-level is filled to 6 Ltr. and the electrical components are again turned on. After the OWI signal is missing for a second time note an F8 Failure.
- WI defect? Should switch on after approx. 1 Ltr
  - Sieve blocked
  - Water strongly foams
  - Pot has turned off and is filled with spray water
  - No stable spray pump (SPM) working
- F9. Continuous Water Inlet  
Water inlet valve (WV1) is switched off, water indicator (WI) on, flow meter (FM) sends impulses (more than 10 imp. in 10 sec.)
- Water inlet valve (WV1) mechanically not closed
  - Triac (CB) permanently switched on. (short circuit)
- Reaction: interval 30 sec. drain pump on / 20 sec. drain pump off in interval

**The following failures will only be indicated, when the relevant component is installed.**

## Text/Legend

### FA. OWI (Optical Water Indicator) – Failure

If the electronics signals of the Flow meter for the 3,4 Ltr. of water has been received on permanent wash system and 2,5 Ltr on alternating wash system and the OWI signal "Water in the sump" is missing then take note.

- Lens will be cleaned: Water inlet off for 10 Sec and SPM on for 10 Sec.

- If after that there is still no signal "Water in sump", then the appliance goes into failure mode FA.

### FB. MDV (Motor Diverter) – Failure

Failure condition:

Start water inlet. After 15 sec. switches the WI. After that, when not within 120 sec. comes a signal from the MDV to the control board, lower or upper spray arm is functioning, then the FB will indicate.

Check:

- Do the upper and lower spray arms alternate turns in approx. 30-40 sec.? If only one turns then there is a failure.

- Is the diverter disc in the sump blocked? Yes, unblock it.

- Does 230V come from the control board (ZW,DVH) to the MDV? No, change control board.

How to check:

Start test program and wait until backrinse is over. After the start of the regular water-inlet must come 230V within 30 sec. for approx. 20 sec. to the MDV.

- Is the winding of the MDV or cable to the MDV interrupted? (ZW,DVH) resistance of the MDV should be approx. 6,3 K $\Omega$

- Is the signal cable between the MDV and control board (SAB,DVL) carrying 5v?

### FC. ASA ( Automatic Salt Adaptation )/ Water hardness sensor Failure (only indicates in the active test program)

Failure condition:

Electronic on the water softener detects high electrical resistance in the resin.

Check:











Cables on the sensors of the water softener interrupted or weak contact? Cables from the control board (ASA) to WHS electronic on the water softener interrupted or weak contact?

For salt, rinse aid, zone wash valve, sieve valve failure see active test program.

## Text/Legend

### Failure Display POINT

#### Appliances with 1 and 2-digit 7 Segment Display and without 7 Segment Display

| Alarm / Failure  | Failure code, Indication in test program when a failure occurs  |                                      |
|--|---|--------------------------------------|
|  | Shown with 7 segment display or without 7 segment display   | Shown on 2/3 digit 7 segment display |
| <b>F1 NTC-Failure</b>  | START<br><br>1 x flash 1s Pause 1 x flash.....         | <b>F1</b>                            |
| <b>F2 Water Leakage</b>  | START<br><br>2 x flashes 1s Pause 2 x flashes.....     | <b>F2</b>                            |
| <b>F3 Failure in Heating System</b>                                | START<br><br>3 x flashes 1s Pause 3 x flashes.....     | <b>F3</b>                            |
| <b>F4 Draining Failure</b>   | START<br><br>4 x flashes 1s Pause 4 x flashes.....     | <b>F4</b>                            |
| <b>F6 Water Tap closed</b>   | START<br><br>6 x flashes 1s Pause 6 x flashes.....   | <b>F6</b>                            |
| <b>F7 Flow Meter Failure</b>                                       | START<br><br>7 x flashes 1s Pause 7 x flashes.....   | <b>F7</b>                            |
| <b>F8 Water Level Failure</b>                                      | START<br><br>8 x flashes 1s Pause 8 x flashes.....   | <b>F8</b>                            |
| <b>F9 Continuous Waterinlet</b>                                    | START<br><br>9 x flashes 1s Pause 9 x flashes.....   | <b>F9</b>                            |
| <b>F0 Sensor-Failure<br/>(Only displayed in act. test program)</b> | START<br><br>10 x flashes 1s Pause 10 x flashes..... | <b>F0</b>                            |
| <b>FA OWI-Fehler</b>   | START<br><br>11 x flashes 1s Pause 11 x flashes..... | <b>FA</b>                            |
| <b>FB MDV-Fehler</b>   | START<br><br>12 x flashes 1s Pause 12 x flashes..... | <b>FB</b>                            |
| <b>FC ASA-Fehler<br/>(Only displayed in act. test program)</b>     | START<br><br>13 x flashes 1s Pause 13 x flashes..... | <b>FC</b>                            |

 LED flashing

- "Rotor blocked (F5)" isn't displayed on the POINT appliance

## Text/Legend

With the passive test program, you can check all LED's and buttons. If there is no failure the passive test program runs normally.

**Attention:**

If you can't start the active test program (Start button doesn't flash), normally there is one of the following failures detected: F1, F2 or F9

When these failures are not solved before, the passive and active test program will not run. After solving the failure you must "sign" (erase) the failure.

A present failure will be indicate directly after you switch on the appliance. Then fix the mistake, erase failure and start test program again (see following start procedure).

### Start procedure

#### Start the passive test program if there is no failure indicated

If there is no failure the passive test program runs normally.

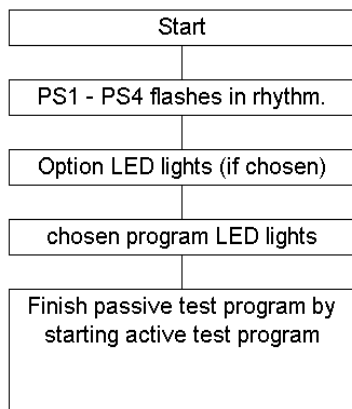

1. Turn OFF appliance
2. Push start button and hold it.
3. Select program position 1.( turn to the right or with WP VBL turn to the left)
4. Finish pushing the start button when the start LED flashes.
5. Test all LEDs by operating the buttons and the program knob. After the check, turn the program knob on to program place 1
6. Start the active test program by pushing the start button again
7. Failure indication.
8. Repair the failure
9. Solve the failure by pushing the start button for longer than 1,5 sec.
10. Start the active test program again, to see, if the failure is really solved

**Active test program starts (see next page)**

|     |       |                       |                                  |  |
|-----|-------|-----------------------|----------------------------------|--|
| PS1 | 1.LED | prewash               |                                  |  |
| PS2 | 2.LED | mainwash              |                                  |  |
|     |       | intermediate rinse    |                                  |  |
|     |       | final rinse           |                                  |  |
| PS3 | 3.LED | drying (regeneration) |                                  |  |
| PS4 | 4.LED | end                   | goes off if any button is pushed | goes off if after 30 min prog. Is finished |



## Text/Legend

### Active test program

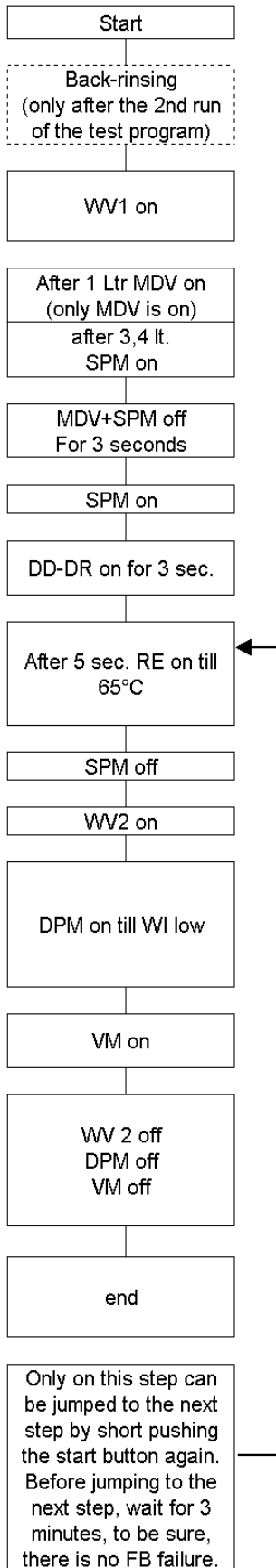

### Remarks

The active test program runs to the failure position and stops or, if there is no failure, it runs to the end.

To leave the test program push the start button for longer than 1,5 second's.

Not enough salt or rinse aid will not stop the running of the appliance.

**Remark** When switching off the main switch or interrupting the mains, during the test program runs, then the alternating of the spray arms changes in the test program from 30/30 sec. to the rhythm of the main wash 5/3 min.

**Important** Leaving the test program is possible by making a break by the customer (Pushing the start button for more than 1,5 sec.).

After finishing the test program (End LED shines and/or Start LED goes off) then the appliance must be switched off.

If this is not done, then the next main wash will be made with the frequency of the Service Test Program ~30/30 sec. instead of 3/5 min.

When the failure position is reached the failure indication is indicated on the page "Failure Codes"

### **Attention:**

If you can't start the active test program (Start button doesn't flash), normally there is one of the following failures detected: F1, F2 or F9

When these failures are not repaired before, the active test program will not run. After solving the failure you must "sign" (erase) the failure.