

Service Manual

Plasma Television

Model No. **TX-P42UT30B**

TX-P42UT30Y

GPF14D-E Chassis

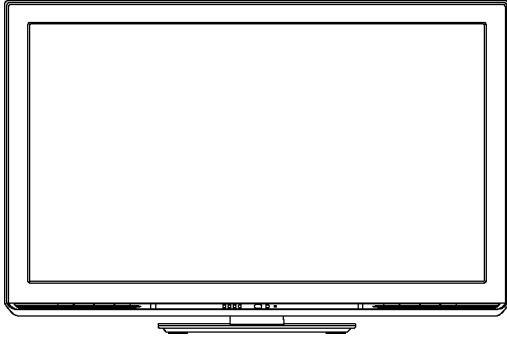

WARNING

This service information is designed for experienced repair technicians only and is not designed for use by the general public. It does not contain warnings or cautions to advise non-technical individuals of potential dangers in attempting to service a product. Products powered by electricity should be serviced or repaired only by experienced professional technicians. Any attempt to service or repair the product or products dealt with in this service information by anyone else could result in serious injury or death.

IMPORTANT SAFETY NOTICE

There are special components used in this equipment which are important for safety. These parts are marked by  in the Schematic Diagrams, Circuit Board Diagrams, Exploded Views and Replacement Parts List. It is essential that these critical parts should be replaced with manufacturer's specified parts to prevent shock, fire or other hazards. Do not modify the original design without permission of manufacturer.

Panasonic[®]

© Panasonic Corporation 2011.
Unauthorized copying and distribution is a violation
of law.

TABLE OF CONTENTS

	PAGE		PAGE
1 Safety Precautions	3	11.1. Caution statement.	41
1.1. General Guidelines	3	11.2. Wiring (1)	41
1.2. Touch-Current Check	3	11.3. Wiring (2)	42
2 Warning	4	11.4. Wiring (3)	42
2.1. Prevention of Electrostatic Discharge (ESD) to Electrostatically Sensitive (ES) Devices	4	11.5. Wiring (4)	43
2.2. About lead free solder (PbF)	5	11.6. Wiring (5)	43
3 Service Navigation	6	12 Schematic Diagram	
3.1. PCB Layout	6	13 Printed Circuit Board	
3.2. Applicable signals	7	14 Exploded View	
4 Specifications	8		
5 Technical Descriptions	10		
5.1. Specification of KEY for CI Plus, DTCP-IP, WIDEVINE and One-to-One	10		
6 Service Mode	11		
6.1. How to enter into Service Mode	11		
6.2. Option - Mirror	13		
6.3. Service tool mode	13		
6.4. Hotel mode	14		
6.5. Data Copy by SD Card	15		
7 Troubleshooting Guide	18		
7.1. Check of the IIC bus lines	18		
7.2. Power LED Blinking timing chart	19		
7.3. No Power	19		
7.4. No Picture	20		
7.5. Local screen failure	21		
8 Disassembly and Assembly Instructions	22		
8.1. Remove the Rear cover	22		
8.2. Remove the AC inlet	22		
8.3. Remove the P-Board	22		
8.4. Remove the Side terminal cover	22		
8.5. Remove the Tuner unit	22		
8.6. Remove the A-Board	23		
8.7. Remove the Speakers	23		
8.8. Remove the SN-Board	23		
8.9. Remove the SS-Board	23		
8.10. Remove the Stand bracket and the Hanger metals	24		
8.11. Remove the Plasma panel section from the Cabinet assy	24		
8.12. Remove the Radiator plate	24		
8.13. Remove the C1-Board	25		
8.14. Remove the C2-Board	25		
8.15. Remove the Attachment metal bottom	25		
8.16. Remove the Attachment metal top	25		
8.17. Remove the Glass holders	25		
8.18. Remove the K-Board	26		
8.19. Remove the V-Board	26		
8.20. Replace the Plasma panel	26		
9 Measurements and Adjustments	27		
9.1. Adjustment	27		
10 Block Diagram	35		
10.1. Main Block Diagram	35		
10.2. Block (1/4) Diagram	36		
10.3. Block (2/4) Diagram	37		
10.4. Block (3/4) Diagram	38		
10.5. Block (4/4) Diagram	39		
11 Wiring Connection Diagram	41		

1 Safety Precautions

1.1. General Guidelines

1. When conducting repairs and servicing, do not attempt to modify the equipment, its parts or its materials.
2. When wiring units (with cables, flexible cables or lead wires) are supplied as repair parts and only one wire or some of the wires have been broken or disconnected, do not attempt to repair or re-wire the units. Replace the entire wiring unit instead.
3. When conducting repairs and servicing, do not twist the Fasten connectors but plug them straight in or unplug them straight out.
4. When servicing, observe the original lead dress. If a short circuit is found, replace all parts which have been overheated or damaged by the short circuit.
5. After servicing, see to it that all the protective devices such as insulation barriers, insulation papers shields are properly installed.
6. After servicing, make the following leakage current checks to prevent the customer from being exposed to shock hazards.

1.2. Touch-Current Check

1. Plug the AC cord directly into the AC outlet. Do not use an isolation transformer for this check.
2. Connect a measuring network for touch currents between each exposed metallic part on the set and a good earth ground such as a water pipe, as shown in Figure 1.
3. Use Leakage Current Tester (Simpson 228 or equivalent) to measure the potential across the measuring network.
4. Check each exposed metallic part, and measure the voltage at each point.
5. Reserve the AC plug in the AC outlet and repeat each of the above measure.
6. The potential at any point (TOUCH CURRENT) expressed as voltage U_1 and U_2 , does not exceed the following values:

For a. c.: $U_1 = 35 \text{ V (peak)}$ and $U_2 = 0.35 \text{ V (peak)}$;

For d. c.: $U_1 = 1.0 \text{ V}$,

Note:

The limit value of $U_2 = 0.35 \text{ V (peak)}$ for a. c. and $U_1 = 1.0 \text{ V}$ for d. c. correspond to the values 0.7 mA (peak) a. c. and 2.0 mA d. c.

The limit value $U_1 = 35 \text{ V (peak)}$ for a. c. correspond to the value 70 mA (peak) a. c. for frequencies greater than 100 kHz .

7. In case a measurement is out of the limits specified, there is a possibility of a shock hazard, and the equipment should be repaired and rechecked before it is returned to the customer.

Measuring network for TOUCH CURRENTS

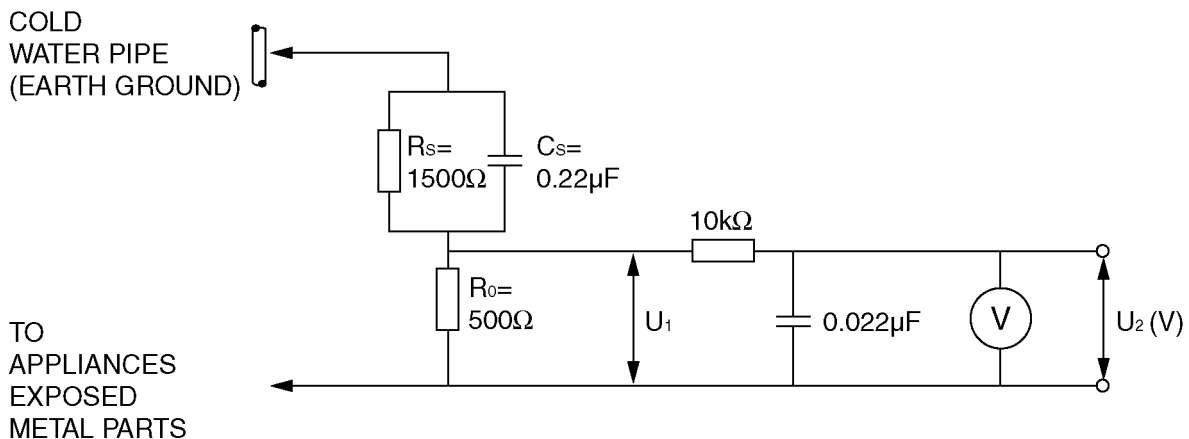

Resistance values in ohms (Ω)

V: Voltmeter or oscilloscope
(r.m.s. or peak reading)

Input resistance: $\geq 1 \text{ M}\Omega$

Input capacitance: $\leq 200 \text{ pF}$

Frequency range: 15 Hz to 1 MHz and d.c. respectively

NOTE - Appropriate measures should be taken to obtain the correct value in case of non-sinusoidal waveforms.

Figure 1

2 Warning

2.1. Prevention of Electrostatic Discharge (ESD) to Electrostatically Sensitive (ES) Devices

Some semiconductor (solid state) devices can be damaged easily by static electricity. Such components commonly are called Electrostatically Sensitive (ES) Devices. Examples of typical ES devices are integrated circuits and some field-effect transistors and semiconductor [chip] components. The following techniques should be used to help reduce the incidence of component damage caused by electrostatic discharge (ESD).

1. Immediately before handling any semiconductor component or semiconductor-equipped assembly, drain off any ESD on your body by touching a known earth ground. Alternatively, obtain and wear a commercially available discharging ESD wrist strap, which should be removed for potential shock reasons prior to applying power to the unit under test.
2. After removing an electrical assembly equipped with ES devices, place the assembly on a conductive surface such as aluminum foil, to prevent electrostatic charge buildup or exposure of the assembly.
3. Use only a grounded-tip soldering iron to solder or unsolder ES devices.
4. Use only an anti-static solder removal device. Some solder removal devices not classified as [anti-static (ESD protected)] can generate electrical charge sufficient to damage ES devices.
5. Do not use freon-propelled chemicals. These can generate electrical charges sufficient to damage ES devices.
6. Do not remove a replacement ES device from its protective package until immediately before you are ready to install it. (Most replacement ES devices are packaged with leads electrically shorted together by conductive foam, aluminum foil or comparable conductive material).
7. Immediately before removing the protective material from the leads of a replacement ES device, touch the protective material to the chassis or circuit assembly into which the device will be installed.

Caution

Be sure no power is applied to the chassis or circuit, and observe all other safety precautions.

8. Minimize bodily motions when handling unpackaged replacement ES devices. (Otherwise ham less motion such as the brushing together of your clothes fabric or the lifting of your foot from a carpeted floor can generate static electricity (ESD) sufficient to damage an ES device).

2.2. About lead free solder (PbF)

Note: Lead is listed as (Pb) in the periodic table of elements.

In the information below, Pb will refer to Lead solder, and PbF will refer to Lead Free Solder.

The Lead Free Solder used in our manufacturing process and discussed below is (Sn+Ag+Cu).

That is Tin (Sn), Silver (Ag) and Copper (Cu) although other types are available.

This model uses Pb Free solder in it's manufacture due to environmental conservation issues. For service and repair work, we'd suggest the use of Pb free solder as well, although Pb solder may be used.

PCBs manufactured using lead free solder will have the PbF within a leaf Symbol **PbF** stamped on the back of PCB.

Caution

- Pb free solder has a higher melting point than standard solder. Typically the melting point is 50 ~ 70 °F (30~40 °C) higher. Please use a high temperature soldering iron and set it to 700 ± 20 °F (370 ± 10 °C).
- Pb free solder will tend to splash when heated too high (about 1100 °F or 600 °C).
If you must use Pb solder, please completely remove all of the Pb free solder on the pins or solder area before applying Pb solder. If this is not practical, be sure to heat the Pb free solder until it melts, before applying Pb solder.
- After applying PbF solder to double layered boards, please check the component side for excess solder which may flow onto the opposite side. (see figure below)

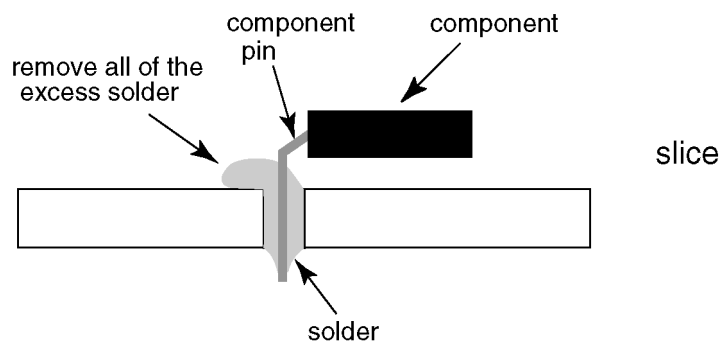

Suggested Pb free solder

There are several kinds of Pb free solder available for purchase. This product uses Sn+Ag+Cu (tin, silver, copper) solder. However, Sn+Cu (tin, copper), Sn+Zn+Bi (tin, zinc, bismuth) solder can also be used.

0.3mm X 100g	0.6mm X 100g	1.0mm X 100g

3 Service Navigation

3.1. PCB Layout

Remove the Rear cover

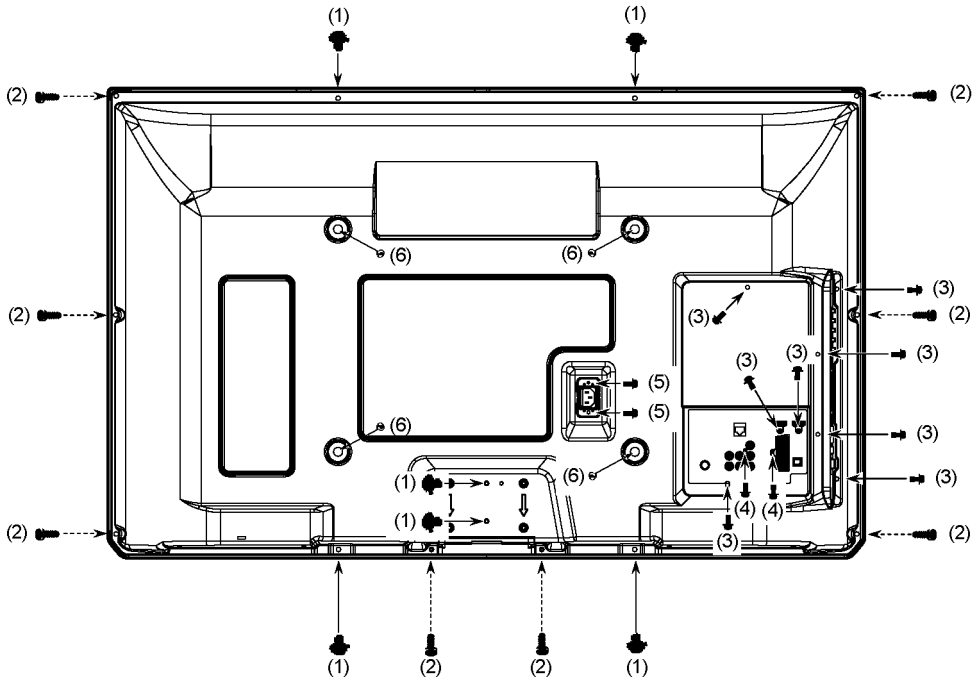

- Remove:
- 6screws (1) THEL052Z
 - 8screws (2) XTB4+12GFJK
 - 8screws (3) THEJ0409
 - 2screws (4) XTV3+10JFJK
 - 2screws (5) XYN3+F10FJK
 - 4screws (6) TKKL5493

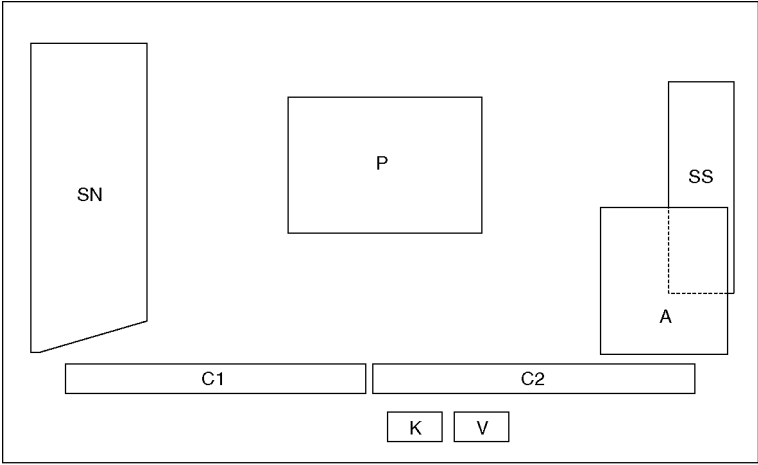

Board Name	Function	Board Name	Function
P	Power Supply	C1	Data Driver (Lower Right)
	Non serviceable P-Board should be exchange for service	C2	Data Driver (Lower Left)
A	Main AV input, processing	SN	Scan Drive
K	Remote receiver, Power LED, C.A.T.S. sensor	SS	Sustain Drive
V	3D Eyewear transmitter		

3.2. Applicable signals

COMPONENT (Y, P_B, P_R), HDMI

* Mark: Applicable input signal

Signal name	COMPONENT	HDMI
525 (480) / 60i, 60p	*	*
625 (576) / 50i, 50p	*	*
750 (720) / 60p, 50p	*	*
1,125 (1,080) / 60i, 50i	*	*
1,125 (1,080) / 60p, 50p, 24p		*

PC (from HDMI terminal)

Applicable input signal for PC is basically compatible to HDMI standard timing.

Signal name	Horizontal frequency (kHz)	Vertical frequency (Hz)
640 × 480 @60 Hz	31.47	60.00
1,280 × 720 @60 Hz	45.00	60.00
1,920 × 1,080 @60 Hz	67.50	60.00

Note

- Signals other than above may not be displayed properly.
- The above signals are reformatted for optimal viewing on your display.
- PC signal is magnified or compressed for display, so that it may not be possible to show fine detail with sufficient clarity.

4 Specifications

Power Source	AC 220-240 V, 50 / 60 Hz	
Rated Power Consumption	270 W	
On mode Average Power Consumption (Y)	121 W (based on IEC 62087 Ed.2 measurement method)	
Standby Power Consumption	0.40 W 16.00 W (With monitor out recording)	
Display panel		
Aspect Ratio	16:9	
Visible screen size	106 cm (diagonal) 921 mm (W) × 518 mm (H)	
Number of pixels	2,073,600 (1,920 (W) × 1,080 (H)) [5,760 × 1,080 dots]	
Sound		
Speaker	(160 mm × 40 mm) × 2, 6 Ω	
Audio Output	20 W (10 W + 10 W)	
Headphones	M3 (3.5 mm) stereo mini Jack × 1	
Receiving Systems / Band name (UK)	DVB-T / T2	Digital terrestrial services.
	PAL I	UHF E21-68
	PAL 525/60	Playback of NTSC tape from some PAL Video recorders (VCR) or NTSC disc playback from DVD player and recorder.
	M.NTSC	Playback from M.NTSC Video recorders (VCR).
	NTSC (AV input only)	Playback from NTSC Video recorders (VCR).
Receiving Systems / Band name (Ireland)	DVB-T	Digital terrestrial services.
	PAL I	VHF A - J UHF E21-69 CATV S1 - S20 CATV S21 - S41 (Hyperband)
	PAL 525/60	Playback of NTSC tape from some PAL Video recorders (VCR) or NTSC disc playback from DVD player and recorder.
	M.NTSC	Playback from M.NTSC Video recorders (VCR).
	NTSC (AV input only)	Playback from NTSC Video recorders (VCR).
Receiving Systems / Band name (Y)	PAL B, G, H, I, SECAM B, G, SECAM L, L'	VHF H1 - H2 (ITALY) UHF E21 - E69 CATV S1 - S10 (M1 - M10) CATV S21 - S41 (Hyperband)
	VHF E2 - E12	VHF H1 - H2 (ITALY)
	VHF A - H (ITALY)	UHF E21 - E69
	CATV (S01 - S05)	CATV S1 - S10 (M1 - M10)
	CATV S11 - S20 (U1 - U10)	CATV S21 - S41 (Hyperband)
	PAL D, K, SECAM D, K	VHF R3 - R5 UHF E21 - E69
	VHF R1 - R2	VHF R3 - R5
	VHF R6 - R12	UHF E21 - E69
	PAL 525/60	Playback of NTSC tape from some PAL Video recorders (VCR)
	M.NTSC	Playback from M. NTSC Video recorders (VCR)
	NTSC (AV input only)	Playback from NTSC Video recorders (VCR)
	DVB-T/T2	Digital terrestrial services (MPEG2 and MPEG4-AVC(H.264))
	DVB-C	Digital cable services (MPEG2 and MPEG4-AVC(H.264))
	<ul style="list-style-type: none"> • Check the latest information on the available services at the following website. (English only) http://panasonic.jp/support/global/cs/tv/ 	
Aerial input	UHF (UK)	VHF / UHF (Ireland/Y)
Operating Conditions	Temperature:	0 °C- 35 °C
	Humidity:	20 % - 80 % RH (non-condensing)
Connection Terminals		
AV1 (SCART)	21 Pin terminal (Audio/Video in, Audio/Video out, RGB in, Q-Link)	
AV2 input	VIDEO:	RCA PIN Type × 1 1.0 V [p-p] (75 Ω)
	AUDIO L-R:	RCA PIN Type × 2 0.5 V [rms]
COMPONENT input	Y:	1.0 V [p-p] (including synchronization)
	P_B, P_R:	±0.35 V [p-p]
HDMI1 / 2 / 3 input	TYPE A Connectors	
	HDMI1 / 3 :	3D, Content Type, Deep Colour, x.v.Colour™
	HDMI2 :	3D, Content Type, Audio Return Channel, Deep Colour, x.v.Colour™
	<ul style="list-style-type: none"> • This TV supports " HDAVI Control 5 " function. 	
Card slot	SD CARD slot × 1 Common Interface slot (complies with CI Plus (Y)) × 1	
ETHERNET	RJ45, IEEE802.3 10BASE-T / 100BASE-TX	
USB 1 / 2	USB2.0 DC 5 V, Max. 500 mA	
AUDIO IN	RCA PIN Type × 2	0.5 V [rms]

AUDIO OUT	RCA PIN Type × 2	0.5 V [rms] (high impedance)
DIGITAL AUDIO OUT	PCM / Dolby Digital / DTS, Fiber optic	
Dimensions (W × H × D)	1,023 mm × 671 mm × 320 mm (With Pedestal)	
	1,023 mm × 637 mm × 93 mm (TV only)	
Mass	27.5 kg Net (With Pedestal)	
	24.0 kg Net (TV only)	

Note

- Design and Specifications are subject to change without notice. Mass and Dimensions shown are approximate.
- This equipment complies with the EMC standards listed below.
EN55013, EN61000-3-2, EN61000-3-3, EN55020, EN55022, EN55024

5 Technical Descriptions

5.1. Specification of KEY for CI Plus, DTCP-IP, WIDEVINE and One-to-One

5.1.1. General information:

1. EEPROM (IC8902) for spare parts has the seed of KEY for each.
2. The final KEY data will be generated by Peaks IC (IC8000) when SELF CHECK was done and are stored in both Peaks IC (IC8000) and EEPROM (IC8902).

Three KEY are not generated for all models.

The necessary KEY are only generated and stored depend on the feature of models.

5.1.2. Replacement of ICs:

When Peaks IC (IC8000) is replaced, EEPROM (IC8902) should be also replaced with new one the same time.

When EEPROM (IC8902) is replaced, Peaks IC (IC8000) is not necessary to be replaced the same time.

After the replacement of IC, SELF CHECK should be done to generate the final KEY data.

How to SELF CHECK: While pressing [VOLUME (-)] button on the main unit, press [MENU] button on the remote control for more than 3 seconds.

TV will be forced to the factory shipment setting after this SELF CHECK.

5.1.3. Model and Keys:

Model No.	Keys			
	One-to-One (For USB Rec.)	CI Plus	DTCP-IP	WIDEVINE
TX-P42UT30B	None	None	None	Yes
TX-P42UT30Y	None	Yes	None	Yes

6 Service Mode

6.1. How to enter into Service Mode

6.1.1. Purpose

After exchange parts, check and adjust the contents of adjustment mode.

While pressing [VOLUME (-)] button of the main unit, press [0] button of the remote control three times within 2 seconds.

Note:

Service Mode can not be entered when 3D signal input.

Input 2D signal to enter Service Mode.

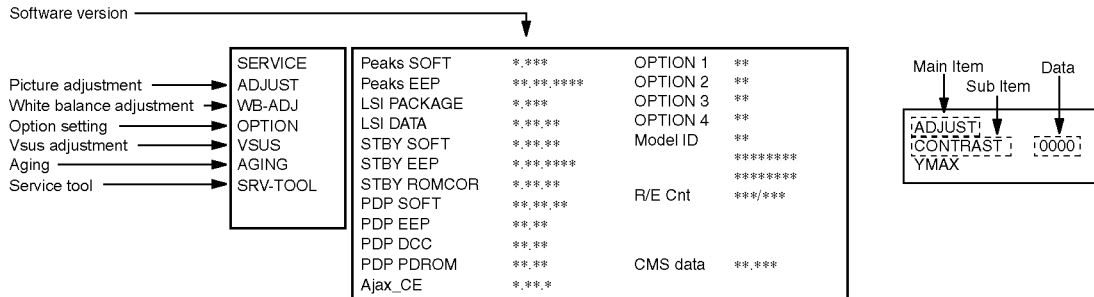

6.1.2. Key command

- [1] button...Main items Selection in forward direction
- [2] button...Main items Selection in reverse direction
- [3] button...Sub items Selection in forward direction
- [4] button...Sub items Selection in reverse direction
- [RED] button...All Sub items Selection in reverse direction
- [GREEN] button...All Sub items Selection in forward direction
- [VOL] button...Value of sub items change in forward direction (+), in reverse direction (-)

6.1.3. How to exit

Switch off the power with the [POWER] button on the main unit or the [POWER] button on the remote control.

6.1.4. Contents of adjustment mode

- Value is shown as a hexadecimal number.
- Preset value differs depending on models.
- After entering the adjustment mode, take note of the value in each item before starting adjustment.

Main item	Sub item	Sample Data	Remark
ADJUST	CONTRAST	277	
	COLOR	36	
	TINT	00	
	SUB-BRT	800	
	H-POS	0	
	H-AMP	0	
	V-POS	0	
	V-AMP	0	
WB-ADJ	R-CUT	80	
	G-CUT	80	
	B-CUT	80	
	R-DRV	EE	
	G-DRV	FF	
	B-DRV	86	
	ALL-CUT	80	
	ALL-DRV	FF	
OPTION	Panel-Type	42FHD	Factory Preset
	Boot	ROM	
	STBY-SET	00	
	EMERGENCY	ON	
	Y/C Delay		
	OPT 1	00010100	
	OPT 2	11101110	
	OPT 3	00000001	
	OPT 4	00010000	
	EDID-CLK	MID	
	MIRROR	00 (See Option-Mirror)	
AMR-SELECT	OFF		
VSUS		LOW	See Vsus selection
AGING	ALL WHITE		Built-in test patterns can be displayed.
	ALL BLUE WITH WHITE OUTSIDE FRAME		
	ALL GREEN		
	ALL RED		
	LOW STEP WHITE		
	LOW STEP BLUE		
	LOW STEP GREEN		
	LOW STEP RED		
	WHITE DIAGONAL STRIPE		
	RED DIAGONAL STRIPE		
	GREEN DIAGONAL STRIPE		
	BLUE DIAGONAL STRIPE		
	A-ZONE & B-ZONE		
	1% WINDOW		
	COLOR BAR		
	9 POINTS BRIGHT MEASURE		
	2 DOT OUTSIDE FRAME		
	ALL BLUE		
	DOUBLE FIXED 1% WINDOW		
	VERTICAL LINE SCROLL		
	ON/OFF OR WHITE		
R/G/B/W ROTATION			
HALF FIXED ALL WHITE			
ALL WHITE WITH COUNT DISPLAY			
SRV-TOOL			See Service tool mode

Destination	B	Y
Check sum	a7a1	a7b0

6.2. Option - Mirror

Picture can be reversed left and right or up and down.

00 : Default (Normal picture is displayed)

01 : Picture is reversed left and right.

02 : Picture is reversed up and down.

00



01



02



Hint : If the defective symptom (e.g. Vertical bar or Horizontal bar) is moved by selection of this mirror, the possible cause is in A-board.

6.3. Service tool mode

6.3.1. How to access

1. Select [SRV-TOOL] in Service Mode.
2. Press [OK] button on the remote control.

	SRV-TOOL		
Display of TD2Microcode version →	TD2Microcode:0200b105		
Display of Flash ROM maker code →	Flash ROM : AD - DA		
Display of SOS History →	PTCT : 00 . 00 . 00 . 00 . 00 .	Time 00000:40	On/Off 0000022 ← POWER ON TIME/COUNT Press [MUTE] button (3 sec)

6.3.2. Display of SOS History

SOS History (Number of LED blinking) indication.

From left side; Last SOS, before Last, three occurrence before, 2nd occurrence after shipment, 1st occurrence after shipment. This indication will be cleared by [Self-check indication and forced to factory shipment setting].

6.3.3. POWER ON Time, On/Off

Note : To display TIME/COUNT menu, highlight position, then press MUTE for 3 sec.

Time : Cumulative power on time, indicated hour : minute by decimal

On/Off : Number of On/Off switching by decimal

Note : This indication will not be cleared by either of the self-checks or any other command.

6.3.4. Exit

1. Disconnect the AC cord from wall outlet or switch off the power with [Power] button on the main unit.

6.4. Hotel mode

1. Purpose

Restrict a function for hotels.

2. Access command to the Hotel mode setup menu

In order to display the Hotel mode setup menu:

While pressing [VOLUME (-)] button of the main unit, press [AV] button of the remote control three times within 2 seconds.

Then, the Hotel mode setup menu is displayed.

Hotel Mode	
Hotel Mode	Off
Initial INPUT	Off
Initial POS	Off
Initial VOL Level	Off
Maximum VOL Level	100
Button Lock	Off
Remote Lock	Off
Private Information	Keep

The diagram shows a central circle with a right-pointing arrow. Four lines radiate from the circle to four text labels: 'Select' at the top, 'Change' on the left, 'EXIT' on the right, and 'RETURN' at the bottom.

3. To exit the Hotel mode setup menu

Disconnect AC power cord from wall outlet.

4. Explain the Hotel mode setup menu

Item	Function
Hotel Mode	Select hotel mode On/Off
Initial INPUT	Select input signal modes. Set the input, when each time power is switched on. Selection : Off/Analogue/DVB(B)/DVB-C(Y)/DVB-T(Y)/AV1/AV2/COMPONENT/HDMI1/HDMI2/HDMI3 • Off: give priority to a last memory. However, Euro model is compulsorily set to TV. • AVnS/AVnC: only Euro model selectable
Initial POS	Select programme number. Selection : Off/0 to 99 • Off: give priority to a last memory
Initial VOL Level	Adjust the volume when each time power is switched on. Selection/Range : Off/0 to 100 • Off: give priority to a last memory
Maximum VOL Level	Adjust maximum volume. Range : 0 to 100
Button Lock	Select local key conditions. Selection : Off/SETUP/MENU/ALL • Off: altogether valid • SETUP: only F-key is invalid (Tuning guide (menu) can not be selected.) • MENU: only F-key is invalid (only Volume/Mute can be selected.) • ALL: altogether invalid.
Remote Lock	Select remote control key conditions. Selection : Off/SETUP/MENU • Off: altogether valid • SETUP: only Setup menu is invalid • MENU: Picture/Sound/Setup menu are invalid
Private Information	Select private information for VIERA Cast is Keep or Reset if Hotel mode is set to [On] when TV power on. Selection : Keep/Reset • Keep: private information for VIERA Cast is keep • Reset: private information for VIERA Cast is reset

6.5. Data Copy by SD Card

6.5.1. Purpose

(a) Board replacement (Copy the data when exchanging A-board):

When exchanging A-board, the data in original A-board can be copied to SD card and then copy to new A-board.

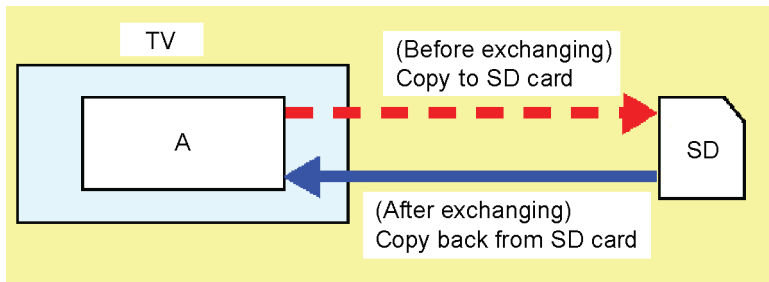

Following data can be copied.
User setting data
(incl. Hotel mode setting data)
Channel scan data
Adjustment and factory preset data

(b) Hotel (Copy the data when installing a number of units in hotel or any facility):

When installing a number of units in hotel or any facility, the data in master TV can be copied to SD card and then copy to other TVs.

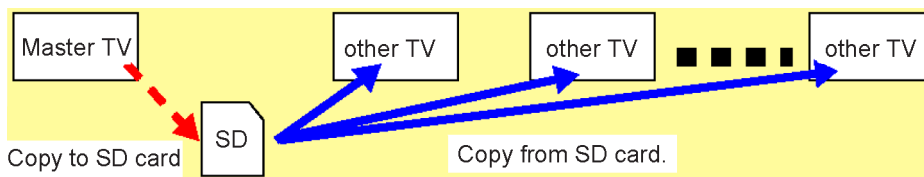

Following data can be copied.
User setting data
(incl. Hotel mode setting data)
Channel scan data

6.5.2. Preparation

Make pwd file as startup file for (a) or (b) in a empty SD card.

1. Insert a empty SD card to your PC.
2. Right-click a blank area in a SD card window, point to New, and then click text document. A new file is created by default (New Text Document.txt).
3. Right-click the new text document that you just created and select rename, and then change the name and extension of the file to the following file name for (a) or (b) and press ENTER.

File name:

- (a) For Board replacement : boardreplace.pwd
- (b) For Hotel : hotel.pwd

Note:

Please make only one file to prevent the operation error.

No any other file should not be in SD card.

6.5.3. Data copy from TV set to SD Card

1. Turn on the TV set.
2. Insert SD card with a startup file (pwd file) to SD slot.
On-screen Display will be appeared according to the startup file automatically.
3. Input a following password for (a) or (b) by using remote control.
 - (a) For Board replacement : 2770
 - (b) For Hotel : 4850Data will be copied from TV set to SD card.
It takes around 2 to 6 minutes maximum for copying.
4. After the completion of copying to SD card, remove SD card from TV set.
5. Turn off the TV set.

Note:

Following new folder will be created in SD card for data from TV set.

- (a) For Board replacement : user_setup
- (b) For Hotel : hotel

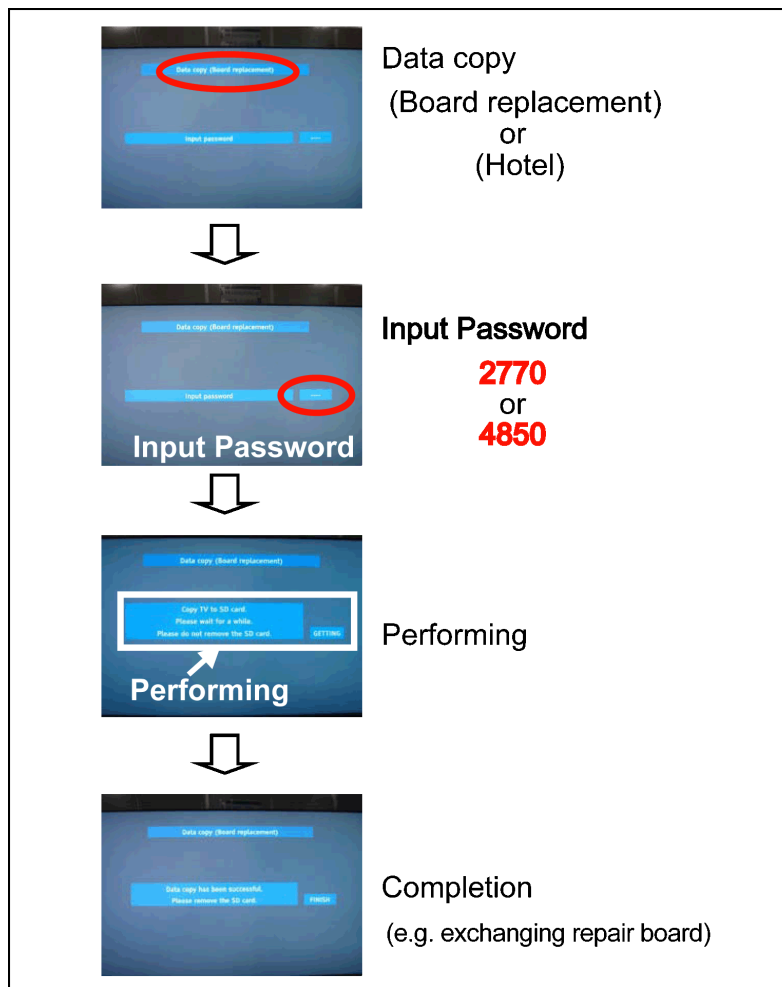

6.5.4. Data copy from SD Card to TV set

1. Turn on the TV set.
2. Insert SD card with Data to SD slot.
On-screen Display will be appeared according to the Data folder automatically.
3. Input a following password for (a) or (b) by using remote control.
(a) For Board replacement : 2771
(b) For Hotel : 4851
Data will be copied from SD card to TV set.
4. After the completion of copying to SD card, remove SD card from TV set.
(a) For Board replacement : Data will be deleted after copying (Limited one copy).
(b) For Hotel : Data will not be deleted and can be used for other TVs.
5. Turn off the TV set.

Note:

1. Depending on the failure of boards, function of Data copy for board replacement does not work.
2. This function can be effective among the same model numbers.

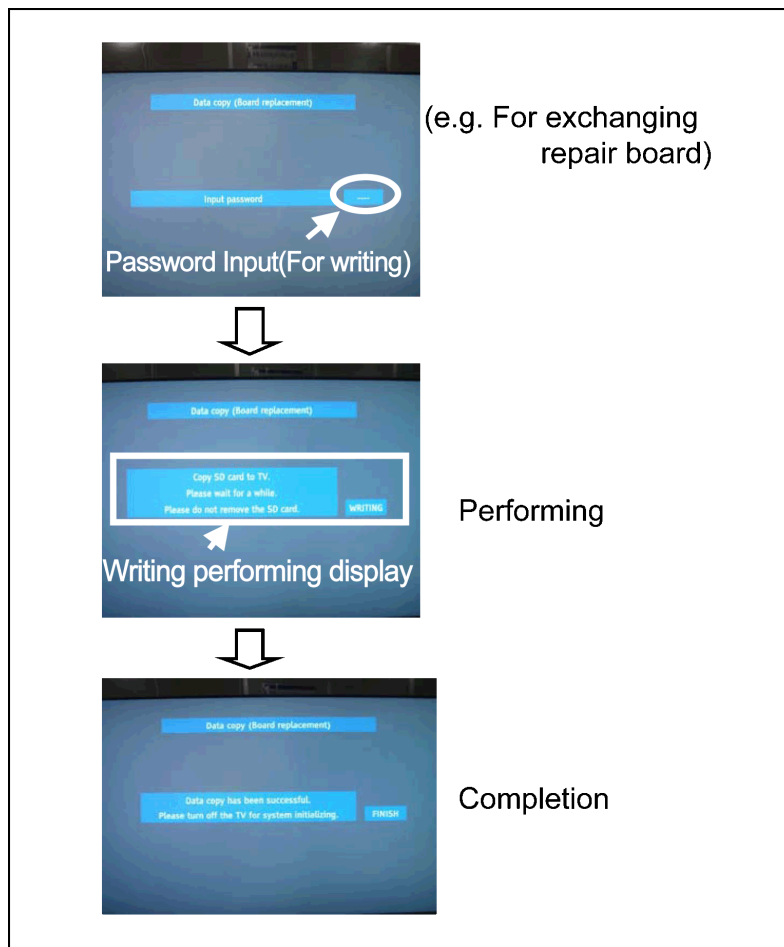

7 Troubleshooting Guide

Use the self-check function to test the unit.

1. Checking the IIC bus lines
2. Power LED Blinking timing

7.1. Check of the IIC bus lines

7.1.1. How to access

7.1.1.1. Self-check indication only:

Produce TV reception screen, and while pressing [VOLUME (-)] button on the main unit, press [OK] button on the remote control for more than 3 seconds.

7.1.1.2. Self-check indication and forced to factory shipment setting:

Produce TV reception screen, and while pressing [VOLUME (-)] button on the main unit, press [MENU] button on the remote control for more than 3 seconds.

7.1.2. Screen display

42FHD SET	Panasonic 2011PDP SELF CHECK COMPLETE																																																					
<table border="1" style="width: 100%; border-collapse: collapse;"> <tr><td>TUN</td><td>OK</td></tr> <tr><td>STBY</td><td>OK</td></tr> <tr><td>MEM1</td><td>OK</td></tr> <tr><td>MEM2</td><td>OK</td></tr> <tr><td>AVSW</td><td>OK</td></tr> <tr><td>TEMP</td><td>OK</td></tr> <tr><td>LAN</td><td>OK</td></tr> <tr><td>FE</td><td>OK</td></tr> <tr><td>ID2</td><td>OK</td></tr> <tr><td>LP1</td><td>OK</td></tr> <tr><td>IRDRV</td><td>OK</td></tr> </table>	TUN	OK	STBY	OK	MEM1	OK	MEM2	OK	AVSW	OK	TEMP	OK	LAN	OK	FE	OK	ID2	OK	LP1	OK	IRDRV	OK	<table border="1" style="width: 100%; border-collapse: collapse;"> <tr><td>PEAKS-SOFT</td><td>****</td></tr> <tr><td>PEAKS-EEP</td><td>**,**,****</td></tr> <tr><td>LSI-PACKAGE</td><td>*,**</td></tr> <tr><td>LSI-RELEASE</td><td>**,**</td></tr> <tr><td>STBY-SOFT</td><td>**,**</td></tr> <tr><td>STBY-EEP</td><td>**,**,****</td></tr> <tr><td>STBY-ROMCORR</td><td>**,**,****</td></tr> <tr><td>PDP-MCU</td><td>**,**,****</td></tr> <tr><td>PDP-EEP</td><td>**,**</td></tr> <tr><td>PDP-DCC</td><td>**,**</td></tr> <tr><td>PDP-PDROM</td><td>**,**</td></tr> </table>	PEAKS-SOFT	****	PEAKS-EEP	**,**,****	LSI-PACKAGE	*,**	LSI-RELEASE	**,**	STBY-SOFT	**,**	STBY-EEP	**,**,****	STBY-ROMCORR	**,**,****	PDP-MCU	**,**,****	PDP-EEP	**,**	PDP-DCC	**,**	PDP-PDROM	**,**	<table border="1" style="width: 100%; border-collapse: collapse;"> <tr><td>SUM</td><td>****</td></tr> <tr><td>MODEL ID</td><td>**</td></tr> <tr><td></td><td>*****</td></tr> <tr><td></td><td>*****</td></tr> </table>	SUM	****	MODEL ID	**		*****		*****
TUN	OK																																																					
STBY	OK																																																					
MEM1	OK																																																					
MEM2	OK																																																					
AVSW	OK																																																					
TEMP	OK																																																					
LAN	OK																																																					
FE	OK																																																					
ID2	OK																																																					
LP1	OK																																																					
IRDRV	OK																																																					
PEAKS-SOFT	****																																																					
PEAKS-EEP	**,**,****																																																					
LSI-PACKAGE	*,**																																																					
LSI-RELEASE	**,**																																																					
STBY-SOFT	**,**																																																					
STBY-EEP	**,**,****																																																					
STBY-ROMCORR	**,**,****																																																					
PDP-MCU	**,**,****																																																					
PDP-EEP	**,**																																																					
PDP-DCC	**,**																																																					
PDP-PDROM	**,**																																																					
SUM	****																																																					
MODEL ID	**																																																					

7.1.3. Check Point

Confirm the following parts if NG was displayed.

DISPLAY	Check Ref. No.	Description	Check P.C.B.
TUN	TU4801	TUNER	A-BOARD
STBY	IC8000	PEAKS-LDA3(STM)	A-BOARD
MEM1	IC8902	PEAKS EEPROM	A-BOARD
MEM2	IC8901	STM EEPROM	A-BOARD
AVSW	IC3001	AUDIO/VIDEO SW	A-BOARD
TEMP	IC2001	TEMP SENSOR	A-BOARD
LAN	IC8601	ETHERPHY	A-BOARD
FE	IC6700	OFDM	A-BOARD
ID2			A-BOARD
LP1	IC9300	LP1	A-BOARD
IRDRV	IC5901	IR LED DRIVER	A-BOARD

7.1.4. Exit

Disconnect the AC cord from wall outlet or switch off the power with [Power] button on the main unit.

7.2. Power LED Blinking timing chart

1. Subject

Information of LED Flashing timing chart.

2. Contents

When an abnormality has occurred the unit, the protection circuit operates and reset to the stand by mode. At this time, the defective block can be identified by the number of blinks of the Power LED on the front panel of the unit.

Blinking Times	Contents	Check point
1	Panel information SOS PD5 Start SOS	-
3	P+ 3.3V SOS	A-Board
4	Power SOS	P-Board
5	P+ 5V SOS	A-Board
6	Driver SOS1 (SN Energy recovery circuit) (A-SN FPC DET)	SN-Board A-SN FPC
7	Driver SOS2 (SN Connector DET) (SN Scan and Logic IC)	SN-Board
8	Driver SOS3 (SS FPC DET) (SS Energy recovery circuit)	SS-Board SS FPC
9	Discharge Control SOS	A-Board
10	Sub 5V SOS Sub 3.3V SOS Tuner power SOS	A-Board SN-Board SS-Board P-Board
12	Sound SOS	A-Board Speaker
13	Emergency SOS	A-Board
14	IROM SOS (ROM in Peaks IC)	A-Board P-Board

7.3. No Power

First check point

There are following 3 states of No Power indication by power LED.

1. No lit.
2. Green is lit then turns red blinking a few seconds later. (See 7.2.)
3. Only red is lit.

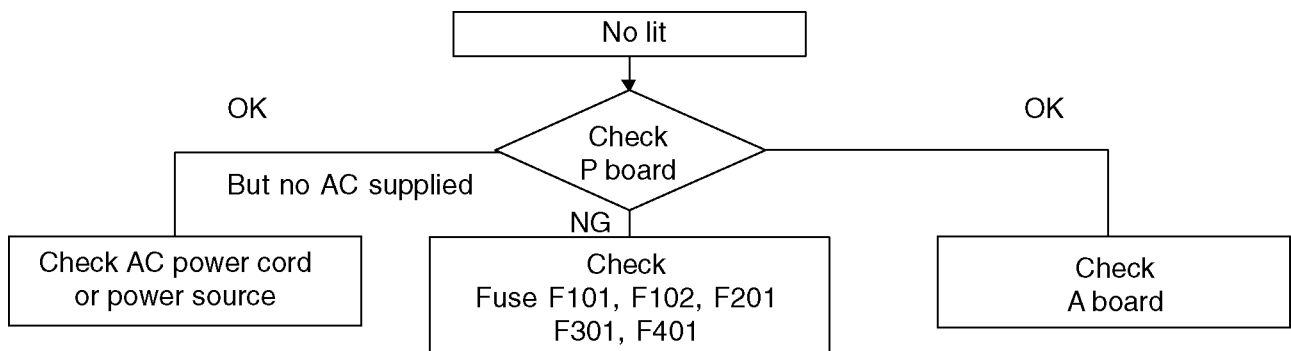

7.4. No Picture

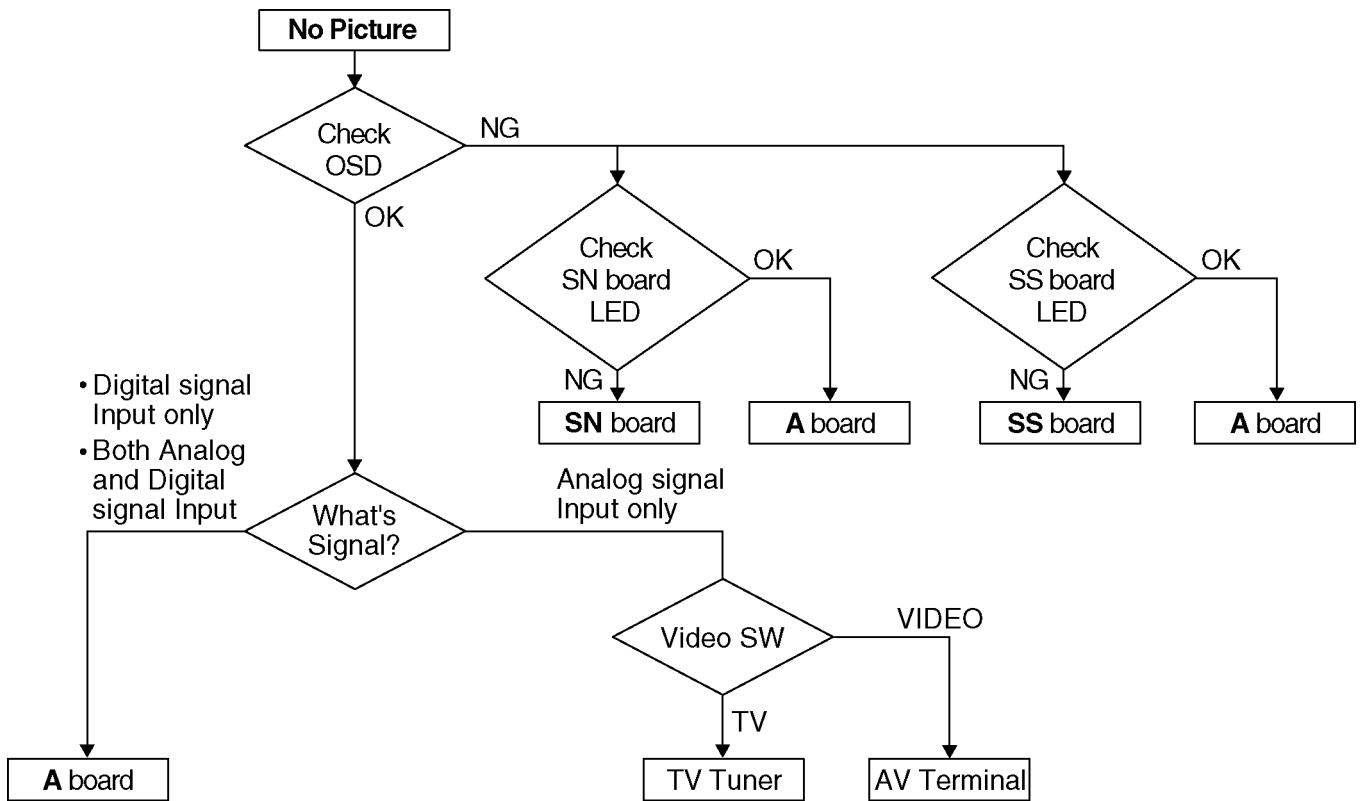

Drive circuits LED indicator

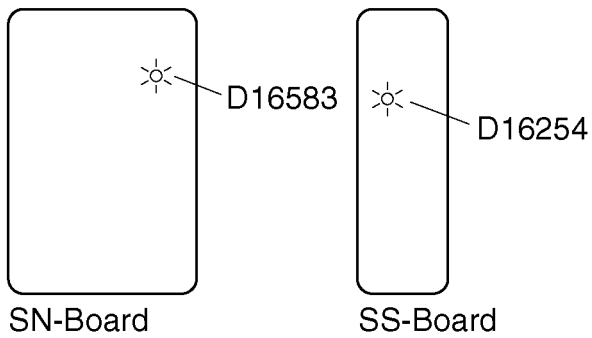

7.5. Local screen failure

Plasma display may have local area failure on the screen. Fig-1 is the possible defect P.C.B. for each local area.

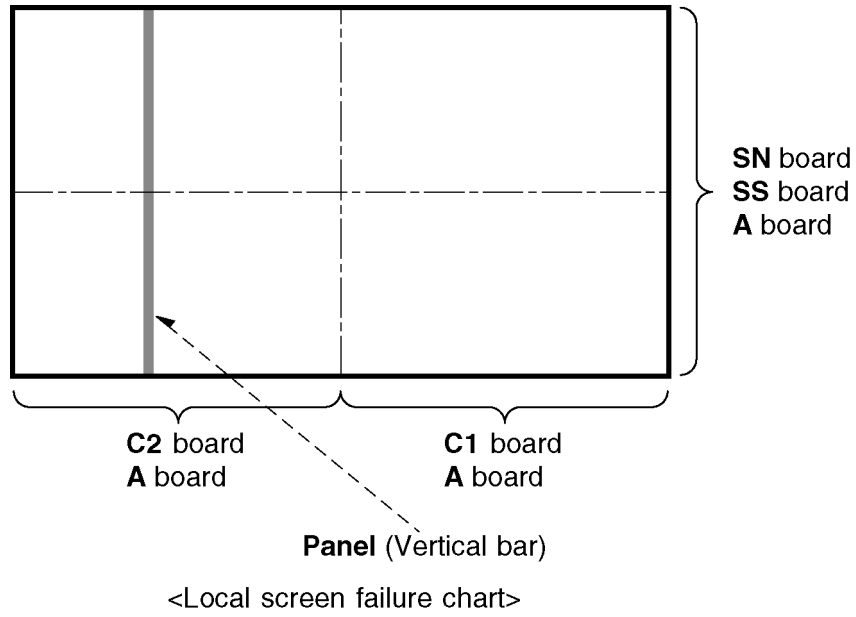

Fig-1

8 Disassembly and Assembly Instructions

8.1. Remove the Rear cover

1. See PCB Layout (Section 3)

8.2. Remove the AC inlet

Caution:

To remove P.C.B. wait 1 minute after power was off for discharge from electrolysis capacitors.

1. Disconnect the connector (P9).
2. Remove the screw (×1 ➡) and remove the AC inlet.

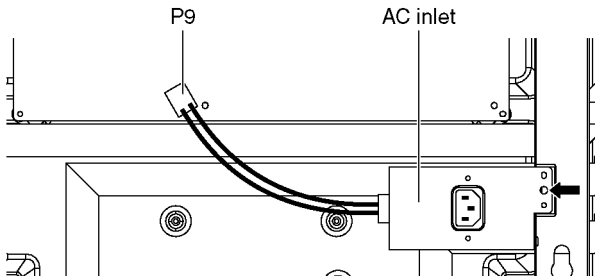

8.3. Remove the P-Board

Caution:

To remove P.C.B. wait 1 minute after power was off for discharge from electrolysis capacitors.

1. Disconnect the connectors (P2, P6, P9, P11, P34 and P35).
2. Remove the screws (×7 ➡) and remove the P-Board.

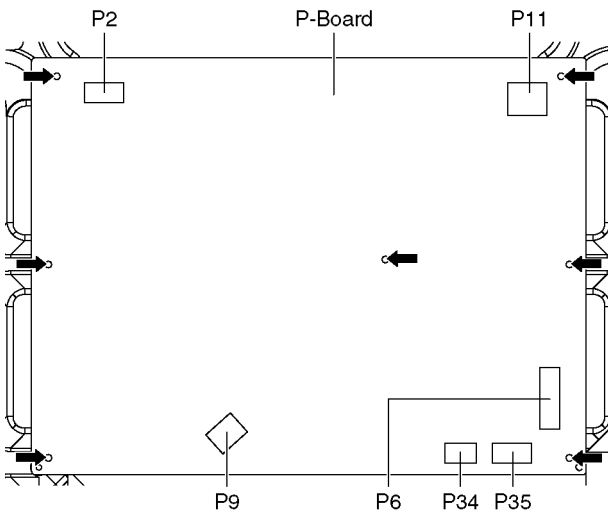

8.4. Remove the Side terminal cover

1. Remove the screws (×2 ➡).
2. Remove the Side terminal cover.

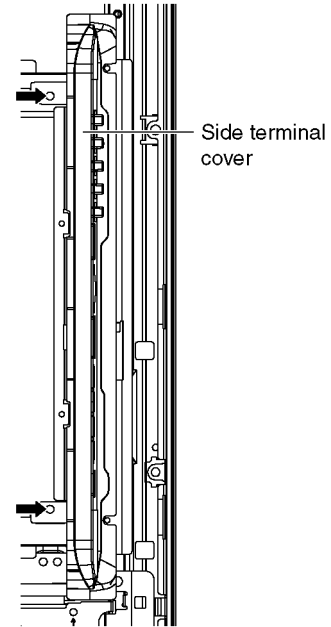

8.5. Remove the Tuner unit

1. Remove the Side terminal cover. (See section 8.4.)
2. Unlock the cable clampers to free the cable.
3. Disconnect the connectors (A1, A6, A11, A14 and A35).
4. Disconnect the flexible cables (A20, A31 and A32).
5. Remove the screws (×3 ➡) and remove the Tuner unit.

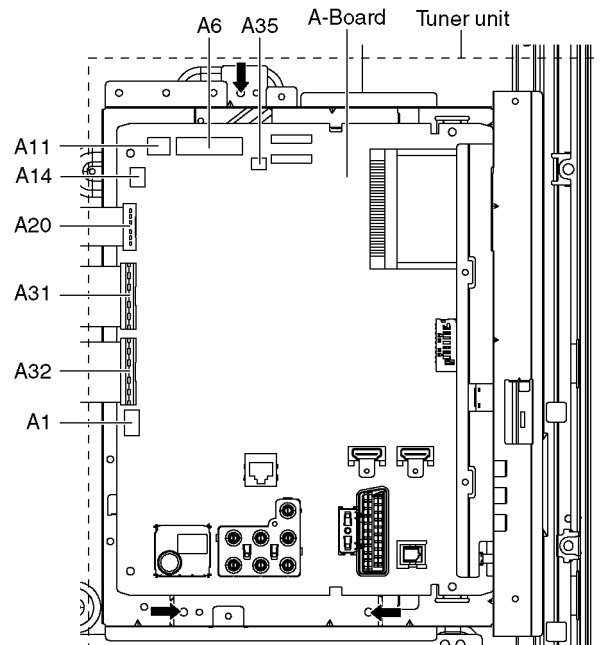

8.6. Remove the A-Board

1. Remove the Tuner unit. (See section 8.5.)
2. Remove the screws ($\times 2$ \Rightarrow , $\times 1$ \Rightarrow) and remove the A-Board.

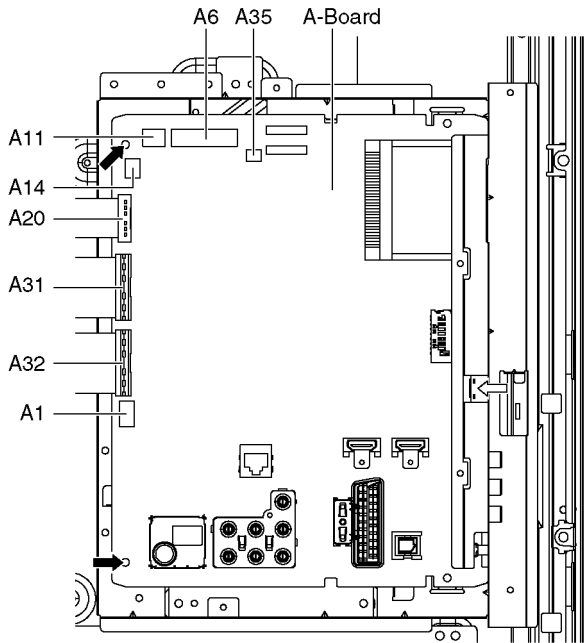

8.7. Remove the Speakers

1. Unlock the cable clampers to free the cable.
2. Disconnect the Speaker terminal.
3. Remove the screws ($\times 2$ \Rightarrow each) and remove the Speakers (L, R).

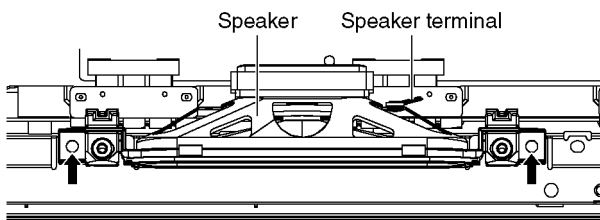

8.8. Remove the SN-Board

1. Disconnect the flexible cables (SN21, SN22, SN23, SN24, SN25, SN26, SN27 and SN28) connected to the SN-Board.
2. Disconnect the connector (SN2).
3. Disconnect the flexible cable (SN20).
4. Remove the screws ($\times 8$ \Rightarrow) and remove the SN-Board.

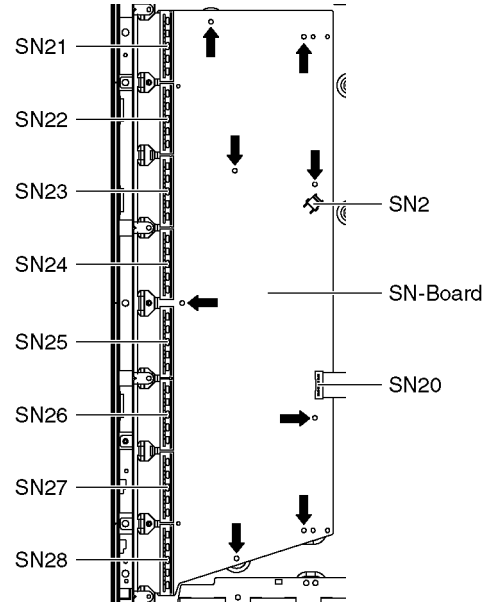

8.9. Remove the SS-Board

1. Remove the Tuner unit. (See section 8.5.)
2. Disconnect the connector (SS11).
3. Disconnect the flexible cable (SS33).
4. Disconnect the flexible cables (SS61 and SS66).
5. Remove the screws ($\times 5$ \Rightarrow) and remove the SS-Board.

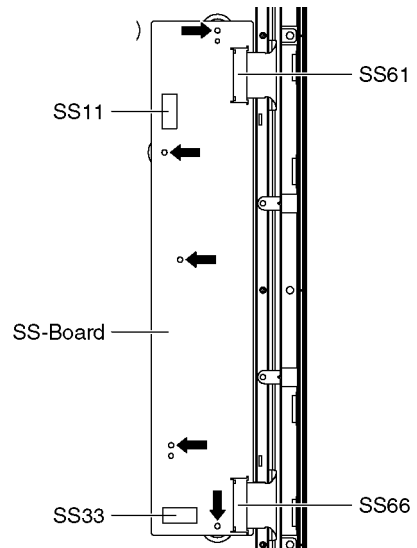

8.10. Remove the Stand bracket and the Hanger metals

1. Remove the Plasma panel section from the servicing stand and lay on a flat surface such as a table (covered by a soft cloth) with the Plasma panel surface facing downward.
2. Unlock the cable clampers to free the cable.
3. Remove the AC inlet. (See section 8.2.)
4. Remove the Stand bracket fastening screws (×5 ➡) and remove the Stand bracket.

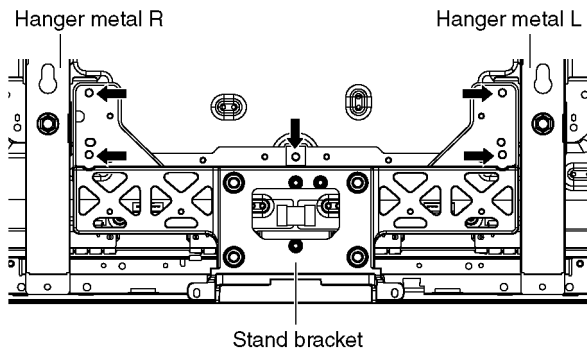

5. Remove the Hanger metals (L, R) fastening screws (×2 ➡ each) and remove the Hanger metals (L, R).

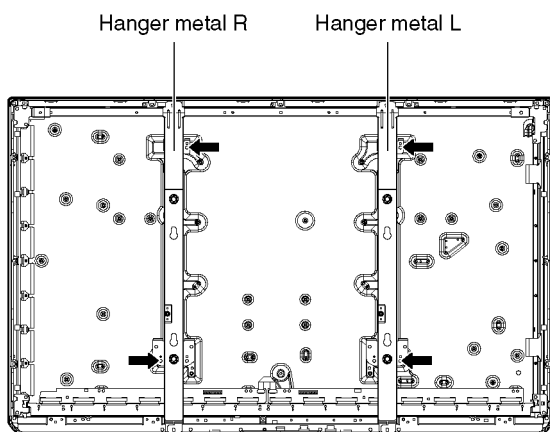

8.11. Remove the Plasma panel section from the Cabinet assy

1. Remove the Plasma panel fastening screws (×4 ➡) and remove the Cabinet assy.

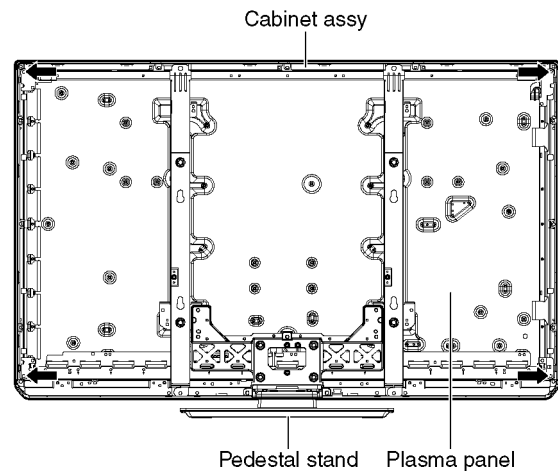

2. For leaving the Cabinet assy from the Plasma panel, pull the bottom of the Cabinet assy forward, lift, and remove.

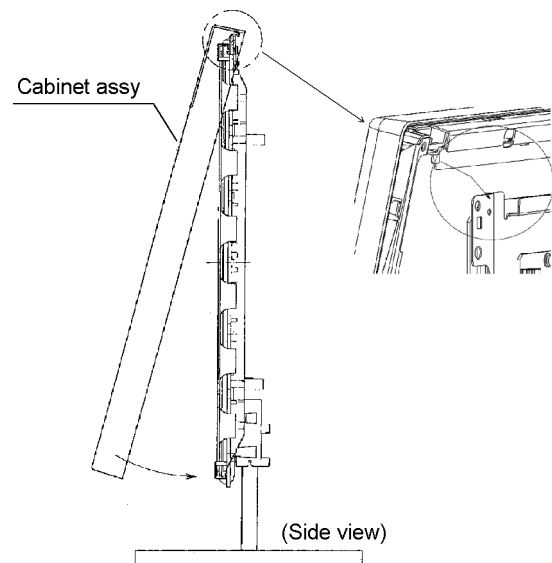

8.12. Remove the Radiator plate

1. Remove the Stand bracket and the Hanger metals. (See section 8.10.)
2. Remove the screws (×15 ➡) and remove the Radiator plate.

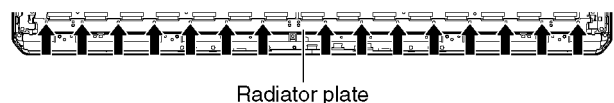

8.13. Remove the C1-Board

1. Remove the Radiator plate. (See section 8.12.)
2. Disconnect the flexible cables (CB1, CB2, CB3, CB4, CB5, CB6 and CB7).
3. Disconnect the flexible cables (C10 and C11).
4. Remove the screws (×4 ➡) and remove the C1-Board.

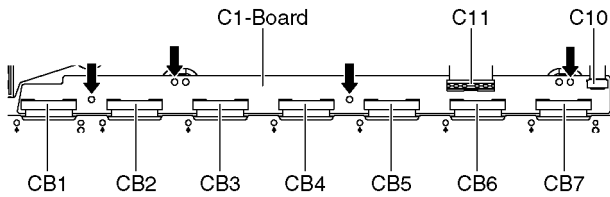

8.14. Remove the C2-Board

1. Remove the Radiator plate. (See section 8.12.)
2. Disconnect the flexible cables (CB8, CB9, CB10, CB11, CB12, CB13, CB14 and CB15).
3. Disconnect the flexible cables (C20, C21 and C23).
4. Disconnect the connector (C25).
5. Remove the screws (×4 ➡) and remove the C2-Board.

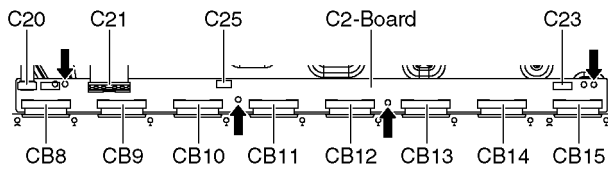

8.15. Remove the Attachment metal bottom

1. Remove the Radiator plate. (See section 8.12.)
2. Remove the screws (×1 ➡ each) and remove the Attachment metal bottom (L, R).

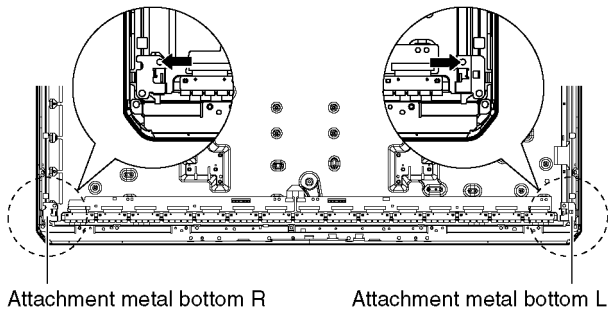

8.16. Remove the Attachment metal top

1. Remove the Cabinet assy. (See section 8.11.)
2. Remove the screws (×2 ➡, ×2 ⇨) and remove the Attachment metal top (L, R).

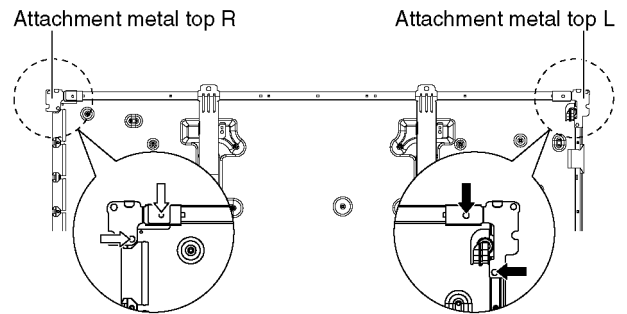

8.17. Remove the Glass holders

1. Remove the Cabinet assy. (See section 8.11.)
2. Remove the screws (×5 ⇨).
3. Remove the Glass holder top.
4. Remove the screws (×5 ➡).
5. Remove the Glass holder bottom.
6. Remove the screws (×4 ➡).
7. Remove the Glass holder side (L, R).

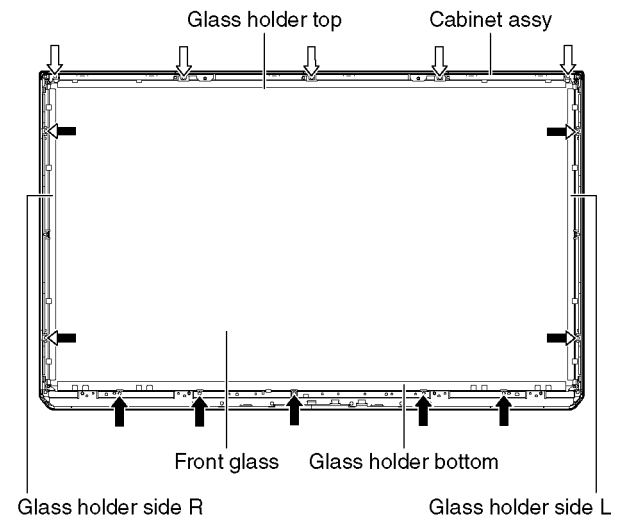

8.18. Remove the K-Board

1. Remove the Glass holder bottom. (See section 8.17.)
2. Remove the claw (×1 ⇨).
3. Disconnect the connector (K1) and Remove the K-Board from LED Panel.

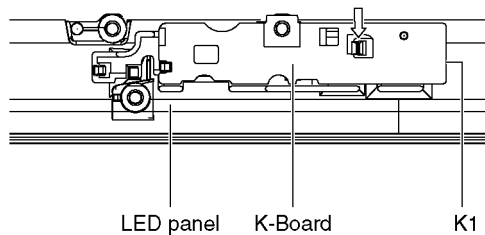

8.19. Remove the V-Board

1. Remove the Glass holder bottom. (See section 8.17.)
2. Remove the screw (×1 ➡).
3. Remove the claw (×1 ⇨).
4. Disconnect the connector (V14) and remove the V-Board from the 3D emitter panel.

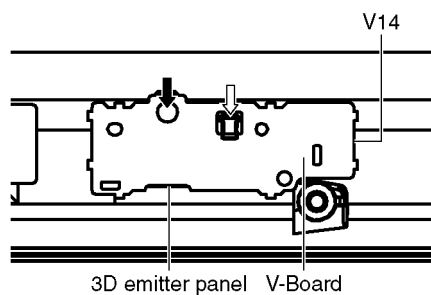

8.20. Replace the Plasma panel

Caution:

A new Plasma panel itself without Hanger metals is fragile.

To avoid the damage to new Plasma panel, carry a new Plasma panel taking hold of the Hanger metals after assembling the Hanger metals and the Stand bracket.

1. Place a carton box packed a new Plasma panel on the flat surface of the work bench.
2. Open a box and without taking a new Plasma panel; Attach the C1-Board and the C2-Board, connect the flexible cables from the Plasma panel to the C1-Board and the C2-Board, and fit the Flexible cable holders.
3. Attach the Hanger metals and the Stand bracket to the new Plasma panel.
4. Place the Plasma panel on the servicing stand taking hold of the Hanger metals.
5. Attach the Cabinet assy and each P.C.Board and so on, to the new Plasma panel.

***When fitting the Cabinet assy, be careful not to allow any debris, dust or handling residue to remain between the Front glass and Plasma panel.**

9 Measurements and Adjustments

9.1. Adjustment

9.1.1. Vsus selection

Caution:

When Plasma panel or A-board is replaced, Vsus should be set to LOW or HIGH.

Procedure

1. Go into main item [VSUS] in Service Mode. LOW or HIGH will be displayed.
2. Press [OK] button to go to TEST stage.
White pattern without On-Screen Display will be displayed during TEST and CONF stage. Press [5] button to display the On-Screen Display.
3. Press [VOL (-)] button to set to LOW.
4. In LOW setting
 - a. If no several dead pixel is visible remarkably in white pattern, press [3] button to go to CONF stage.
 - b. If the several dead pixels are visible remarkably in white pattern, Set to HIGH by press [VOL (+)] button. Press [3] button to go to CONF stage if the symptom is improved.
5. Press [OK] button in CONF stage to store LOW or HIGH.
6. Exit Service Mode by pressing [Power] button.

Vsus selection in Service mode

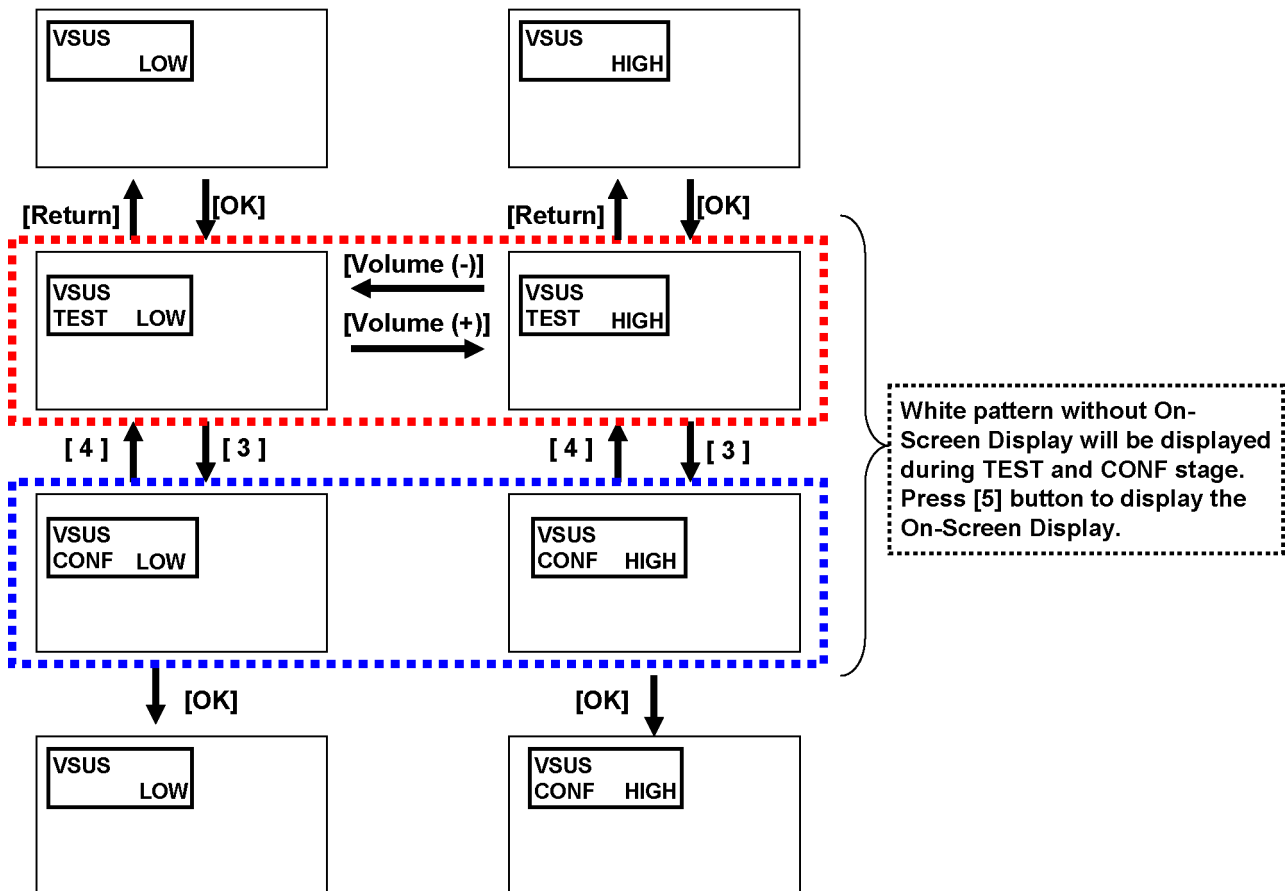

9.1.2. Sub-Contrast adjustment

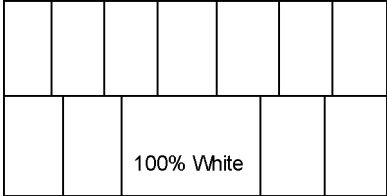
Name of measuring instrument	Connection	Remarks
RF generator Base Band signal generator HD signal generator		
Steps		Remarks
Connect IIC cable (bus controller-cable) after banner OSD appear. And after SRQ-L, begin an adjustment 2 seconds later. Adjustment of TV (RF system) Note: In adjustment, you must setting to modulation of signal at 80%(B) / 90%(Y). 1. Receive a RF PAL 100% Full White or Split Colour bar shown as below.  2. Goes into service mode. 3. Push a [1] or [2] key, and goes into adjustment mode for [CONTRAST]. Adjustment 1. The colour key yellow button of remote control is pushed. 2. The OSD character of sub-contrast becomes red. (Inside under automatic adjustment) 3. The OSD character of sub-contrast returns to black. When [NG] is displayed, adjustment failure. 4. End.		Note: Sub-contrast adjustment is unadjusted for AV/ HD input. But, when needing the adjustment chosen manually, please refer to [alternative method].

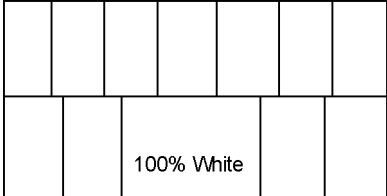
Steps	Remarks
<u>Another procedure</u> Connect IIC cable (bus controller-cable) after banner OSD appear. And after SRQ-L, begin an adjustment 2 seconds later. Adjustment of AV system 1. PAL 100% Full White or Split Colour bar receive AV1(or AV2), shown as below.  2. Goes into service mode. 3. Push [1] or [2] key, and goes into adjustment mode for [CONTRAST]. Adjustment 1. The colour key yellow button of remote control is pushed. 2. The OSD character of sub-contrast becomes red. (Inside under automatic adjustment) 3. The OSD character of sub-contrast returns to black. When [NG] is displayed, adjustment failure. 4. End.	

Steps	Remarks
<p>Another procedure</p> <p>Connect IIC cable (bus controller-cable) after banner OSD appear. And after SRQ-L, begin an adjustment 2 seconds later.</p> <p>Adjustment of HD system</p> <ol style="list-style-type: none"> At 1080i 100% Full White or Split colour bar receive component signal, as shown below. <div data-bbox="400 430 788 624" style="text-align: center;"> </div> <ol style="list-style-type: none"> Goes into service mode. Push [1] or [2] key, and goes into adjustment mode for [CONTRAST]. <p>Adjustment</p> <ol style="list-style-type: none"> The colour key yellow button of remote control is pushed. The OSD character of sub-contrast becomes red. (Inside under automatic adjustment) The OSD character of sub-contrast returns to black. When [NG] is displayed, adjustment failure. End. 	

Table1, Sub-contrast Adustment initial data in Peaks EEPROM

06E0	Y Gain Standard for NTSC-G:RF (L)	Setting data
06E1	Y Gain Standard for NTSC-G:RF (H)	
06E2	Y Gain Standard for PAL-G:RF (L)	
06E3	Y Gain Standard for PAL-G:RF (H)	
06E4	Y Gain Standard for NTSC-G:ELSE (L)	
06E5	Y Gain Standard for NTSC-G:ELSE (H)	
06E6	Y Gain Standard for PAL-G:ELSE (L)	
06E7	Y Gain Standard for PAL-G:ELSE (H)	
06E8	Y Gain Standard for YUV (L)	
06E9	Y Gain Standard for YUV (H)	

9.1.3. White balance adjustment

The adjusting method is different according to the PEAKS EEPROM version.

[copy adjustment] : Peaks EEPROM ver.1.00-

[Differential and copy adjustment] : Peaks EEPROM ver.1.-**

Name of measuring instrument	Connection	Remarks
W/ B pattern Color analyzer (Minolta CA-100 or equivalent)	Panel surface	
Steps		Remarks
<p>[copy adjustment] Connect IIC cable (bus controller-cable) after banner OSD appear. And after SRQ-L, begin an adjustment 2 seconds later.</p> <ul style="list-style-type: none"> • Make sure the front panel to be used on the final set is fitted. • Make sure a color signal is not being shown before adjustment. • Put the color analyzer where there is little colour variation. <p>Note: Copy Adjustment method in service mode. When you push [OK] key in each item, Adjustment data is copied between HD data and SD data.</p>		Picture menu : Dynamic ASPECT : 16:9 Condition is same at alternative method too.
<ol style="list-style-type: none"> 1. Enter the service mode. Please receive the Analog-RF. Or, please select CVBS/YUV/HDMI. (No inputting is possible.) (Forbid Analog-RF with no signal.) 2. A number key [1] or [2] are operated and [WB-ADJ] is displayed. Check that the color temp is [COOL]. 3. A number key [0] is operated and select [METHOD 01]. 4. A number key [5] is operated and [INNER PATTERN] is displayed. <div style="text-align: center;">  <p>INNER PATTERN</p> </div> <ol style="list-style-type: none"> 5. Select [G-CUTOFF] item, using the number-key [3] or [4], and set to [80], using the volume-key [+] or [-]. Also, [B-CUTOFF] and [R-CUTOFF] set to [80]. 6. Set [G-DRIVE] at [D0]. 7. Touch the signal receiver of color analyzer to the INNER PATTERN's center, and adjust B drive and R drive so x, y become the [COLOR TEMP COOL] in the below table1. 8. All RGB drive increase so that the maximum drive value of RGB may become [FF]. ([ALL-DRIVE] set to [FF].) 9. Set color temp to [NORMAL] using [7] key. 10. Fix G-CUTOFF, B-CUTOFF and R-CUTOFF at [80]. 11. Set [G-DRIVE] at [D0]. 12. Adjust B-DRIVE and R-DRIVE so the INNER PATTERN's x, y become the [COLOR TEMP NORMAL] in the below table1. 13. All RGB drive increase so that the maximum drive value of RGB may become [FF]. ([ALL-DRIVE] set to [FF].) 14. Set color temp to [WARM] using [7] key. 15. Fix G-CUTOFF, B-CUTOFF and R-CUTOFF at [80]. 16. Set [G-DRIVE] at [D0]. 17. Adjust B-DRIVE and R-DRIVE so the INNER PATTERN's x, y become the [COLOR TEMP WARM] in the below table1. 18. All RGB drive increase so that the maximum drive value of RGB may become [FF]. ([ALL-DRIVE] set to [FF].) 19. Confirm [METHOD=01]. <p>Please refer table2-3 to address.</p> <p>Asking matter to execute white balance difference adjustment. Please feed back the DAC value in the adjusted each color temperature in an internal pattern.</p>		METHOD=01 copy adjustments

Steps	Remarks
<p>[Differential and copy adjustment] Execute adjustment for color temp. [NORMAL], and set data for color temp. [COOL], [WARM] by data shift WB of HD (or PAL) copies the adjustment data from an adjusted format side.</p> <p>Note: The adjustment does only color temp. [NORMAL]. A adjustment value difference from [NORMAL] is written to EEPROM as for [COOL] and [WARM] by operating a [OK] key. As for WB of HD (or RF), the adjustment data from an adjusted format side is copied simultaneously. Text color of the adjusted value changes into red → black at the same time too.</p>	
<ol style="list-style-type: none"> 1. Enter the service mode. Please receive the Analog-RF. Or, please select CVBS/YUV/HDMI. (No inputting is possible.). (Forbid Analog-RF with no signal.) 2. A number key [1] and [2] are operated and [WB-ADJ] is displayed. Check that the color temp is [NORMAL]. 3. A number key [0] is operated and select [METHOD 03]. 4. A number key [5] is operated and [INNER PATTERN] is displayed. <div data-bbox="453 696 890 943" style="text-align: center;">  </div> <p style="text-align: center;">INNER PATTERN</p> <ol style="list-style-type: none"> 5. Select [G-CUTOFF] item, using the number-key [3] or [4], and set to [80], using the volume-key [+] or [-]. Also, [B-CUTOFF] and [R-CUTOFF] set to [80]. 6. Set [G-DRIVE] at [D0]. 7. Touch the signal receiver of color analyzer to the INNER PATTERN's center, and adjust B drive and R drive so x, y become the [COLOR TEMP NORMAL] in the table 1. 8. All RGB drive increase so that the maximum drive value of RGB may become [FF]. ([ALL-DRIVE] set to [FF].) 9. A number key [0] is operated and select [METHOD=01]. <p>Please refer table2-3 to address.</p>	<p>METHOD=03 Differential and copy adjustment</p>

Table 1-1, Color temp. target value (This data is target data by CA-100 in PAVCCZ.)

COLOR TEMP	x	y
COOL	0.276	0.282
NORMAL	0.298	0.318
WARM	0.312	0.333

Table 1-2, Color temp. target value (This data is target data by CS-2000 in PAVCCZ.)

COLOR TEMP	x	y
COOL	0.277	0.279
NORMAL	0.299	0.314
WARM	0.313	0.329

Table 2, Peaks EEP addresses (adjustment data)

signal / temp	Meaning of value	address
SD High	R-Cutoff for SD High	A0-070c
	G-Cutoff for SD High	A0-070d
	B-Cutoff for SD High	A0-070e
	R-Drive for SD High	A0-070f
	G-Drive for SD High	A0-0710
	B-Drive for SD High	A0-0711
SD Middle	R-Cutoff for SD Middle	A0-0712
	G-Cutoff for SD Middle	A0-0713
	B-Cutoff for SD Middle	A0-0714
	R-Drive for SD Middle	A0-0715
	G-Drive for SD Middle	A0-0716
	B-Drive for SD Middle	A0-0717
SD Low	R-Cutoff for SD Low	A0-0718
	G-Cutoff for SD Low	A0-0719
	B-Cutoff for SD Low	A0-071a
	R-Drive for SD Low	A0-071b
	G-Drive for SD Low	A0-071c
	B-Drive for SD Low	A0-071d
HD High	R-Cutoff for HD High	A0-071e
	G-Cutoff for HD High	A0-071f
	B-Cutoff for HD High	A0-0720
	R-Drive for HD High	A0-0721
	G-Drive for HD High	A0-0722
	B-Drive for HD High	A0-0723
HD Middle	R-Cutoff for HD Middle	A0-0724
	G-Cutoff for HD Middle	A0-0725
	B-Cutoff for HD Middle	A0-0726
	R-Drive for HD Middle	A0-0727
	G-Drive for HD Middle	A0-0728
	B-Drive for HD Middle	A0-0729
HD Low	R-Cutoff for HD Low	A0-072a
	G-Cutoff for HD Low	A0-072b
	B-Cutoff for HD Low	A0-072c
	R-Drive for HD Low	A0-072d
	G-Drive for HD Low	A0-072e
	B-Drive for HD Low	A0-072f

Table 3, Peaks EEP addresses (DIFF setting)

signal / temp	Meaning of value	address
SD High	R-Cutoff difference for SD High	A0-0730
	G-Cutoff difference for SD High	A0-0731
	B-Cutoff difference for SD High	A0-0732
	R-Drive difference for SD High	A0-0733
	G-Drive difference for SD High	A0-0734
	B-Drive difference for SD High	A0-0735
SD Middle	R-Cutoff difference for SD Middle	A0-0736
	G-Cutoff difference for SD Middle	A0-0737
	B-Cutoff difference for SD Middle	A0-0738
	R-Drive difference for SD Middle	A0-0739
	G-Drive difference for SD Middle	A0-073a
	B-Drive difference for SD Middle	A0-073b
SD Low	R-Cutoff difference for SD Low	A0-073c
	G-Cutoff difference for SD Low	A0-073d
	B-Cutoff difference for SD Low	A0-073e
	R-Drive difference for SD Low	A0-073f
	G-Drive difference for SD Low	A0-0740
	B-Drive difference for SD Low	A0-0741
HD High	R-Cutoff difference for HD High	A0-0742
	G-Cutoff difference for HD High	A0-0743
	B-Cutoff difference for HD High	A0-0744
	R-Drive difference for HD High	A0-0745
	G-Drive difference for HD High	A0-0746
	B-Drive difference for HD High	A0-0747
HD Middle	R-Cutoff difference for HD Middle	A0-0748
	G-Cutoff difference for HD Middle	A0-0749
	B-Cutoff difference for HD Middle	A0-074a
	R-Drive difference for HD Middle	A0-074b
	G-Drive difference for HD Middle	A0-074c
	B-Drive difference for HD Middle	A0-074d
HD Low	R-Cutoff difference for HD Low	A0-074e
	G-Cutoff difference for HD Low	A0-074f
	B-Cutoff difference for HD Low	A0-0750
	R-Drive difference for HD Low	A0-0751
	G-Drive difference for HD Low	A0-0752
	B-Drive difference for HD Low	A0-0753

10 Block Diagram

10.1. Main Block Diagram

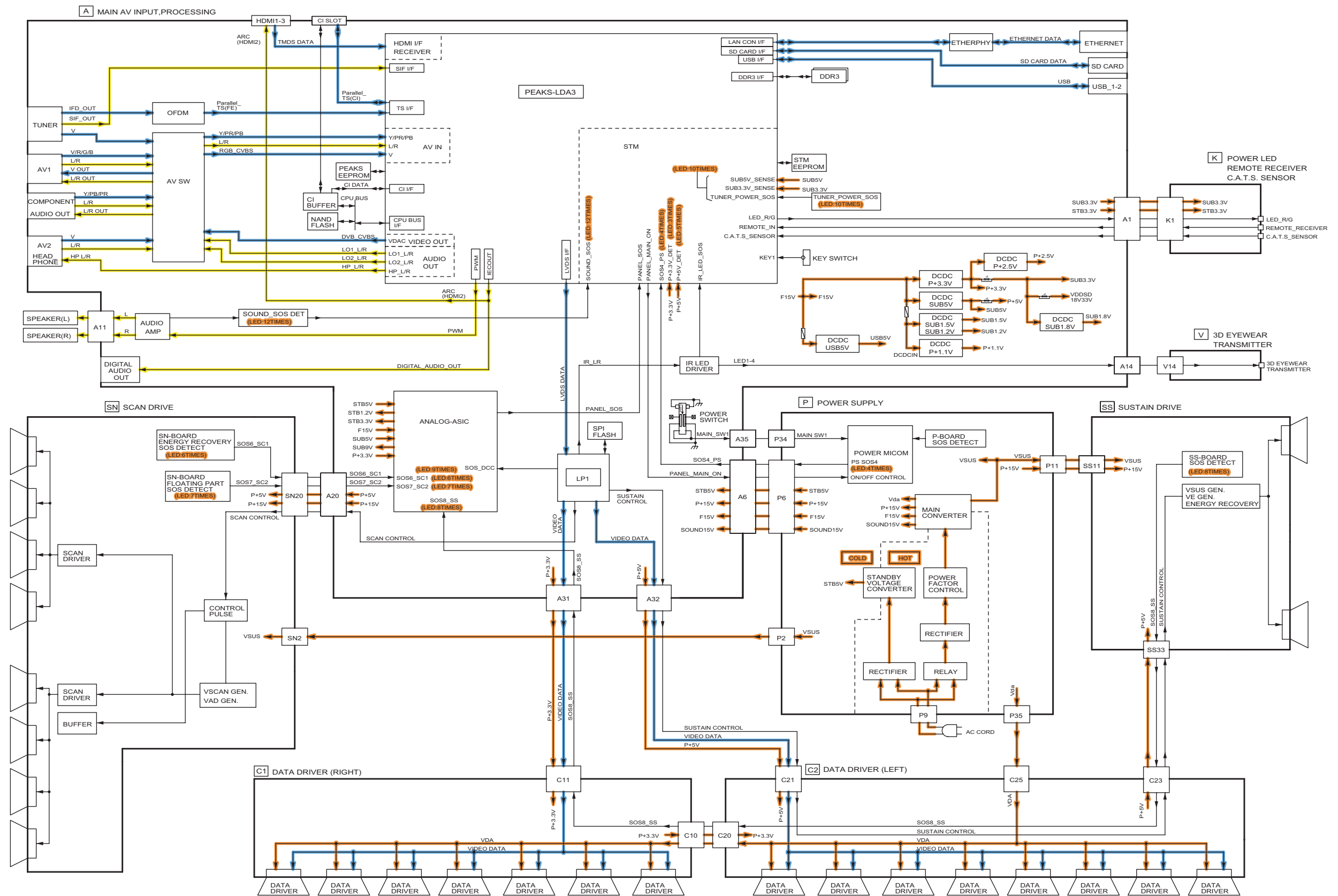

10.2. Block (1/4) Diagram

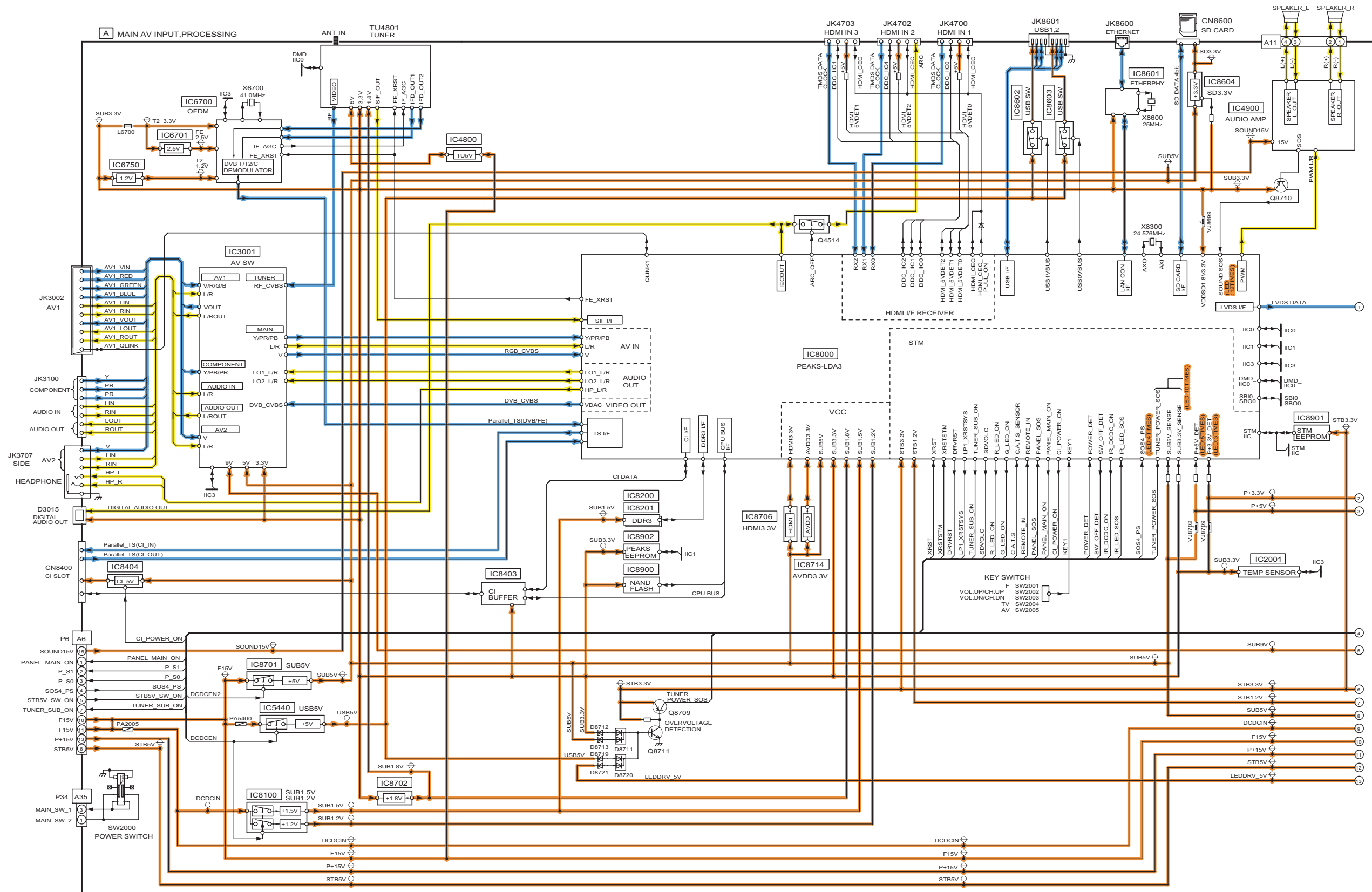

10.3. Block (2/4) Diagram

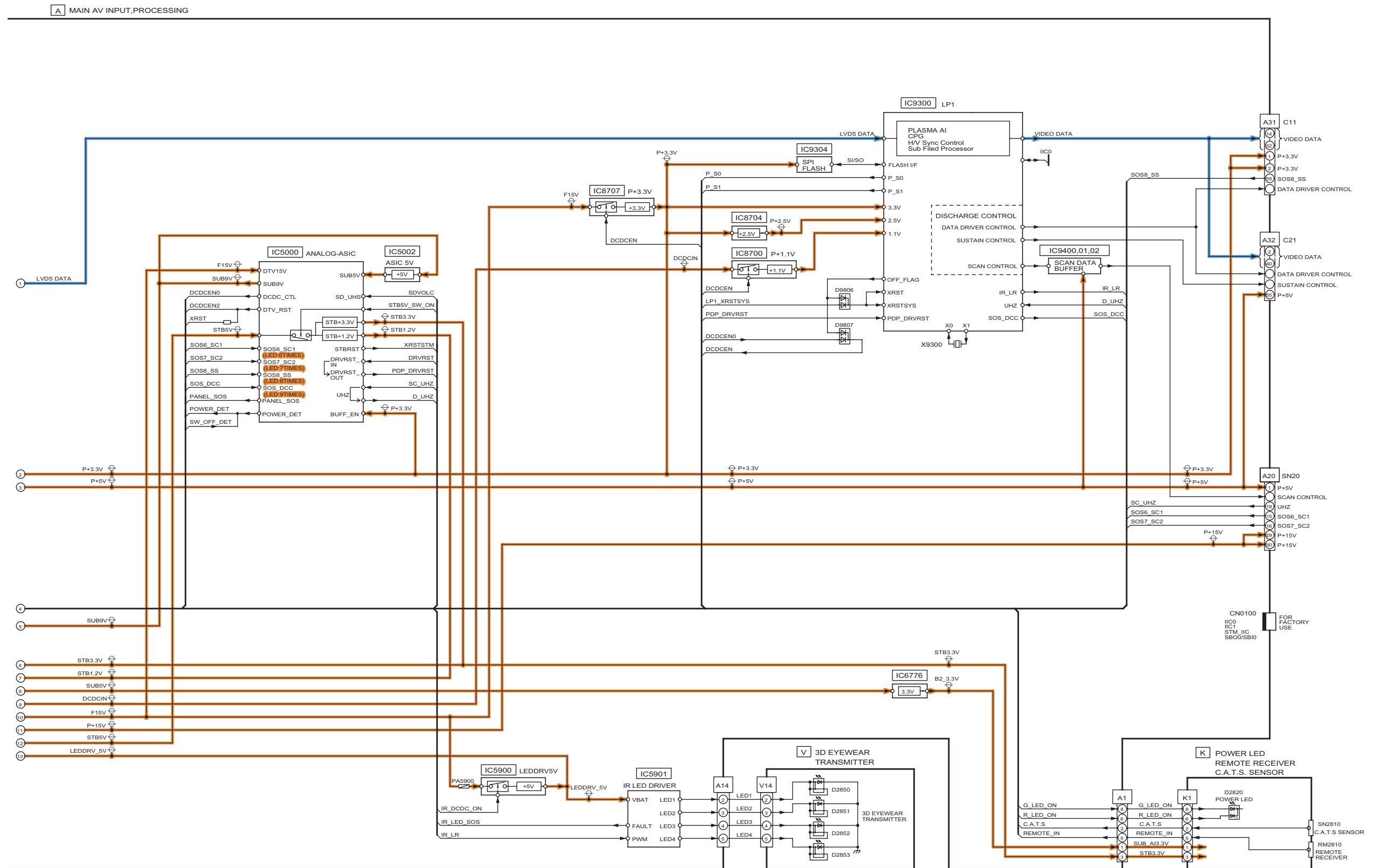

10.4. Block (3/4) Diagram

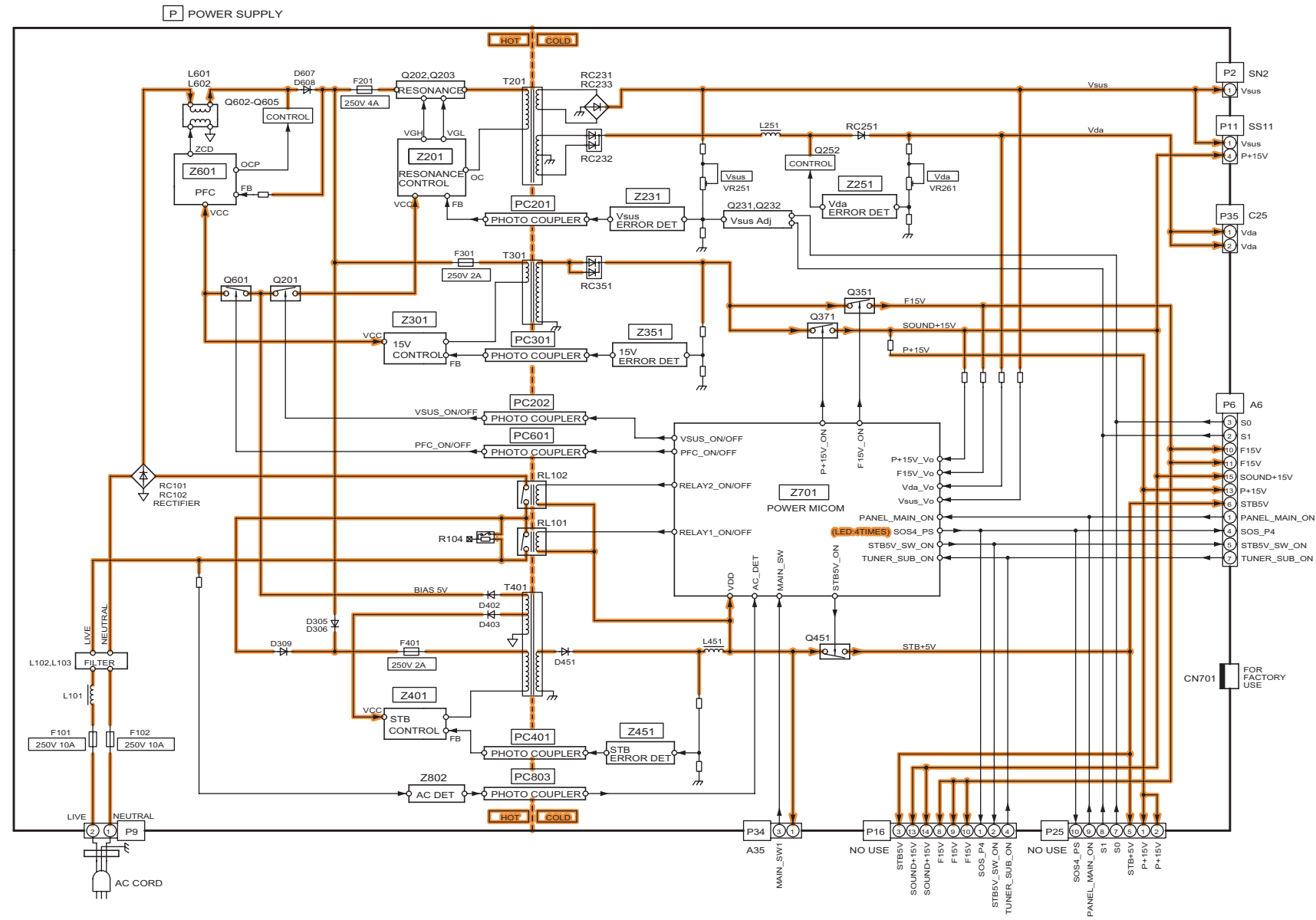

10.5. Block (4/4) Diagram

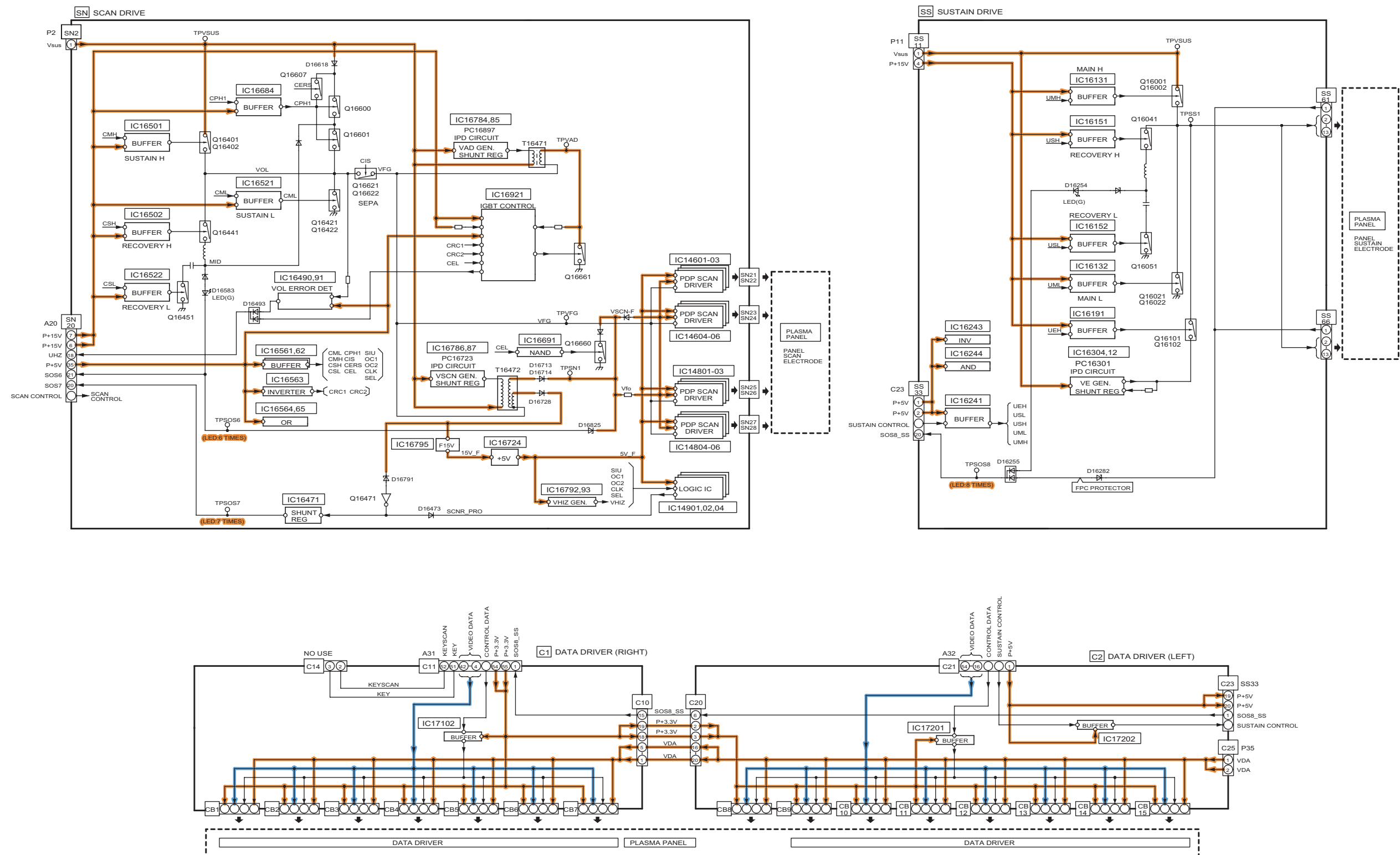

11 Wiring Connection Diagram

11.1. Caution statement.

Caution:

Please confirm that all flexible cables are assembled correctly.
Also make sure that they are locked in the connectors.
Verify by giving the flexible cables a very slight pull.

11.2. Wiring (1)

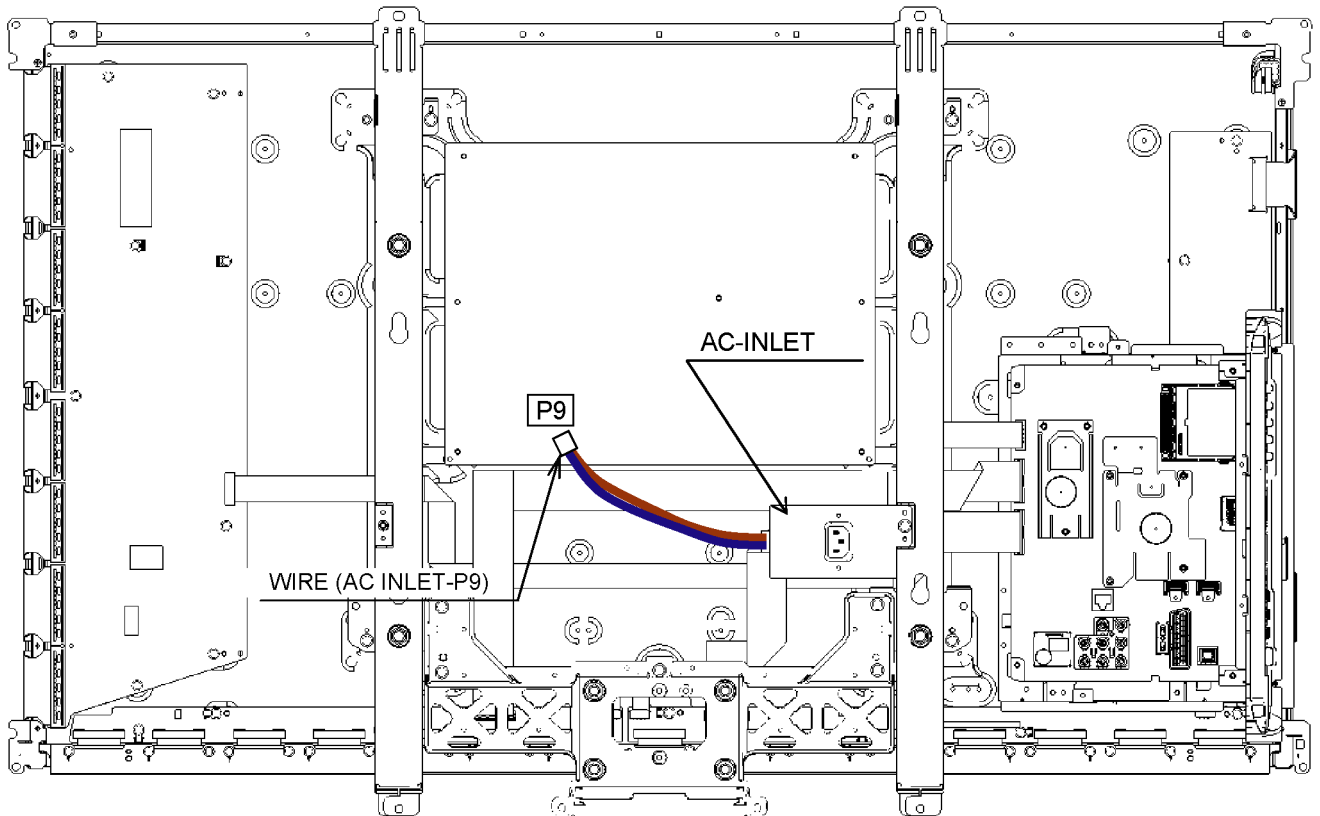

11.3. Wiring (2)

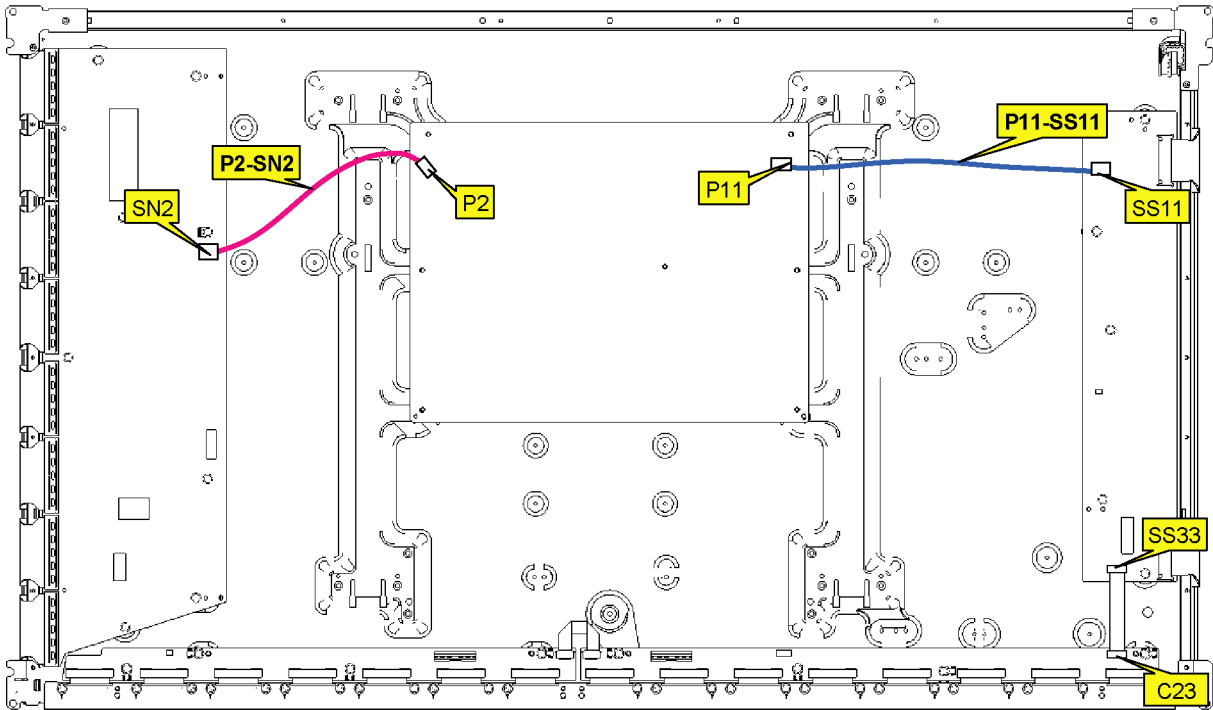

11.4. Wiring (3)

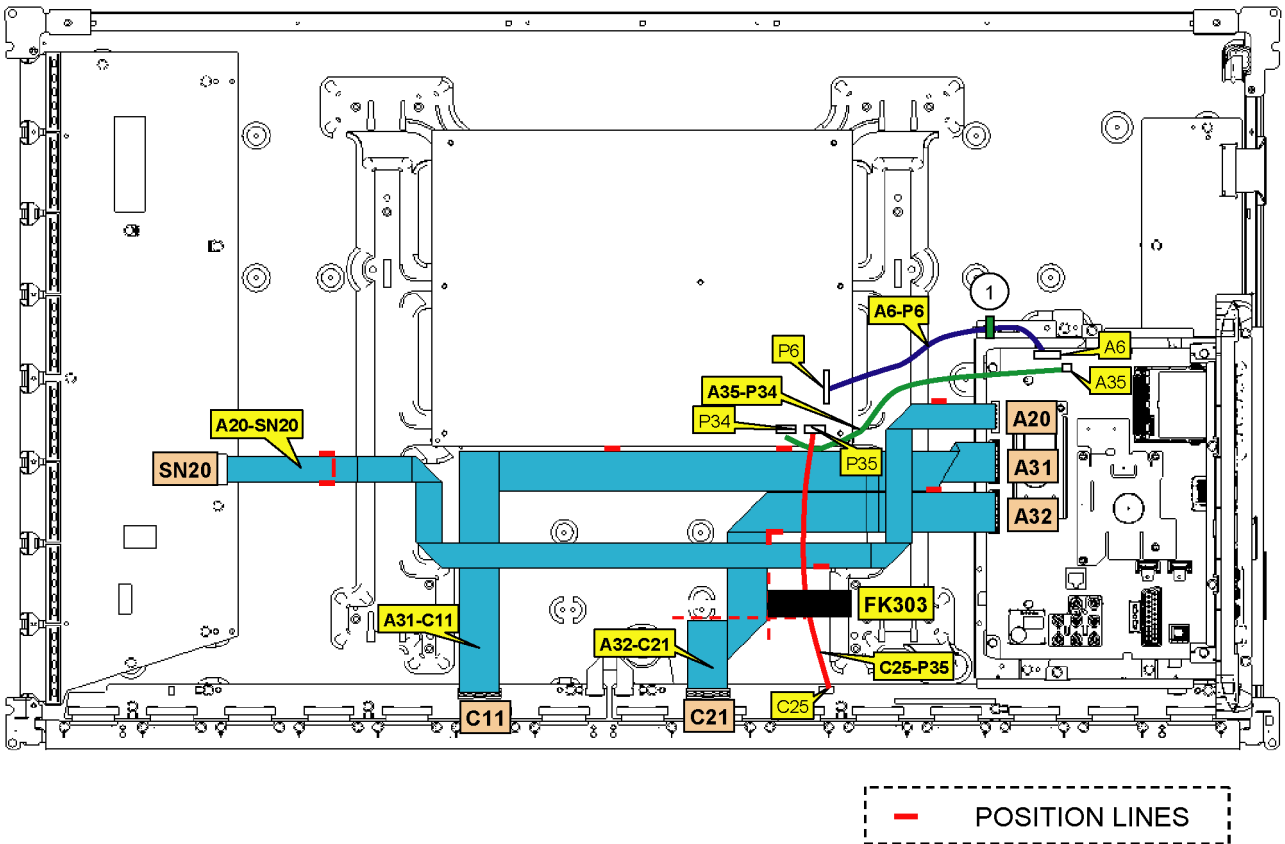

11.5. Wiring (4)

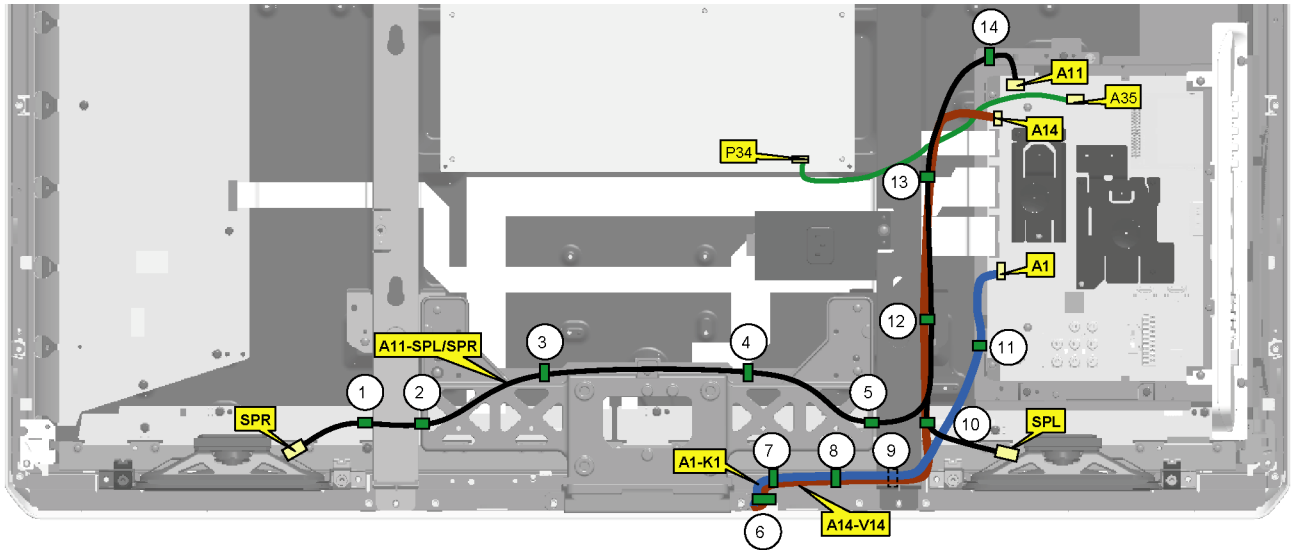





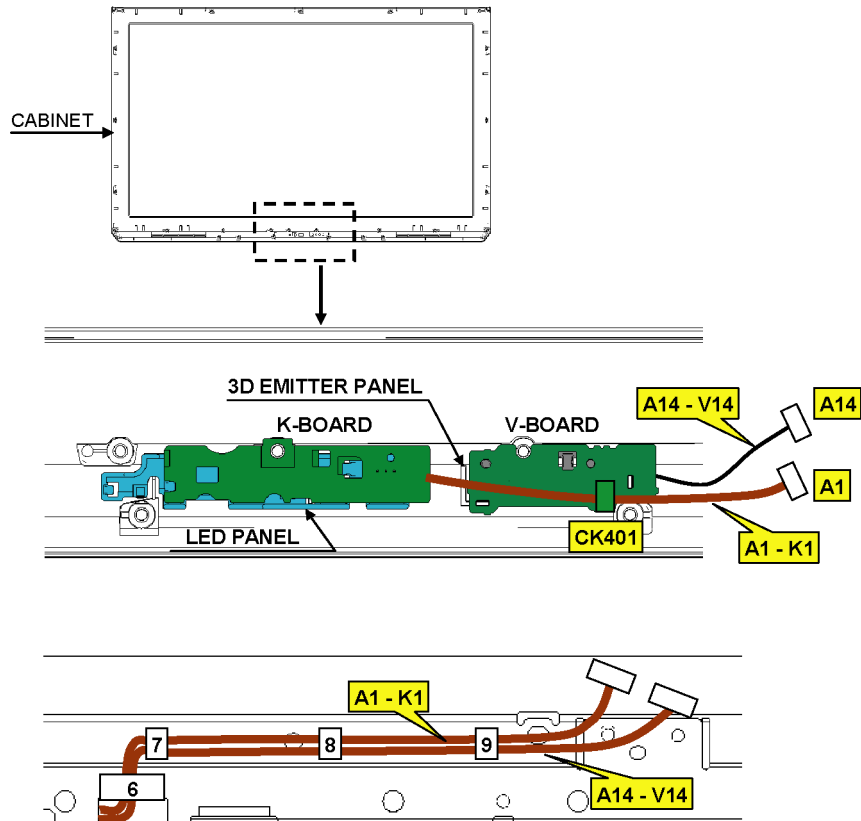

WIRE No.	1	2	3	4	5	6	7	8	9	10	11	12	13	14
A11-SPL/SPR	○	○	○	○	○					○		○	○	○
A1-K1						●	●	●	●		○			
A14-V14						●	●	●	●	○		○	○	
A35-P34														

Note:
 ● wire already lead through the clammer

11.6. Wiring (5)



Notes:

1. **Resistor**
Unit of resistance is OHM [Ω] (K=1,000, M=1,000,000).
2. **Capacitor**
Unit of capacitance is μ F, unless otherwise noted.
3. **Coil**
Unit of inductance is H, unless otherwise noted.
4. **Test Point**
 : Test Point position
5. **Earth Symbol**
 : Chassis Earth (Cold)  : Line Earth (Hot)
6. **Voltage Measurement**
Voltage is measured by a DC voltmeter.
Conditions of the measurement are the following:
Power Source AC 220-240V, 50/60Hz
Receiving Signal Colour Bar signal (RF)
All customer's controls Maximum positions
7. When arrow mark () is found, connection is easily found from the direction of arrow.
8. Indicates the major signal flow. : Video  Audio 
9. This schematic diagram is the latest at the time of printing and subject to change without notice.

Notice: Use the parts number indicated on the Replacement parts List.

Remarks:

1. The Power Circuit contains a circuit area which uses a separate power supply to isolate the earth connection.
The circuit is defined by HOT and COLD indications in the schematic diagram. Take the following precautions.
All circuits, except the Power Circuit, are cold.
Precautions
 - a. Do not touch the hot part or the hot and cold parts at the same time or you may be shocked.
 - b. Do not short-circuit the hot and cold circuits or a fuse may blow and parts may break.
 - c. Do not connect an instrument, such as an oscilloscope, to the hot and cold circuits simultaneously or a fuse may blow.
Connect the earth of instruments to the earth connection of the circuit being measured.
 - d. Make sure to disconnect the power plug before removing the chassis.

Model No. : TX-P42UT30B/Y Replacement Parts List Note

Note: All parts except parts mentioned [PAVCCZ] in the Remarks column are supplied by AVC-CSPC.
Parts mentioned [PAVCCZ] are supplied by PAVCCZ.

Notice: Be sure to make your orders of replacement parts according to this list.

RTL (Retention Time Limited)

Note: The marking (RTL) indicates that the Retention Time is Limited for this item.
After the discontinuation of this assembly in production, the item will continue to be available for a specific period of time. The retention period of availability is dependant on the type of assembly, and in accordance with the laws governing part and product retention.
After the end of this period, the assembly will no longer be available.

Abbreviation of part name and description

1. Resistor

Example:

ERD25TJ104 C 100KOHM, J 1/4W
 Type Allowance

2. Capacitor

Example:

ECKF1H103ZF C 0.01UF, Z 50V
 Type Allowance

Type	Allowance
C : Carbon	F : ±1%
F : Fuse	G : ±2%
M : Metal Oxide Metal Film	J : ±5%
S : Solid	K : ±10%
W : Wire Wound	M : ±20%

Type	Allowance
C : Ceramic	C : ±0.25pF
E : Electrolytic	D : ±0.5pF
P : Polyester	F : ±1pF
Polyprop	G : ±3pF
lene	J : ±5pF
T : Tantalum	K : ±10pF
	L : ±15pF
	M : ±20pF
	P : +100%, -0%
	Z : +80%, -20%

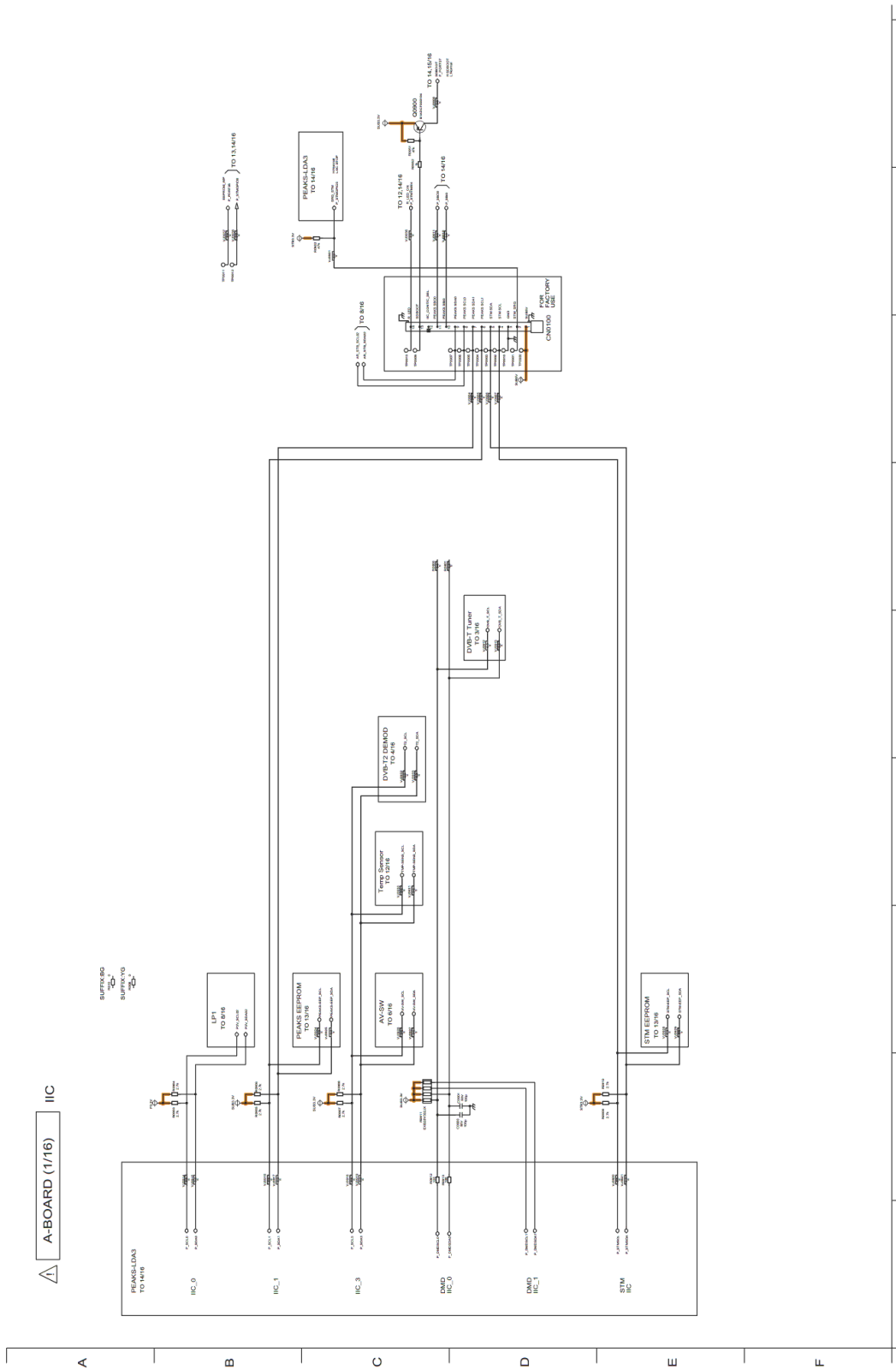

A-BOARD (2/16) HDMI INPUT

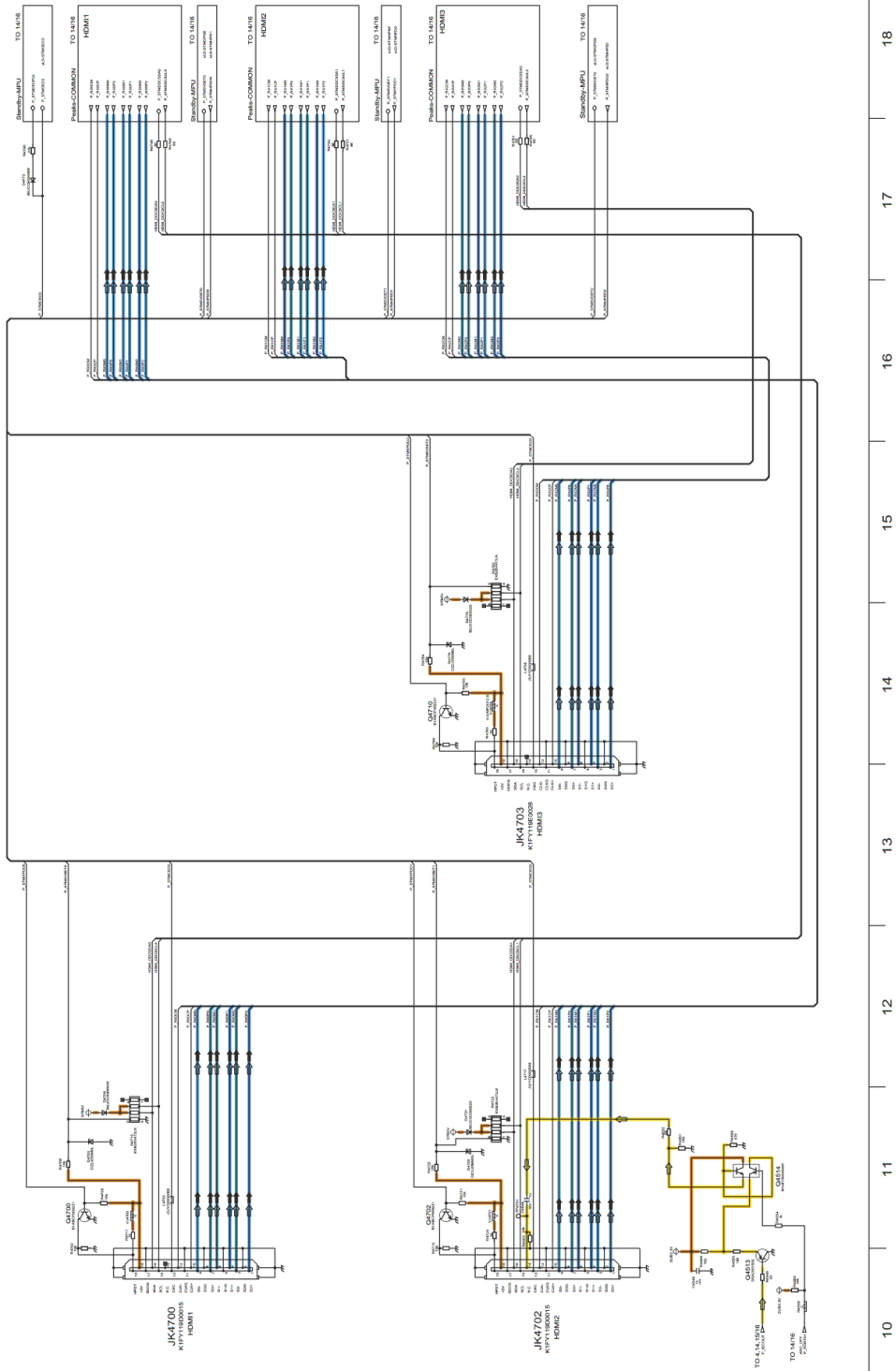

18
17
16
15
14
13
12
11
10

A-BOARD (3/16) TUNER,AUDIO AMP

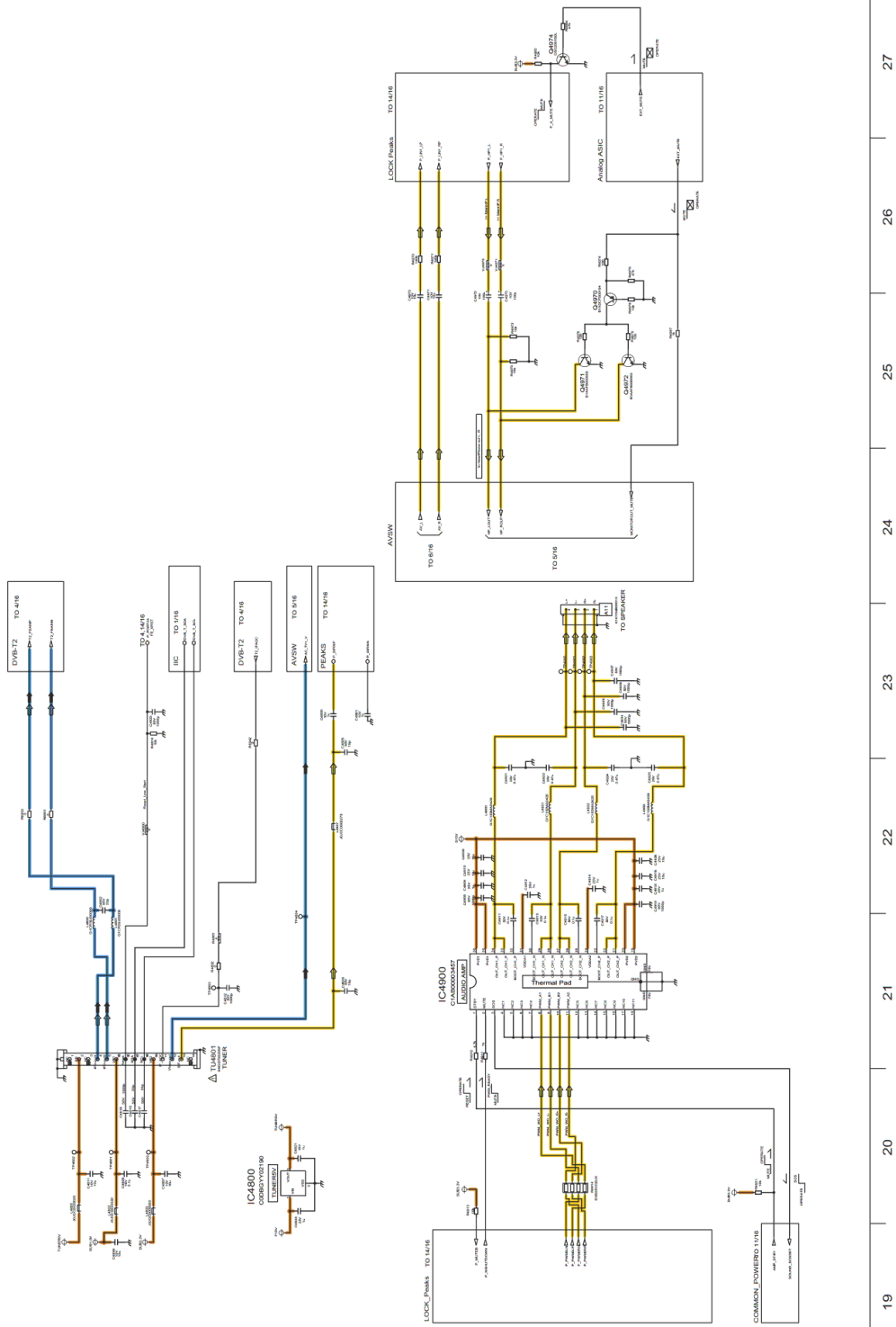

Model No. : TX-P42UT30B/Y A-Board (4/16)

A-BOARD (4/16) TERMINAL

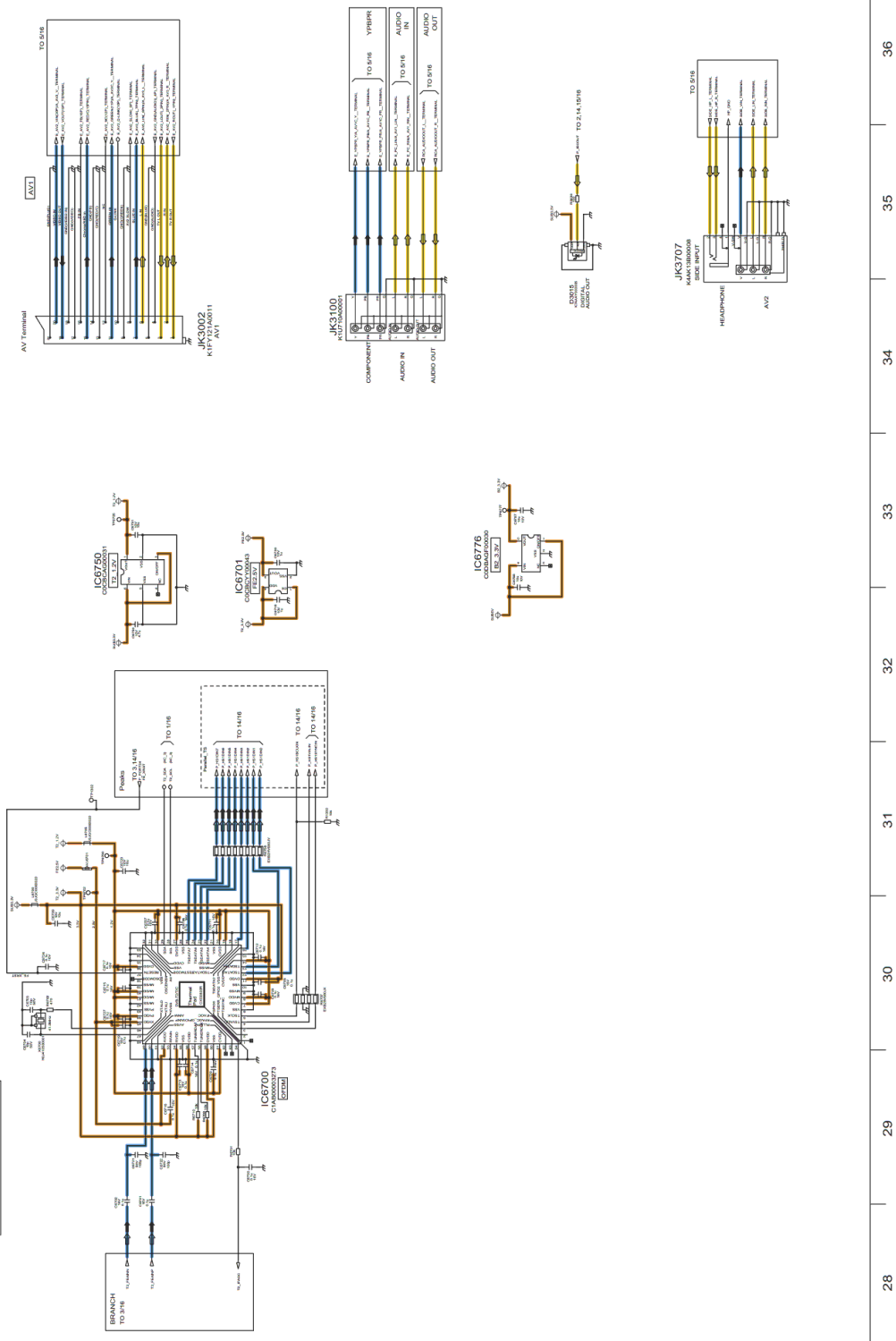

28 29 30 31 32 33 34 35 36

A-BOARD (5/16) AVSW-CONNECTION

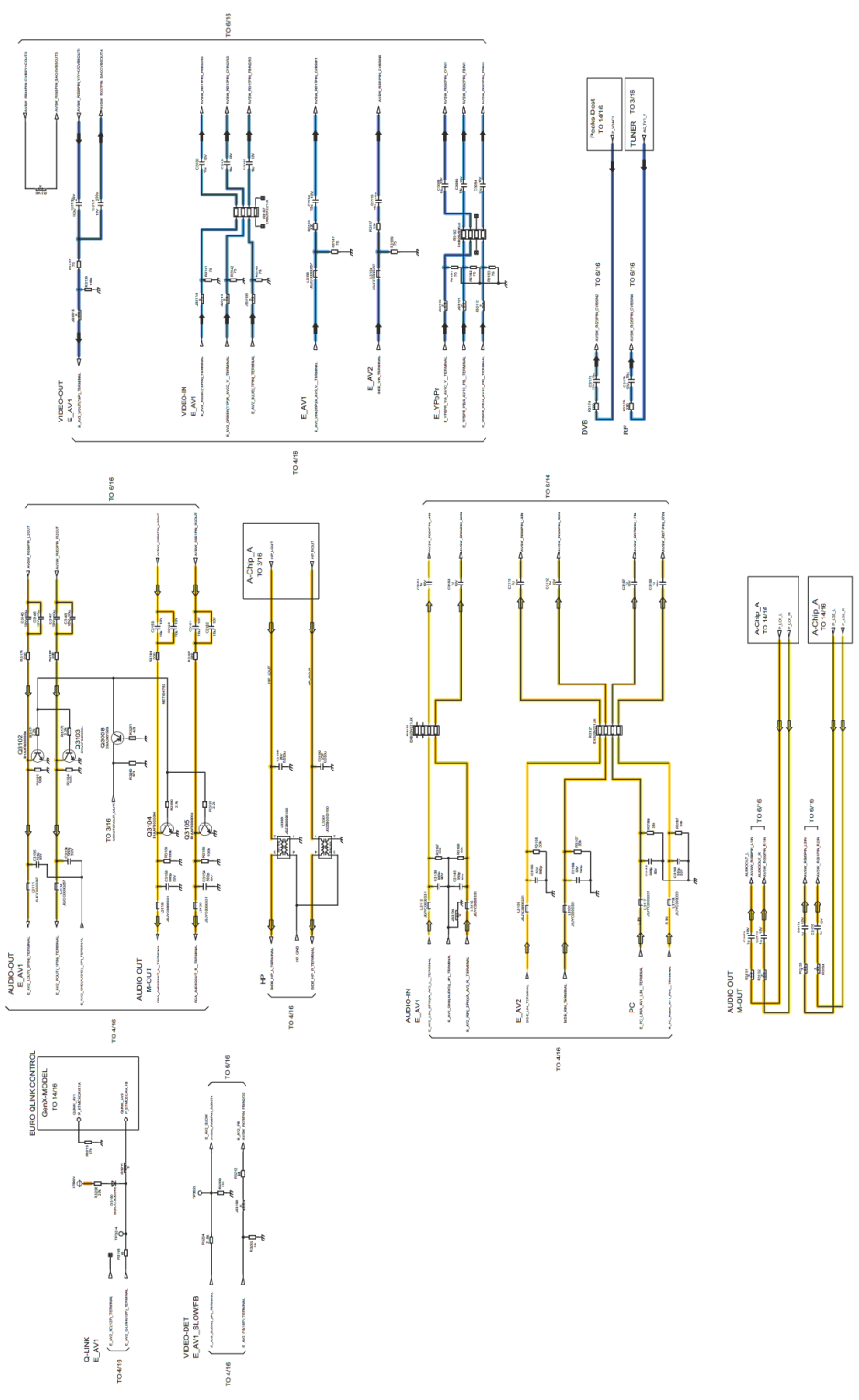

37 38 39 40 41 42 43 44 45

△ A-BOARD (6/16) AV SW

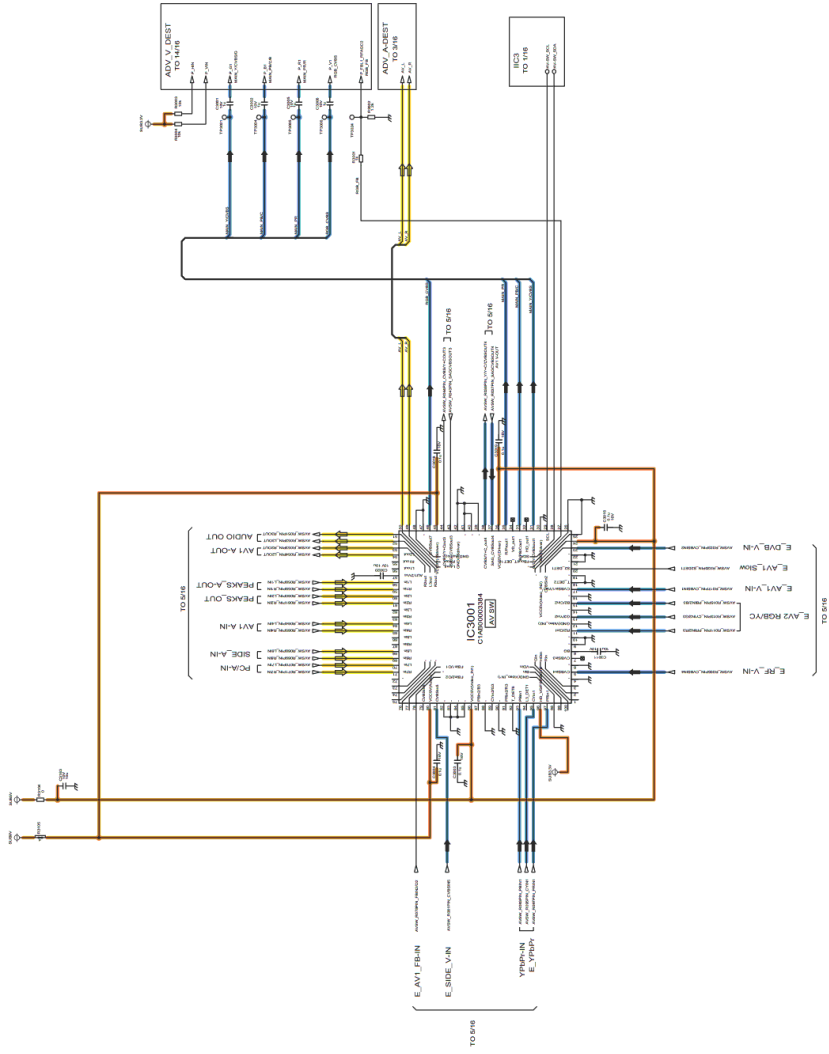

46 47 48 49 50 51 52 53 54

△ A-BOARD (7/16) CI SLOT

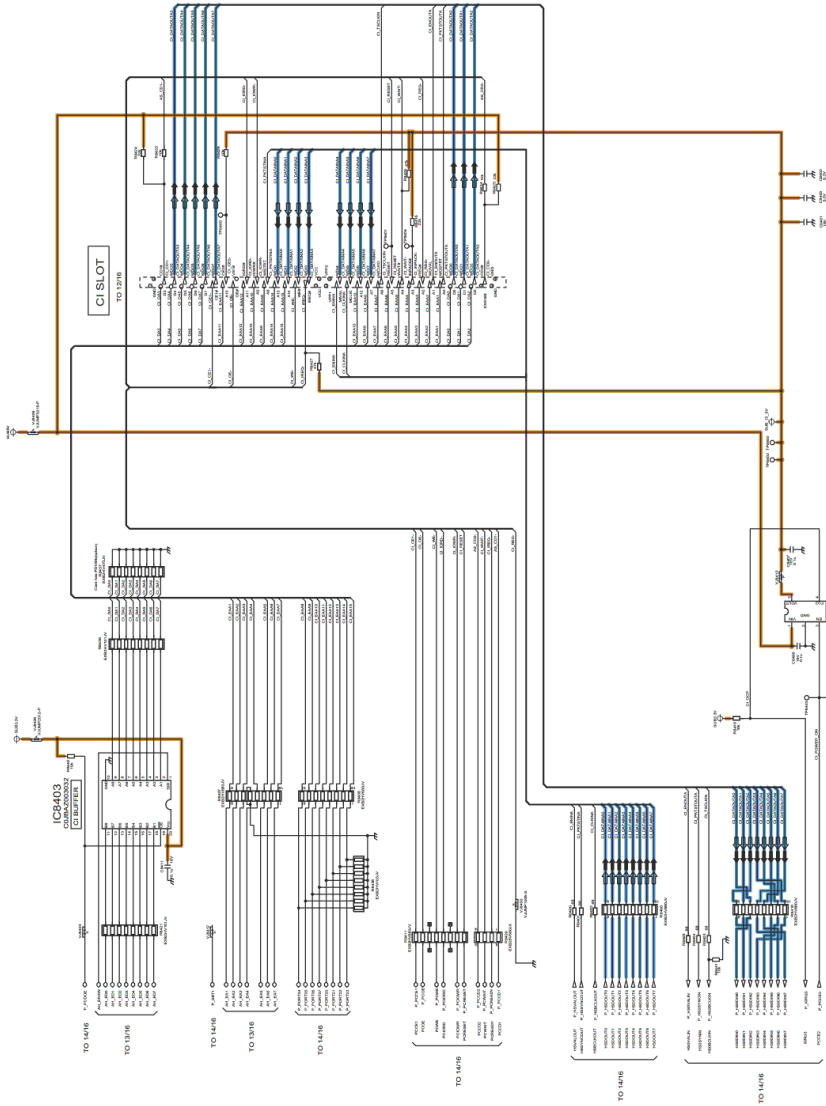

55 56 57 58 59 60 61 62 63

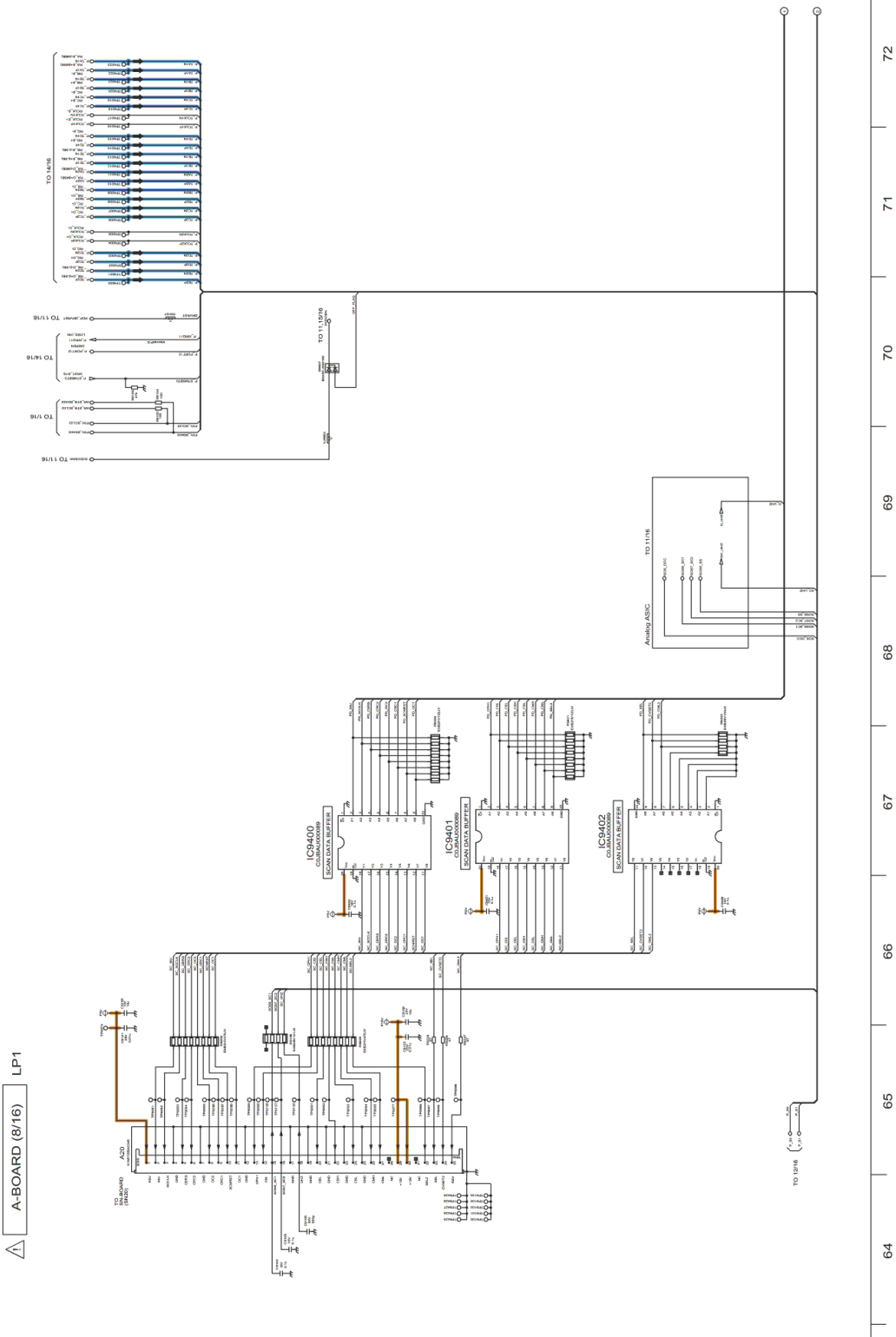

64 65 66 67 68 69 70 71 72

△ A-BOARD (8/16) LP1

Model No. : TX-P42UT30B/Y A-Board (9/16)

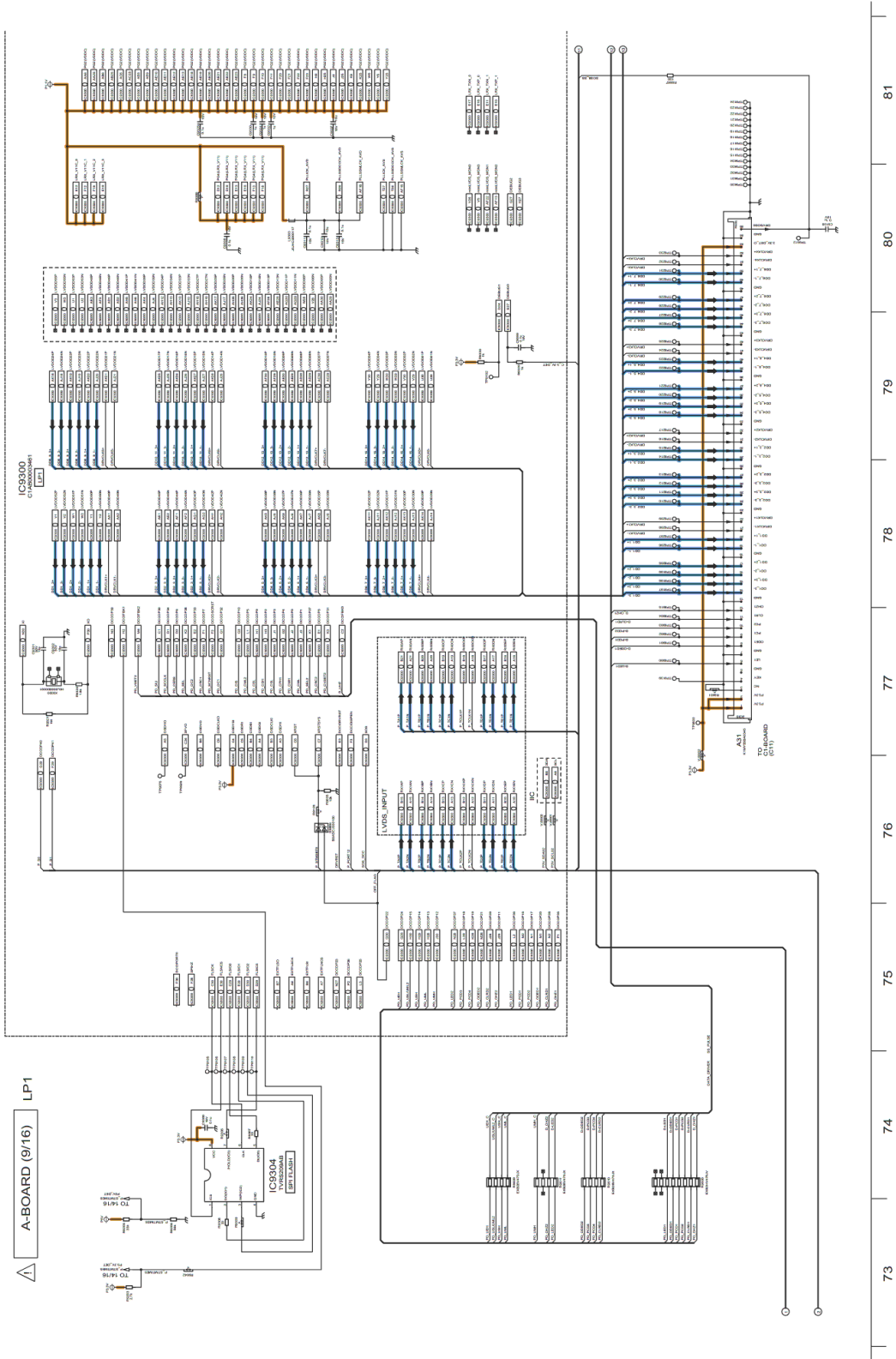

73 74 75 76 77 78 79 80 81

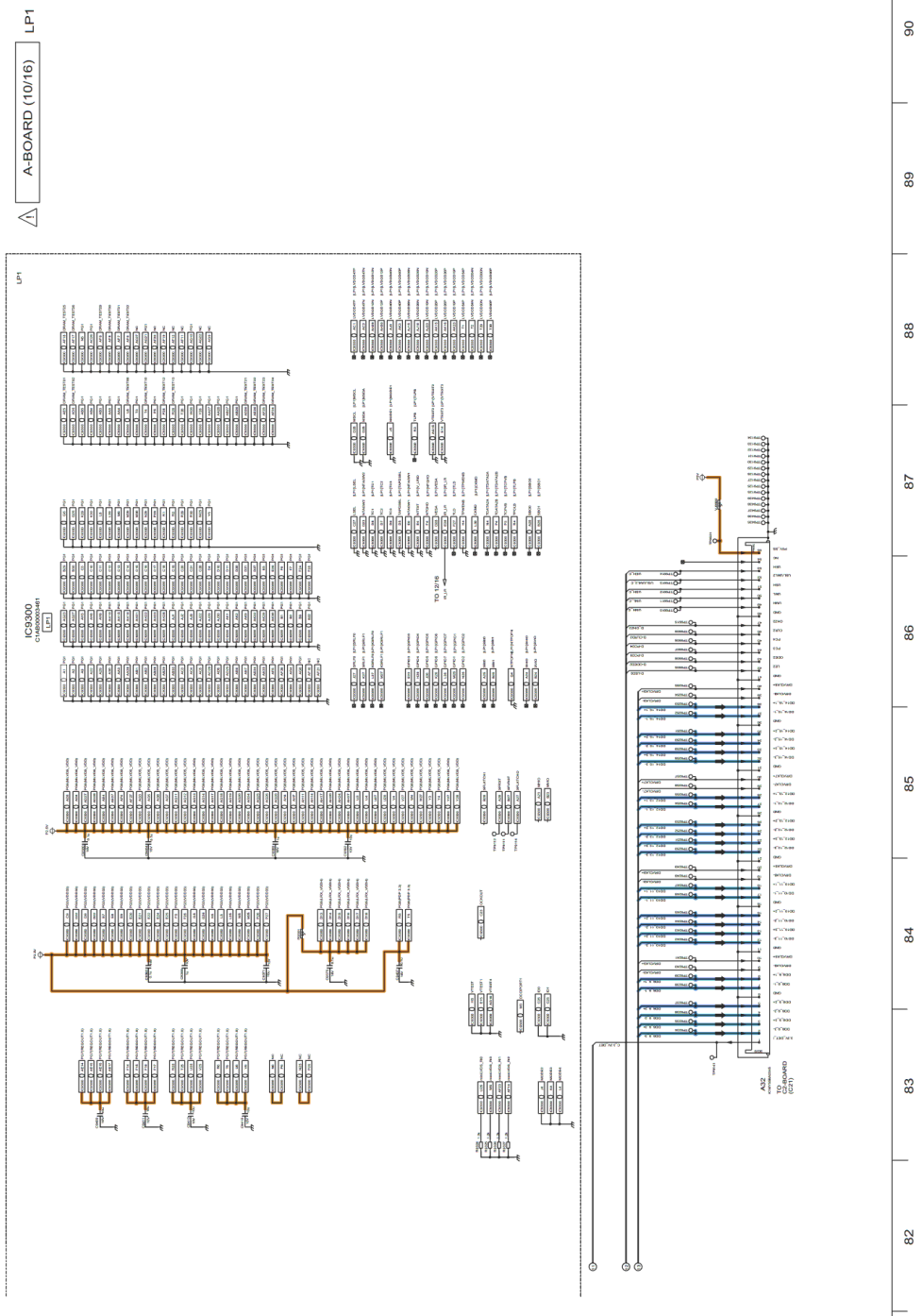

△ A-BOARD (11/16) POWER

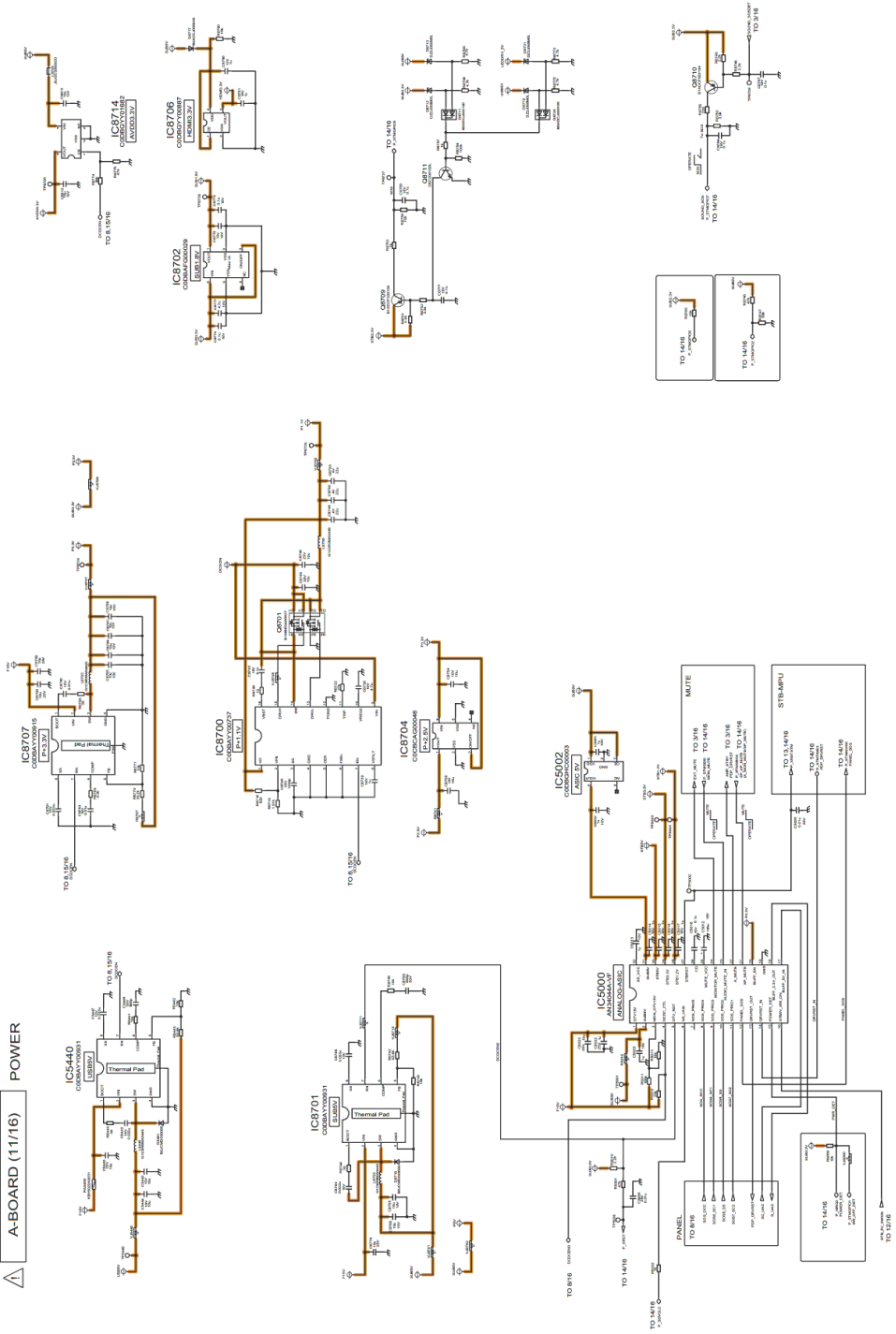

Model No. : TX-P42UT30B/Y A-Board (12/16), K and V-Board

△ A-BOARD (12/16) CI SLOT, CONNECTOR

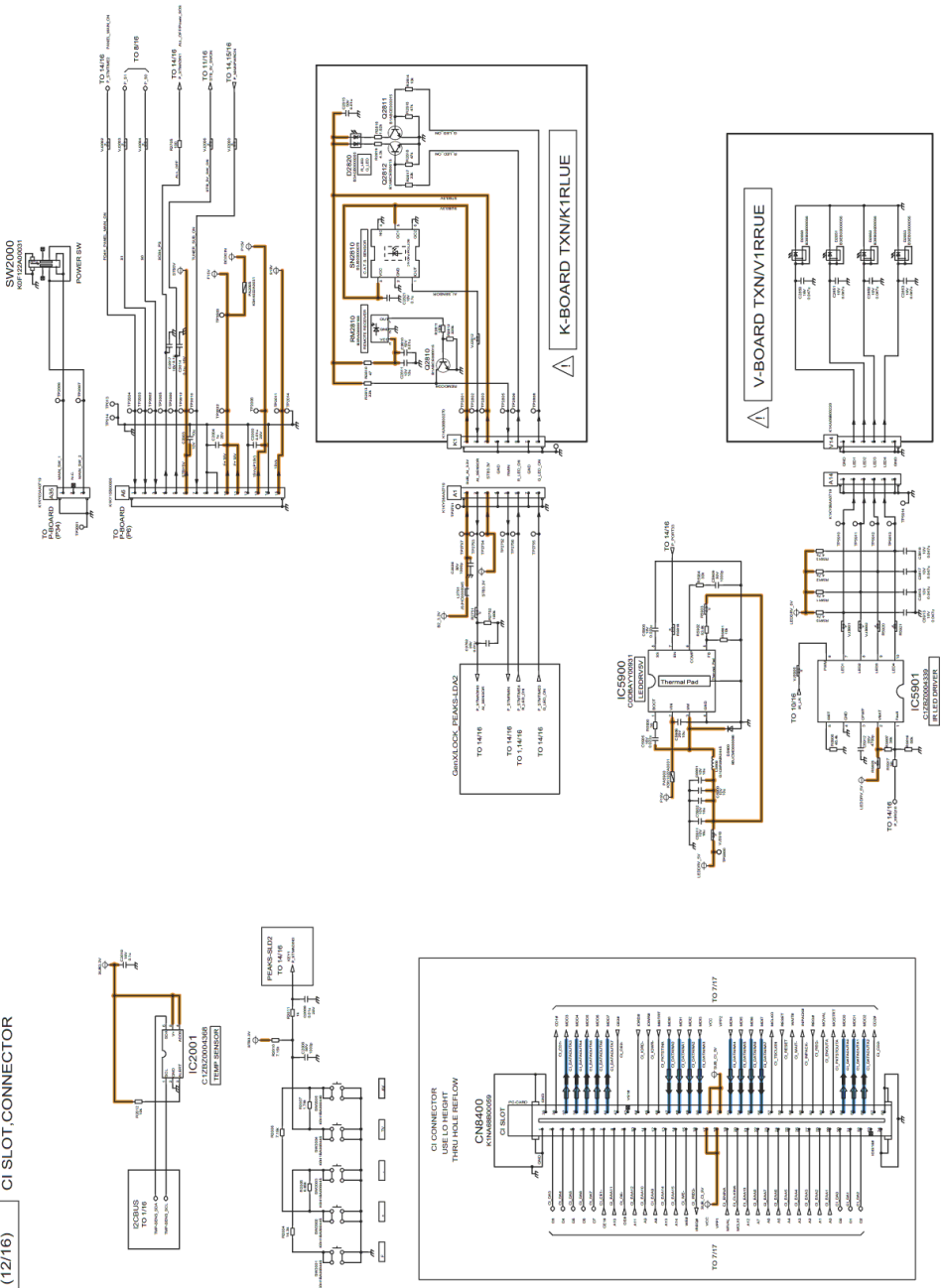

100 101 102 103 104 105 106 107 108

A-BOARD (15/16) PEAKS POWER

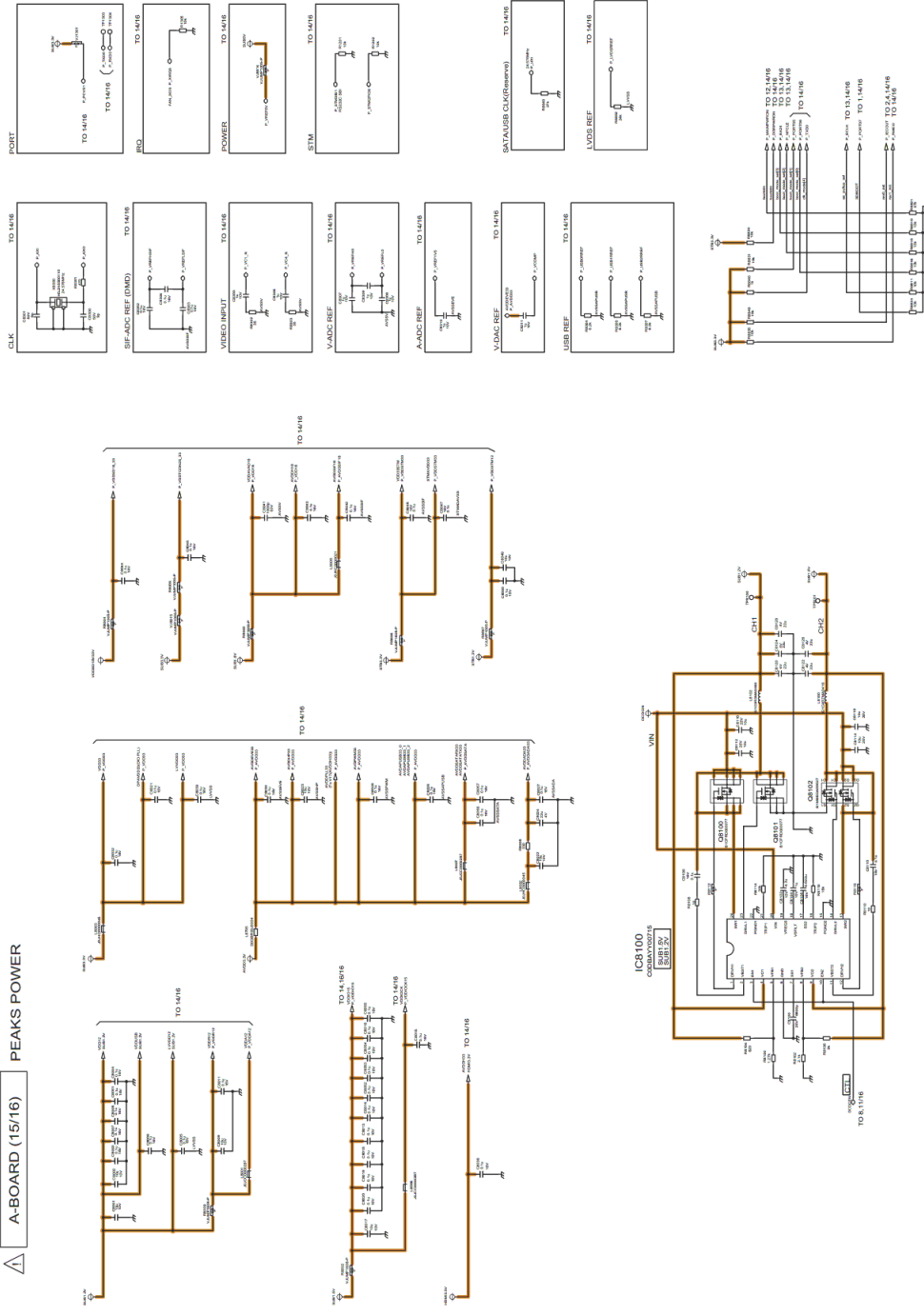

127 128 129 130 131 132 133 134 135

△ A-BOARD (16/16) DDR3

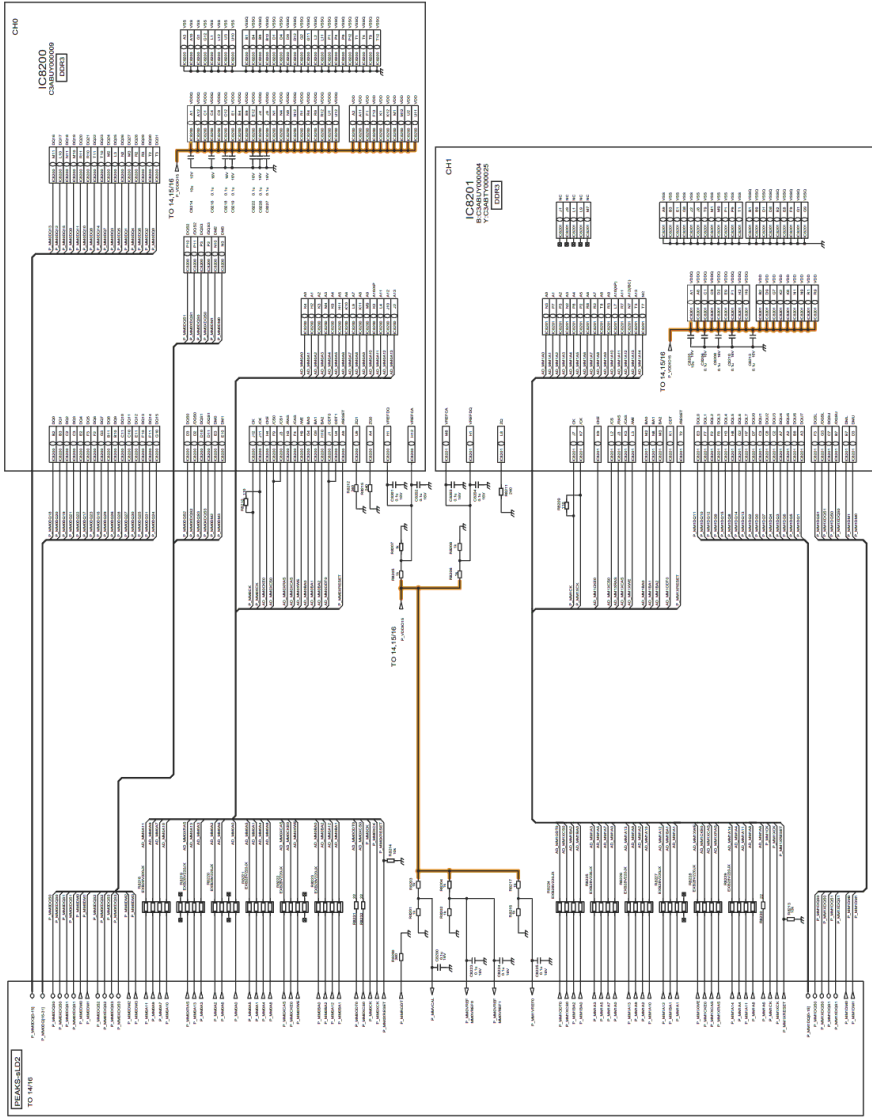

136 137 138 139 140 141 142 143 144

Model No. : TX-P42UT30B/Y C1-Board (1/2)

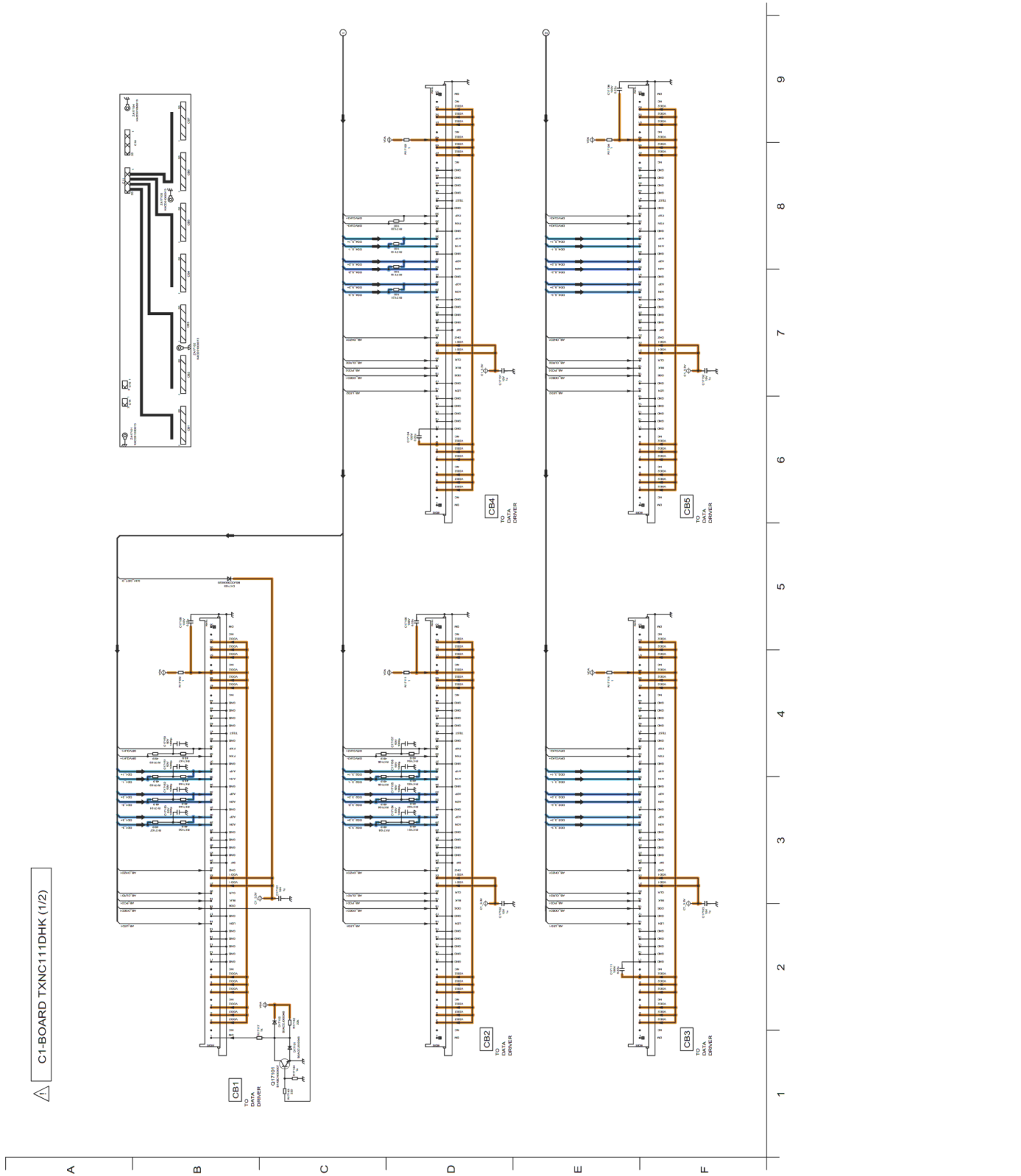

Model No. : TX-P42UT30B/Y C1-Board (2/2)

△ C1-BOARD TXNC111DHK (2/2)

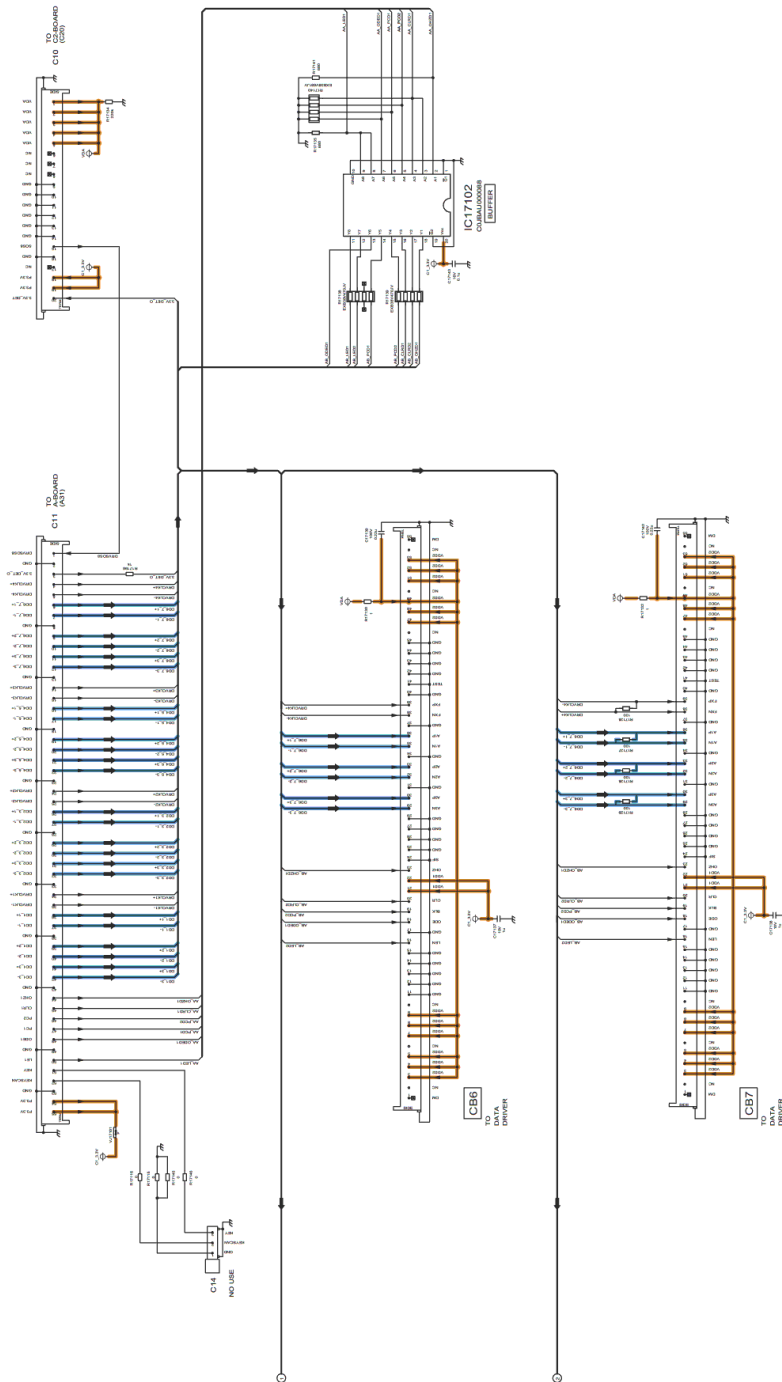

Model No. : TX-P42UT30B/Y C2-Board (1/2)

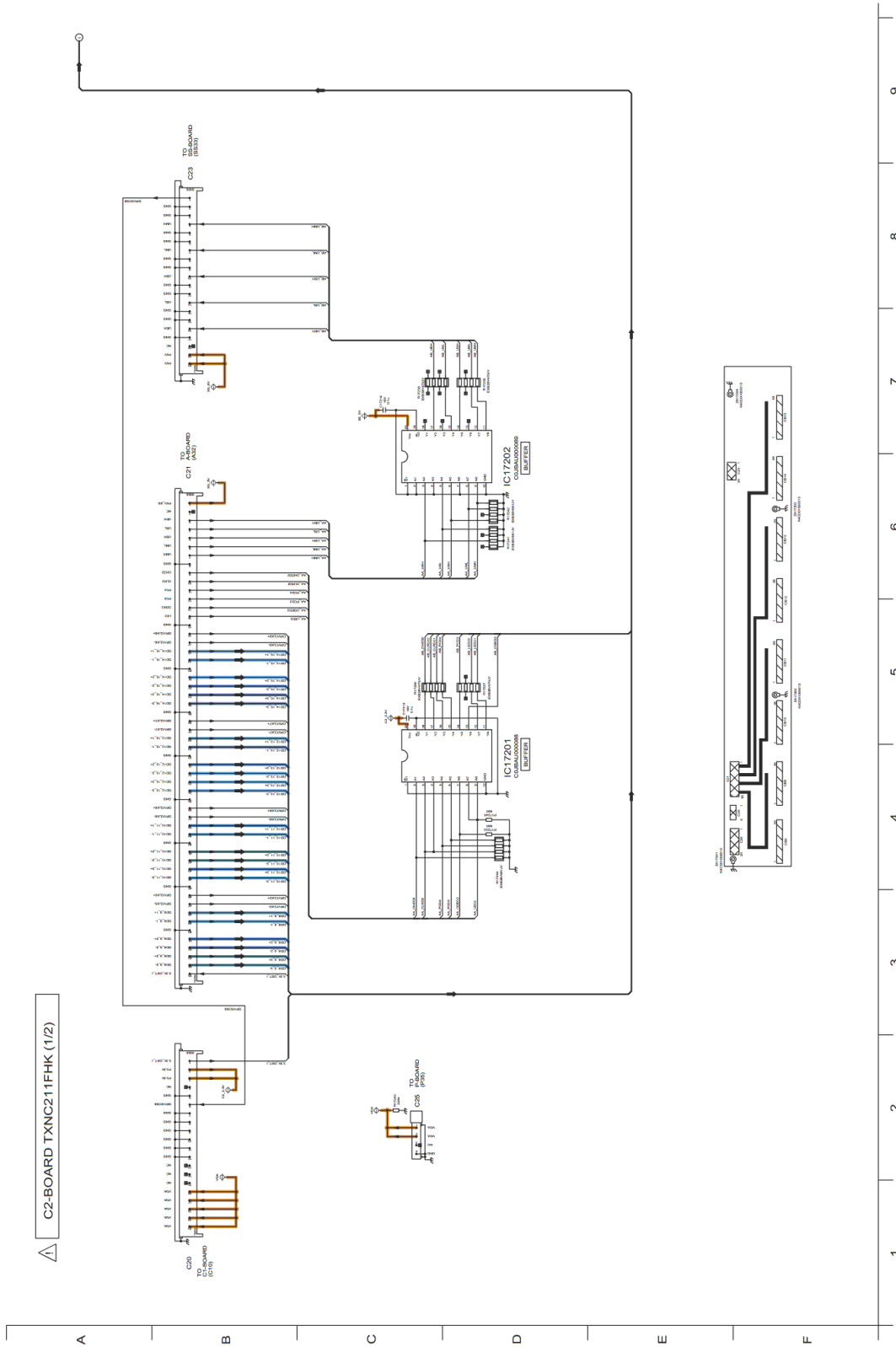

Model No. : TX-P42UT30B/Y C2-Board (2/2)

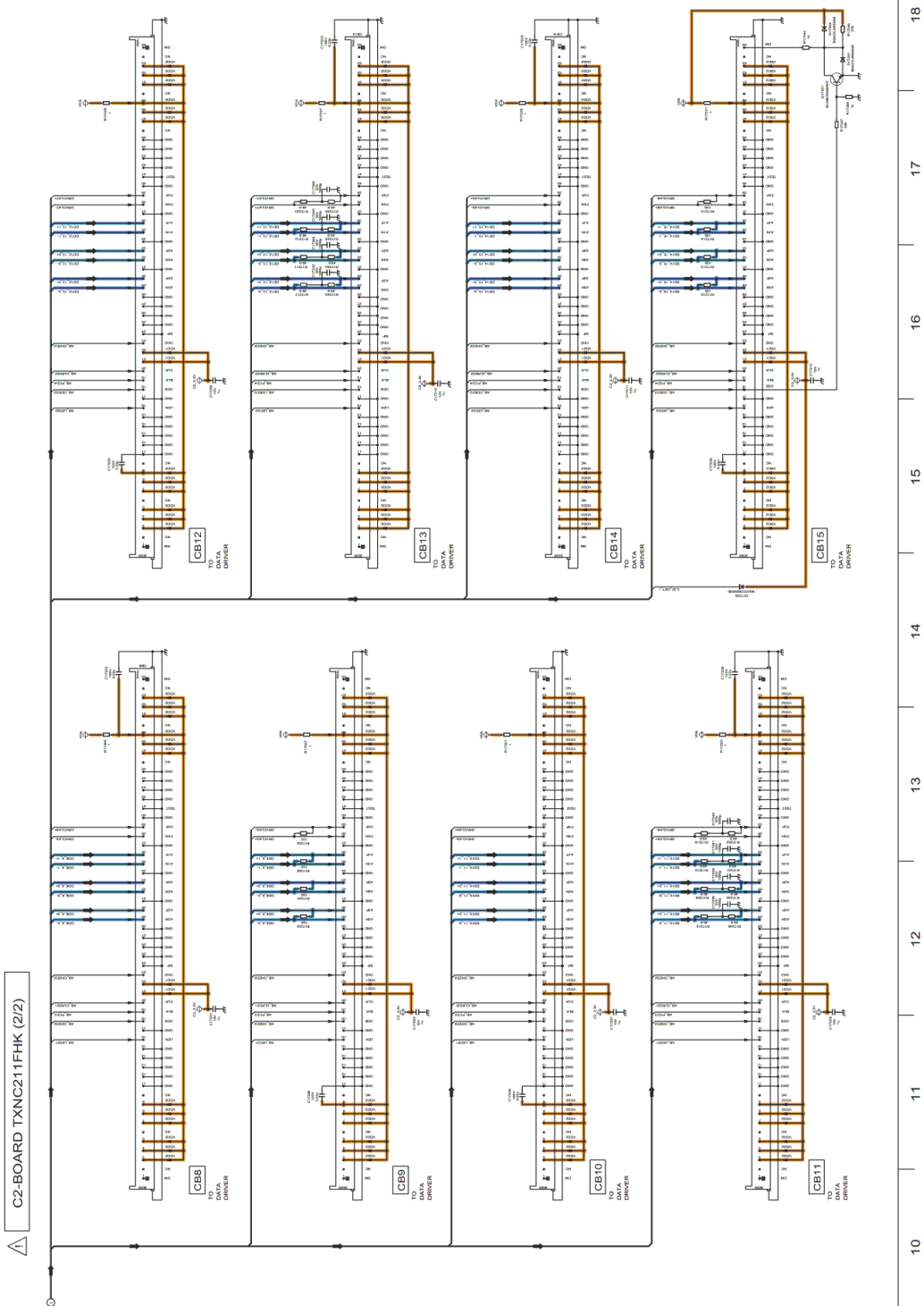

△ SN-BOARD TXNSN11FHK (1/6)

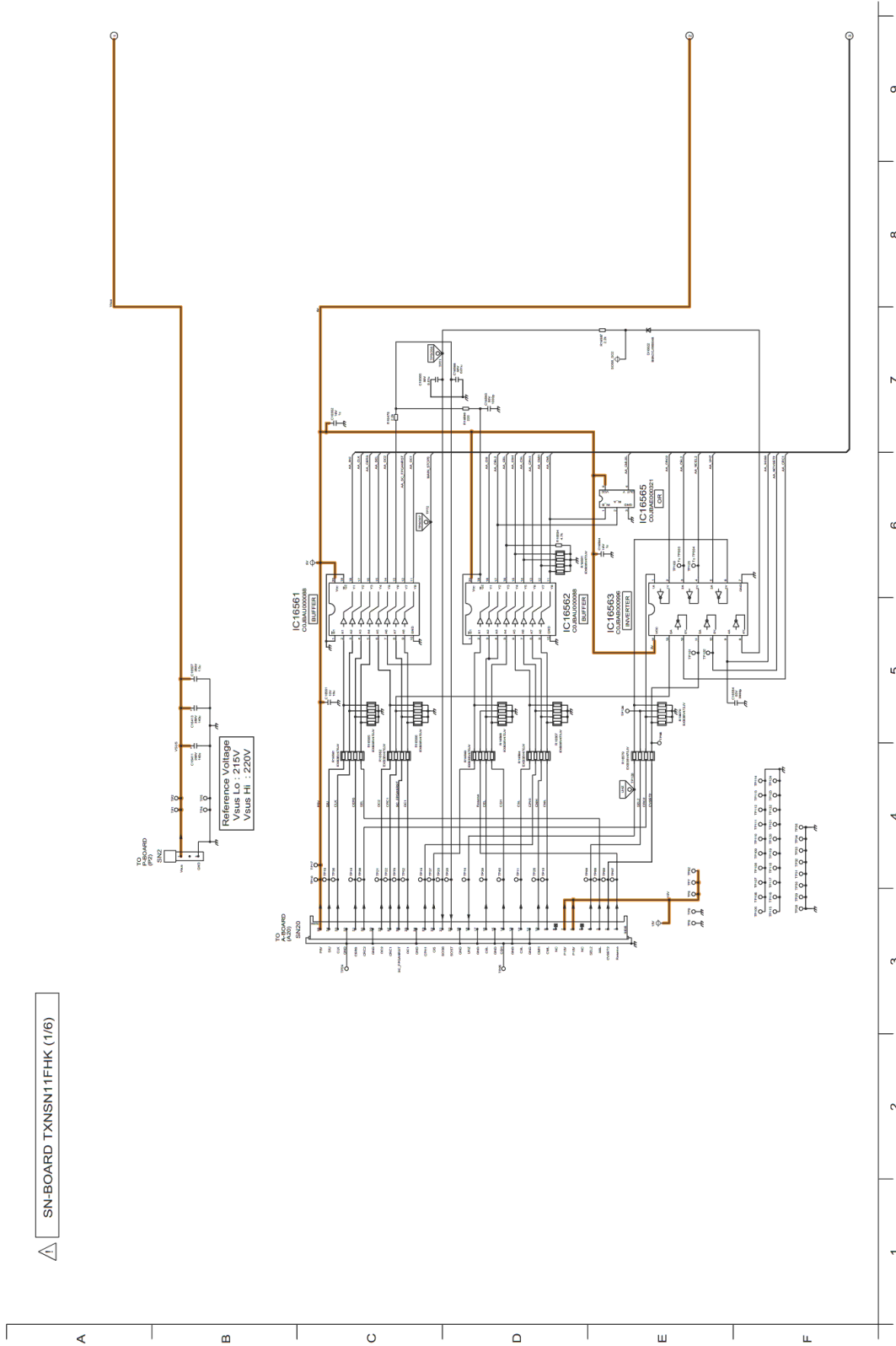
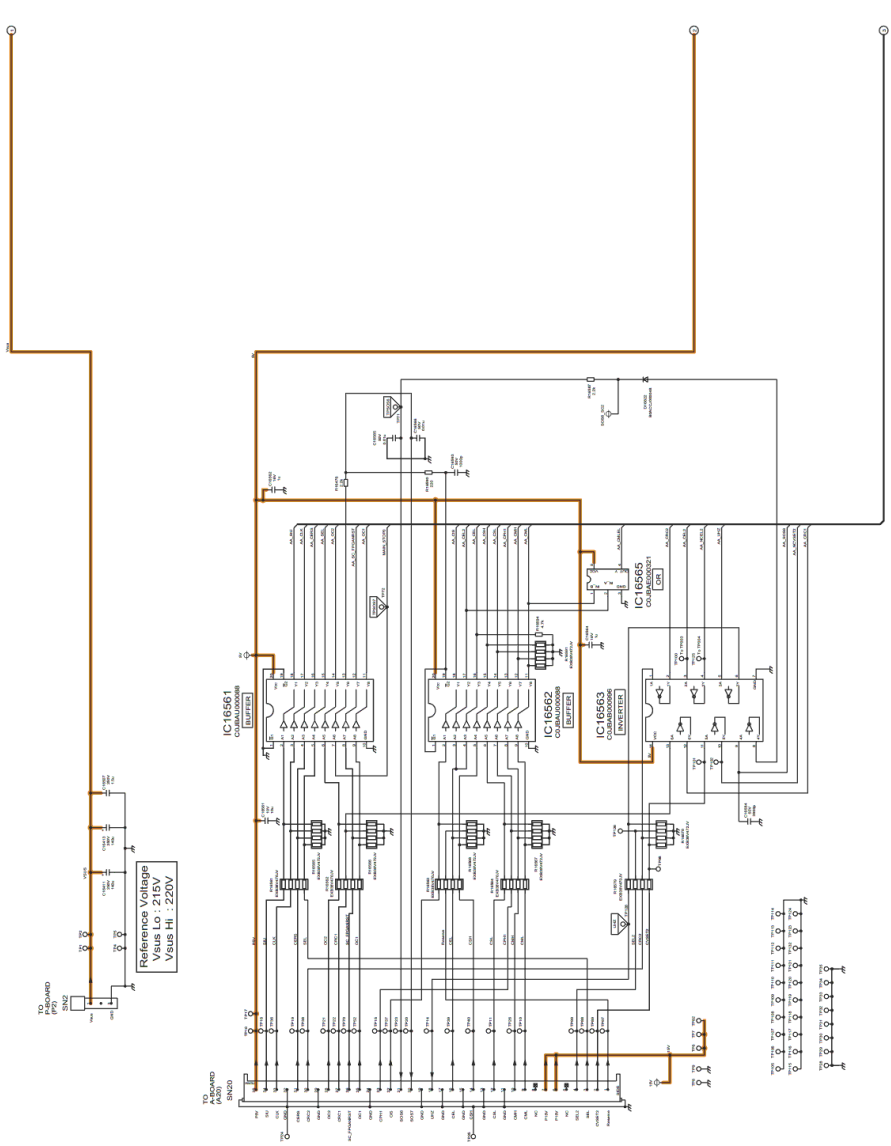

△ SN-BOARD TXNSN11FHK (2/6)

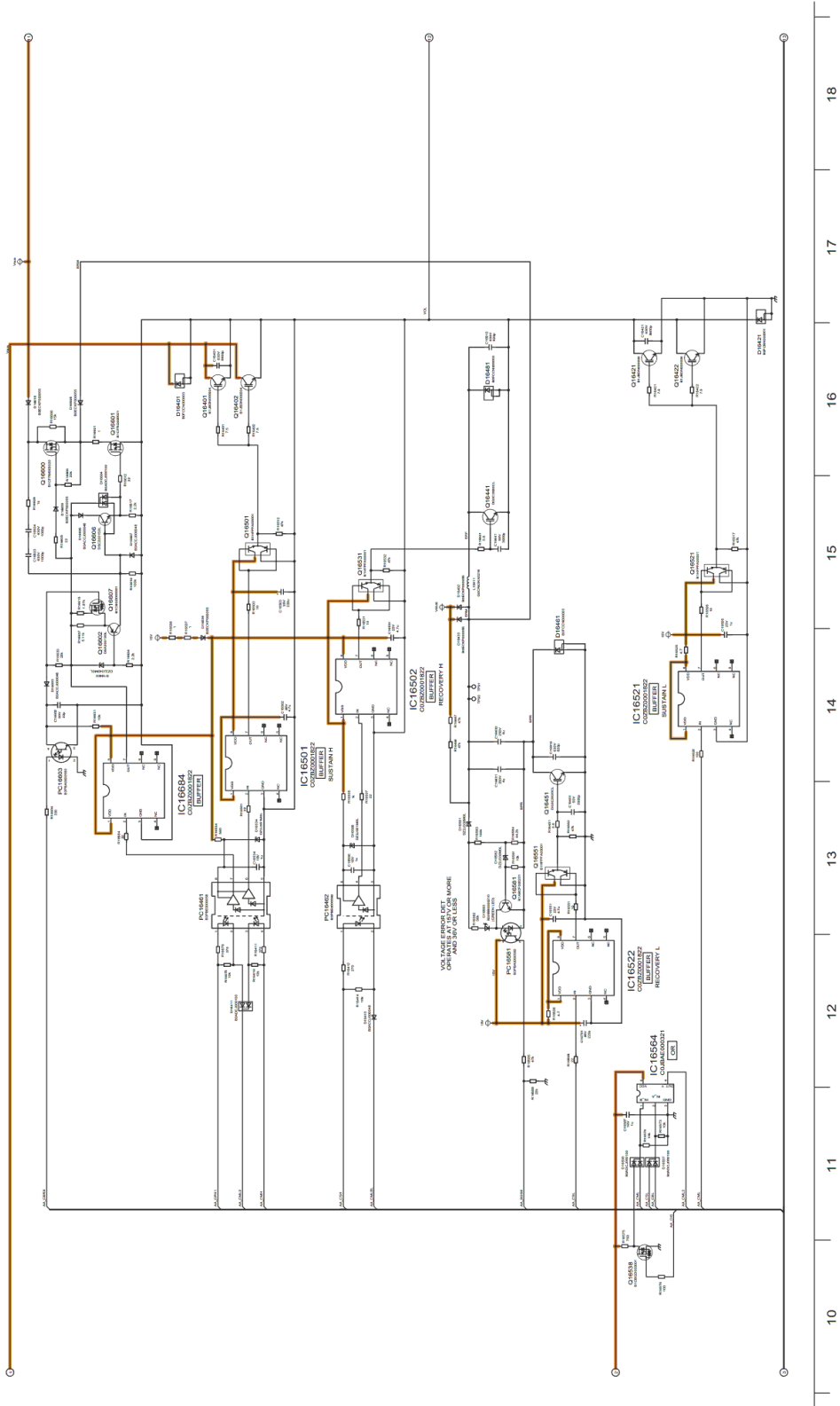

△ SN-BOARD TXNSN11FHK (3/6)

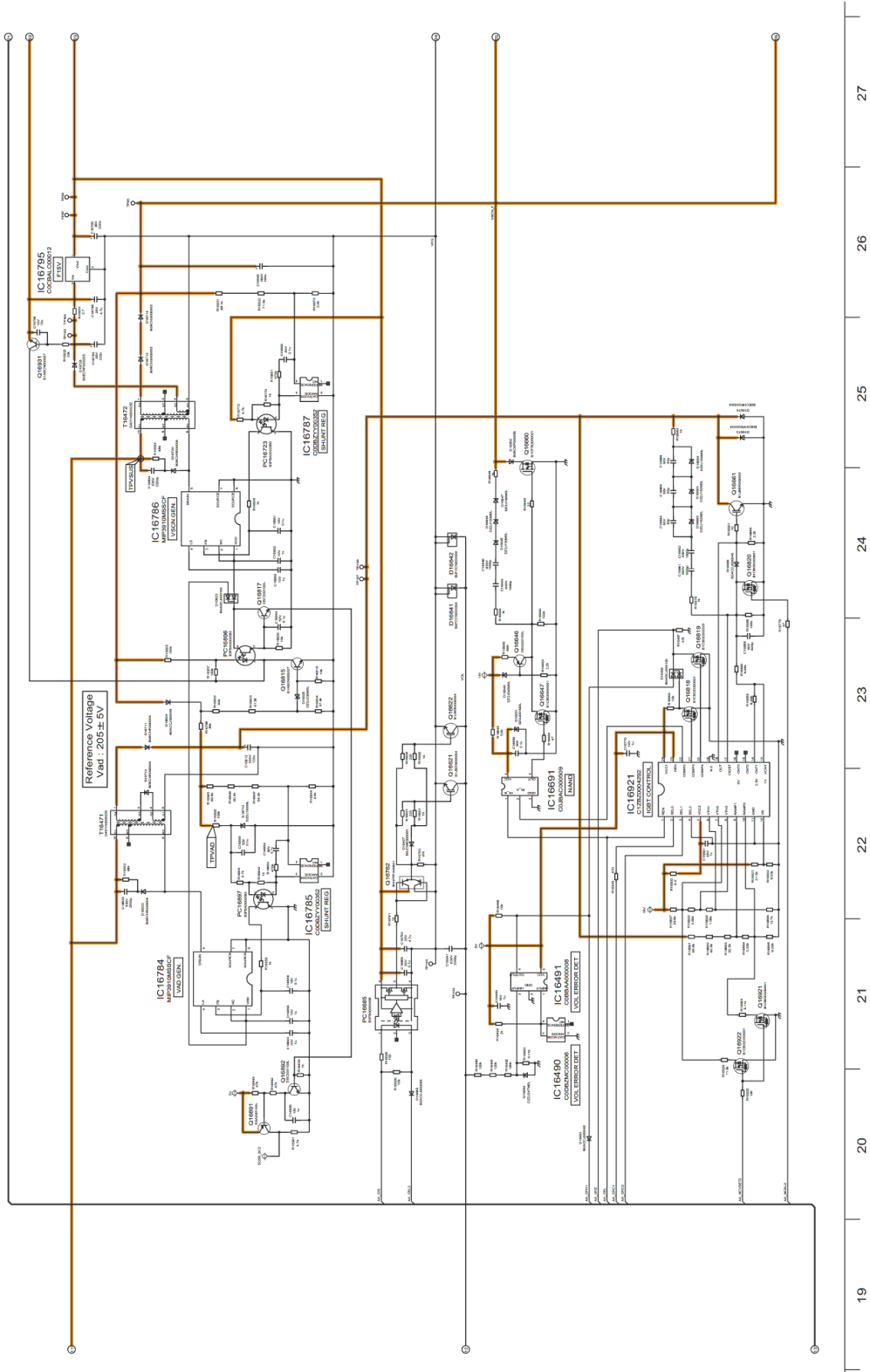

19 20 21 22 23 24 25 26 27

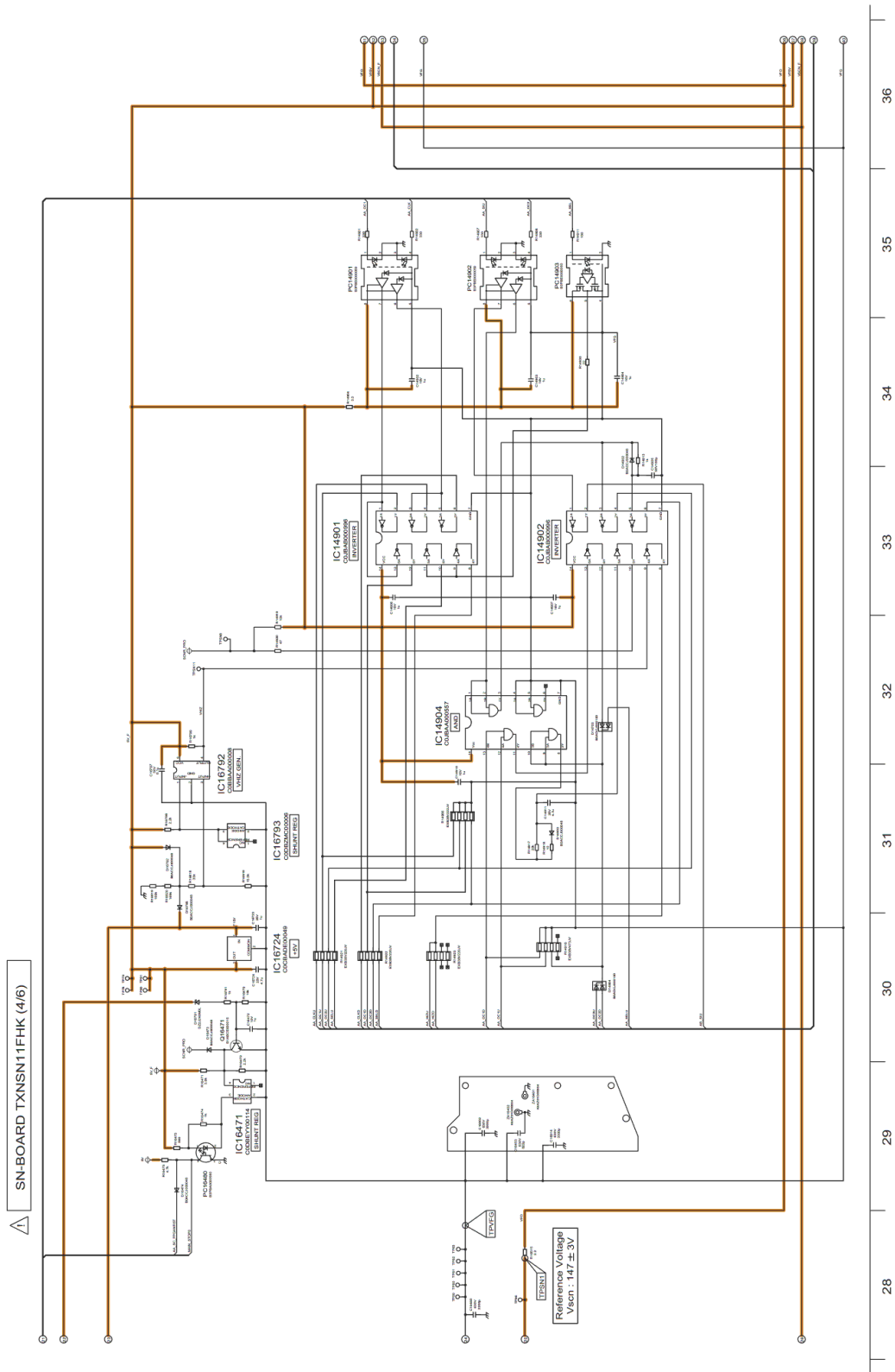

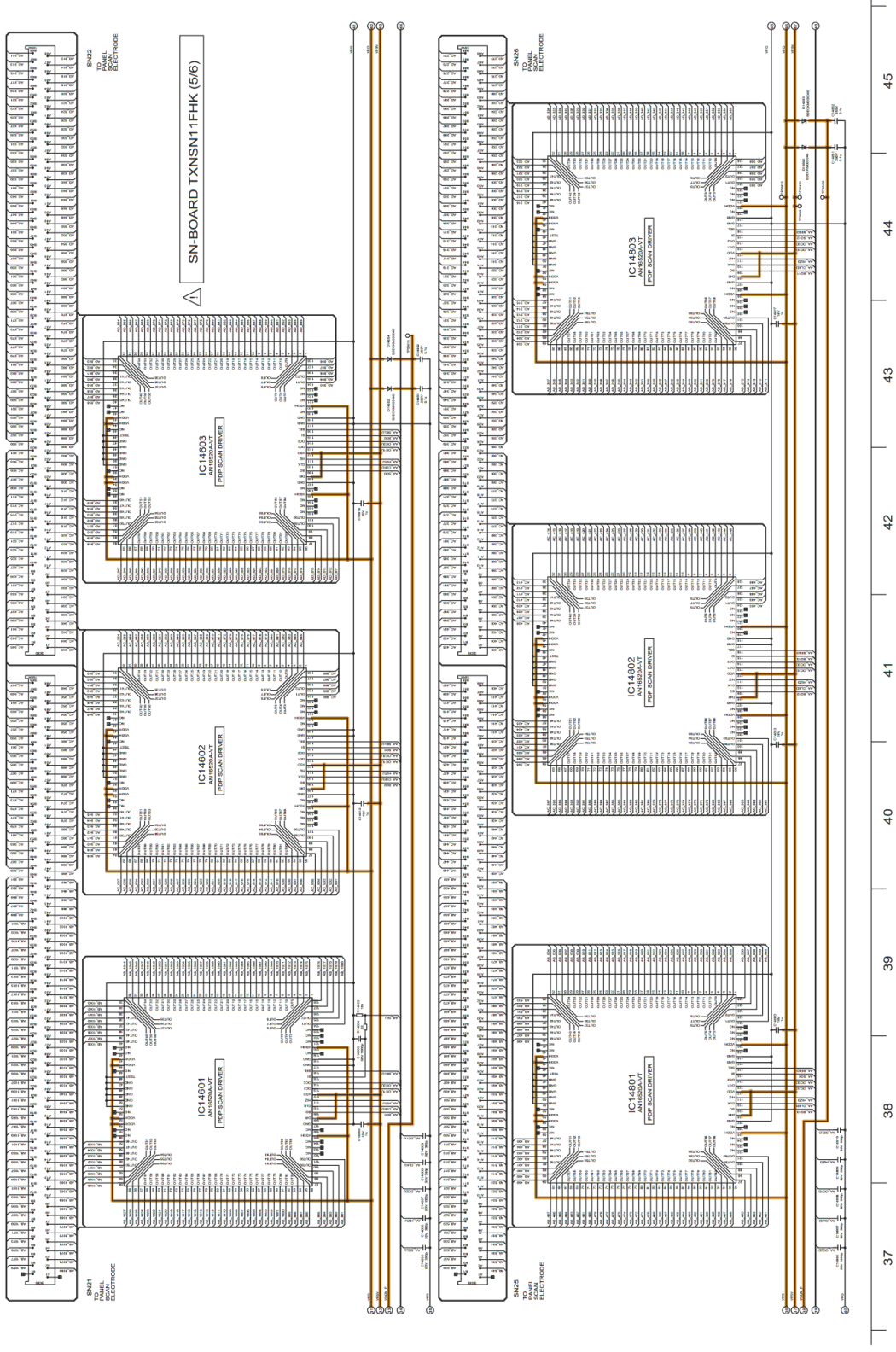

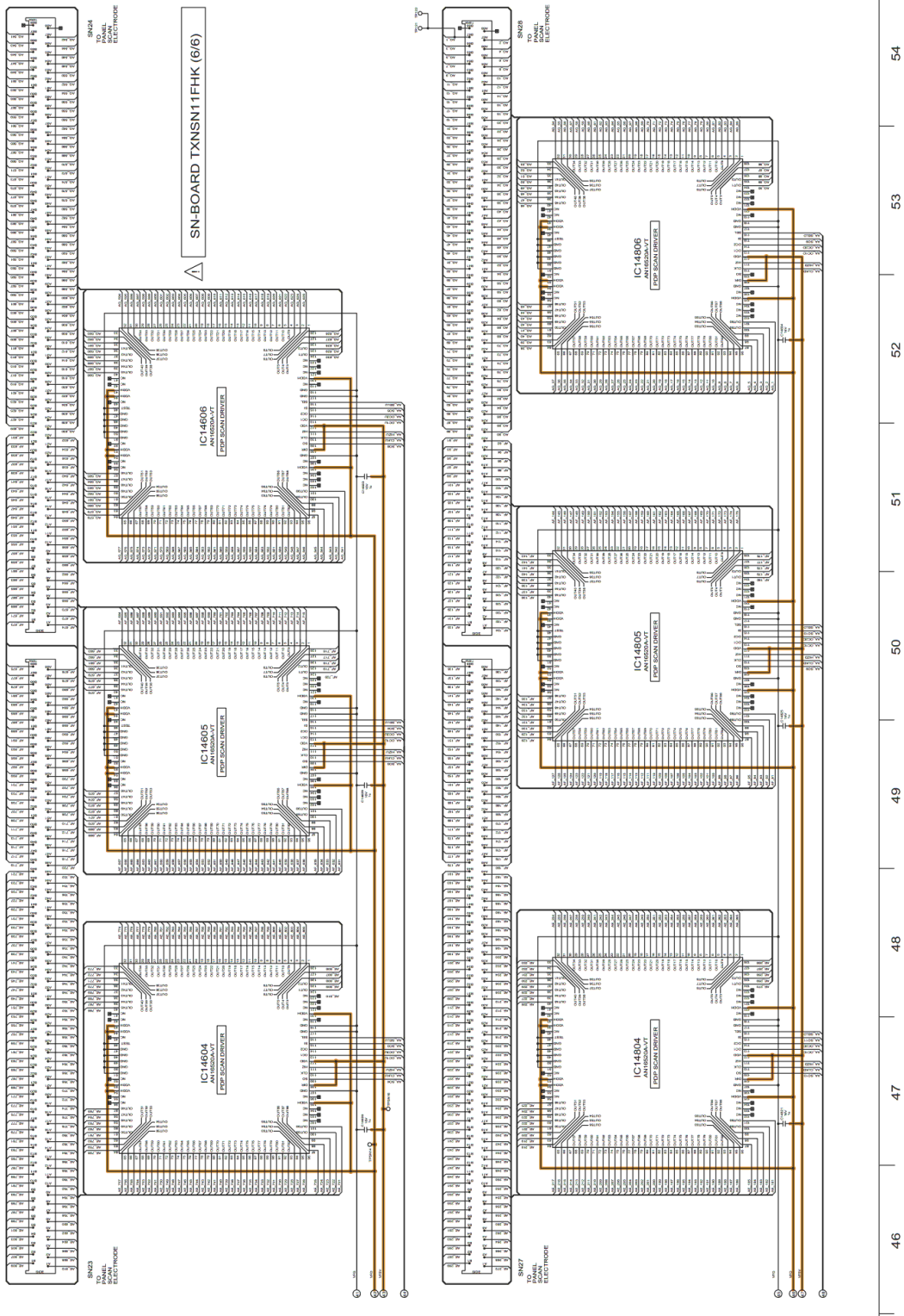

Model No. : TX-P42UT30B/Y SS-Board (1/2)

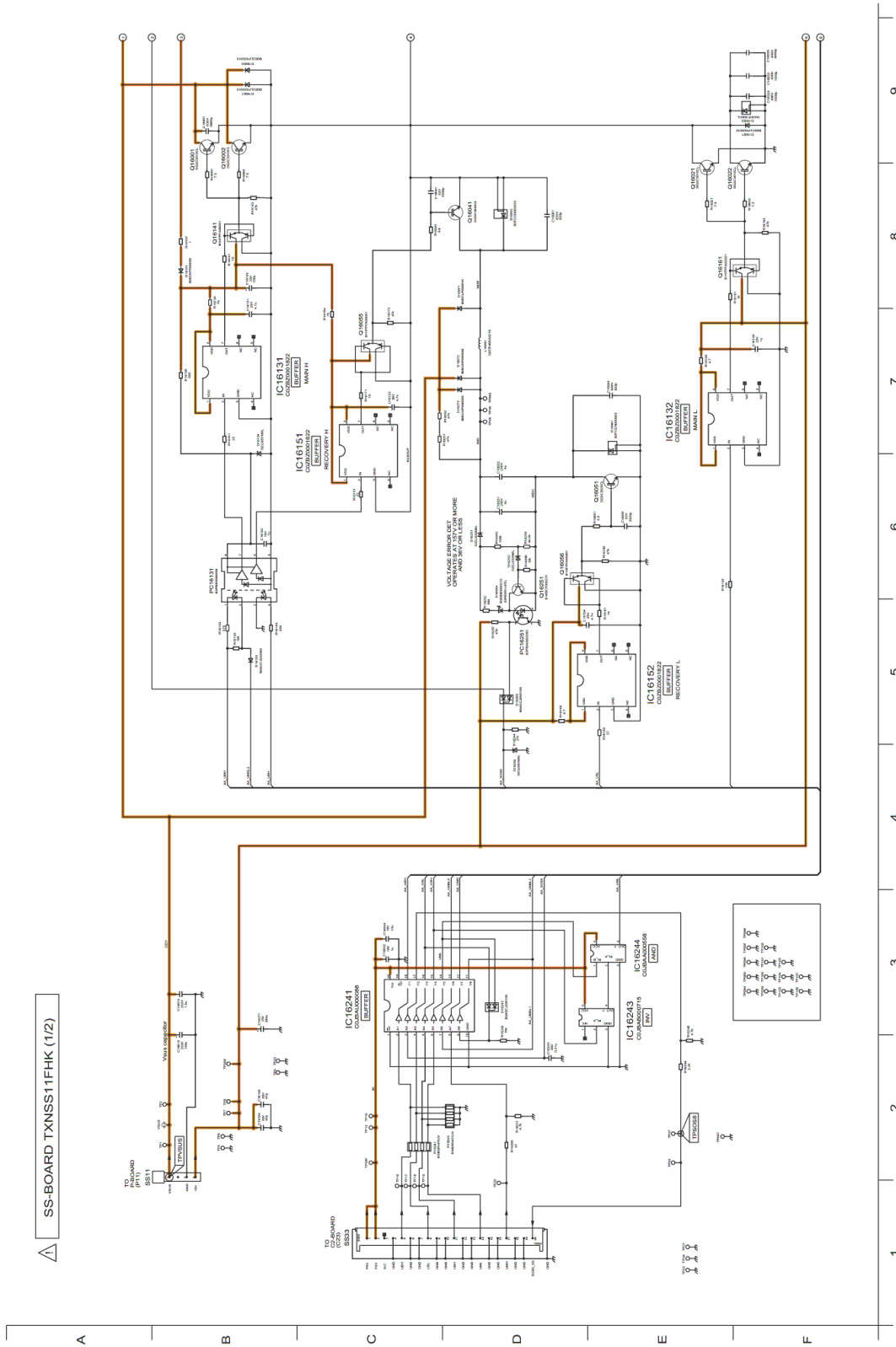

Model No. : TX-P42UT30B/Y SS-Board (2/2)

△ SS-BOARD TXNSS11FHK (2/2)

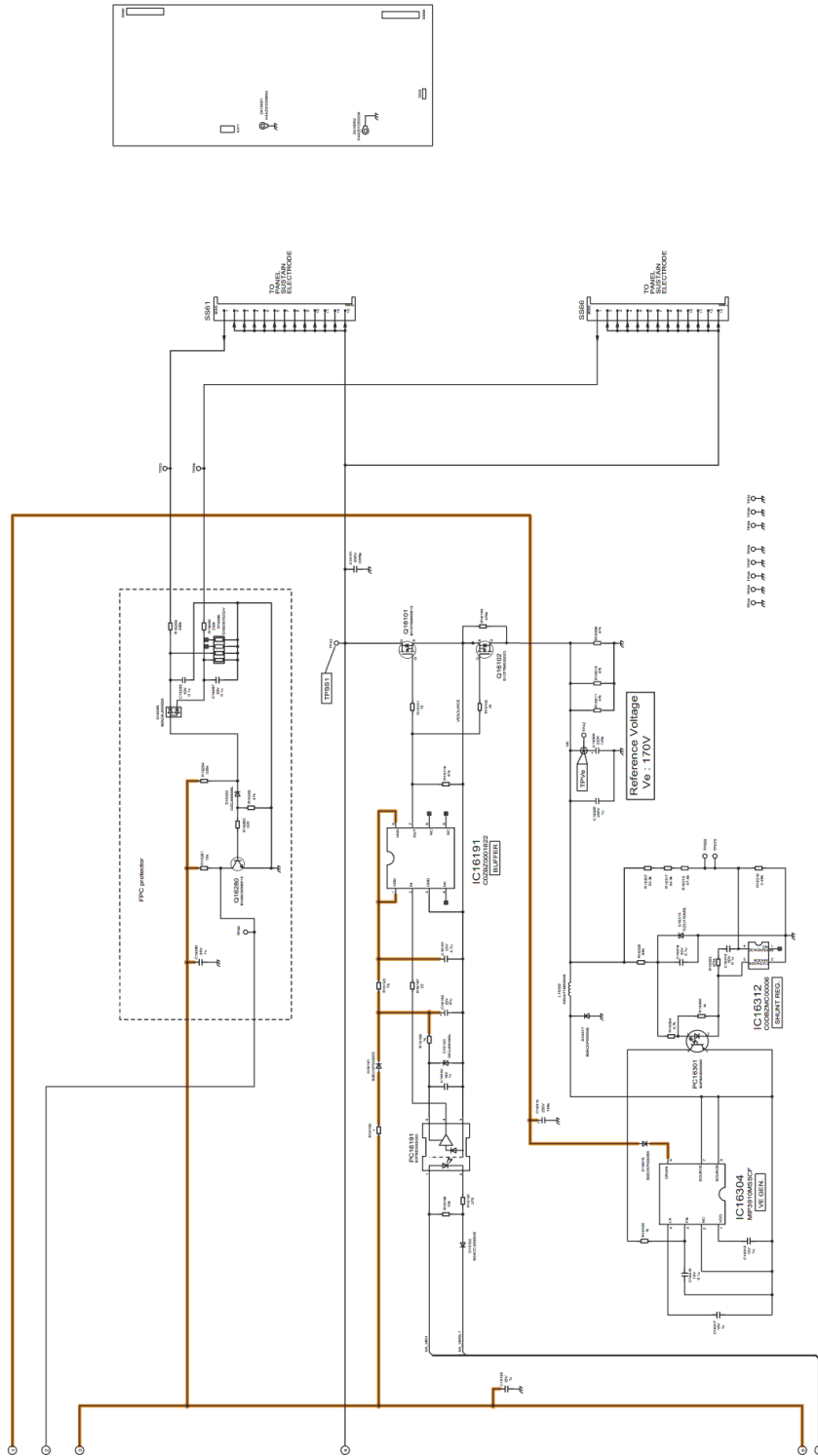

18
17
16
15
14
13
12
11
10

Model No. : TX-P42UT30B/Y A-Board (Foil side)

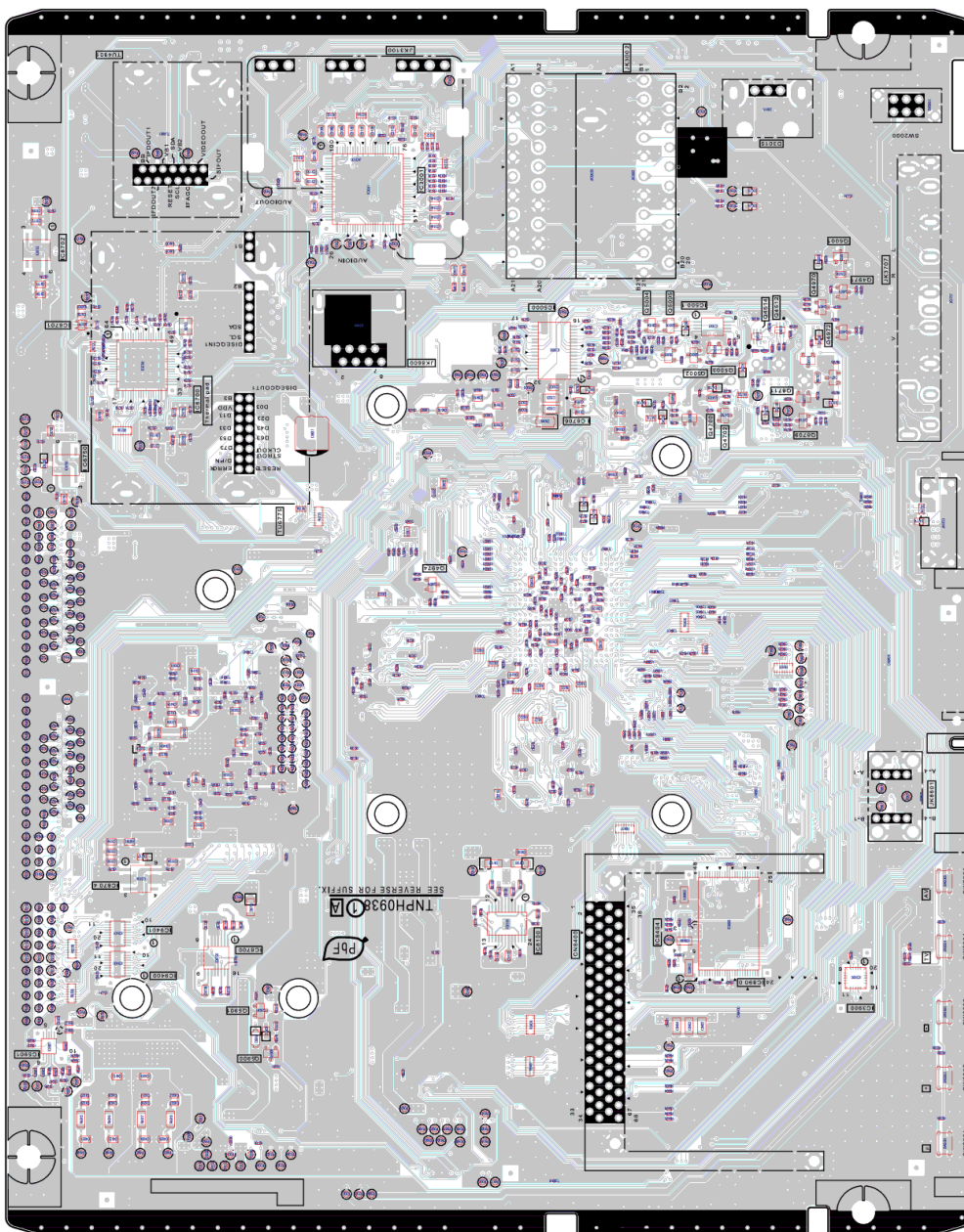

Model No. : TX-P42UT30B/Y A-Board (Component side)

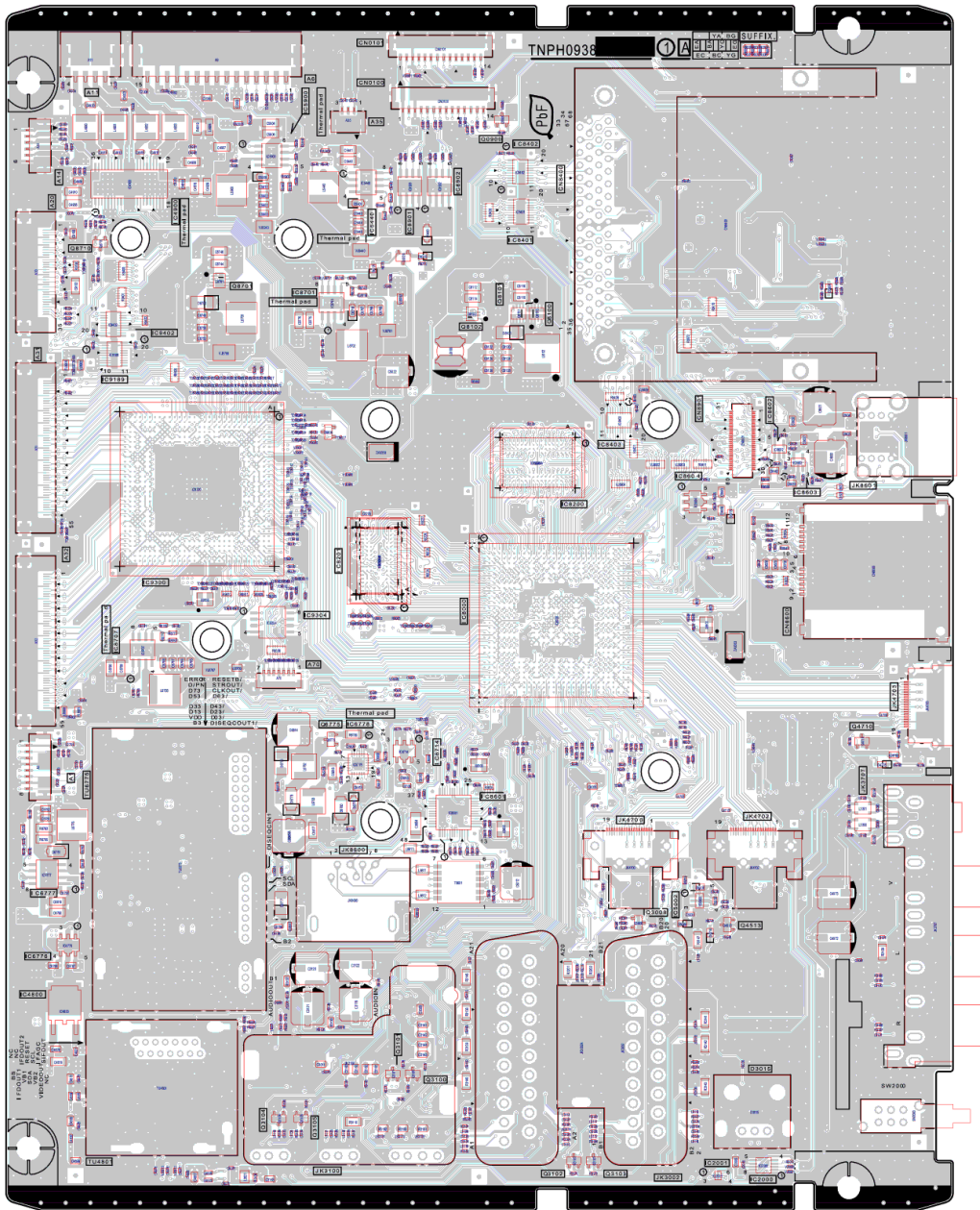

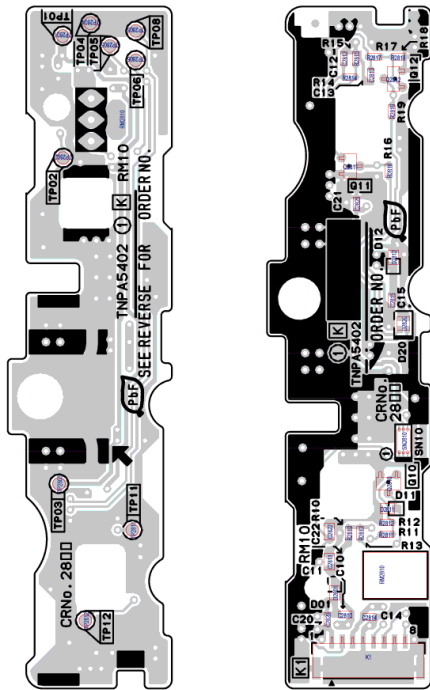
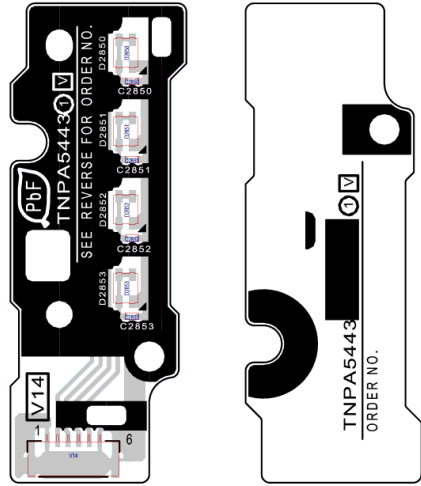

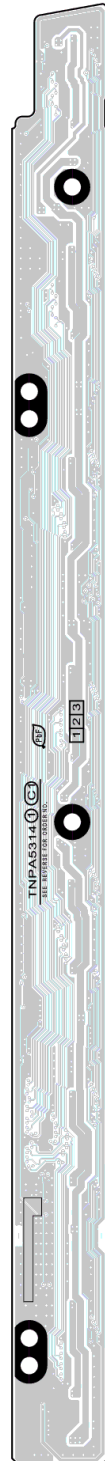

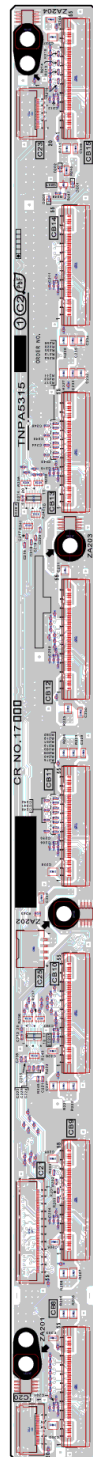
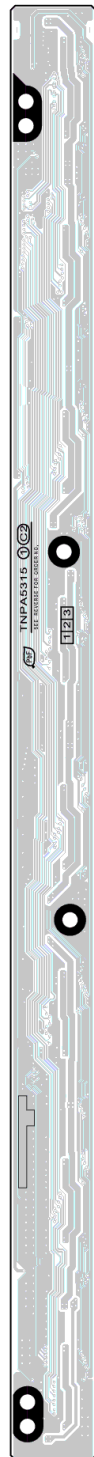

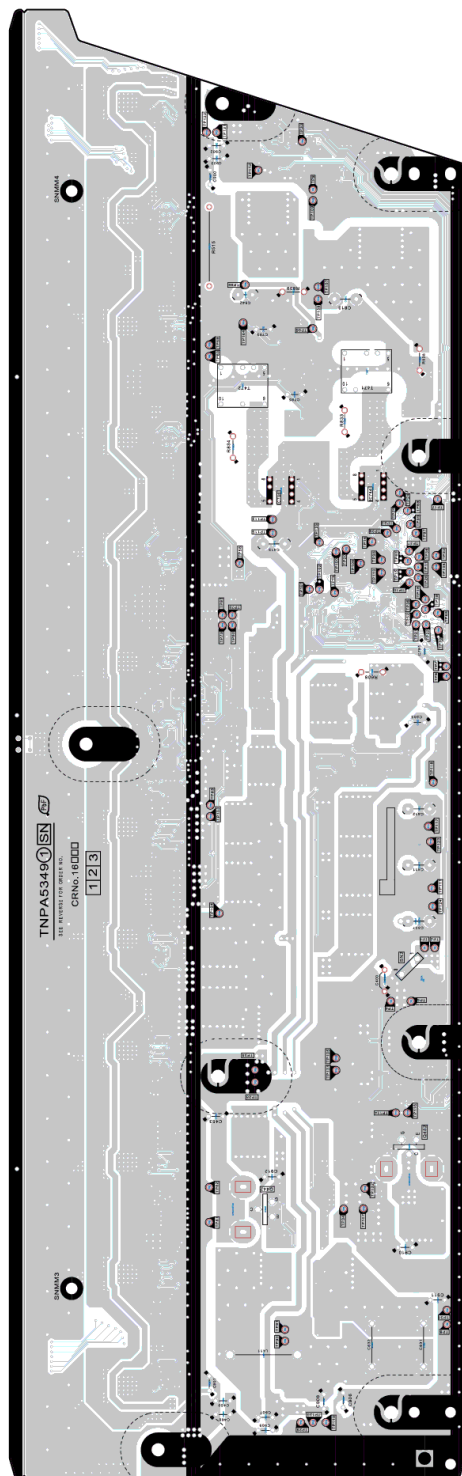

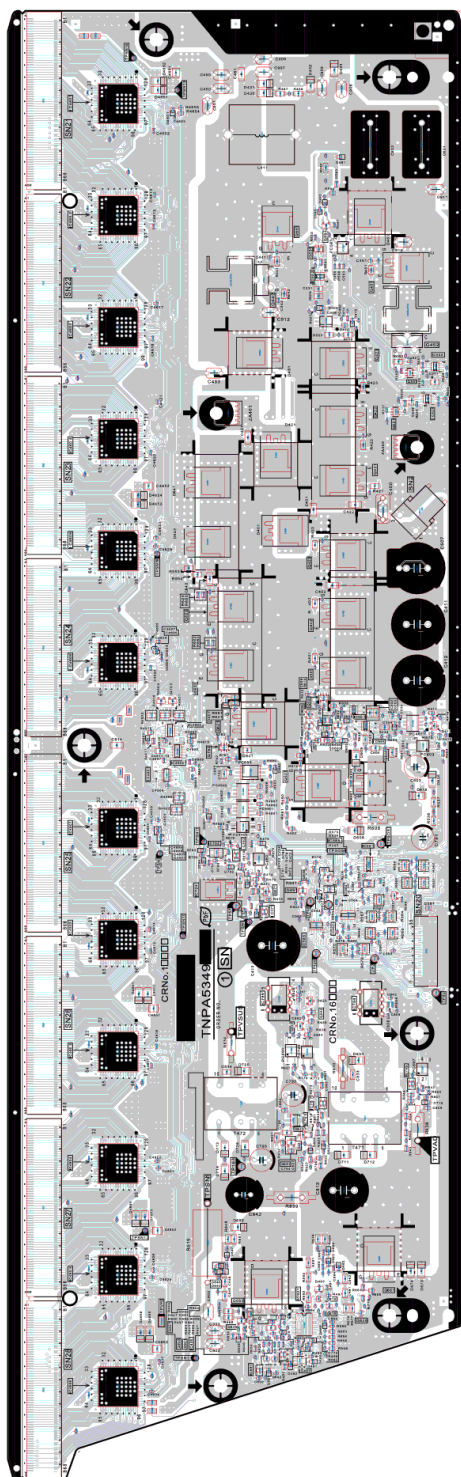

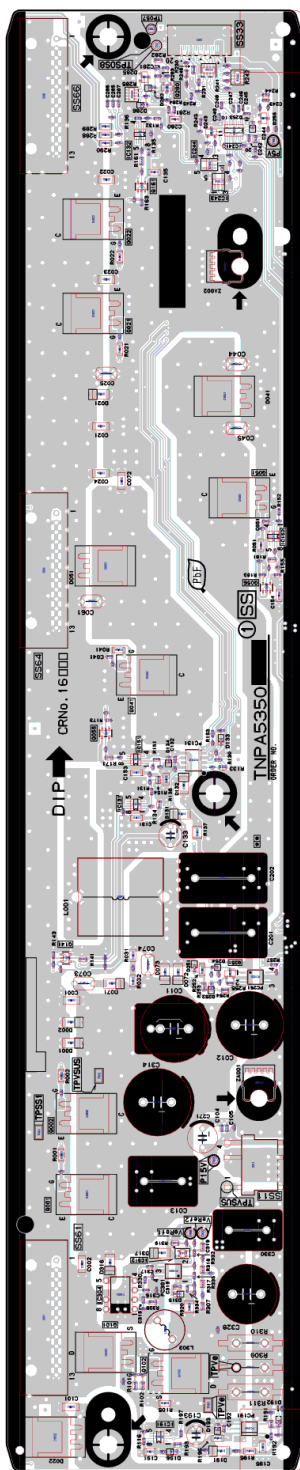
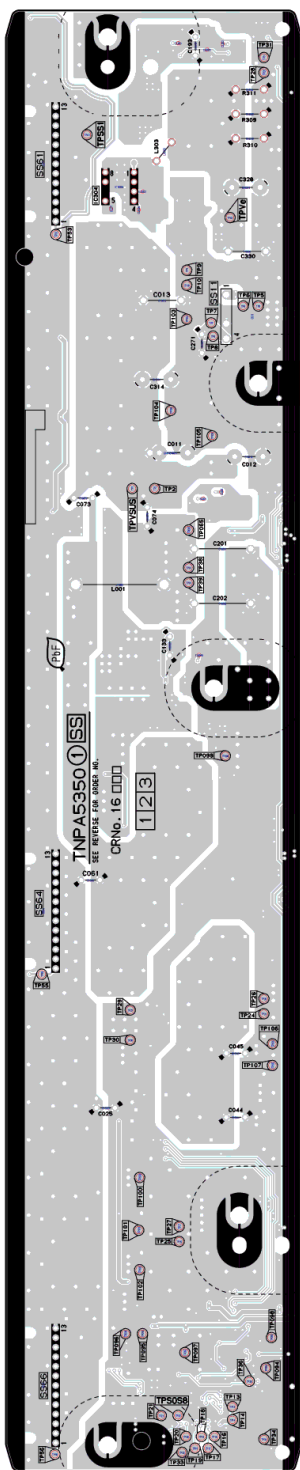

Model No. : TX-P42UT30B/Y Parts List

Safety	Ref. No.	Part No.	Part Name & Description	Q'ty	Remarks
	PCB	N0AE6KK00008	CIRCUIT BOARD P	1	PAVCCZ
	PCB	A-P42UT30B	CIRCUIT BOARD A	1	(B) (RTL) PAVCCZ
	PCB	A-P42UT30Y	CIRCUIT BOARD A	1	(Y) (RTL) PAVCCZ
	PCB	TXN/K1RLUE	CIRCUIT BOARD K	1	(RTL) PAVCCZ
	PCB	TXN/V1RRUE	CIRCUIT BOARD V	1	(RTL) PAVCCZ
	PCB	TXNC111DHK	CIRCUIT BOARD C1	1	(RTL) PAVCCZ
	PCB	TXNC211FHK	CIRCUIT BOARD C2	1	(RTL) PAVCCZ
	PCB	TXNSN11FHK	CIRCUIT BOARD SN	1	(RTL) PAVCCZ
	PCB	TXNSS11FHK	CIRCUIT BOARD SS	1	(RTL) PAVCCZ
	A1	K1KY08AA0719	8P CONNECTOR	1	
	A6	K1KY15B00006	15P CONNECTOR	1	
	A11	K1KY04B00013	4P CONNECTOR	1	
	A14	K1KY06AA0719	6P CONNECTOR	1	
	A20	K1MY35BA0345	35P CONNECTOR	1	
	A31	K1MY55BA0345	55P CONNECTOR	1	
	A32	K1MY55BA0345	55P CONNECTOR	1	
	A35	K1KY03AA0719	3P CONNECTOR	1	
	C0900	F1G1H101A565	C 100PF 50V	1	
	C0901	F1G1H101A565	C 100PF 50V	1	
	C2000	F1G1E1030005	C 0.01UF 25V	1	
	C2003	F1J1A106A087	C 10UF, 10V	1	
	C2004	F1J1E105A231	C 1 UF 25V	1	
	C2008	F1G1H1020008	C 1000PF 50V	1	
	C2009	F1G1E1030005	C 0.01UF 25V	1	
	C2010	F1G1C104A077	C 0.1UF 16V	1	
	C2014	F1G1C104A077	C 0.1UF 16V	1	
	C2017	F1G1C104A077	C 0.1UF 16V	1	
	C2026	F1G1H1020008	C 1000PF 50V	1	
	C2752	F1G1E1030005	C 0.01UF 25V	1	
	C2810	ECJ1VB1H103K	C 0.01UF, 50V	1	
	C2811	F1J1A106A087	C 10UF, 10V	1	
	C2815	ECJ1VB1H103K	C 0.01UF, 50V	1	
	C2821	ECJ1XB1C104K	C 0.1UF, Z, 16V	1	
	C2850	F1H1C473A041	C 0.047UF. 16V	1	
	C2851	F1H1C473A041	C 0.047UF. 16V	1	
	C2852	F1H1C473A041	C 0.047UF. 16V	1	
	C2853	F1H1C473A041	C 0.047UF. 16V	1	
	C3001	F1G1A105A047	C 1UF 10V	1	
	C3002	F1G1A105A047	C 1UF 10V	1	
	C3003	F1G1C104A077	C 0.1UF 16V	1	
	C3004	F1G1C104A077	C 0.1UF 16V	1	
	C3005	F1G1A105A047	C 1UF 10V	1	
	C3006	F1G1A105A047	C 1UF 10V	1	
	C3011	F1J1A106A043	C 10UF, 10V	1	
	C3016	F1G1C104A077	C 0.1UF 16V	1	
	C3018	F1G1C104A077	C 0.1UF 16V	1	
	C3019	F1G1C104A077	C 0.1UF 16V	1	
	C3020	F1J1A106A043	C 10UF, 10V	1	
	C3084	F1J1A106A043	C 10UF, 10V	1	
	C3085	F1J1A106A043	C 10UF, 10V	1	
	C3086	F1J1A106A043	C 10UF, 10V	1	
	C3105	F1G1H5610004	C 560 pF 50 V	1	
	C3106	F1G1H5610004	C 560 pF 50 V	1	
	C3108	F1G1E333A091	C 0.033UF 25V	1	
	C3109	F1G1E333A091	C 0.033UF 25V	1	
	C3111	F1G1A105A047	C 1UF 10V	1	
	C3112	F1G1A105A047	C 1UF 10V	1	
	C3113	F1J1A106A043	C 10UF, 10V	1	
	C3120	F2H1A101A040	C 100UF, 10V	1	
	C3121	F2H1A101A040	C 100UF, 10V	1	

Model No. : TX-P42UT30B/Y Parts List

Safety	Ref. No.	Part No.	Part Name & Description	Q'ty	Remarks
	C3124	FLJ1A106A087	C 10UF, 10V	1	
	C3130	FLJ1A106A087	C 10UF, 10V	1	
	C3131	FLJ1A106A087	C 10UF, 10V	1	
	C3132	FLJ1A106A087	C 10UF, 10V	1	
	C3135	FIG1H5610004	C 560 pF 50 V	1	
	C3136	FIG1H5610004	C 560 pF 50 V	1	
	C3139	FIG1H5610004	C 560 pF 50 V	1	
	C3140	FIG1H5610004	C 560 pF 50 V	1	
	C3145	FLJ1A106A087	C 10UF, 10V	1	
	C3146	FLJ1A106A087	C 10UF, 10V	1	
	C3147	FLJ1A106A087	C 10UF, 10V	1	
	C3148	FLJ1A106A087	C 10UF, 10V	1	
	C3151	FIG1A105A047	C 1UF 10V	1	
	C3152	FIG1A105A047	C 1UF 10V	1	
	C3153	FIG1H5610004	C 560 pF 50 V	1	
	C3154	FIG1H5610004	C 560 pF 50 V	1	
	C3155	FIG1H5610004	C 560 pF 50 V	1	
	C3156	FIG1H5610004	C 560 pF 50 V	1	
	C3157	FIG1A105A047	C 1UF 10V	1	
	C3158	FIG1A105A047	C 1UF 10V	1	
	C3159	FLJ1A106A043	C 10UF, 10V	1	
	C3160	FLJ1A106A043	C 10UF, 10V	1	
	C3161	FLJ1A106A043	C 10UF, 10V	1	
	C3162	FLJ1A106A043	C 10UF, 10V	1	
	C3163	FLJ1A106A043	C 10UF, 10V	1	
	C3172	FIG1A105A047	C 1UF 10V	1	
	C3173	FIG1A105A047	C 1UF 10V	1	
	C3174	FIG1A105A047	C 1UF 10V	1	
	C3175	FIG1A105A047	C 1UF 10V	1	
	C3178	FLJ1A106A043	C 10UF, 10V	1	
	C3179	FLJ1A106A043	C 10UF, 10V	1	
	C4546	FIG1A105A047	C 1UF 10V	1	
	C4548	FIG1A105A047	C 1UF 10V	1	
	C4800	FIG1A105A047	C 1UF 10V	1	
	C4801	FIG1A105A047	C 1UF 10V	1	
	C4802	FIG1H220A565	C 22PF, 50V	1	
	C4807	FLJ1A106A043	C 10UF, 10V	1	
	C4808	FIG1C104A077	C 0.1UF 16V	1	
	C4811	FLJ1A106A043	C 10UF, 10V	1	
	C4812	FIG1H1020008	C 1000PF 50V	1	
	C4816	FIG1H1020008	C 1000PF 50V	1	
	C4817	FIG1H330A565	C 33PF, 50V	1	
	C4818	FIG1H330A565	C 33PF, 50V	1	
	C4820	FLJ1E105A231	C 1 UF 25V	1	
	C4821	ECJ1VB1A105K	C 1UF, 10V	1	
	C4823	FIG1H1020008	C 1000PF 50V	1	
	C4825	FIG1H150A565	C 15PF, 50V	1	
	C4826	FIG1H150A565	C 15PF, 50V	1	
	C4899	FLJ1A106A043	C 10UF, 10V	1	
	C4908	FIG1H1020008	C 1000PF 50V	1	
	C4909	FLJ1E105A231	C 1 UF 25V	1	
	C4910	FK1E106A136	C 10UF, 25V	1	
	C4911	FIH1H104A970	C 0.1UF, , 50V	1	
	C4912	FLJ1E105A231	C 1 UF 25V	1	
	C4913	FIH1H104A970	C 0.1UF, , 50V	1	
	C4914	FLJ1E105A231	C 1 UF 25V	1	
	C4915	FIH1H104A970	C 0.1UF, , 50V	1	
	C4916	FK1E106A136	C 10UF, 25V	1	
	C4917	FIH1H104A970	C 0.1UF, , 50V	1	
	C4918	FLJ1E105A231	C 1 UF 25V	1	
	C4919	FIG1H1020008	C 1000PF 50V	1	
	C4921	FLJ1E4740001	C 0.47UF, 25V	1	

Model No. : TX-P42UT30B/Y Parts List

Safety	Ref. No.	Part No.	Part Name & Description	Q'ty	Remarks
	C4922	FLJ1E4740001	C 0.47UF, 25V	1	
	C4924	FLJ1E4740001	C 0.47UF, 25V	1	
	C4925	FLJ1E4740001	C 0.47UF, 25V	1	
	C4934	FIG1H1020008	C 1000PF 50V	1	
	C4935	FIG1H1020008	C 1000PF 50V	1	
	C4936	FIG1H1020008	C 1000PF 50V	1	
	C4937	FIG1H1020008	C 1000PF 50V	1	
	C4938	FK1E106A136	C 10UF, 25V	1	
	C4939	FK1E106A136	C 10UF, 25V	1	
	C4970	FLJ1A106A087	C 10UF, 10V	1	
	C4971	FLJ1A106A087	C 10UF, 10V	1	
	C4972	F2H1A101A040	C 100UF, 10V	1	
	C4973	F2H1A101A040	C 100UF, 10V	1	
	C5000	FIG1E1030005	C 0.01UF 25V	1	
	C5002	FLJ1E105A231	C 1 UF 25V	1	
	C5003	FIG1C105A145	C 1 uF 16 V	1	
	C5012	EEH1C101UF	C 100PF, J, 16V	1	
	C5013	ECJ1VB1A105K	C 1UF, 10V	1	
	C5014	ECJ1VB1A105K	C 1UF, 10V	1	
	C5015	ECJ1VB1A105K	C 1UF, 10V	1	
	C5016	ECJ1VB1A105K	C 1UF, 10V	1	
	C5017	ECJ1VB1A105K	C 1UF, 10V	1	
	C5018	FIG1C104A077	C 0.1UF 16V	1	
	C5020	FIG1E1030005	C 0.01UF 25V	1	
	C5023	FK1E106A136	C 10UF, 25V	1	
	C5031	ECJ1VB1A105K	C 1UF, 10V	1	
	C5032	ECJ1VB1A105K	C 1UF, 10V	1	
	C5440	FK1E106A136	C 10UF, 25V	1	
	C5442	FIG1C223A081	C 0.022UF, 16V	1	
	C5443	FLJ1A106A043	C 10UF, 10V	1	
	C5444	FLJ1A106A043	C 10UF, 10V	1	
	C5447	FIG1A333A032	C0.033UF, 10V	1	
	C5448	FIG1H5610004	C 560 pF 50 V	1	
	C5900	FLJ1A106A043	C 10UF, 10V	1	
	C5901	FLJ1A106A043	C 10UF, 10V	1	
	C5902	FLJ1A106A043	C 10UF, 10V	1	
	C5905	FIG1C223A081	C 0.022UF, 16V	1	
	C5906	FK1E106A136	C 10UF, 25V	1	
	C5908	FIG1A333A032	C0.033UF, 10V	1	
	C5909	FIG1H1020008	C 1000PF 50V	1	
	C5911	FLJ1A106A043	C 10UF, 10V	1	
	C5912	FIG1E472A086	C 4700pF 25V	1	
	C5913	FIG1A473A032	C0.047UF, 10V	1	
	C5915	FIG1A473A032	C0.047UF, 10V	1	
	C5917	FIG1A473A032	C0.047UF, 10V	1	
	C5919	FIG1A473A032	C0.047UF, 10V	1	
	C6700	FIG1C104A077	C 0.1UF 16V	1	
	C6701	FIG1C104A077	C 0.1UF 16V	1	
	C6702	FIG1C104A077	C 0.1UF 16V	1	
	C6703	FIG1H100A565	C 10PF 50V	1	
	C6704	FIG1H100A565	C 10PF 50V	1	
	C6705	FIG1C104A077	C 0.1UF 16V	1	
	C6707	FIG1C104A077	C 0.1UF 16V	1	
	C6708	FIG1C104A077	C 0.1UF 16V	1	
	C6709	FLJ1A106A087	C 10UF, 10V	1	
	C6711	FIG1C104A077	C 0.1UF 16V	1	
	C6712	FIG1C104A077	C 0.1UF 16V	1	
	C6713	FIG1C104A077	C 0.1UF 16V	1	
	C6714	FIG1C104A077	C 0.1UF 16V	1	
	C6715	FIG1C104A077	C 0.1UF 16V	1	
	C6716	FIG1C104A077	C 0.1UF 16V	1	
	C6717	FIG1C104A077	C 0.1UF 16V	1	

Model No. : TX-P42UT30B/Y Parts List

Safety	Ref. No.	Part No.	Part Name & Description	Q'ty	Remarks
	C6718	ECJ1VB1A105K	C 1UF, 10V	1	
	C6719	FIG1C104A077	C 0.1UF 16V	1	
	C6720	FIJ1A106A087	C 10UF, 10V	1	
	C6721	FIG1H101A565	C 100PF 50V	1	
	C6722	FIG1H101A565	C 100PF 50V	1	
	C6723	FIG1C104A077	C 0.1UF 16V	1	
	C6724	FIG1C104A077	C 0.1UF 16V	1	
	C6727	FIG1C104A077	C 0.1UF 16V	1	
	C6729	FIG1C104A077	C 0.1UF 16V	1	
	C6730	ECJ1VB1A105K	C 1UF, 10V	1	
	C6750	FIJ1A475A087	C 4.7UF, 10V	1	
	C6751	FIJ1A106A087	C 10UF, 10V	1	
	C6787	FIJ1A106A087	C 10UF, 10V	1	
	C6788	FIJ1A106A087	C 10UF, 10V	1	
	C8001	FIG1C104A077	C 0.1UF 16V	1	
	C8002	FIJ1A106A087	C 10UF, 10V	1	
	C8003	FIG1C104A077	C 0.1UF 16V	1	
	C8004	FIG1C104A077	C 0.1UF 16V	1	
	C8005	FIG1C104A077	C 0.1UF 16V	1	
	C8006	FIG1C104A077	C 0.1UF 16V	1	
	C8007	FIG1C104A077	C 0.1UF 16V	1	
	C8008	FIG1C104A077	C 0.1UF 16V	1	
	C8009	FIJ1A106A087	C 10UF, 10V	1	
	C8011	FIG1C104A077	C 0.1UF 16V	1	
	C8013	FIG1C104A077	C 0.1UF 16V	1	
	C8014	FIG1C104A077	C 0.1UF 16V	1	
	C8015	FIG1C104A077	C 0.1UF 16V	1	
	C8016	FIG1C104A077	C 0.1UF 16V	1	
	C8017	FIJ1A106A087	C 10UF, 10V	1	
	C8018	FIG1C104A077	C 0.1UF 16V	1	
	C8019	FIG1C104A077	C 0.1UF 16V	1	
	C8020	FIG1C104A077	C 0.1UF 16V	1	
	C8021	FIG1C104A077	C 0.1UF 16V	1	
	C8022	FIJ1A106A087	C 10UF, 10V	1	
	C8023	FIJ1A106A087	C 10UF, 10V	1	
	C8024	FIJ0G2260001	C 22 UF 4 V	1	
	C8026	FIG1C104A077	C 0.1UF 16V	1	
	C8027	FIG1C104A077	C 0.1UF 16V	1	
	C8028	FIG1C104A077	C 0.1UF 16V	1	
	C8030	FIG1C104A077	C 0.1UF 16V	1	
	C8032	FIG1C104A077	C 0.1UF 16V	1	
	C8036	FIG1C104A077	C 0.1UF 16V	1	
	C8039	FIG1C104A077	C 0.1UF 16V	1	
	C8041	FIG1H1020008	C 1000PF 50V	1	
	C8042	FIG1C104A077	C 0.1UF 16V	1	
	C8043	FIG1C104A077	C 0.1UF 16V	1	
	C8044	FIG1C104A077	C 0.1UF 16V	1	
	C8045	FIG1C104A077	C 0.1UF 16V	1	
	C8047	FIG1C104A077	C 0.1UF 16V	1	
	C8048	FIG1C104A077	C 0.1UF 16V	1	
	C8049	FIJ1A106A087	C 10UF, 10V	1	
	C8050	FIG1C104A077	C 0.1UF 16V	1	
	C8051	FIJ1A106A087	C 10UF, 10V	1	
	C8052	FIG1C104A077	C 0.1UF 16V	1	
	C8053	FIG1C104A077	C 0.1UF 16V	1	
	C8054	FIG1C104A077	C 0.1UF 16V	1	
	C8055	FIG1C104A077	C 0.1UF 16V	1	
	C8056	FIG1C104A077	C 0.1UF 16V	1	
	C8057	FIG1C104A077	C 0.1UF 16V	1	
	C8100	FIG1E682A123	C 6800 pF 25 V	1	
	C8102	FIJ1A475A087	C 4.7UF, 10V	1	
	C8104	FIH1C105A145	C 1 uF 16 V	1	

Model No. : TX-P42UT30B/Y Parts List

Safety	Ref. No.	Part No.	Part Name & Description	Q'ty	Remarks
	C8106	FIG1C223A081	C 0.022UF, 16V	1	
	C8108	FIG1C104A077	C 0.1UF 16V	1	
	C8110	FIG1C104A077	C 0.1UF 16V	1	
	C8112	FK1E106A136	C 10UF, 25V	1	
	C8114	FK1E106A136	C 10UF, 25V	1	
	C8116	FK1E106A136	C 10UF, 25V	1	
	C8118	FK1E106A136	C 10UF, 25V	1	
	C8120	FIJOG2260001	C 22 UF 4 V	1	
	C8122	FIJOG2260001	C 22 UF 4 V	1	
	C8124	FIJOG2260001	C 22 UF 4 V	1	
	C8126	FIJOG2260001	C 22 UF 4 V	1	
	C8128	FIJOG2260001	C 22 UF 4 V	1	
	C8200	FIG1C104A077	C 0.1UF 16V	1	
	C8201	FIG1C104A077	C 0.1UF 16V	1	
	C8202	FIG1C104A077	C 0.1UF 16V	1	
	C8203	FIG1C104A077	C 0.1UF 16V	1	
	C8204	FIG1C104A077	C 0.1UF 16V	1	
	C8205	FIJ1A106A087	C 10UF, 10V	1	
	C8206	FIG1C104A077	C 0.1UF 16V	1	
	C8208	FIG1C104A077	C 0.1UF 16V	1	
	C8210	FIG1C104A077	C 0.1UF 16V	1	
	C8213	FIG1C104A077	C 0.1UF 16V	1	
	C8214	FIJ1A106A087	C 10UF, 10V	1	
	C8216	FIG1C104A077	C 0.1UF 16V	1	
	C8218	FIG1C104A077	C 0.1UF 16V	1	
	C8219	FIG1C104A077	C 0.1UF 16V	1	
	C8222	FIG1C104A077	C 0.1UF 16V	1	
	C8223	FIG1C104A077	C 0.1UF 16V	1	
	C8224	FIG1C104A077	C 0.1UF 16V	1	
	C8225	FIG1C104A077	C 0.1UF 16V	1	
	C8226	FIG1C104A077	C 0.1UF 16V	1	
	C8227	FIG1C104A077	C 0.1UF 16V	1	
	C8300	FIG1H9R0A732	C 9 PF, 50V	1	
	C8301	FIG1H8R0A564	C 8 PF, 50V	1	
	C8302	FIG1C104A077	C 0.1UF 16V	1	
	C8303	FIG1C104A077	C 0.1UF 16V	1	
	C8304	FIG1C104A077	C 0.1UF 16V	1	
	C8305	FIG1A105A047	C 1UF 10V	1	
	C8306	FIG1A105A047	C 1UF 10V	1	
	C8307	FIG1A105A047	C 1UF 10V	1	
	C8308	FIG1A105A047	C 1UF 10V	1	
	C8309	FIG1A105A047	C 1UF 10V	1	
	C8310	FIG1A105A047	C 1UF 10V	1	
	C8311	FIG1A105A047	C 1UF 10V	1	
	C8401	FIG1C104A077	C 0.1UF 16V	1	
	C8402	FK0J226A049	C 22UF, 6.3V	1	
	C8403	FK0J226A049	C 22UF, 6.3V	1	
	C8406	FIG1C104A077	C 0.1UF 16V	1	
	C8407	FIG1C104A077	C 0.1UF 16V	1	
	C8411	FIG1C104A077	C 0.1UF 16V	1	
	C8603	FIJ1A106A087	C 10UF, 10V	1	
	C8604	FIG1C104A077	C 0.1UF 16V	1	
	C8605	FIG1C104A077	C 0.1UF 16V	1	
	C8607	FIG1H100A565	C 10PF 50V	1	
	C8608	FIG1H100A565	C 10PF 50V	1	
	C8609	FIG1C104A077	C 0.1UF 16V	1	
	C8611	FIG1C104A077	C 0.1UF 16V	1	
	C8615	FIJ1A106A087	C 10UF, 10V	1	
	C8616	FIJ1A106A087	C 10UF, 10V	1	
	C8617	FIG1C104A077	C 0.1UF 16V	1	
	C8619	FIG1C104A077	C 0.1UF 16V	1	
	C8620	FIG1C104A077	C 0.1UF 16V	1	

Model No. : TX-P42UT30B/Y Parts List

Safety	Ref. No.	Part No.	Part Name & Description	Q'ty	Remarks
	C8627	FIG1C104A077	C 0.1UF 16V	1	
	C8628	FIJ0G2260001	C 22 UF 4 V	1	
	C8629	FIJ0G2260001	C 22 UF 4 V	1	
	C8630	F2H0J2210005	C 220UF, 6.3V	1	
	C8631	F2H0J2210005	C 220UF, 6.3V	1	
	C8632	FIJ1A106A087	C 10UF, 10V	1	
	C8633	FIG1C104A077	C 0.1UF 16V	1	
	C8636	FIJ1A106A043	C 10UF, 10V	1	
	C8637	FIJ1A106A087	C 10UF, 10V	1	
	C8638	FIG1C104A077	C 0.1UF 16V	1	
	C8639	FIJ1A106A087	C 10UF, 10V	1	
	C8640	FIG1C104A077	C 0.1UF 16V	1	
	C8641	FIJ1A106A043	C 10UF, 10V	1	
	C8642	FIJ1A106A087	C 10UF, 10V	1	
	C8643	FIG1C104A077	C 0.1UF 16V	1	
	C8644	FIG1C104A077	C 0.1UF 16V	1	
	C8660	FIG1H470A565	C 47PF, 50V	1	
	C8661	FIG1H470A565	C 47PF, 50V	1	
	C8738	FIJ1A475A087	C 4.7UF, 10V	1	
	C8739	FIH1C105A145	C 1 uF 16 V	1	
	C8740	FIG1E122A123	C 1200pF 25V	1	
	C8742	FIG1C104A077	C 0.1UF 16V	1	
	C8744	FIK1E106A136	C 10UF, 25V	1	
	C8746	FIK1E106A136	C 10UF, 25V	1	
	C8748	FIJ0G2260001	C 22 UF 4 V	1	
	C8750	FIJ0G2260001	C 22 UF 4 V	1	
	C8753	FIJ0G2260001	C 22 UF 4 V	1	
	C8754	FIJ1A106A087	C 10UF, 10V	1	
	C8756	FIJ1A106A087	C 10UF, 10V	1	
	C8763	FIG1C104A077	C 0.1UF 16V	1	
	C8764	FIG1C223A081	C 0.022UF, 16V	1	
	C8765	FIJ1A106A043	C 10UF, 10V	1	
	C8766	FIJ1A106A043	C 10UF, 10V	1	
	C8768	FIG1A333A032	CO.033UF, 10V	1	
	C8769	FIG1H5610004	C 560 pF 50 V	1	
	C8771	FIJ1A475A087	C 4.7UF, 10V	1	
	C8772	FIJ1A106A087	C 10UF, 10V	1	
	C8773	FIG1C104A077	C 0.1UF 16V	1	
	C8774	FIG1C104A077	C 0.1UF 16V	1	
	C8776	FIK1E106A136	C 10UF, 25V	1	
	C8777	FIG1C104A077	C 0.1UF 16V	1	
	C8780	ECJ1VB1A105K	C 1UF, 10V	1	
	C8781	ECJ1VB1A105K	C 1UF, 10V	1	
	C8786	FIG1C104A077	C 0.1UF 16V	1	
	C8787	FIG1C104A077	C 0.1UF 16V	1	
	C8789	FIK1E106A136	C 10UF, 25V	1	
	C8790	FIK1E106A136	C 10UF, 25V	1	
	C8791	FIG1C223A081	C 0.022UF, 16V	1	
	C8792	FIG1C1030008	C 0.01UF 16V	1	
	C8793	FIG1C1030008	C 0.01UF 16V	1	
	C8795	FIJ1A106A043	C 10UF, 10V	1	
	C8796	FIJ1A106A043	C 10UF, 10V	1	
	C8797	FIJ1A106A043	C 10UF, 10V	1	
	C8798	FIJ1A106A043	C 10UF, 10V	1	
	C8810	FIJ1A106A043	C 10UF, 10V	1	
	C8813	FIJ1A106A043	C 10UF, 10V	1	
	C8900	FIG1C104A077	C 0.1UF 16V	1	
	C8901	FIG1C104A077	C 0.1UF 16V	1	
	C8902	FIG1C104A077	C 0.1UF 16V	1	
	C8903	FIG1C104A077	C 0.1UF 16V	1	
	C9099	FIG1C104A077	C 0.1UF 16V	1	
	C9100	FIJ1A106A087	C 10UF, 10V	1	

Model No. : TX-P42UT30B/Y Parts List

Safety	Ref. No.	Part No.	Part Name & Description	Q'ty	Remarks
	C9101	FIG1E1030005	C 0.01UF 25V	1	
	C9102	FIG1E106A136	C 10UF, 25V	1	
	C9103	FIG1E1030005	C 0.01UF 25V	1	
	C9104	FIG1C104A077	C 0.1UF 16V	1	
	C9105	FIG1C104A077	C 0.1UF 16V	1	
	C9106	FIG1H5610004	C 560 pF 50 V	1	
	C9108	FIG1C104A077	C 0.1UF 16V	1	
	C9300	FIG1C104A077	C 0.1UF 16V	1	
	C9301	FIG1H150A565	C 15PF, 50V	1	
	C9302	FIG1H180A565	C 18PF, 50V	1	
	C9308	FIG1C104A077	C 0.1UF 16V	1	
	C9311	FIG1C104A077	C 0.1UF 16V	1	
	C9312	FIG1A106A087	C 10UF, 10V	1	
	C9313	FIG1C104A077	C 0.1UF 16V	1	
	C9328	FIG1C104A077	C 0.1UF 16V	1	
	C9330	FIG1A105A047	C 1UF 10V	1	
	C9331	FIG1A105A047	C 1UF 10V	1	
	C9332	FIG1A105A047	C 1UF 10V	1	
	C9337	FIG1A106A087	C 10UF, 10V	1	
	C9362	FIG1C104A077	C 0.1UF 16V	1	
	C9366	FIG1A105A047	C 1UF 10V	1	
	C9371	FIG1A106A087	C 10UF, 10V	1	
	C9375	FIG1C104A077	C 0.1UF 16V	1	
	C9380	FIG1C104A077	C 0.1UF 16V	1	
	C9389	FIG1A105A047	C 1UF 10V	1	
	C9392	FIG1A106A087	C 10UF, 10V	1	
	C9400	FIG1C104A077	C 0.1UF 16V	1	
	C9401	FIG1C104A077	C 0.1UF 16V	1	
	C9402	FIG1C104A077	C 0.1UF 16V	1	
	C9404	FIG1C104A077	C 0.1UF 16V	1	
	C9407	FIG1C104A077	C 0.1UF 16V	1	
	C9409	FIG1A106A087	C 10UF, 10V	1	
	C9411	FIG1A106A087	C 10UF, 10V	1	
	C9413	FIG1A106A087	C 10UF, 10V	1	
	C9415	FIG1A106A087	C 10UF, 10V	1	
	CN0100	K1KA14A00248	14P CONNECTOR	1	
	CN8400	K1NA68B00059	68P CONNECTOR	1	PAVCCZ
	CN8600	K1NA12E00016	12P CONNECTOR	1	
	D2820	B3AGB0000065	LED	1	
	D2850	B3EB00000056	LED	1	
	D2851	B3EB00000056	LED	1	
	D2852	B3EB00000056	LED	1	
	D2853	B3EB00000056	LED	1	
	D3015	K7AAAY000006	PHOTO LINK	1	
	D3130	B0ACJ0000048	DIODE	1	
	D4703	DZ2J056M0L	ZENER DIODE	1	
	D4704	B0JCCD000020	DIODE	1	
	D4720	DZ2J056M0L	ZENER DIODE	1	
	D4721	B0JCCD000020	DIODE	1	
	D4773	B0JCCE000008	DIODE	1	
	D4774	DZ2J056M0L	ZENER DIODE	1	
	D4775	B0JCCD000020	DIODE	1	
	D5401	B0JCMD000066	ZENER DIODE	1	
	D5900	B0JCMD000066	ZENER DIODE	1	
	D8711	B0ADCJ000100	DIODE	1	
	D8712	DZ2J068M0L	ZENER DIODE	1	
	D8713	DZ2J068M0L	ZENER DIODE	1	
	D8717	B0ACJ0000048	DIODE	1	
	D8718	B0JCMD000066	ZENER DIODE	1	
	D8719	DZ2J068M0L	ZENER DIODE	1	

Model No. : TX-P42UT30B/Y Parts List

Safety	Ref. No.	Part No.	Part Name & Description	Q'ty	Remarks
	D8720	B0ADCJ000100	DIODE	1	
	D8721	DZ2J068M0L	ZENER DIODE	1	
	D9806	B0ADCJ000100	DIODE	1	
	D9807	B0ADCJ000100	DIODE	1	
	IC2001	C1ZBZ0004368	IC	1	
	IC3001	C1AB00003384	IC	1	
	IC4800	C0DBGYY02190	IC	1	
	IC4900	C1AB00003705	IC	1	
	IC5000	AN34044A-VF	IC	1	
	IC5002	C0DBGHC00003	IC	1	
	IC5440	C0DBAYY00931	IC	1	
	IC5900	C0DBAYY00931	IC	1	
	IC5901	C1ZBZ0004339	IC	1	
	IC6700	C1AB00003273	IC	1	
	IC6701	C0CBCYY00043	IC	1	
	IC6750	C0CBCAG00031	IC	1	
	IC6776	C0DBAGF00030	IC	1	
	IC8000	MN2WS0200LE	IC	1	
	IC8100	C0DBAYY00715	IC	1	
	IC8200	C3ABUY000009	IC	1	
	IC8201	C3ABTY000025	IC	1	(Y)
	IC8201	C3ABUY000004	IC	1	(B)
	IC8403	C0JBAZ003032	IC	1	
	IC8404	C0DBZYY00382	IC	1	
	IC8601	C1CB00003491	IC	1	
	IC8602	C0DBZYY00450	IC	1	
	IC8603	C0DBZYY00368	IC	1	
	IC8604	C0DBAGF00030	IC	1	
	IC8700	C0DBAYY00737	IC	1	
	IC8701	C0DBAYY00931	IC	1	
	IC8702	C0DBAFG00029	IC	1	
	IC8704	C0CBCAG00046	IC	1	
	IC8706	C0DBGYY00887	IC	1	
	IC8707	C0DBAYY00915	IC	1	
	IC8714	C0DBGYY01682	IC	1	
	IC8900	TVRS076AW	IC	1	(Y) PAVCCZ
	IC8900	TVRS077AW	IC	1	(B) PAVCCZ
	IC8901	TVR***1B	IC	1	(B) PAVCCZ
	IC8901	TVR***1Y	IC	1	(Y) PAVCCZ
	IC8902	TVR***2B	IC	1	(B) PAVCCZ
	IC8902	TVR***2Y	IC	1	(Y) PAVCCZ
	IC9300	C1AB00003461	IC	1	
	IC9304	TVRS209AB	IC	1	PAVCCZ
	IC9400	C0JBAU000089	IC	1	
	IC9401	C0JBAU000089	IC	1	
	IC9402	C0JBAU000089	IC	1	
	JK3002	K1FY121A0011	CONNECTOR	1	PAVCCZ
	JK3100	K1U710A00001	CONNECTOR	1	PAVCCZ
	JK3707	K4AK13B00008	TERMINAL BOARD	1	
	JK4700	K1FY119D0015	CONNECTOR	1	
	JK4702	K1FY119D0015	CONNECTOR	1	
	JK4703	K1FY119E0028	CONNECTOR	1	PAVCCZ
	JK8600	K2LC108A0012	JACK	1	
	JK8601	K1FY208B00008	CONNECTOR	1	
	K1	K1KA08B00270	8P CONNECTOR	1	
	L2751	J0JHC0000045	CHIP INDUCTOR	1	
	L3100	J0JYC0000331	CHIP INDUCTOR	1	
	L3101	J0JYC0000331	CHIP INDUCTOR	1	

Model No. : TX-P42UT30B/Y Parts List

Safety	Ref. No.	Part No.	Part Name & Description	Q'ty	Remarks
	L3104	J0JCC0000287	CHIP INDUCTOR	1	
	L3108	J0JCC0000287	CHIP INDUCTOR	1	
	L3111	J0JCC0000287	CHIP INDUCTOR	1	
	L3112	J0JCC0000287	CHIP INDUCTOR	1	
	L3113	J0JYC0000331	CHIP INDUCTOR	1	
	L3116	J0JYC0000331	CHIP INDUCTOR	1	
	L3117	J0JYC0000331	CHIP INDUCTOR	1	
	L3118	J0JYC0000331	CHIP INDUCTOR	1	
	L3119	J0JYC0000331	CHIP INDUCTOR	1	
	L3120	J0JYC0000331	CHIP INDUCTOR	1	
	L3300	J0ZZB0000150	FILTER	1	
	L3301	J0ZZB0000150	FILTER	1	
	L4702	J0JYC0000068	CHIP INDUCTOR	1	
	L4708	J0JYC0000068	CHIP INDUCTOR	1	
	L4717	J0JYC0000068	CHIP INDUCTOR	1	
	L4800	G1CR39J00009	INDUCTION COIL	1	
	L4801	G1CR39J00009	INDUCTION COIL	1	
	L4802	J0JGC0000020	CHIP INDUCTOR	1	
	L4803	J0JGC0000020	CHIP INDUCTOR	1	
	L4805	J0JGC0000020	CHIP INDUCTOR	1	
	L4807	J0JCC0000278	CHIP INDUCTOR	1	
	L4900	G1C150MA0426	INDUCTION COIL	1	
	L4901	G1C150MA0426	INDUCTION COIL	1	
	L4902	G1C150MA0426	INDUCTION COIL	1	
	L4903	G1C150MA0426	INDUCTION COIL	1	
	L5440	G1C6R8MA0445	INDUCTION COIL	1	
	L5900	G1C6R8MA0445	INDUCTION COIL	1	
	L6700	J0JGC0000020	CHIP INDUCTOR	1	
	L6705	J0JGC0000020	CHIP INDUCTOR	1	
	L8001	J0JCC0000287	CHIP INDUCTOR	1	
	L8002	J0JHC0000045	CHIP INDUCTOR	1	
	L8003	J0JHC0000045	CHIP INDUCTOR	1	
	L8005	J0JKC0000021	CHIP INDUCTOR	1	
	L8006	J0JCC0000287	CHIP INDUCTOR	1	
	L8007	J0JCC0000287	CHIP INDUCTOR	1	
	L8100	G1C4R7MA0416	INDUCTION COIL	1	
	L8102	G1C3R3MA0460	INDUCTION COIL	1	
	L8600	J0JHC0000045	CHIP INDUCTOR	1	
	L8603	J0JHC0000045	CHIP INDUCTOR	1	
	L8604	J0JHC0000045	CHIP INDUCTOR	1	
	L8620	J0ZZB0000142	FILTER	1	
	L8621	J0ZZB0000142	FILTER	1	
	L8700	G1C2R2MA0449	INDUCTION COIL	1	
	L8702	G1C6R8MA0445	INDUCTION COIL	1	
	L8703	G1C6R8MA0445	INDUCTION COIL	1	
	L8705	D0GBR00J0004	M 0 OHM J 1/10W	1	
	L8706	J0JGC0000020	CHIP INDUCTOR	1	
	L9303	J0JHC0000117	CHIP INDUCTOR	1	
	PA2005	K5H4022A0031	FUSE	1	
	PA5400	K5H5022A0031	FUSE	1	
	PA5900	K5H1022A0031	FUSE	1	
	Q0900	B1ADCF000194	TRANSISTOR	1	
	Q2810	B1ABCE000015	TRANSISTOR	1	
	Q2811	B1ABCE000015	TRANSISTOR	1	
	Q2812	B1ABCE000015	TRANSISTOR	1	
	Q3008	DSA2001S0L	TRANSISTOR	1	
	Q3102	B1AAF0000004	TRANSISTOR	1	
	Q3103	B1AAF0000004	TRANSISTOR	1	
	Q3104	B1AAF0000004	TRANSISTOR	1	
	Q3105	B1AAF0000004	TRANSISTOR	1	

Model No. : TX-P42UT30B/Y Parts List

Safety	Ref. No.	Part No.	Part Name & Description	Q'ty	Remarks
	Q4513	DSA2001S0L	TRANSISTOR	1	
	Q4514	B1HFCEA00001	TRANSISTOR	1	
	Q4700	B1ABCF000231	TRANSISTOR	1	
	Q4702	B1ABCF000231	TRANSISTOR	1	
	Q4710	B1ABCF000231	TRANSISTOR	1	
	Q4970	B1ADCF000194	TRANSISTOR	1	
	Q4971	B1AAF000004	TRANSISTOR	1	
	Q4972	B1AAF000004	TRANSISTOR	1	
	Q4974	DSC2001S0L	TRANSISTOR	1	
	Q8100	B1CFRD000077	FET	1	
	Q8101	B1CFRD000077	FET	1	
	Q8102	B1MBEDA00027	FET	1	
	Q8701	B1MBEDA00027	FET	1	
	Q8709	B1ADCF000194	TRANSISTOR	1	
	Q8710	B1ADCF000194	TRANSISTOR	1	
	Q8711	DSC2001S0L	TRANSISTOR	1	
	R008	D0GBR00J0004	M 0 OHM J 1/10W	1	(Y)
	R010	D0GBR00J0004	M 0 OHM J 1/10W	1	(B)
	R0902	D0GA473JA015	M 47KOHM, J,1/16W	1	
	R0903	D0GA272JA023	M 2.7KOHM, J,1/16W	1	
	R0904	D0GA272JA023	M 2.7KOHM, J,1/16W	1	
	R0905	D0GA272JA023	M 2.7KOHM, J,1/16W	1	
	R0906	D0GA272JA023	M 2.7KOHM, J,1/16W	1	
	R0907	D0GA272JA023	M 2.7KOHM, J,1/16W	1	
	R0908	D0GA272JA023	M 2.7KOHM, J,1/16W	1	
	R0909	D0GA272JA023	M 2.7KOHM, J,1/16W	1	
	R0910	D0GA272JA023	M 2.7KOHM, J,1/16W	1	
	R0911	EXB28V332J	M 3.3 KOHM 1/32 W	1	
	R0912	D0GA101JA015	M 100 OHM, J,1/16W	1	
	R0913	D0GA101JA015	M 100 OHM, J,1/16W	1	
	R0951	D0GA473JA015	M 47KOHM, J,1/16W	1	
	R0952	D0GA102JA023	M1KOHM, J,1/16 W	1	
	R1201	D0GA103JA015	M 10KOHM, J,1/16W	1	
	R1202	D0GA103JA015	M 10KOHM, J,1/16W	1	
	R1305	D0GA103JA015	M 10KOHM, J,1/16W	1	
	R1350	D0GA103JA015	M 10KOHM, J,1/16W	1	
	R2004	D1BA1432A014	M14.3KOHM, F,1/16 W	1	PAVCCZ
	R2005	D1BA6651A014	M6.65KOHM, J,1/16 W	1	PAVCCZ
	R2006	D1BA7151A014	M7.15KOHM, J,1/16 W	1	
	R2007	ERJ2RKF1741	M 1.74KOHM, F 1/16 W	1	
	R2010	D1BA7151A014	M7.15KOHM, J,1/16 W	1	
	R2011	D0GA102JA023	M1KOHM, J,1/16 W	1	
	R2012	D0GA103JA015	M 10KOHM, J,1/16W	1	
	R2705	D0GA101JA015	M 100 OHM, J,1/16W	1	
	R2752	D0GA184JA023	M 180KOHM J,1/16W	1	
	R2810	D0GB470JA065	M 47 OHM, J,1/10W	1	
	R2811	D0GB104JA065	M 100KOHM J 1/10W	1	
	R2812	D0GB224JA065	M 220KOHM, J,1/10W	1	
	R2813	D0GB223JA065	M 22KOHM, J,1/10W	1	
	R2814	D0GB103JA065	M 10K OHM J 1/10W	1	
	R2815	D0GB473JA065	M 47KOHM J. 1/10W	1	
	R2816	D1BB1621A055	M1.62KOHM, J,1/10W	1	
	R2817	D0GB223JA065	M 22KOHM, J,1/10W	1	
	R2818	D0GB473JA065	M 47KOHM J. 1/10W	1	
	R2819	D1BB4301A055	M4.30KOHM, J,1/10W	1	
	R3001	D0GA102JA023	M1KOHM, J,1/16 W	1	
	R3002	D0GA122JA023	M 1.2KOHM, J,1/16W	1	
	R3003	D0GA103JA015	M 10KOHM, J,1/16W	1	
	R3004	D0GA103JA015	M 10KOHM, J,1/16W	1	
	R3030	D0GA101JA015	M 100 OHM, J,1/16W	1	
	R3104	D0GBR00J0004	M 0 OHM J 1/10W	1	

Model No. : TX-P42UT30B/Y Parts List

Safety	Ref. No.	Part No.	Part Name & Description	Q'ty	Remarks
	R3106	D0GA333JA023	M 33KOHM, J, 1/16W	1	
	R3107	D0GA333JA023	M 33KOHM, J, 1/16W	1	
	R3109	D1BF75R0A011	M 75.0 OHM, 1/4W	1	
	R3117	D0GA221JA023	M220 OHM, J.1/16 W	1	
	R3121	EXB28V221J	M220 OHM 1/32 W	1	
	R3129	D0GA104JA023	M100KOHM, J.1/16 W	1	
	R3137	D0GD750JA052	M 75 OHM, J, 1/8W	1	
	R3141	D1BF75R0A011	M 75.0 OHM, 1/4W	1	
	R3142	D1BF75R0A011	M 75.0 OHM, 1/4W	1	
	R3143	D1BF75R0A011	M 75.0 OHM, 1/4W	1	
	R3147	D1BF75R0A011	M 75.0 OHM, 1/4W	1	
	R3153	D0GA221JA023	M220 OHM, J.1/16 W	1	
	R3157	EXB28V221J	M220 OHM 1/32 W	1	
	R3163	D0GA104JA023	M100KOHM, J.1/16 W	1	
	R3164	D0GA104JA023	M100KOHM, J.1/16 W	1	
	R3167	D0GA333JA023	M 33KOHM, J, 1/16W	1	
	R3168	D0GA333JA023	M 33KOHM, J, 1/16W	1	
	R3171	D0GA222JA023	M 2.2KOHM, J, 1/16W	1	
	R3172	D0GA222JA023	M 2.2KOHM, J, 1/16W	1	
	R3173	EXB28V221J	M220 OHM 1/32 W	1	
	R3174	D0GA221JA023	M220 OHM, J.1/16 W	1	
	R3175	D0GA221JA023	M220 OHM, J.1/16 W	1	
	R3179	D0GA331JA023	M 330 OHM, J, 1/16W	1	
	R3180	D0GA331JA023	M 330 OHM, J, 1/16W	1	
	R3181	D1BD75R0A066	M 75.0 OHM, F.1/8 W	1	
	R3182	D1BD75R0A066	M 75.0 OHM, F.1/8 W	1	
	R3183	D1BD75R0A066	M 75.0 OHM, F.1/8 W	1	
	R3184	D0GA104JA023	M100KOHM, J.1/16 W	1	
	R3185	D0GA104JA023	M100KOHM, J.1/16 W	1	
	R3186	D0GA333JA023	M 33KOHM, J, 1/16W	1	
	R3187	D0GA333JA023	M 33KOHM, J, 1/16W	1	
	R3190	D0GA222JA023	M 2.2KOHM, J, 1/16W	1	
	R3191	D0GA222JA023	M 2.2KOHM, J, 1/16W	1	
	R3192	EXB28V820JX	M 82 OHM 1/32 W	1	
	R3194	D0GA331JA023	M 330 OHM, J, 1/16W	1	
	R3195	D0GA331JA023	M 330 OHM, J, 1/16W	1	
	R3198	D0GA680JA023	M 68 OHM, J, 1/16W	1	
	R3202	D1BF75R0A011	M 75.0 OHM, 1/4W	1	
	R3204	D1BA2152A014	M21.5KOHM, J.1/16 W	1	
	R3206	D1BA1302A014	M 13KOHM, F.1/16 W	1	
	R3208	D0GA273JA023	M 27K OHM J, 1/16W	1	
	R3212	D0GA680JA023	M 68 OHM, J, 1/16W	1	
	R3213	D0GA473JA015	M 47KOHM, J, 1/16W	1	
	R3290	D0GA473JA015	M 47KOHM, J, 1/16W	1	
	R3291	D0GA473JA015	M 47KOHM, J, 1/16W	1	
	R4548	D0GA220JA023	M22 OHM, J.1/16 W	1	
	R4549	D0GA151JA023	M 150 OHM, J, 1/16W	1	
	R4550	D0GA151JA023	M 150 OHM, J, 1/16W	1	
	R4551	D0GA151JA023	M 150 OHM, J, 1/16W	1	
	R4552	D0GA560JA023	M 56 OHM, J, 1/16W	1	
	R4553	D0GA103JA015	M 10KOHM, J, 1/16W	1	
	R4554	D0GA102JA023	M1KOHM, J.1/16 W	1	
	R4563	D0GA103JA015	M 10KOHM, J, 1/16W	1	
	R4599	D0GA473JA015	M 47KOHM, J, 1/16W	1	
	R4702	D0GA103JA015	M 10KOHM, J, 1/16W	1	
	R4708	D0GA103JA015	M 10KOHM, J, 1/16W	1	
	R4709	D0GA103JA015	M 10KOHM, J, 1/16W	1	
	R4710	EXB28V473JX	M 47KOHM 1/32 W	1	
	R4711	D0GA102JA023	M1KOHM, J.1/16 W	1	
	R4715	D0GA103JA015	M 10KOHM, J, 1/16W	1	
	R4721	D0GA103JA015	M 10KOHM, J, 1/16W	1	
	R4722	D0GA103JA015	M 10KOHM, J, 1/16W	1	

Model No. : TX-P42UT30B/Y Parts List

Safety	Ref. No.	Part No.	Part Name & Description	Q'ty	Remarks
	R4723	EXB28V473JX	M 47KOHM 1/32 W	1	
	R4724	D0GA102JA023	M1KOHM, J.1/16 W	1	
	R4748	D0GA680JA023	M 68 OHM, J,1/16W	1	
	R4749	D0GA680JA023	M 68 OHM, J,1/16W	1	
	R4750	D0GA680JA023	M 68 OHM, J,1/16W	1	
	R4751	D0GA680JA023	M 68 OHM, J,1/16W	1	
	R4781	D0GA680JA023	M 68 OHM, J,1/16W	1	
	R4783	D0GA103JA015	M 10KOHM,J,1/16W	1	
	R4784	D0GA103JA015	M 10KOHM,J,1/16W	1	
	R4785	D0GA680JA023	M 68 OHM, J,1/16W	1	
	R4789	D0GA103JA015	M 10KOHM,J,1/16W	1	
	R4792	EXB28V473JX	M 47KOHM 1/32 W	1	
	R4793	D0GA102JA023	M1KOHM, J.1/16 W	1	
	R4798	D0GA273JA023	M 27K OHM J ,1/16W	1	
	R4802	D0GAR00J0005	M 0 OHM, 1/16W	1	
	R4814	D0GA103JA015	M 10KOHM,J,1/16W	1	
	R4910	D0GA472JA023	M 4.7KOHM, J,1/16W	1	
	R4911	D0GA102JA023	M1KOHM, J.1/16 W	1	
	R4913	D0GA103JA015	M 10KOHM,J,1/16W	1	
	R4914	EXB28V220J	M 22 OHM 1/32 W	1	
	R4921	D0GA103JA015	M 10KOHM,J,1/16W	1	
	R4970	D1BB1403A055	M 140KOHM,J.1/10W	1	
	R4971	D1BB1403A055	M 140KOHM,J.1/10W	1	
	R4972	D0GA103JA015	M 10KOHM,J,1/16W	1	
	R4973	D0GA103JA015	M 10KOHM,J,1/16W	1	
	R4974	D0GA101JA015	M 100 OHM, J,1/16W	1	
	R4975	D0GA473JA015	M 47KOHM, J,1/16W	1	
	R4976	D0GA103JA015	M 10KOHM,J,1/16W	1	
	R4978	D0GA101JA015	M 100 OHM, J,1/16W	1	
	R4979	D0GA101JA015	M 100 OHM, J,1/16W	1	
	R4984	D0GA473JA015	M 47KOHM, J,1/16W	1	
	R4985	D0GA103JA015	M 10KOHM,J,1/16W	1	
	R4987	D0GA102JA023	M1KOHM, J.1/16 W	1	
	R5000	D0GA102JA023	M1KOHM, J.1/16 W	1	
	R5001	D0GA473JA015	M 47KOHM, J,1/16W	1	
	R5009	D0GA103JA015	M 10KOHM,J,1/16W	1	
	R5010	D0GA222JA023	M 2.2KOHM, J,1/16W	1	
	R5011	D0GA104JA023	M100KOHM, J.1/16 W	1	
	R5012	D0GA223JA023	M 22K OHM J 1/16W	1	
	R5013	D0GA103JA015	M 10KOHM,J,1/16W	1	
	R5440	D0GA390JA023	M 39 OHM, J,1/16W	1	
	R5441	D1BB1002A055	M 10KOHM,J.1/10W	1	
	R5442	D1BB1002A055	M 10KOHM,J.1/10W	1	
	R5443	D1BB5362A055	M53.6KOHM,J.1/10W	1	
	R5900	D0GA390JA023	M 39 OHM, J,1/16W	1	
	R5901	D1BB1002A055	M 10KOHM,J.1/10W	1	
	R5902	D1BB5362A055	M53.6KOHM,J.1/10W	1	
	R5904	D1BB3002A055	M 30KOHM,J.1/10W	1	
	R5906	D1BA4642A014	M46.4KOHM,J.1/16 W	1	
	R5907	D0GB363JA065	M 36K OHM J 1/10W	1	
	R5910	D0GA472JA023	M 4.7KOHM, J,1/16W	1	
	R5911	D0GA472JA023	M 4.7KOHM, J,1/16W	1	
	R5912	D0GA472JA023	M 4.7KOHM, J,1/16W	1	
	R5913	D0GA472JA023	M 4.7KOHM, J,1/16W	1	
	R5916	D0GA683JA023	M 68KOHM, J,1/16W	1	
	R5917	D0GA560JA023	M 56 OHM, J,1/16W	1	
	R6701	D0GA103JA015	M 10KOHM,J,1/16W	1	
	R6702	D0GA471JA023	M 470OHM, J,1/16W	1	
	R6707	EXB28V680JX	M 68 OHM 1/32 W	1	
	R6708	EXB2HV680J	M 68 OHM 1/16 W	1	
	R6709	D0GA103JA015	M 10KOHM,J,1/16W	1	
	R6710	D0GA103JA015	M 10KOHM,J,1/16W	1	

Model No. : TX-P42UT30B/Y Parts List

Safety	Ref. No.	Part No.	Part Name & Description	Q'ty	Remarks
	R6942	D0GAR00J0005	M 0 OHM, 1/16W	1	
	R6951	D0GAR00J0005	M 0 OHM, 1/16W	1	
	R6952	D0GAR00J0005	M 0 OHM, 1/16W	1	
	R8008	D0GA331JA023	M 330 OHM, J,1/16W	1	
	R8100	D1BB1271A087	M 1.27KOHM, J,1/16W	1	
	R8102	D1BB2101A087	M 2.1KOHM, J,1/10W	1	
	R8104	D1BB8200A087	M 820 OHM, J,1/10W	1	
	R8106	D1BB2001A087	M 2KOHM, J,1/10W	1	
	R8108	D0GB100JA065	M 10 OHM J 1/10W	1	
	R8110	D0GB100JA065	M 10 OHM J 1/10W	1	
	R8114	D0GA303JA023	M 30K OHM J 0.063W	1	
	R8118	D0GA183JA023	M 18K OHM J,1/16W	1	
	R8200	D1BA2400A014	M 240 OHM, J,1/16 W	1	
	R8201	D1BA1001A014	M 1KOHM, F, 1/16 W	1	
	R8202	D1BA1001A014	M 1KOHM, F, 1/16 W	1	
	R8203	D1BA1001A014	M 1KOHM, F, 1/16 W	1	
	R8204	D1BA1001A014	M 1KOHM, F, 1/16 W	1	
	R8205	D1BA1001A014	M 1KOHM, F, 1/16 W	1	
	R8206	D1BA1001A014	M 1KOHM, F, 1/16 W	1	
	R8207	D1BA1001A014	M 1KOHM, F, 1/16 W	1	
	R8208	D1BA1001A014	M 1KOHM, F, 1/16 W	1	
	R8209	D0GA111JA023	M 110 OHM, J,1/16W	1	
	R8210	D0GA111JA023	M 110 OHM, J,1/16W	1	
	R8211	D1BA2400A014	M 240 OHM, J,1/16 W	1	
	R8212	D1BA2400A014	M 240 OHM, J,1/16 W	1	
	R8213	D0GA103JA015	M 10KOHM, J,1/16W	1	
	R8214	D0GA103JA015	M 10KOHM, J,1/16W	1	
	R8215	D1BA2400A014	M 240 OHM, J,1/16 W	1	
	R8216	D1BA1001A014	M 1KOHM, F, 1/16 W	1	
	R8217	D1BA1001A014	M 1KOHM, F, 1/16 W	1	
	R8218	EXB28V220J	M 22 OHM 1/32 W	1	
	R8219	EXB28V220J	M 22 OHM 1/32 W	1	
	R8220	EXB28V220J	M 22 OHM 1/32 W	1	
	R8221	EXB28V220J	M 22 OHM 1/32 W	1	
	R8222	EXB28V220J	M 22 OHM 1/32 W	1	
	R8223	EXB28V220J	M 22 OHM 1/32 W	1	
	R8224	EXB28V220J	M 22 OHM 1/32 W	1	
	R8225	EXB28V220J	M 22 OHM 1/32 W	1	
	R8226	EXB28V220J	M 22 OHM 1/32 W	1	
	R8227	EXB28V220J	M 22 OHM 1/32 W	1	
	R8228	EXB28V220J	M 22 OHM 1/32 W	1	
	R8229	EXB28V220J	M 22 OHM 1/32 W	1	
	R8230	D0GA220JA023	M22 OHM, J,1/16 W	1	
	R8231	D0GA220JA023	M22 OHM, J,1/16 W	1	
	R8232	D0GA220JA023	M22 OHM, J,1/16 W	1	
	R8301	D0GA471JA023	M 470OHM, J,1/16W	1	
	R8302	D0GA360JA023	M 36 OHM, J,1/16W	1	
	R8303	D0GA360JA023	M 36 OHM, J,1/16W	1	
	R8304	D1BA6201A014	M 6.2KOHM, J,1/16 W	1	
	R8305	D1BA6201A014	M 6.2KOHM, J,1/16 W	1	
	R8307	D1BA6201A014	M 6.2KOHM, J,1/16 W	1	
	R8400	D0GA680JA023	M 68 OHM, J,1/16W	1	
	R8401	D0GA680JA023	M 68 OHM, J,1/16W	1	
	R8402	D0GA680JA023	M 68 OHM, J,1/16W	1	
	R8403	D0GA680JA023	M 68 OHM, J,1/16W	1	
	R8404	D0GA680JA023	M 68 OHM, J,1/16W	1	
	R8405	D0GA680JA023	M 68 OHM, J,1/16W	1	
	R8406	EXB2HV680J	M 68 OHM 1/16 W	1	
	R8407	EXB2HV680J	M 68 OHM 1/16 W	1	
	R8408	EXB2HV680J	M 68 OHM 1/16 W	1	
	R8409	EXB28V680JX	M 68 OHM 1/32 W	1	
	R8410	EXB2HV680J	M 68 OHM 1/16 W	1	

Model No. : TX-P42UT30B/Y Parts List

Safety	Ref. No.	Part No.	Part Name & Description	Q'ty	Remarks
	R8411	EXB2HV680J	M 68 OHM 1/16 W	1	
	R8418	DOGA103JA015	M 10KOHM, J, 1/16W	1	
	R8421	EXB2HV101J	M 100 OHM 1/16 W	1	
	R8424	DOGA223JA023	M 22K OHM J 1/16W	1	
	R8425	DOGA223JA023	M 22K OHM J 1/16W	1	
	R8426	DOGA473JA015	M 47KOHM, J, 1/16W	1	
	R8427	DOGA473JA015	M 47KOHM, J, 1/16W	1	
	R8429	DOGA103JA015	M 10KOHM, J, 1/16W	1	
	R8433	DOGA103JA015	M 10KOHM, J, 1/16W	1	
	R8434	DOGA103JA015	M 10KOHM, J, 1/16W	1	
	R8435	DOGA223JA023	M 22K OHM J 1/16W	1	
	R8436	EXB2HV101J	M 100 OHM 1/16 W	1	
	R8437	EXB2HV473JV	M 47 KOHM 1/16 W	1	
	R8438	EXB2HV103JV	M 10 KOHM 1/16 W	1	
	R8440	DOGA103JA015	M 10KOHM, J, 1/16W	1	
	R8441	DOGA103JA015	M 10KOHM, J, 1/16W	1	
	R8442	DOGA103JA015	M 10KOHM, J, 1/16W	1	
	R8601	DOGA101JA015	M 100 OHM, J, 1/16W	1	
	R8602	DOGA101JA015	M 100 OHM, J, 1/16W	1	
	R8603	DOGA101JA015	M 100 OHM, J, 1/16W	1	
	R8606	DOGA472JA023	M 4.7KOHM, J, 1/16W	1	
	R8607	DOGA472JA023	M 4.7KOHM, J, 1/16W	1	
	R8608	DOGA102JA023	M1KOHM, J.1/16 W	1	
	R8609	D1BA6491A014	M6.49KOHM, J.1/16 W	1	
	R8610	DOGA221JA023	M220 OHM, J.1/16 W	1	
	R8615	DOGA105JA023	M 1M OHM, J, 1/16W	1	
	R8616	DOGA472JA023	M 4.7KOHM, J, 1/16W	1	
	R8617	DOGA103JA015	M 10KOHM, J, 1/16W	1	
	R8618	DOGA103JA015	M 10KOHM, J, 1/16W	1	
	R8620	DOGA103JA015	M 10KOHM, J, 1/16W	1	
	R8621	DOGA103JA015	M 10KOHM, J, 1/16W	1	
	R8624	DOGA560JA023	M 56 OHM, J, 1/16W	1	
	R8625	DOGA560JA023	M 56 OHM, J, 1/16W	1	
	R8626	DOGA560JA023	M 56 OHM, J, 1/16W	1	
	R8627	DOGA560JA023	M 56 OHM, J, 1/16W	1	
	R8628	DOGA560JA023	M 56 OHM, J, 1/16W	1	
	R8629	DOGA560JA023	M 56 OHM, J, 1/16W	1	
	R8630	D1HG1038A002	NETWORK RESISTER	1	
	R8632	EXB28V560JX	M 56 OHM 1/32 W	1	
	R8634	EXB28V560JX	M 56 OHM 1/32 W	1	
	R8635	EXB28V101JX	M 100 OHM 1/32 W	1	
	R8636	DOGA220JA023	M22 OHM, J.1/16 W	1	
	R8637	DOGA272JA023	M 2.7KOHM, J.1/16W	1	
	R8638	DOGA272JA023	M 2.7KOHM, J.1/16W	1	
	R8639	DOGA103JA015	M 10KOHM, J, 1/16W	1	
	R8640	DOGA103JA015	M 10KOHM, J, 1/16W	1	
	R8648	DOGA273JA023	M 27K OHM J ,1/16W	1	
	R8656	DOGA103JA015	M 10KOHM, J, 1/16W	1	
	R8661	DOGA103JA015	M 10KOHM, J, 1/16W	1	
	R8681	D1BA75R0A014	M 75 OHM, J.1/16 W	1	
	R8682	D1BA75R0A014	M 75 OHM, J.1/16 W	1	
	R8683	D1BA75R0A014	M 75 OHM, J.1/16 W	1	
	R8684	D1BA75R0A014	M 75 OHM, J.1/16 W	1	
	R8697	DOGA101JA015	M 100 OHM, J, 1/16W	1	
	R8698	DOGA101JA015	M 100 OHM, J, 1/16W	1	
	R8699	DOGA101JA015	M 100 OHM, J, 1/16W	1	
	R8716	D1BB1911A087	M1.91KOHM, J.1/16W	1	PAVCCZ
	R8718	D1BB8200A087	M 820 OHM, J.1/10W	1	
	R8720	DOGB100JA065	M 10 OHM J 1/10W	1	
	R8722	DOGA273JA023	M 27K OHM J ,1/16W	1	
	R8742	D1BB5362A055	M53.6KOHM, J.1/10W	1	
	R8743	D1BB1002A055	M 10KOHM, J.1/10W	1	

Model No. : TX-P42UT30B/Y Parts List

Safety	Ref. No.	Part No.	Part Name & Description	Q'ty	Remarks
	R8744	D0GA390JA023	M 39 OHM, J,1/16W	1	
	R8745	D1BB1002A055	M 10KOHM, J.1/10W	1	
	R8746	D0GA222JA023	M 2.2KOHM, J,1/16W	1	
	R8747	D0GA683JA023	M 68KOHM, J,1/16W	1	
	R8748	D0GA473JA015	M 47KOHM, J,1/16W	1	
	R8749	D0GA222JA023	M 2.2KOHM, J,1/16W	1	
	R8750	D0GA392JA023	M 3.9KOHM, J,1/16W	1	
	R8751	D0GA222JA023	M 2.2KOHM, J,1/16W	1	
	R8752	D0GA332JA023	M 3.3KOHM, J,1/16W	1	
	R8753	D0GA102JA023	M1KOHM, J.1/16 W	1	
	R8754	D0GA103JA015	M 10KOHM, J,1/16W	1	
	R8755	D0GA221JA023	M220 OHM, J.1/16 W	1	
	R8756	D0GA104JA023	M100KOHM, J.1/16 W	1	
	R8757	D0GD102JA052	M 1.0KOHM, J,1/8W	1	
	R8758	D0GA472JA023	M 4.7KOHM, J,1/16W	1	
	R8759	D0GA472JA023	M 4.7KOHM, J,1/16W	1	
	R8760	D0GA103JA015	M 10KOHM, J,1/16W	1	
	R8765	D0GA103JA015	M 10KOHM, J,1/16W	1	
	R8768	D0GA390JA023	M 39 OHM, J,1/16W	1	
	R8769	D1BB4301A055	M4.30KOHM, J.1/10W	1	
	R8770	D1BB3922A055	M39.2KOHM, 1/10W	1	
	R8771	D1BB1002A055	M 10KOHM, J.1/10W	1	
	R8772	D0GA472JA023	M 4.7KOHM, J,1/16W	1	
	R8773	D0GA472JA023	M 4.7KOHM, J,1/16W	1	
	R8774	D0GA563JA023	M 56KOHM, J,0.063W	1	
	R8775	D0GA473JA015	M 47KOHM, J,1/16W	1	
	R8811	D0GA103JA015	M 10KOHM, J,1/16W	1	
	R8816	D0GA103JA015	M 10KOHM, J,1/16W	1	
	R8818	D0GA103JA015	M 10KOHM, J,1/16W	1	
	R8819	D0GA103JA015	M 10KOHM, J,1/16W	1	
	R8820	D0GA103JA015	M 10KOHM, J,1/16W	1	
	R8821	D0GA473JA015	M 47KOHM, J,1/16W	1	
	R8824	D0GA103JA015	M 10KOHM, J,1/16W	1	
	R8831	D0GA103JA015	M 10KOHM, J,1/16W	1	
	R8835	D0GA103JA015	M 10KOHM, J,1/16W	1	
	R8848	D0GA102JA023	M1KOHM, J.1/16 W	1	
	R8849	D0GA103JA015	M 10KOHM, J,1/16W	1	
	R8852	D0GA243JA023	M 24K OHM J 0.063W	1	
	R8909	D0GA222JA023	M 2.2KOHM, J,1/16W	1	
	R8910	D0GA103JA015	M 10KOHM, J,1/16W	1	
	R8914	D0GA472JA023	M 4.7KOHM, J,1/16W	1	
	R8921	D0GA223JA023	M 22K OHM J 1/16W	1	
	R8964	D0GA472JA023	M 4.7KOHM, J,1/16W	1	
	R8972	EXB2HV680J	M 68 OHM 1/16 W	1	
	R9035	D0GA103JA015	M 10KOHM, J,1/16W	1	
	R9103	D0GA101JA015	M 100 OHM, J,1/16W	1	
	R9104	D0GA101JA015	M 100 OHM, J,1/16W	1	
	R9105	D0GA473JA015	M 47KOHM, J,1/16W	1	
	R9198	EXB28V101JX	M 100 OHM 1/32 W	1	
	R9203	D0GA272JA023	M 2.7KOHM, J.1/16W	1	
	R9205	D0GA333JA023	M 33KOHM, J,1/16W	1	
	R9206	D0GA563JA023	M 56KOHM, J,0.063W	1	
	R9208	EXB2HV470JV	M 47 OHM 1/16 W	1	
	R9209	EXB2HV470JV	M 47 OHM 1/16 W	1	
	R9224	D0GA470JA023	M 47 OHM, J,1/16W	1	
	R9226	D0GA470JA023	M 47 OHM, J,1/16W	1	
	R9247	D0GA470JA023	M 47 OHM, J,1/16W	1	
	R9307	D0GA330JA023	M 33 OHM, J,1/16W	1	
	R9308	D0GA330JA023	M 33 OHM, J,1/16W	1	
	R9320	D0GA182JA023	M 1.8KOHM, J,0.063W	1	
	R9321	D0GA105JA023	M 1M OHM, J,1/16W	1	
	R9324	D0GB122JA065	M 1.2KOHM J 1/10W	1	

Model No. : TX-P42UT30B/Y Parts List

Safety	Ref. No.	Part No.	Part Name & Description	Q'ty	Remarks
	R9325	D0GB122JA065	M 1.2KOHM J 1/10W	1	
	R9326	D0GB122JA065	M 1.2KOHM J 1/10W	1	
	R9327	D0GB122JA065	M 1.2KOHM J 1/10W	1	
	R9329	D0GA102JA023	M1KOHM, J.1/16 W	1	
	R9330	D0GA102JA023	M1KOHM, J.1/16 W	1	
	R9400	EXB2HV103JV	M 10 KOHM 1/16 W	1	
	R9401	EXB2HV103JV	M 10 KOHM 1/16 W	1	
	R9402	EXB28V103JX	M 10KOHM 1/32 W	1	
	R9608	EXB2HV470JV	M 47 OHM 1/16 W	1	
	R9609	EXB28V470JX	M 47 OHM 1/32 W	1	
	R9610	EXB28V470JX	M 47 OHM 1/32 W	1	
	R9611	EXB28V470JX	M 47 OHM 1/32 W	1	
	R9907	D0GA101JA015	M 100 OHM, J,1/16W	1	
	RM2810	B3RAD0000168	REMOTE SENSOR	1	
	SN2810	B3JB00000078	IC	1	
	SW2000	K0F122A00031	SWITCH	1	
	SW2001	K0H1BA000445	SWITCH	1	
	SW2002	K0H1BA000445	SWITCH	1	
	SW2003	K0H1BA000445	SWITCH	1	
	SW2004	K0H1BA000445	SWITCH	1	
	SW2005	K0H1BA000445	SWITCH	1	
	T8601	G5BYC0000015	TRANS	1	
	TU4801	ENGS7302D5F	TUNER	1	
	V14	K1KA06B00220	6P CONNECTOR	1	
	X6700	H0J410500001	CRYSTAL	1	
	X8300	H0J245500110	CRYSTAL	1	
	X8600	H0J250500109	CRYSTAL	1	
	X9300	H0J200500091	CRYSTAL	1	
	C10	K1MY20BA0345	20P CONNECTOR	1	
	C11	K1MY55BA0345	55P CONNECTOR	1	
	C14	K1KY03AA0719	3P CONNECTOR	1	
	C20	K1MY20BA0345	20P CONNECTOR	1	
	C21	K1MY55BA0345	55P CONNECTOR	1	
	C23	K1MY20BA0345	20P CONNECTOR	1	
	C25	K1KY04B00013	4P CONNECTOR	1	PAVCCZ
	C14602	F1H1C105A145	C 1 uF 16 V	1	
	C14603	F1G1H1020008	C 1000PF 50V	1	
	C14605	F1G1H391A731	C 390PF, 50V	1	
	C14606	F1G1H391A731	C 390PF, 50V	1	
	C14607	F1G1H1020008	C 1000PF 50V	1	
	C14608	F1G1H391A731	C 390PF, 50V	1	
	C14609	F1G1H391A731	C 390PF, 50V	1	
	C14612	F1H1C105A145	C 1 uF 16 V	1	
	C14616	F1H1C105A145	C 1 uF 16 V	1	
	C14620	F1H1C105A145	C 1 uF 16 V	1	
	C14629	F1H1C105A145	C 1 uF 16 V	1	
	C14633	F1H1C105A145	C 1 uF 16 V	1	
	C14651	F1L2E104A028	C 0.10UF, 250V	1	
	C14652	F1L2E104A028	C 0.10UF, 250V	1	
	C14803	F1H1C105A145	C 1 uF 16 V	1	
	C14806	F1G1H1020008	C 1000PF 50V	1	
	C14807	F1G1H391A731	C 390PF, 50V	1	
	C14808	F1G1H391A731	C 390PF, 50V	1	
	C14809	F1G1H391A731	C 390PF, 50V	1	

Model No. : TX-P42UT30B/Y Parts List

Safety	Ref. No.	Part No.	Part Name & Description	Q'ty	Remarks
	C14810	F1G1H391A731	C 390PF, 50V	1	
	C14813	F1H1C105A145	C 1 uF 16 V	1	
	C14817	F1H1C105A145	C 1 uF 16 V	1	
	C14821	F1H1C105A145	C 1 uF 16 V	1	
	C14825	F1H1C105A145	C 1 uF 16 V	1	
	C14834	F1H1C105A145	C 1 uF 16 V	1	
	C14851	F1L2E104A028	C 0.10UF, 250V	1	
	C14852	F1L2E104A028	C 0.10UF, 250V	1	
	C14902	F1H1C105A145	C 1 uF 16 V	1	
	C14903	F1H1C105A145	C 1 uF 16 V	1	
	C14904	F1H1C105A145	C 1 uF 16 V	1	
	C14905	F1G1H101A565	C 100PF 50V	1	
	C14906	F1H1C105A145	C 1 uF 16 V	1	
	C14907	F1H1C105A145	C 1 uF 16 V	1	
	C14910	F1H1C105A145	C 1 uF 16 V	1	
	C14911	F1K1E475A134	C 4.7UF 25V	1	
	C16001	F1L2J562A022	C 5600PF, 630V	1	
	C16012	F2A2E141A217	E 140UF, 250V	1	
	C16013	FOC2E155A286	C 1.5UF, 250V	1	PAVCCZ
	C16023	F1L2J1020001	C 1000PF, 630V	1	
	C16024	F1L2J332A022	C 3300PF, 630V	1	
	C16025	F1E2J222A002	C 2200PF, 630V	1	
	C16041	ECJ1VB1H392K	C 3900UF, 50V	1	
	C16044	F1E2J821A002	C 820PF, 630V	1	
	C16051	ECJ1VB1H392K	C 3900UF, 50V	1	
	C16061	F1E2J821A002	C 820PF, 630V	1	
	C16101	F1L2J222A022	C 2200PF, 630V	1	
	C16104	F1H1E470A130	C 47PF, 25V	1	
	C16105	F1H1E470A130	C 47PF, 25V	1	
	C16131	F1K1E475A134	C 4.7UF 25V	1	
	C16132	F1H1C105A145	C 1 uF 16 V	1	
	C16133	F2A1E101A089	E 100UF 25V	1	
	C16135	F1K1E105A029	C 1UF, 25V	1	
	C16153	F1K1E475A134	C 4.7UF 25V	1	
	C16154	F1K1E475A134	C 4.7UF 25V	1	
	C16191	F1K1E475A134	C 4.7UF 25V	1	
	C16192	F1H1C105A145	C 1 uF 16 V	1	
	C16193	F2A1E470B725	E 47UF, 25V	1	PAVCCZ
	C16195	F1K1E105A029	C 1UF, 25V	1	
	C16201	FOC2E405A278	C 4UF, 250V	1	PAVCCZ
	C16202	FOC2E405A278	C 4UF, 250V	1	PAVCCZ
	C16242	F1H1C105A145	C 1 uF 16 V	1	
	C16243	ECJ1VB1H103K	C 0.01UF, 50V	1	
	C16244	F1J1A106A087	C 10UF, 10V	1	
	C16271	F2A1E221B726	E 220UF, 25V	1	PAVCCZ
	C16280	F1K1E105A029	C 1UF, 25V	1	
	C16286	F1H1H104A970	C 0.1UF, , 50V	1	
	C16287	F1H1H104A970	C 0.1UF, , 50V	1	
	C16314	F2A2E141A217	E 140UF, 250V	1	
	C16315	ECJ1VB1A105K	C 1UF, 10V	1	
	C16316	ECJ1XB1C104K	C 0.1UF, Z, 16V	1	
	C16317	ECJ1VB1A105K	C 1UF, 10V	1	
	C16318	F1J1H104A717	C 0.1UF, 50V	1	
	C16319	F1J1H104A717	C 0.1UF, 50V	1	
	C16328	F2A2T1210001	E 120UF, 220V	1	PAVCCZ
	C16330	FOC2E105A286	C 1 UF 250 V	1	PAVCCZ
	C16401	F1L2J562A022	C 5600PF, 630V	1	
	C16411	F2A2E141A217	E 140UF, 250V	1	
	C16413	F2A2E141A217	E 140UF, 250V	1	
	C16421	F1L2J562A022	C 5600PF, 630V	1	
	C16441	ECJ1VB1H392K	C 3900UF, 50V	1	
	C16451	ECJ1VB1H392K	C 3900UF, 50V	1	

Model No. : TX-P42UT30B/Y Parts List

Safety	Ref. No.	Part No.	Part Name & Description	Q'ty	Remarks
	C16453	F1E2J821A002	C 820PF, 630V	1	
	C16460	F1E2J222A002	C 2200PF, 630V	1	
	C16472	ECJ1VB1A105K	C 1UF, 10V	1	
	C16490	F1H1C105A145	C 1 uF 16 V	1	
	C16502	F1K1E475A134	C 4.7UF 25V	1	
	C16503	F2A1E221B726	E 220UF, 25V	1	PAVCCZ
	C16505	F1K1E105A029	C 1UF, 25V	1	
	C16506	F1H1C105A145	C 1 uF 16 V	1	
	C16507	FOC2E155A286	C 1.5UF, 250V	1	PAVCCZ
	C16531	F1K1E475A134	C 4.7UF 25V	1	
	C16534	F1H1C105A145	C 1 uF 16 V	1	
	C16551	F1K1E475A134	C 4.7UF 25V	1	
	C16561	F1J1A106A087	C 10UF, 10V	1	
	C16562	F1H1C105A145	C 1 uF 16 V	1	
	C16564	F1H1C105A145	C 1 uF 16 V	1	
	C16565	ECJ1VB1H103K	C 0.01UF, 50V	1	
	C16566	ECJ1VB1H103K	C 0.01UF, 50V	1	
	C16567	F1H1C105A145	C 1 uF 16 V	1	
	C16584	ECJ1VB1H392K	C 3900UF, 50V	1	
	C16593	ECJ1XC1H102J	C 1000PF, J, 50V	1	
	C16602	F1H1H2200008	C 22PF, 50V	1	
	C16603	F1K2J102A014	C 1000PF, 630V	1	
	C16604	F1K2J102A014	C 1000PF, 630V	1	
	C16631	FOC2E405A278	C 4UF, 250V	1	PAVCCZ
	C16632	FOC2E405A278	C 4UF, 250V	1	PAVCCZ
	C16641	F1K2J222A014	C 2200PF ,630V	1	
	C16645	F1K2J102A014	C 1000PF, 630V	1	
	C16646	F1K2J102A014	C 1000PF, 630V	1	
	C16661	F1K2J102A038	C 1000PF, 630V	1	
	C16662	F1K2J102A038	C 1000PF, 630V	1	
	C16664	ECJ1XC1H820J	C 82PF, J, 50V	1	
	C16665	ECJ1XC1H820J	C 82PF, J, 50V	1	
	C16666	ECJ1XC1H820J	C 82PF, J, 50V	1	
	C16668	F1H1H821A831	C 820 PF, 50V	1	PAVCCZ
	C16685	F1H1H104A970	C 0.1UF, , 50V	1	
	C16692	F1H1H104A970	C 0.1UF, , 50V	1	
	C16723	F1K1E105A029	C 1UF, 25V	1	
	C16724	F1K1E475A134	C 4.7UF 25V	1	
	C16753	F1K1E475A134	C 4.7UF 25V	1	
	C16770	F1H1C105A145	C 1 uF 16 V	1	
	C16791	F2A1E221B726	E 220UF, 25V	1	PAVCCZ
	C16793	F2A1E221B726	E 220UF, 25V	1	PAVCCZ
	C16794	F1J1A106A087	C 10UF, 10V	1	
	C16795	F2A1E221B726	E 220UF, 25V	1	PAVCCZ
	C16796	F1K1E475A134	C 4.7UF 25V	1	
	C16797	F1H1H104A970	C 0.1UF, , 50V	1	
	C16813	F2A2T1210001	E 120UF, 220V	1	PAVCCZ
	C16833	F1K2J222A014	C 2200PF ,630V	1	
	C16834	F1K2J222A014	C 2200PF ,630V	1	
	C16842	F2A2C1010028	E 100UF, 160V	1	PAVCCZ
	C16843	ECJ1VB1A105K	C 1UF, 10V	1	
	C16844	F1J1H104A717	C 0.1UF, 50V	1	
	C16854	F1J1H104A717	C 0.1UF, 50V	1	
	C16856	ECJ1VB1A105K	C 1UF, 10V	1	
	C16858	ECJ1XB1C104K	C 0.1UF, Z, 16V	1	
	C16859	F1J1H104A717	C 0.1UF, 50V	1	
	C16860	ECJ1VB1A105K	C 1UF, 10V	1	
	C16861	ECJ1XB1C104K	C 0.1UF, Z, 16V	1	
	C16862	ECJ1VB1A105K	C 1UF, 10V	1	
	C16863	F1J1H104A717	C 0.1UF, 50V	1	
	C16865	F1H1C105A145	C 1 uF 16 V	1	
	C16891	F1K1E105A029	C 1UF, 25V	1	

Model No. : TX-P42UT30B/Y Parts List

Safety	Ref. No.	Part No.	Part Name & Description	Q'ty	Remarks
	C16902	F1E2J332A002	C 3300PF, 630V	1	
	C16910	F1E2J821A002	C 820PF, 630V	1	
	C16912	F1E2J821A002	C 820PF, 630V	1	
	C16914	F1L2J332A022	C 3300PF, 630V	1	
	C17101	ECJ1VB1A105K	C 1UF, 10V	1	
	C17102	ECJ1VB1A105K	C 1UF, 10V	1	
	C17103	ECJ1VB1A105K	C 1UF, 10V	1	
	C17108	F1K2A224A033	C 0.22UF, 100V	1	PAVCCZ
	C17109	F1K2A224A033	C 0.22UF, 100V	1	PAVCCZ
	C17111	F1K2A224A033	C 0.22UF, 100V	1	PAVCCZ
	C17131	ECJ1VB1A105K	C 1UF, 10V	1	
	C17132	ECJ1VB1A105K	C 1UF, 10V	1	
	C17134	F1K2A224A033	C 0.22UF, 100V	1	PAVCCZ
	C17136	F1K2A224A033	C 0.22UF, 100V	1	PAVCCZ
	C17137	ECJ1VB1A105K	C 1UF, 10V	1	
	C17138	ECJ1VB1A105K	C 1UF, 10V	1	
	C17139	F1K2A224A033	C 0.22UF, 100V	1	PAVCCZ
	C17142	F1K2A224A033	C 0.22UF, 100V	1	PAVCCZ
	C17143	ECJ1XB1C104K	C 0.1UF, Z, 16V	1	
	C17150	ECJ1XC1H102J	C 1000PF, J, 50V	1	
	C17151	ECJ1XC1H102J	C 1000PF, J, 50V	1	
	C17152	ECJ1XC1H102J	C 1000PF, J, 50V	1	
	C17153	ECJ1XC1H102J	C 1000PF, J, 50V	1	
	C17154	ECJ1XC1H102J	C 1000PF, J, 50V	1	
	C17155	ECJ1XC1H102J	C 1000PF, J, 50V	1	
	C17156	ECJ1XC1H102J	C 1000PF, J, 50V	1	
	C17157	ECJ1XC1H102J	C 1000PF, J, 50V	1	
	C17201	ECJ1VB1A105K	C 1UF, 10V	1	
	C17203	F1K2A224A033	C 0.22UF, 100V	1	PAVCCZ
	C17204	ECJ1VB1A105K	C 1UF, 10V	1	
	C17205	F1K2A224A033	C 0.22UF, 100V	1	PAVCCZ
	C17207	ECJ1VB1A105K	C 1UF, 10V	1	
	C17208	ECJ1VB1A105K	C 1UF, 10V	1	
	C17209	ECJ1VB1A105K	C 1UF, 10V	1	
	C17210	ECJ1VB1A105K	C 1UF, 10V	1	
	C17211	ECJ1VB1A105K	C 1UF, 10V	1	
	C17212	ECJ1VB1A105K	C 1UF, 10V	1	
	C17213	ECJ1XB1C104K	C 0.1UF, Z, 16V	1	
	C17214	ECJ1XB1C104K	C 0.1UF, Z, 16V	1	
	C17226	F1K2A224A033	C 0.22UF, 100V	1	PAVCCZ
	C17229	F1K2A224A033	C 0.22UF, 100V	1	PAVCCZ
	C17230	F1K2A224A033	C 0.22UF, 100V	1	PAVCCZ
	C17233	F1K2A224A033	C 0.22UF, 100V	1	PAVCCZ
	C17235	F1K2A224A033	C 0.22UF, 100V	1	PAVCCZ
	C17236	F1K2A224A033	C 0.22UF, 100V	1	PAVCCZ
	C17239	ECJ1XC1H102J	C 1000PF, J, 50V	1	
	C17240	ECJ1XC1H102J	C 1000PF, J, 50V	1	
	C17241	ECJ1XC1H102J	C 1000PF, J, 50V	1	
	C17242	ECJ1XC1H102J	C 1000PF, J, 50V	1	
	C17243	ECJ1XC1H102J	C 1000PF, J, 50V	1	
	C17244	ECJ1XC1H102J	C 1000PF, J, 50V	1	
	C17245	ECJ1XC1H102J	C 1000PF, J, 50V	1	
	C17246	ECJ1XC1H102J	C 1000PF, J, 50V	1	
	CB1	K1MY55B00002	55P CONNECTOR	1	
	CB2	K1MY55B00002	55P CONNECTOR	1	
	CB3	K1MY55B00002	55P CONNECTOR	1	
	CB4	K1MY55B00002	55P CONNECTOR	1	
	CB5	K1MY55B00002	55P CONNECTOR	1	
	CB6	K1MY55B00002	55P CONNECTOR	1	
	CB7	K1MY55B00002	55P CONNECTOR	1	
	CB8	K1MY55B00002	55P CONNECTOR	1	

Model No. : TX-P42UT30B/Y Parts List

Safety	Ref. No.	Part No.	Part Name & Description	Q'ty	Remarks
	CB9	K1MY55B00002	55P CONNECTOR	1	
	CB10	K1MY55B00002	55P CONNECTOR	1	
	CB11	K1MY55B00002	55P CONNECTOR	1	
	CB12	K1MY55B00002	55P CONNECTOR	1	
	CB13	K1MY55B00002	55P CONNECTOR	1	
	CB14	K1MY55B00002	55P CONNECTOR	1	
	CB15	K1MY55B00002	55P CONNECTOR	1	
	D14652	B0ECKM000046	DIODE	1	
	D14654	B0ECKM000046	DIODE	1	
	D14703	B0ADCJ000100	DIODE	1	
	D14852	B0ECKM000046	DIODE	1	
	D14853	B0ECKM000046	DIODE	1	
	D14902	B0ACCCJ000048	DIODE	1	
	D14903	B0ACCCJ000048	DIODE	1	
	D14904	B0ADCJ000100	DIODE	1	
	D16001	B0ECLP000010	DIODE	1	PAVCCZ
	D16002	B0ECLP000010	DIODE	1	PAVCCZ
	D16021	B0ECLP000010	DIODE	1	PAVCCZ
	D16022	DA3CF30ACL	ZENER DIODE	1	PAVCCZ
	D16041	B0FCCN000003	DIODE	1	
	D16051	B0FCCN000003	DIODE	1	
	D16071	B0ECLP000010	DIODE	1	PAVCCZ
	D16072	B0ECKP000055	DIODE	1	
	D16073	B0ECKP000055	DIODE	1	
	D16131	B0ECKP000055	DIODE	1	
	D16133	B0ACCCJ000048	DIODE	1	
	D16134	DZ2J051M0L	ZENER DIODE	1	
	D16191	B0ECKP000055	DIODE	1	
	D16192	B0ACCCJ000048	DIODE	1	
	D16193	DZ2J051M0L	ZENER DIODE	1	
	D16243	B0ADCJ000100	DIODE	1	
	D16251	DZ2J330M0L	ZENER DIODE	1	
	D16252	DZ2J330M0L	ZENER DIODE	1	
	D16253	DZ2J051M0L	ZENER DIODE	1	
	D16254	B3ABB0000210	LED	1	
	D16255	B0ADCJ000100	DIODE	1	
	D16282	DZ2J068M0L	ZENER DIODE	1	
	D16285	B0ADEJ000035	ZENER DIODE	1	
	D16315	DZ2J150M0L	ZENER DIODE	1	
	D16316	B0ECKP000055	DIODE	1	
	D16317	B0ECKP000055	DIODE	1	
	D16401	B0FCCN000003	DIODE	1	
	D16407	B0JCME000093	DIODE	1	
	D16411	B0ADCJ000100	DIODE	1	
	D16413	B0ACCCJ000048	DIODE	1	
	D16421	B0FCBN000001	DIODE	1	PAVCCZ
	D16432	B0ECKP000055	DIODE	1	
	D16433	B0ECKP000055	DIODE	1	
	D16461	B0FCCN000003	DIODE	1	
	D16473	B0ACCCJ000048	DIODE	1	
	D16474	B0ACCCJ000048	DIODE	1	
	D16481	B0FCCN000003	DIODE	1	
	D16491	B0ACCCJ000048	DIODE	1	
	D16492	DZ2J047M0L	ZENER DIODE	1	
	D16493	B0ADCJ000100	DIODE	1	
	D16506	DZ2J051M0L	ZENER DIODE	1	
	D16534	DZ2J051M0L	ZENER DIODE	1	
	D16536	B0ECKP000055	DIODE	1	
	D16537	B0ADCJ000100	DIODE	1	
	D16538	B0ADCJ000100	DIODE	1	
	D16581	DZ2J330M0L	ZENER DIODE	1	

Model No. : TX-P42UT30B/Y Parts List

Safety	Ref. No.	Part No.	Part Name & Description	Q'ty	Remarks
	D16582	DZ2J330M0L	ZENER DIODE	1	
	D16583	B3ABB0000210	LED	1	
	D16602	DZ2J043M0L	ZENER DIODE	1	
	D16603	B0ACCJ000048	DIODE	1	
	D16604	B0ADCJ000100	DIODE	1	
	D16605	B0ACCJ000048	DIODE	1	
	D16607	B0ACCJ000048	DIODE	1	
	D16608	B0ECKP000055	DIODE	1	
	D16609	B0ECKP000055	DIODE	1	
	D16618	B0ECKP000055	DIODE	1	
	D16641	B0FCCN000004	DIODE	1	PAVCCZ
	D16642	B0FCCN000004	DIODE	1	PAVCCZ
	D16645	DZ2J150M0L	ZENER DIODE	1	
	D16646	DZ2J150M0L	ZENER DIODE	1	
	D16647	DZ2J150M0L	ZENER DIODE	1	
	D16648	DZ2J043M0L	ZENER DIODE	1	
	D16651	DZ2J051M0L	ZENER DIODE	1	
	D16652	B0ECKP000055	DIODE	1	
	D16662	DZ2J150M0L	ZENER DIODE	1	
	D16663	DZ2J150M0L	ZENER DIODE	1	
	D16664	DZ2J150M0L	ZENER DIODE	1	
	D16669	B0ACCJ000048	DIODE	1	
	D16673	B0ECHR000004	DIODE	1	PAVCCZ
	D16674	B0ECHR000004	DIODE	1	PAVCCZ
	D16685	B0ACCJ000048	DIODE	1	
	D16710	DZ2J15000L	ZENER DIODE	1	
	D16711	B0ECHR000004	DIODE	1	PAVCCZ
	D16712	B0ECHR000004	DIODE	1	PAVCCZ
	D16713	B0ECHS000002	DIODE	1	PAVCCZ
	D16714	B0ECHS000002	DIODE	1	PAVCCZ
	D16720	B0ECHR000004	DIODE	1	PAVCCZ
	D16728	B0ECKP000055	DIODE	1	
	D16791	DZ2J240M0L	ZENER DIODE	1	
	D16792	B0ACCJ000048	DIODE	1	
	D16795	B0ACCJ000048	DIODE	1	
	D16822	B0ACCJ000048	DIODE	1	
	D16823	B0ADCJ000100	DIODE	1	
	D16824	B0ACCJ000048	DIODE	1	
	D16825	DZ2J330M0L	ZENER DIODE	1	
	D16833	B0ECHR000004	DIODE	1	PAVCCZ
	D17101	B0ACCJ000048	DIODE	1	
	D17102	B0ACCJ000048	DIODE	1	
	D17103	B0JCCD000020	DIODE	1	PAVCCZ
	D17201	B0ACCJ000048	DIODE	1	
	D17202	B0ACCJ000048	DIODE	1	
	D17203	B0JCCD000020	DIODE	1	PAVCCZ
	IC14601	AN16520A-VT	IC	1	PAVCCZ
	IC14602	AN16520A-VT	IC	1	PAVCCZ
	IC14603	AN16520A-VT	IC	1	PAVCCZ
	IC14604	AN16520A-VT	IC	1	PAVCCZ
	IC14605	AN16520A-VT	IC	1	PAVCCZ
	IC14606	AN16520A-VT	IC	1	PAVCCZ
	IC14801	AN16520A-VT	IC	1	PAVCCZ
	IC14802	AN16520A-VT	IC	1	PAVCCZ
	IC14803	AN16520A-VT	IC	1	PAVCCZ
	IC14804	AN16520A-VT	IC	1	PAVCCZ
	IC14805	AN16520A-VT	IC	1	PAVCCZ
	IC14806	AN16520A-VT	IC	1	PAVCCZ
	IC14901	C0JBAB000996	IC	1	PAVCCZ
	IC14902	C0JBAB000996	IC	1	PAVCCZ
	IC14904	C0JBAA000557	IC	1	PAVCCZ

Model No. : TX-P42UT30B/Y Parts List

Safety	Ref. No.	Part No.	Part Name & Description	Q'ty	Remarks
	IC16131	C0ZBZ0001822	IC	1	PAVCCZ
	IC16132	C0ZBZ0001822	IC	1	PAVCCZ
	IC16151	C0ZBZ0001822	IC	1	PAVCCZ
	IC16152	C0ZBZ0001822	IC	1	PAVCCZ
	IC16191	C0ZBZ0001822	IC	1	PAVCCZ
	IC16241	C0JBAU000088	IC	1	
	IC16243	C0JBAB000715	IC	1	
	IC16244	C0JBAA000558	IC	1	PAVCCZ
	IC16304	MIP3910MSSCF	IC	1	
	IC16312	C0DBZMC00006	IC	1	
	IC16471	C0DBEYY00114	IC	1	
	IC16490	C0DBZMC00006	IC	1	
	IC16491	C0BBAA000008	LINEAR IC	1	
	IC16501	C0ZBZ0001822	IC	1	PAVCCZ
	IC16502	C0ZBZ0001822	IC	1	PAVCCZ
	IC16521	C0ZBZ0001822	IC	1	PAVCCZ
	IC16522	C0ZBZ0001822	IC	1	PAVCCZ
	IC16561	C0JBAU000088	IC	1	
	IC16562	C0JBAU000088	IC	1	
	IC16563	C0JBAB000996	IC	1	PAVCCZ
	IC16564	C0JBAE000321	IC	1	
	IC16565	C0JBAE000321	IC	1	
	IC16684	C0ZBZ0001822	IC	1	PAVCCZ
	IC16691	C0JBAC000509	IC	1	PAVCCZ
	IC16724	C0CBADE00049	IC	1	
	IC16784	MIP3910MSSCF	IC	1	
	IC16785	C0DBZYY00352	IC	1	
	IC16786	MIP3910MSSCF	IC	1	
	IC16787	C0DBZYY00352	IC	1	
	IC16792	C0BBAA000008	LINEAR IC	1	
	IC16793	C0DBZMC00006	IC	1	
	IC16795	C0CBALC00012	IC	1	
	IC16921	C1ZBZ0004292	IC	1	PAVCCZ
	IC17102	C0JBAU000088	IC	1	
	IC17201	C0JBAU000088	IC	1	
	IC17202	C0JBAU000089	IC	1	PAVCCZ
	L16001	G0CR46KA0216	PEAKING COIL	1	PAVCCZ
	L16303	G0C471MA0049	PEAKING COIL	1	
	L16411	G0CR43KA0216	PEAKING COIL	1	PAVCCZ
	PC14901	B3PBE0000059	IC	1	PAVCCZ
	PC14902	B3PBE0000059	IC	1	PAVCCZ
	PC14903	B3PBE0000050	IC	1	
	PC16131	B3PBE0000058	IC	1	PAVCCZ
	PC16191	B3PBE0000060	IC	1	PAVCCZ
	PC16251	B3PBA0000580	IC	1	PAVCCZ
	PC16301	B3PBA0000580	IC	1	PAVCCZ
	PC16461	B3PBE0000058	IC	1	PAVCCZ
	PC16462	B3PBE0000060	IC	1	PAVCCZ
	PC16480	B3PBA0000580	IC	1	PAVCCZ
	PC16581	B3PBA0000580	IC	1	PAVCCZ
	PC16603	B3PBA0000580	IC	1	PAVCCZ
	PC16685	B3PBA0000496	IC	1	
	PC16723	B3PBA0000580	IC	1	PAVCCZ
	PC16896	B3PBA0000580	IC	1	PAVCCZ
	PC16897	B3PBA0000580	IC	1	PAVCCZ
	Q16001	DG3C3010CL	TRANSISTOR	1	PAVCCZ
	Q16002	DG3C3010CL	TRANSISTOR	1	PAVCCZ
	Q16021	DG3C3010CL	TRANSISTOR	1	PAVCCZ
	Q16022	DG3C3010CL	TRANSISTOR	1	PAVCCZ

Model No. : TX-P42UT30B/Y Parts List

Safety	Ref. No.	Part No.	Part Name & Description	Q'ty	Remarks
	Q16041	DG3C3020CL	TRANSISTOR	1	PAVCCZ
	Q16051	DG3C3020CL	TRANSISTOR	1	PAVCCZ
	Q16055	B1HFPPA00001	TRANSISTOR	1	
	Q16056	B1HFPPA00001	TRANSISTOR	1	
	Q16101	B1CFRM000015	FET	1	
	Q16102	B1CFRM000023	FET	1	PAVCCZ
	Q16141	B1HFPPA00001	TRANSISTOR	1	
	Q16161	B1HFPPA00001	TRANSISTOR	1	
	Q16251	B1ABCF000231	TRANSISTOR	1	
	Q16280	B1ABCE000015	TRANSISTOR	1	
	Q16401	B1JBDN000004	TRANSISTOR	1	PAVCCZ
	Q16402	B1JBDN000004	TRANSISTOR	1	PAVCCZ
	Q16421	B1JBDN000004	TRANSISTOR	1	PAVCCZ
	Q16422	B1JBDN000004	TRANSISTOR	1	PAVCCZ
	Q16441	DG3C3020CL	TRANSISTOR	1	PAVCCZ
	Q16451	DG3C3020CL	TRANSISTOR	1	PAVCCZ
	Q16471	B1ABCE000015	TRANSISTOR	1	
	Q16501	B1HFPPA00001	TRANSISTOR	1	
	Q16521	B1HFPPA00001	TRANSISTOR	1	
	Q16531	B1HFPPA00001	TRANSISTOR	1	
	Q16538	B1CBGD000001	FET	1	
	Q16551	B1HFPPA00001	TRANSISTOR	1	
	Q16581	B1ABCF000231	TRANSISTOR	1	
	Q16600	B1CFRM000020	FET	1	PAVCCZ
	Q16601	B1CFRQ000021	FET	1	PAVCCZ
	Q16602	DSA2001SOL	TRANSISTOR	1	
	Q16606	DSC2001SOL	TRANSISTOR	1	
	Q16607	B1CBGD000001	FET	1	
	Q16621	B1JBDN000004	TRANSISTOR	1	PAVCCZ
	Q16622	B1JBDN000004	TRANSISTOR	1	PAVCCZ
	Q16646	DSA2001SOL	TRANSISTOR	1	
	Q16647	B1CBGD000001	FET	1	
	Q16660	B1CFRQ000021	FET	1	PAVCCZ
	Q16661	B1JBER000002	TRANSISTOR	1	PAVCCZ
	Q16762	B1HFPPA00001	TRANSISTOR	1	
	Q16815	B1ABCN000007	TRANSISTOR	1	
	Q16817	DSC2001QOL	TRANSISTOR	1	
	Q16818	B1CBGD000001	FET	1	
	Q16819	B1CBGD000001	FET	1	
	Q16820	B1CBGD000001	FET	1	
	Q16891	DSA2001SOL	TRANSISTOR	1	
	Q16892	DSC2001QOL	TRANSISTOR	1	
	Q16921	B1CBGD000001	FET	1	
	Q16922	B1CBGD000001	FET	1	
	Q16931	B1ABCN000007	TRANSISTOR	1	
	Q17101	B1ABCN000007	TRANSISTOR	1	
	Q17201	B1ABCN000007	TRANSISTOR	1	
	R14604	D0GD220JA052	M 22 OHM, J, 1/4W	1	PAVCCZ
	R14605	D0GB103JA065	M 10K OHM J 1/10W	1	
	R14901	D0GD331JA052	M 330 OHM, J, 1/4W	1	PAVCCZ
	R14902	D0GD331JA052	M 330 OHM, J, 1/4W	1	PAVCCZ
	R14904	D0GD3R3JA052	M 3.3 OHM, J, 1/4W	1	PAVCCZ
	R14907	D0GD331JA052	M 330 OHM, J, 1/4W	1	PAVCCZ
	R14908	D0GD331JA052	M 330 OHM, J, 1/4W	1	PAVCCZ
	R14911	D0GD181JA052	M 180 OHM, J, 1/4W	1	PAVCCZ
	R14913	D0GD102JA052	M 1.0KOHM, J, 1/8W	1	PAVCCZ
	R14916	EXB38V473J	M 47 KOHM 1/16 W	1	
	R14917	D0GD203JA052	M 20KOHM, J, 1/4W	1	PAVCCZ
	R14918	D0GD100JA052	M 10 OHM, J, 1/4W	1	
	R14919	D0GB103JA065	M 10K OHM J 1/10W	1	
	R14920	D0GD470JA052	M 47 OHM, J, 1/8W	1	PAVCCZ

Model No. : TX-P42UT30B/Y Parts List

Safety	Ref. No.	Part No.	Part Name & Description	Q'ty	Remarks
	R14921	EXB38V220JV	M 22 OHM 1/16 W	1	
	R14922	EXB38V220JV	M 22 OHM 1/16 W	1	
	R14923	EXB38V220JV	M 22 OHM 1/16 W	1	
	R14930	D0GB220JA065	M 22 OHM J 1/10W	1	PAVCCZ
	R14966	EXB38V222J	M 2.2 KOHM 1/16 W	1	
	R16001	D0GF7R5JA047	M 7.5 OHM, J, 1/3W	1	
	R16002	D0GF7R5JA047	M 7.5 OHM, J, 1/3W	1	
	R16021	D0GF7R5JA047	M 7.5 OHM, J, 1/3W	1	
	R16022	D0GF7R5JA047	M 7.5 OHM, J, 1/3W	1	
	R16031	D0GF473JA048	M 47KOHM, J, 1/3W	1	PAVCCZ
	R16032	D0GF473JA048	M 47KOHM, J, 1/3W	1	PAVCCZ
	R16041	D0GF5R6JA047	M 5.6 OHM, J, 1/3W	1	
	R16051	D0GF5R6JA047	M 5.6 OHM, J, 1/3W	1	
	R16101	D0GD150JA059	M 15 OHM, J, 1/4W	1	
	R16102	D0GD150JA059	M 15 OHM, J, 1/4W	1	
	R16105	D0GF474JA048	M 470KOHM, J, 1/3W	1	PAVCCZ
	R16116	D0GB473JA065	M 47KOHM J. 1/10W	1	PAVCCZ
	R16130	D0GB103JA065	M 10K OHM J 1/10W	1	
	R16131	D0GB220JA065	M 22 OHM J 1/10W	1	PAVCCZ
	R16132	D0GB101JA065	M 100 OHM, J, 1/10W	1	
	R16133	D1BD2700A044	M 270 OHM, J, 1/8 W	1	
	R16134	D0GD750JA059	M 75 OHM, J, 1/4W	1	
	R16135	D0GB4R7JA065	M 4.7 OHM J 1/10W	1	PAVCCZ
	R16137	D0GZ1R0JA020	M 1 OHM, J, 1/2W	1	
	R16138	D0GF561JA047	M 560 OHM, J, 1/3W	1	PAVCCZ
	R16141	D0GD100JA059	M 10 OHM, J, 1/4W	1	
	R16143	D0GB473JA065	M 47KOHM J. 1/10W	1	PAVCCZ
	R16151	D0GB220JA065	M 22 OHM J 1/10W	1	PAVCCZ
	R16152	D0GB220JA065	M 22 OHM J 1/10W	1	PAVCCZ
	R16153	D0GB331JA065	M330 OHM J 1/10W	1	PAVCCZ
	R16154	D0GD750JA059	M 75 OHM, J, 1/4W	1	
	R16155	D0GB4R7JA065	M 4.7 OHM J 1/10W	1	PAVCCZ
	R16161	D0GD100JA059	M 10 OHM, J, 1/4W	1	
	R16163	D0GB473JA065	M 47KOHM J. 1/10W	1	PAVCCZ
	R16171	D0GD100JA059	M 10 OHM, J, 1/4W	1	
	R16173	D0GB473JA065	M 47KOHM J. 1/10W	1	PAVCCZ
	R16181	D0GD100JA059	M 10 OHM, J, 1/4W	1	
	R16183	D0GB473JA065	M 47KOHM J. 1/10W	1	PAVCCZ
	R16191	D1BD2700A044	M 270 OHM, J, 1/8 W	1	
	R16192	D0GB103JA065	M 10K OHM J 1/10W	1	
	R16193	D0GD750JA052	M 75 OHM, J, 1/8W	1	PAVCCZ
	R16195	D0GF1R0JA047	M 1 OHM, J, 1/3W	1	
	R16196	D0GF102JA048	M 1.0 KOHM, J, 1/3W	1	PAVCCZ
	R16197	D0GB220JA065	M 22 OHM J 1/10W	1	PAVCCZ
	R16230	D0GD470JA052	M 47 OHM, J, 1/8W	1	PAVCCZ
	R16231	D0GB472JA065	M 4.7KOHM, J, 1/10W	1	
	R16241	EXB38V470J	M 47 OHM 1/16 W	1	
	R16242	EXB38V472JV	M 4.7 KOHM 1/16 W	1	
	R16243	D0GB103JA065	M 10K OHM J 1/10W	1	
	R16244	D0GB273JA065	M 27K OHM J 1/10W	1	PAVCCZ
	R16245	D0GB472JA065	M 4.7KOHM, J, 1/10W	1	
	R16246	D0GD222JA052	M 2.2KOHM, J, 1/8W	1	PAVCCZ
	R16252	D0GF563JA048	M 56 KOHM, J, 1/3W	1	PAVCCZ
	R16253	D1BD1003A044	M 100KOHM, J, 1/8 W	1	
	R16254	D1BD4422A044	M44.2KOHM, F, 1/8W	1	PAVCCZ
	R16255	D0GB103JA065	M 10K OHM J 1/10W	1	
	R16257	D0GB473JA065	M 47KOHM J. 1/10W	1	PAVCCZ
	R16281	D0GB103JA065	M 10K OHM J 1/10W	1	
	R16282	D0GD221JA052	M 220 OHM, J 1/4W	1	PAVCCZ
	R16283	D0GB473JA065	M 47KOHM J. 1/10W	1	PAVCCZ
	R16284	D0GB224JA065	M 220KOHM, J, 1/10W	1	PAVCCZ
	R16285	EXB38V623J	M 62 KOHM 1/16 W	1	

Model No. : TX-P42UT30B/Y Parts List

Safety	Ref. No.	Part No.	Part Name & Description	Q'ty	Remarks
	R16289	D0GF334JA047	M 330KOHMJ,1/3W	1	
	R16290	D0GF334JA047	M 330KOHMJ,1/3W	1	
	R16307	D1BD5232A077	M52.3KOHM,D.1/10W	1	PAVCCZ
	R16309	ERG2FJS473D	M 47KOHM, J, 2W	1	
	R16310	ERG2FJS473D	M 47KOHM, J, 2W	1	
	R16311	ERG2FJS473D	M 47KOHM, J, 2W	1	
	R16317	D1BD5232A077	M52.3KOHM,D.1/10W	1	PAVCCZ
	R16318	D1BD4752A077	M47.5KOHM,D.1/10W	1	PAVCCZ
	R16319	D1BD2491A077	M 2.49KOHM,D.1/10W	1	PAVCCZ
	R16320	ERJ14YJ683	M 68KOHM, J. 1/4W	1	
	R16330	D0GB102JA065	M 1KOHM, J,1/10W	1	
	R16332	D0GB474JA065	M 470KOHM, J,1/10W	1	
	R16334	D0GB472JA065	M 4.7KOHM, J,1/10W	1	
	R16335	D0GB102JA065	M 1KOHM, J,1/10W	1	
	R16401	D0GF7R5JA047	M 7.5 OHM, J, 1/3W	1	
	R16402	D0GF7R5JA047	M 7.5 OHM, J, 1/3W	1	
	R16411	D1BD2700A044	M 270 OHM, J.1/8 W	1	
	R16412	D1BD2700A044	M 270 OHM, J.1/8 W	1	
	R16414	D0GB103JA065	M 10K OHM J 1/10W	1	
	R16416	D0GB103JA065	M 10K OHM J 1/10W	1	
	R16421	D0GF7R5JA047	M 7.5 OHM, J, 1/3W	1	
	R16422	D0GF7R5JA047	M 7.5 OHM, J, 1/3W	1	
	R16441	D0GF5R6JA047	M 5.6 OHM, J, 1/3W	1	
	R16451	D0GF5R6JA047	M 5.6 OHM, J, 1/3W	1	
	R16466	D0GF473JA048	M 47KOHM, J,1/3W	1	PAVCCZ
	R16467	D0GF473JA048	M 47KOHM, J,1/3W	1	PAVCCZ
	R16471	D0GB392JA065	M 3.9KOHM, J,1/10W	1	PAVCCZ
	R16472	D0GB222JA065	M 2.2KOHM, J,1/10W	1	
	R16473	D0GD561JA052	M 560 OHM, J,1/4W	1	PAVCCZ
	R16474	D0GB102JA065	M 1KOHM, J,1/10W	1	
	R16475	D0GB472JA065	M 4.7KOHM, J,1/10W	1	
	R16476	D0GB222JA065	M 2.2KOHM, J,1/10W	1	
	R16479	D0GD103JA052	M 10KOHM, J,1/8W	1	PAVCCZ
	R16490	D1BD1203A077	M 120KOHM,D.1/10W	1	PAVCCZ
	R16491	D1BD1203A077	M 120KOHM,D.1/10W	1	PAVCCZ
	R16492	D1BD1203A077	M 120KOHM,D.1/10W	1	PAVCCZ
	R16493	D1BD5111A077	M5.11KOHM.J.1/8 W	1	PAVCCZ
	R16494	D1BB2001A055	M 2KOHM, J.1/10W	1	
	R16497	D0GB473JA065	M 47KOHM J. 1/10W	1	PAVCCZ
	R16498	D0GB103JA065	M 10K OHM J 1/10W	1	
	R16501	D0GB220JA065	M 22 OHM J 1/10W	1	PAVCCZ
	R16503	D0GD100JA059	M 10 OHM, J,1/4W	1	
	R16505	D0GF102JA048	M 1.0 KOHM, J,1/3W	1	PAVCCZ
	R16506	D0GD100JA059	M 10 OHM, J,1/4W	1	
	R16507	D0GB220JA065	M 22 OHM J 1/10W	1	PAVCCZ
	R16508	D0GB220JA065	M 22 OHM J 1/10W	1	PAVCCZ
	R16512	D0GB473JA065	M 47KOHM J. 1/10W	1	PAVCCZ
	R16515	D0D52R2KA005	M 2.2 OHM, J, 5W	1	PAVCCZ
	R16517	D0GB473JA065	M 47KOHM J. 1/10W	1	PAVCCZ
	R16522	D0GB101JA065	M 100 OHM, J,1/10W	1	
	R16525	D0GB4R7JA065	M 4.7 OHM J 1/10W	1	PAVCCZ
	R16526	D0GB4R7JA065	M 4.7 OHM J 1/10W	1	PAVCCZ
	R16531	D0GD100JA059	M 10 OHM, J,1/4W	1	
	R16532	D0GB473JA065	M 47KOHM J. 1/10W	1	PAVCCZ
	R16534	D0GF561JA047	M 560 OHM, J, 1/3W	1	PAVCCZ
	R16536	D0GF1R0JA047	M 1 OHM, J,1/3W	1	
	R16537	D0GF1R0JA047	M 1 OHM, J,1/3W	1	
	R16551	D0GD100JA059	M 10 OHM, J,1/4W	1	
	R16552	D0GB473JA065	M 47KOHM J. 1/10W	1	PAVCCZ
	R16561	EXB38V470J	M 47 OHM 1/16 W	1	
	R16562	EXB38V470J	M 47 OHM 1/16 W	1	
	R16563	EXB38V470J	M 47 OHM 1/16 W	1	

Model No. : TX-P42UT30B/Y Parts List

Safety	Ref. No.	Part No.	Part Name & Description	Q'ty	Remarks
	R16564	EXB38V470J	M 47 OHM 1/16 W	1	
	R16565	EXB38V472JV	M 4.7 kOHM 1/16 W	1	
	R16566	EXB38V472JV	M 4.7 kOHM 1/16 W	1	
	R16567	EXB38V472JV	M 4.7 kOHM 1/16 W	1	
	R16568	EXB38V472JV	M 4.7 kOHM 1/16 W	1	
	R16570	EXB38V472JV	M 4.7 kOHM 1/16 W	1	
	R16573	D0GB103JA065	M 10K OHM J 1/10W	1	
	R16574	D0GB103JA065	M 10K OHM J 1/10W	1	
	R16575	D0GB751JA065	M750 OHM J 1/10W	1	PAVCCZ
	R16576	D0GB101JA065	M 100 OHM, J, 1/10W	1	
	R16579	EXB38V470J	M 47 OHM 1/16 W	1	
	R16581	D0GB103JA065	M 10K OHM J 1/10W	1	
	R16582	D0GF563JA048	M 56 KOHM, J, 1/3W	1	PAVCCZ
	R16583	D1BD1003A044	M 100KOHM, J, 1/8 W	1	
	R16584	D1BD4422A044	M44.2KOHM, F, 1/8W	1	PAVCCZ
	R16585	D0GB473JA065	M 47KOHM J. 1/10W	1	PAVCCZ
	R16587	D0GB222JA065	M 2.2KOHM, J, 1/10W	1	
	R16588	D0GB223JA065	M 22KOHM, J, 1/10W	1	PAVCCZ
	R16590	D0GB221JA065	M 220 OHM J 1/10W	1	
	R16591	EXB38V472JV	M 4.7 kOHM 1/16 W	1	
	R16594	D0GB472JA065	M 4.7KOHM, J, 1/10W	1	
	R16601	D0GF1R0JA047	M 1 OHM, J, 1/3W	1	
	R16604	D0GD331JA052	M 330 OHM, J, 1/4W	1	PAVCCZ
	R16605	D0GD220JA059	M 22 OHM, J, 1/4W	1	PAVCCZ
	R16606	D0GD223JA052	M 22KOHM, J, 1/4W	1	PAVCCZ
	R16607	D1BB5111A055	M5.11KOHM, J. 1/10W	1	
	R16608	ERG2FJS153D	M 15KOHM, J, 2W	1	
	R16609	D0GF102JA047	M 1.0 KOHM, J, 1/3W	1	
	R16610	D0GB104JA065	M 100KOHM J 1/10W	1	
	R16612	D0GD220JA059	M 22 OHM, J, 1/4W	1	PAVCCZ
	R16615	D1BB1871A055	M1.87KOHM, 1/10W	1	PAVCCZ
	R16617	D0GD222JA052	M 2.2KOHM, J, 1/8W	1	PAVCCZ
	R16621	D0GD221JA052	M 220 OHM, J 1/4W	1	PAVCCZ
	R16622	D0GD221JA052	M 220 OHM, J 1/4W	1	PAVCCZ
	R16631	D0GB103JA065	M 10K OHM J 1/10W	1	
	R16633	D0GD223JA052	M 22KOHM, J, 1/4W	1	PAVCCZ
	R16634	D0GD222JA052	M 2.2KOHM, J, 1/8W	1	PAVCCZ
	R16645	D0GB562JA065	M 5.6KOHM, J, 1/10W	1	PAVCCZ
	R16646	D1BD8660A044	M 866 OHM, F, 1/8W	1	PAVCCZ
	R16648	D0GF102JA047	M 1.0 KOHM, J, 1/3W	1	
	R16649	D0GD330JA059	M 33 OHM, F, 1/4W	1	
	R16650	D0GB104JA065	M 100KOHM J 1/10W	1	
	R16653	D0GD222JA052	M 2.2KOHM, J, 1/8W	1	PAVCCZ
	R16654	D0GD470JA052	M 47 OHM, J, 1/8W	1	PAVCCZ
	R16658	D1BD6491A077	M6.49KOHM, D. 1/10W	1	PAVCCZ
	R16661	D0GD100JA059	M 10 OHM, J, 1/4W	1	
	R16662	D1BB1002A087	M 10KOHM, J, 1/10W	1	
	R16663	D1BD9091A077	M 9.09KOHM, D, 1/10W	1	PAVCCZ
	R16664	D0GF102JA047	M 1.0 KOHM, J, 1/3W	1	
	R16665	D0GD222JA052	M 2.2KOHM, J, 1/8W	1	PAVCCZ
	R16666	D1BB1003A087	M100KOHM, D 1/10W	1	PAVCCZ
	R16668	D0GF102JA047	M 1.0 KOHM, J, 1/3W	1	
	R16675	D0GB103JA065	M 10K OHM J 1/10W	1	
	R16676	D1BD2700A044	M 270 OHM, J, 1/8 W	1	
	R16678	D0GF102JA047	M 1.0 KOHM, J, 1/3W	1	
	R16681	D0GD100JA059	M 10 OHM, J, 1/4W	1	
	R16682	D0GD100JA059	M 10 OHM, J, 1/4W	1	
	R16684	D0GB220JA065	M 22 OHM J 1/10W	1	PAVCCZ
	R16685	D1BD1500A044	M 150 OHM, J, 1/8 W	1	
	R16686	D0GB103JA065	M 10K OHM J 1/10W	1	
	R16761	D0GD100JA059	M 10 OHM, J, 1/4W	1	
	R16763	D0GB473JA065	M 47KOHM J. 1/10W	1	PAVCCZ

Model No. : TX-P42UT30B/Y Parts List

Safety	Ref. No.	Part No.	Part Name & Description	Q'ty	Remarks
	R16772	D0GB472JA065	M 4.7KOHM, J, 1/10W	1	
	R16773	D0GD102JA052	M 1.0KOHM, J, 1/8W	1	PAVCCZ
	R16776	D0GD470JA052	M 47 OHM, J, 1/8W	1	PAVCCZ
	R16786	D1BD5902A044	M 59KOHM, F.1/8W	1	PAVCCZ
	R16791	D0GB102JA065	M 1KOHM, J, 1/10W	1	
	R16798	D0GB222JA065	M 2.2KOHM, J, 1/10W	1	
	R16799	D0GB102JA065	M 1KOHM, J, 1/10W	1	
	R16815	D0GB103JA065	M 10K OHM J 1/10W	1	
	R16818	D1BB3302A055	M 33KOHM, J.1/10W	1	
	R16819	D1BD1693A044	M 169KOHM, F.1/8W	1	PAVCCZ
	R16820	D1BD1693A044	M 169KOHM, F.1/8W	1	PAVCCZ
	R16822	D1BD8202A044	M 82KOHM, J.1/8 W	1	
	R16823	D1BD6192A044	M61.9KOHM, J.1/8 W	1	
	R16824	D1BD3742A044	M37.4KOHM, F.1/8W	1	
	R16825	D0GD154JA059	M 150KOHM, J, 1/4W	1	
	R16826	D0GB103JA065	M 10K OHM J 1/10W	1	
	R16829	D0GB102JA065	M 1KOHM, J, 1/10W	1	
	R16831	D1BD6812A077	M68.1KOHM, D.1/10W	1	PAVCCZ
	R16832	D1BD7152A077	M71.5K0OHM, D.1/10W	1	PAVCCZ
	R16833	ERG1SJ683	M 68KOHM, J, 1W	1	
	R16834	ERG1SJ683	M 68KOHM, J, 1W	1	
	R16838	ERG2FJS104D	M 100KOHM, J, 2W	1	
	R16841	D0GB472JA065	M 4.7KOHM, J, 1/10W	1	
	R16842	D0GD102JA052	M 1.0KOHM, J, 1/8W	1	PAVCCZ
	R16844	ERA6YEB242	M 2.4KOHM, B 1/10W	1	
	R16845	D1BD6982A077	M69.8KOHM, D.1/10W	1	PAVCCZ
	R16846	D1BD6042A077	M60.4KOHM, D.1/10W	1	PAVCCZ
	R16847	D1BD6492A077	M64.9KOHM, D.1/10W	1	PAVCCZ
	R16851	D0GB474JA065	M 470KOHM, J, 1/10W	1	
	R16852	D0GB474JA065	M 470KOHM, J, 1/10W	1	
	R16856	D0GB102JA065	M 1KOHM, J, 1/10W	1	
	R16873	ERA6YEB242	M 2.4KOHM, B 1/10W	1	
	R16891	D1BF6982A058	M 69.8KOHM, 1/4W	1	
	R16892	D1BF8252A058	M82.50KOHM, 1/4W	1	
	R16893	D1BF8252A058	M82.50KOHM, 1/4W	1	
	R16894	D1BB3091A087	M3.09KOHM, D 1/16W	1	PAVCCZ
	R16895	D1BB9091A087	M9.09 KOHM, J.1/10W	1	PAVCCZ
	R16897	D1BB2262A055	M22.6KOHM F 1/10W	1	PAVCCZ
	R16898	D1BB1051A055	M1.05KOHM, J.1/10W	1	
	R16899	D1BB1372A055	M13.7KOHM, 1/10W	1	PAVCCZ
	R16900	D1BB3831A055	M3.83KOHM, D 1/16W	1	PAVCCZ
	R16902	D0GB6R2JA065	M 6.2 OHM J 1/10W	1	PAVCCZ
	R16919	D1BB1582A055	M15.8KOHM, 1/10W	1	PAVCCZ
	R16920	D0GB101JA065	M 100 OHM, J, 1/10W	1	
	R16921	D1BB2152A055	M 21.5KOHM, 1/10W	1	PAVCCZ
	R16922	D1BB9531A055	M9.53KOHM, J.1/10W	1	
	R16923	D1BB5111A055	M5.11KOHM, J.1/10W	1	
	R16924	D1BB1152A055	M 11.5KOHM 1/10W	1	PAVCCZ
	R16931	D1BF2R70A021	M 2.7 OHM, 1/4W	1	
	R16932	D0GD223JA052	M 22KOHM, J, 1/4W	1	PAVCCZ
	R16937	D0GB184JA065	M 180KOHM J 1/10W	1	PAVCCZ
	R16939	D0GD102JA052	M 1.0KOHM, J, 1/8W	1	PAVCCZ
	R16940	D0GB473JA065	M 47KOHM J. 1/10W	1	PAVCCZ
	R16941	D0GB472JA065	M 4.7KOHM, J, 1/10W	1	
	R16942	D0GB473JA065	M 47KOHM J. 1/10W	1	PAVCCZ
	R16945	D0GB471JA065	M 470 OHM, J, 1/10W	1	PAVCCZ
	R17101	D1BB49R90002	M 49 OHM, J.1/10W	1	
	R17102	D1BB49R90002	M 49 OHM, J.1/10W	1	
	R17103	D1BB49R90002	M 49 OHM, J.1/10W	1	
	R17104	D1BB49R90002	M 49 OHM, J.1/10W	1	
	R17105	D1BB49R90002	M 49 OHM, J.1/10W	1	
	R17106	D1BB49R90002	M 49 OHM, J.1/10W	1	

Model No. : TX-P42UT30B/Y Parts List



Safety	Ref. No.	Part No.	Part Name & Description	Q'ty	Remarks
	R17107	D1BB49R90002	M 49 OHM, J, 1/10W	1	
	R17108	D1BB49R90002	M 49 OHM, J, 1/10W	1	
	R17109	DOGZ1R0JA020	M 1 OHM, J, 1/2W	1	
	R17111	DOGZ1R0JA020	M 1 OHM, J, 1/2W	1	
	R17113	DOGZ1R0JA020	M 1 OHM, J, 1/2W	1	
	R17115	D0GBR00J0004	M 0 OHM J 1/10W	1	
	R17116	D0GBR00J0004	M 0 OHM J 1/10W	1	
	R17117	D0GF102JA047	M 1.0 KOHM, J, 1/3W	1	
	R17118	D0GB101JA065	M 100 OHM, J, 1/10W	1	
	R17119	D0GB101JA065	M 100 OHM, J, 1/10W	1	
	R17120	D0GB101JA065	M 100 OHM, J, 1/10W	1	
	R17121	D0GB101JA065	M 100 OHM, J, 1/10W	1	
	R17122	DOGZ1R0JA020	M 1 OHM, J, 1/2W	1	
	R17124	DOGZ1R0JA020	M 1 OHM, J, 1/2W	1	
	R17126	D0GB101JA065	M 100 OHM, J, 1/10W	1	
	R17127	D0GB101JA065	M 100 OHM, J, 1/10W	1	
	R17128	D0GB101JA065	M 100 OHM, J, 1/10W	1	
	R17129	D0GB101JA065	M 100 OHM, J, 1/10W	1	
	R17130	DOGZ1R0JA020	M 1 OHM, J, 1/2W	1	
	R17132	DOGZ1R0JA020	M 1 OHM, J, 1/2W	1	
	R17134	D0GD224JA052	M 220KOHM, J, 1/8W	1	PAVCCZ
	R17135	D0GB681JA065	M 680 OHM, J, 1/10W	1	PAVCCZ
	R17138	EXB38V470J	M 47 OHM 1/16 W	1	
	R17139	EXB38V470J	M 47 OHM 1/16 W	1	
	R17140	EXB38V681J	M 680 OHM 1/16 W	1	
	R17141	D0GB681JA065	M 680 OHM, J, 1/10W	1	PAVCCZ
	R17142	D0GF223JA047	M 22KOHM, J, 1/3W	1	PAVCCZ
	R17143	D0GB331JA065	M330 OHM J 1/10W	1	PAVCCZ
	R17144	D0GB102JA065	M 1KOHM, J, 1/10W	1	
	R17145	D0GBR00J0004	M 0 OHM J 1/10W	1	
	R17146	D0GBR00J0004	M 0 OHM J 1/10W	1	
	R17147	D1BB49R90002	M 49 OHM, J, 1/10W	1	
	R17148	D1BB49R90002	M 49 OHM, J, 1/10W	1	
	R17149	D1BB49R90002	M 49 OHM, J, 1/10W	1	
	R17150	D1BB49R90002	M 49 OHM, J, 1/10W	1	
	R17151	D1BB49R90002	M 49 OHM, J, 1/10W	1	
	R17152	D1BB49R90002	M 49 OHM, J, 1/10W	1	
	R17153	D1BB49R90002	M 49 OHM, J, 1/10W	1	
	R17154	D1BB49R90002	M 49 OHM, J, 1/10W	1	
	R17196	D0GB102JA065	M 1KOHM, J, 1/10W	1	
	R17201	D0GB101JA065	M 100 OHM, J, 1/10W	1	
	R17202	D0GB101JA065	M 100 OHM, J, 1/10W	1	
	R17203	D0GB101JA065	M 100 OHM, J, 1/10W	1	
	R17204	D0GB101JA065	M 100 OHM, J, 1/10W	1	
	R17205	DOGZ1R0JA020	M 1 OHM, J, 1/2W	1	
	R17207	DOGZ1R0JA020	M 1 OHM, J, 1/2W	1	
	R17209	D1BB49R90002	M 49 OHM, J, 1/10W	1	
	R17210	D1BB49R90002	M 49 OHM, J, 1/10W	1	
	R17211	D1BB49R90002	M 49 OHM, J, 1/10W	1	
	R17212	D1BB49R90002	M 49 OHM, J, 1/10W	1	
	R17213	D0GB101JA065	M 100 OHM, J, 1/10W	1	
	R17214	D0GB101JA065	M 100 OHM, J, 1/10W	1	
	R17215	D0GB101JA065	M 100 OHM, J, 1/10W	1	
	R17216	D1BB49R90002	M 49 OHM, J, 1/10W	1	
	R17217	D1BB49R90002	M 49 OHM, J, 1/10W	1	
	R17218	D0GB101JA065	M 100 OHM, J, 1/10W	1	
	R17219	D1BB49R90002	M 49 OHM, J, 1/10W	1	
	R17220	D1BB49R90002	M 49 OHM, J, 1/10W	1	
	R17221	DOGZ1R0JA020	M 1 OHM, J, 1/2W	1	
	R17223	DOGZ1R0JA020	M 1 OHM, J, 1/2W	1	
	R17225	DOGZ1R0JA020	M 1 OHM, J, 1/2W	1	
	R17227	DOGZ1R0JA020	M 1 OHM, J, 1/2W	1	

Model No. : TX-P42UT30B/Y Parts List

Safety	Ref. No.	Part No.	Part Name & Description	Q'ty	Remarks
	R17229	D0GZ1R0JA020	M 1 OHM, J,1/2W	1	
	R17231	D0GZ1R0JA020	M 1 OHM, J,1/2W	1	
	R17233	D0GB681JA065	M 680 OHM, J,1/10W	1	PAVCCZ
	R17236	EXB38V470J	M 47 OHM 1/16 W	1	
	R17237	EXB38V470J	M 47 OHM 1/16 W	1	
	R17238	EXB38V470J	M 47 OHM 1/16 W	1	
	R17239	EXB38V470J	M 47 OHM 1/16 W	1	
	R17240	EXB38V681J	M 680 OHM 1/16 W	1	
	R17241	EXB38V681J	M 680 OHM 1/16 W	1	
	R17242	EXB38V681J	M 680 OHM 1/16 W	1	
	R17243	D0GD224JA052	M 220KOHM, J,1/8W	1	PAVCCZ
	R17244	D0GF102JA047	M 1.0 KOHM, J,1/3W	1	
	R17245	D0GB681JA065	M 680 OHM, J,1/10W	1	PAVCCZ
	R17246	D0GF223JA047	M 22KOHM, J, 1/3W	1	PAVCCZ
	R17247	D0GB331JA065	M330 OHM J 1/10W	1	PAVCCZ
	R17248	D0GB102JA065	M 1KOHM, J,1/10W	1	
	R17249	D1BB49R90002	M 49 OHM, J,1/10W	1	
	R17250	D1BB49R90002	M 49 OHM, J,1/10W	1	
	R17251	D1BB49R90002	M 49 OHM, J,1/10W	1	
	R17252	D1BB49R90002	M 49 OHM, J,1/10W	1	
	R17253	D1BB49R90002	M 49 OHM, J,1/10W	1	
	R17254	D1BB49R90002	M 49 OHM, J,1/10W	1	
	R17255	D1BB49R90002	M 49 OHM, J,1/10W	1	
	R17256	D1BB49R90002	M 49 OHM, J,1/10W	1	
	SN2	K1KY02B00012	2P CONNECTOR	1	
	SN20	K1MY35BA0345	35P CONNECTOR	1	
	SN21	K1MND6BA0264	6P CONNECTOR	1	
	SN22	K1MND6BA0264	6P CONNECTOR	1	
	SN23	K1MND6BA0264	6P CONNECTOR	1	
	SN24	K1MND6BA0264	6P CONNECTOR	1	
	SN25	K1MND6BA0264	6P CONNECTOR	1	
	SN26	K1MND6BA0264	6P CONNECTOR	1	
	SN27	K1MND6BA0264	6P CONNECTOR	1	
	SN28	K1MND6BA0264	6P CONNECTOR	1	
	SS11	K1KY03B00006	3P CONNECTOR	1	
	SS33	K1MY20BA0345	20P CONNECTOR	1	
	SS61	K1MN13B00091	13P CONNECTOR	1	
	SS66	K1MN13B00091	13P CONNECTOR	1	
	T16471	G4DYA0000253	SWITCHING TRANS	1	PAVCCZ
	T16472	G4DYA0000252	SWITCHING TRANS	1	PAVCCZ
	ZA16001	K4AZ01D00004	TERMINAL	1	
	ZA16002	K4AZ01D00004	TERMINAL	1	
	ZA16401	K4AZ01D00004	TERMINAL	1	
	ZA16402	K4AZ01D00004	TERMINAL	1	
	ZA17101	K4CD01000013	AV TERMINAL	1	
	ZA17102	K4CD01000013	AV TERMINAL	1	
	ZA17103	K4CD01000013	AV TERMINAL	1	
	ZA17104	K4CD01000013	AV TERMINAL	1	
	ZA17201	K4CD01000013	AV TERMINAL	1	
	ZA17202	K4CD01000013	AV TERMINAL	1	
	ZA17203	K4CD01000013	AV TERMINAL	1	
	ZA17204	K4CD01000013	AV TERMINAL	1	

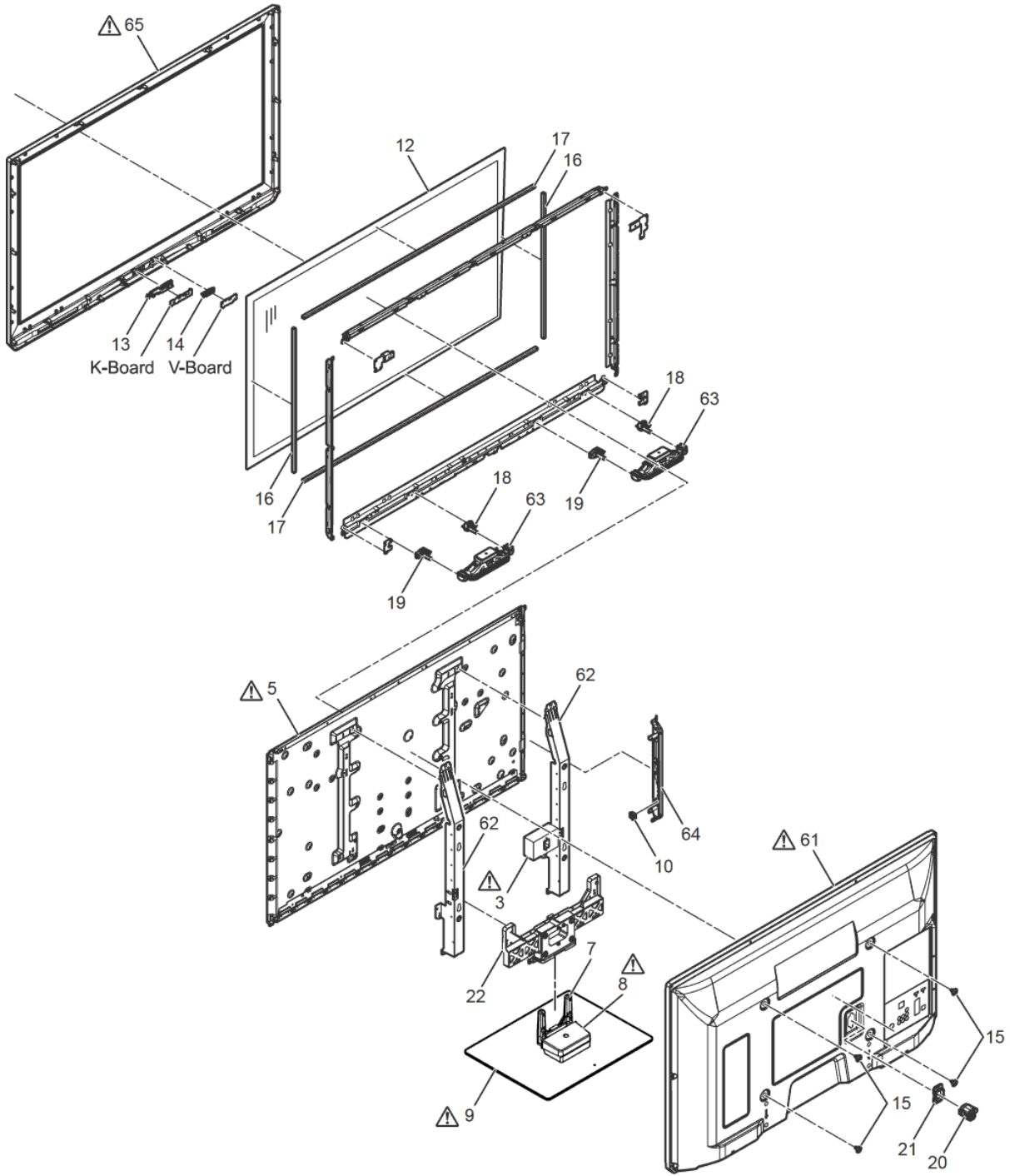
Model No. : TX-P42UT30B/Y Exploded View 1

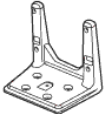
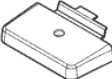
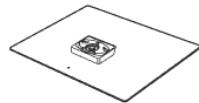

Assembly screws 72  M5 × 20 (silver) (4) 71  M4 × 8 (black)		11  M5 × 25 (black) (4)	7 Stand pole (1) 	⚠ 8 Pole cover (1) 	⚠ 9 Base (1) 
--	--	--	--	---	--

Model No. : TX-P42UT30B/Y Exploded View 2

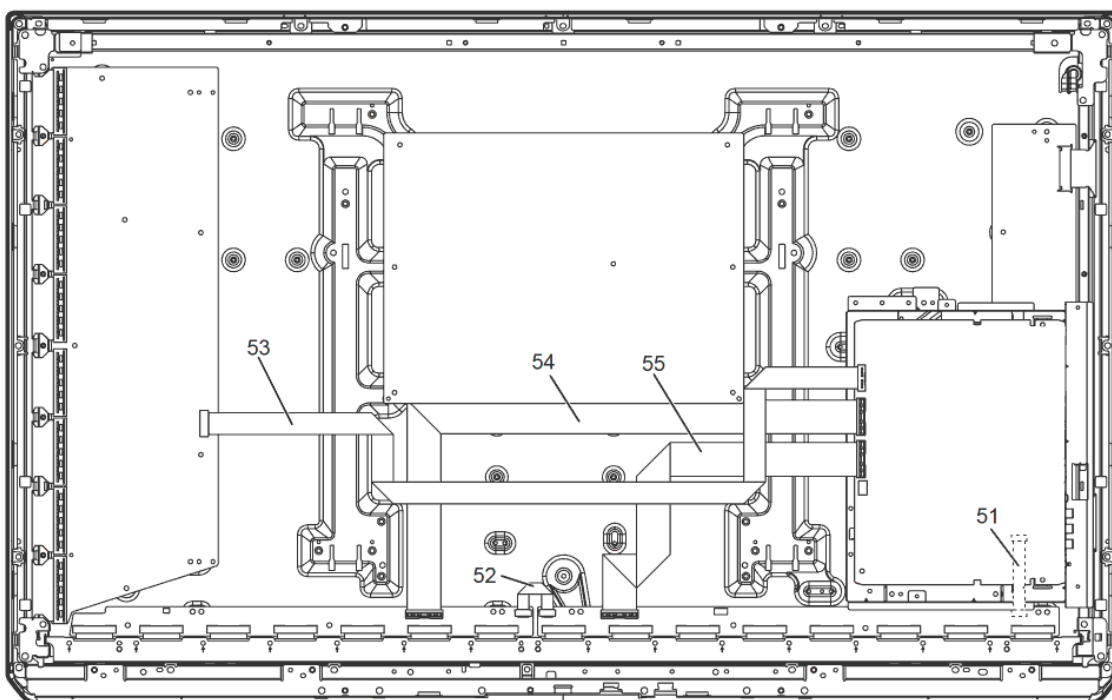

Model No. : TX-P42UT30B/Y Packing 1

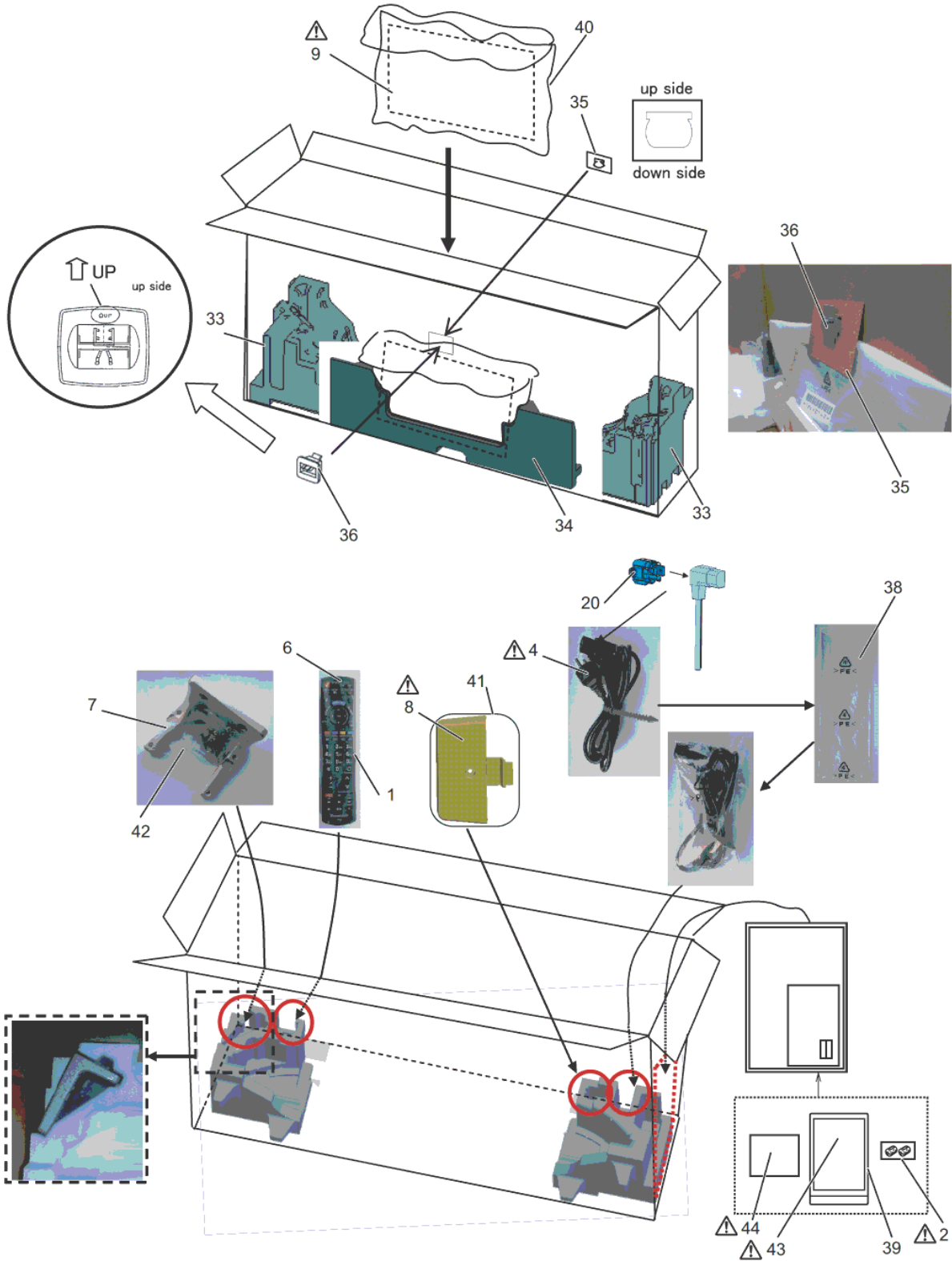

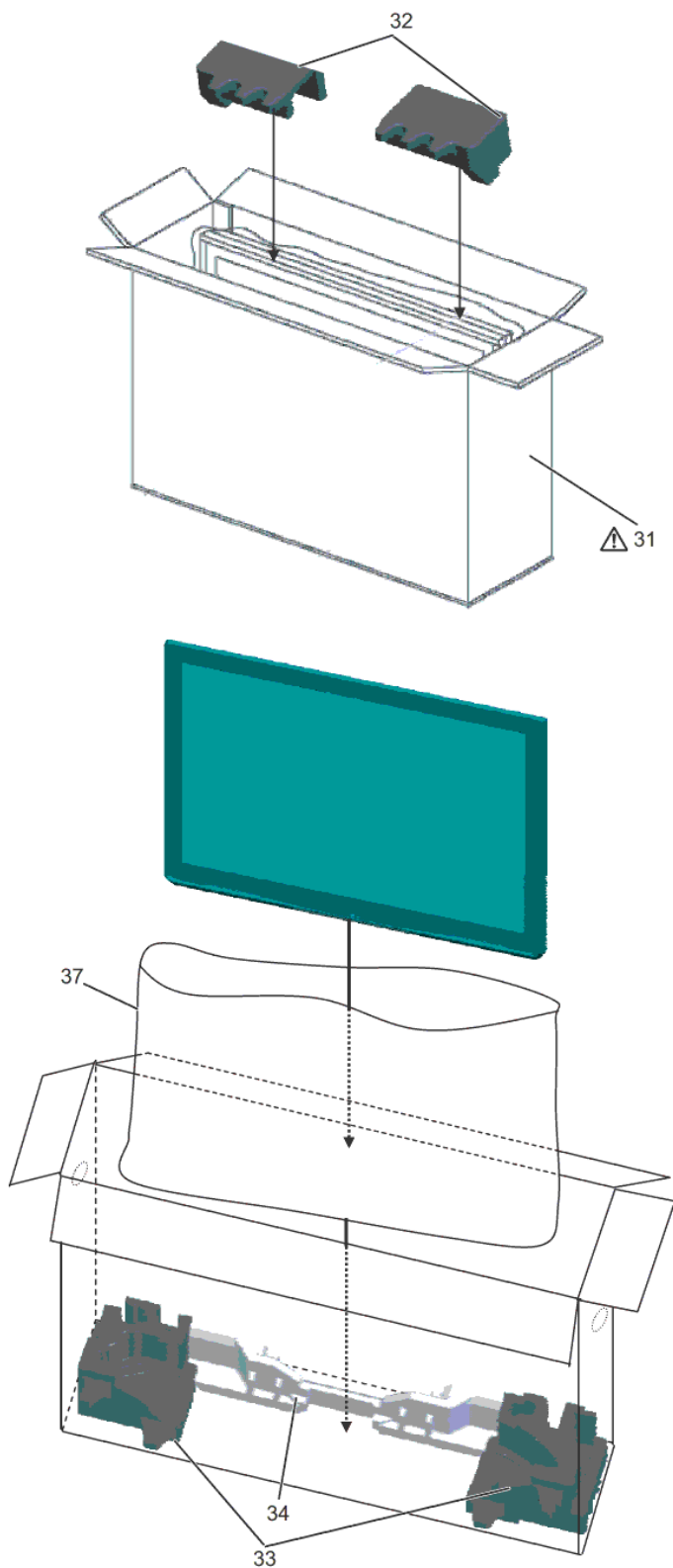













Model No. : TX-P42UT30B/Y Parts List

Safety	Ref. No.	Part No.	Part Name & Description	Q'ty	Remarks
	1	BAT-C-0572	Battery Cover of RC	1	PAVCCZ
	2	J0KG0000146	FERRITE CORE PACK	1	
	3	K2AHYH000041	AC-INLET WITH CABLE	1	PAVCCZ
	4	K2CN3YY00006	AC CORD	1	(Y)
	4	K2CT3YY00021	AC CORD	1	(B)
	5	MD42F14C1Z	PLASMA DISPLAY PANEL	1	PAVCCZ
	6	N2QAYB000572	REMOTE CONTROL	1	PAVCCZ
	7	TBL5ZA3055	STAND POLE	1	PAVCCZ
	8	TBL5ZB3094-1	POLE COVER	1	PAVCCZ
	9	TBL5ZX0203	PEDESTAL STAND	1	PAVCCZ
	10	TBX3EA00401	POWER BUTTON	1	
		THEJ036J	SCREW(P:7 TU_SHEILD:3 ATTACH_METAL:6)	16	
		THEJ036J	SCREW(SS:5 SN:8 K-P:2)	15	
		THEJ036J	SCREW(C:8)	8	
		THEJ0409	SCREW	8	chap.3.1. (3)
		THEL0239	SCREW(DD:15)	15	
		THEL052Z	SCREW	14	chap.3.1. (1)
	11	THEL087N	SCREW M5x25	4	
	12	TKGA5630	FRONT GLASS	1	PAVCCZ
	13	TKK2AC5008	LED PANEL	1	PAVCCZ
	14	TKKC5417	3D EMITTER PANEL	1	
	15	TKKL5493	M8 CAP	4	chap.3.1. (6)
	16	TMK0EG010	SPONGE(FRONT GLASS/LEFT/RIGHT)	2	PAVCCZ
	17	TMK0EG011	SPONGE(FRONT GLASS/UPPER/BOTTOM)	2	PAVCCZ
		TMME332	CLAMPER(HANGER:6 STAND BRACKET:2)	8	
		TMME380	CLAMPER	1	
		TMME381	EDGE SADDLE	1	PAVCCZ
		TMME397	SPACER	7	
	18	TMW3EX002	SP BRACKET L	2	
	19	TMW3EX003	SP BRACKET R	2	
	20	TMXX064	AC CORD CLAMPER A	1	
	21	TMXX065	AC CORD CLAMPER B	1	
	22	TMZ0E9925	STAND BRACKET	1	PAVCCZ
	31	TPC0EA09401	CARTON BOX	1	PAVCCZ
	32	TPD0E1151	TOP CUSHION	1	PAVCCZ
	33	TPD0E2194	BOTTOM CUSHION	1	PAVCCZ
	34	TPD0E9182	PEDESTAL CUSHION	1	PAVCCZ
	35	TPD0E9196	JOINT PAD	1	PAVCCZ
	36	TPDX0016-1	JOINT FOR PEDESTAL	1	
	37	TPE0E4047	SET BAG	1	PAVCCZ
	38	TPE0E9003	BAG FOR AC CORD	1	PAVCCZ
	39	TPE0E9008	BAG (INSTRUCTION BOOK)	1	PAVCCZ
	40	TPEB493	BAG (PEDESTAL STAND)	1	PAVCCZ
	41	TPEB496	BAG (POLE COVER)	1	PAVCCZ
	42	TPEB514	BAG (STAND POLE)	1	PAVCCZ
		TPG0E4050	PAPER CAP	0.25	PAVCCZ
	43	TQB0E2163	INSTRUCTION BOOK(ENGLISH)	1	(B) PAVCCZ
	43	TQB0E2165A	INSTRUCTION BOOK(GERMAN)	1	(Y) PAVCCZ
	43	TQB0E2165B	INSTRUCTION BOOK(DUTCH)	1	(Y) PAVCCZ
	43	TQB0E2165C	INSTRUCTION BOOK(ITALIAN)	1	(Y) PAVCCZ
	43	TQB0E2165D	INSTRUCTION BOOK(FRENCH)	1	(Y) PAVCCZ
	43	TQB0E2165E	INSTRUCTION BOOK(SPANISH)	1	(Y) PAVCCZ
	43	TQB0E2165F	INSTRUCTION BOOK(SWEDISH)	1	(Y) PAVCCZ
	43	TQB0E2165G	INSTRUCTION BOOK(NORWEGIAN)	1	(Y) PAVCCZ
	43	TQB0E2165H	INSTRUCTION BOOK(FINNISH)	1	(Y) PAVCCZ
	43	TQB0E2165I	INSTRUCTION BOOK(LITHUANIAN)	1	(Y) PAVCCZ
	43	TQB0E2165J	INSTRUCTION BOOK(PORTUGUESE)	1	(Y) PAVCCZ
	43	TQB0E2165K	INSTRUCTION BOOK(DANISH)	1	(Y) PAVCCZ
	43	TQB0E2165M	INSTRUCTION BOOK(BULGARIAN)	1	(Y) PAVCCZ
	43	TQB0E2165N	INSTRUCTION BOOK(ROMANIAN)	1	(Y) PAVCCZ
	43	TQB0E2165O	INSTRUCTION BOOK(LATVIAN)	1	(Y) PAVCCZ
	43	TQB0E2165P	INSTRUCTION BOOK(POLISH)	1	(Y) PAVCCZ

Model No. : TX-P42UT30B/Y Parts List

Safety	Ref. No.	Part No.	Part Name & Description	Q'ty	Remarks
	43	TQB0E2165Q	INSTRUCTION BOOK(HUNGARIAN)	1	(Y) PAVCCZ
	43	TQB0E2165R	INSTRUCTION BOOK(CZECH)	1	(Y) PAVCCZ
	43	TQB0E2165S	INSTRUCTION BOOK(GREEK)	1	(Y) PAVCCZ
	43	TQB0E2165T	INSTRUCTION BOOK(TURKISH)	1	(Y) PAVCCZ
	43	TQB0E2165U	INSTRUCTION BOOK(ENGLISH)	1	(Y) PAVCCZ
	43	TQB0E2165V	INSTRUCTION BOOK(CROATIAN)	1	(Y) PAVCCZ
	43	TQB0E2165W	INSTRUCTION BOOK(SLOVAKIAN)	1	(Y) PAVCCZ
	43	TQB0E2165Z	INSTRUCTION BOOK(ESTONIAN)	1	(Y) PAVCCZ
	44	TQB0E2165X	INSTRUCTION BOOK(CD-ROM)	1	(Y) PAVCCZ
		TQZJ349	SCREW USE HANDBILE	1	PAVCCZ
	51	TSXM231	CABLE(C23-SS33)	1	PAVCCZ
	52	TSXM237-1	CABLE(C10-C20)	1	PAVCCZ
	53	TSXM445	CABLE(A20-SN20)	1	PAVCCZ
	54	TSXM446	CABLE(A31-C11)	1	PAVCCZ
	55	TSXM447	CABLE(A32-C21)	1	PAVCCZ
	61	TTU0E1013	REAR COVER	1	(B) PAVCCZ
	61	TTU0E1014	REAR COVER	1	(Y) PAVCCZ
	62	TUX0EA023	42 HANGER METAL	2	PAVCCZ
	63	TXFEA01RLUE	SPEAKER L/R ASSY	2	PAVCCZ
	64	TXFKP01REUE	SIDE TERMINAL COVER ASSY	1	PAVCCZ
	65	TXFKY5Z0172	CABINET ASSY	1	PAVCCZ
		TXJA11RRUE	SPEAKER LEAD(A11-SPL/SPR)	1	PAVCCZ
		XSB3+6FJ	SCREW(HDMI-SIDE:1)	1	
	71	XSB4+8FNK	SCREW M4x8	1	
		XTB4+12GFJ	SCREW(GH:14 3D_LED:1)	15	
		XTB4+12GFJK	SCREW(BC:8)	8	chap.3.1. (2)
		XTV3+10JFJK	SCREW(REAR AV:2)	2	chap.3.1. (4)
		XYN3+F10FJK	SCREW(BC-AC_INLET:2)	2	chap.3.1. (5)
		XYN3+F8FJ	SCREW(A-PRINT:4)	4	
		XYN4+E8FJ	SCREW	1	
		XYN4+F10FJ	SCREW(KARI-HANGER METAL:4)	4	
	72	XYN5+F20FN	SCREW M5x20 SILVER	4	
		XZB6X12B03	POLY BAG(SCREW)	1	