

CMO Confidential for Hisense Only

CMO Confidential for Hisense Only

CMO Confidential for Hisense Only

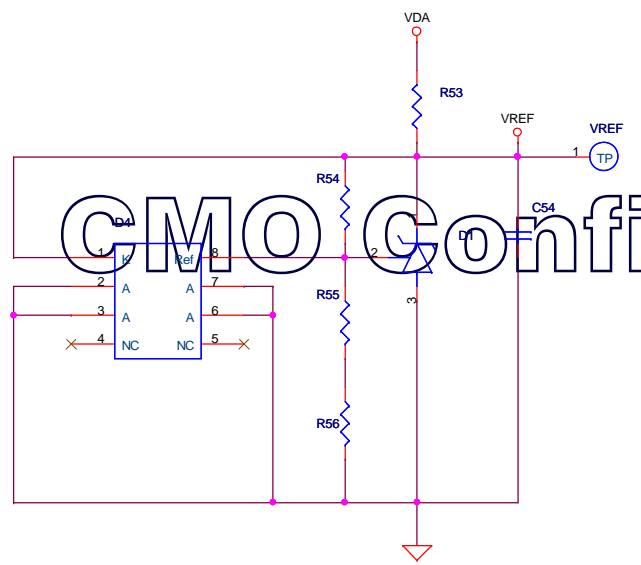
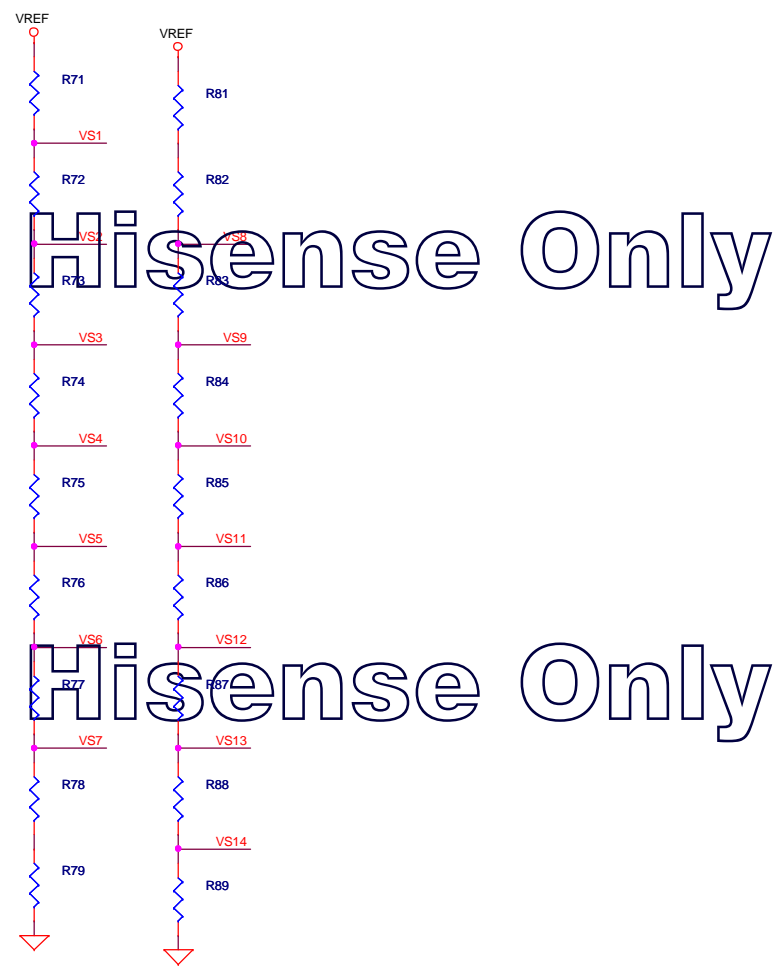
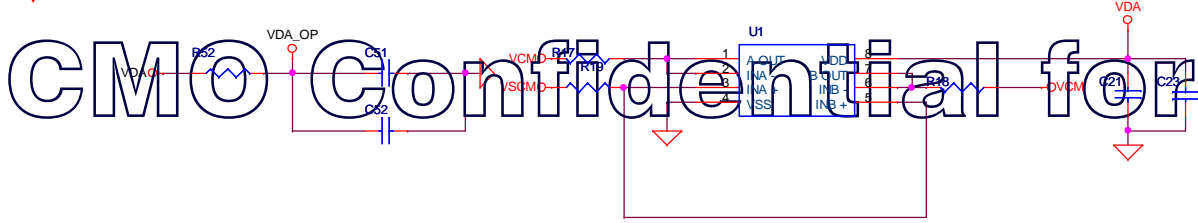
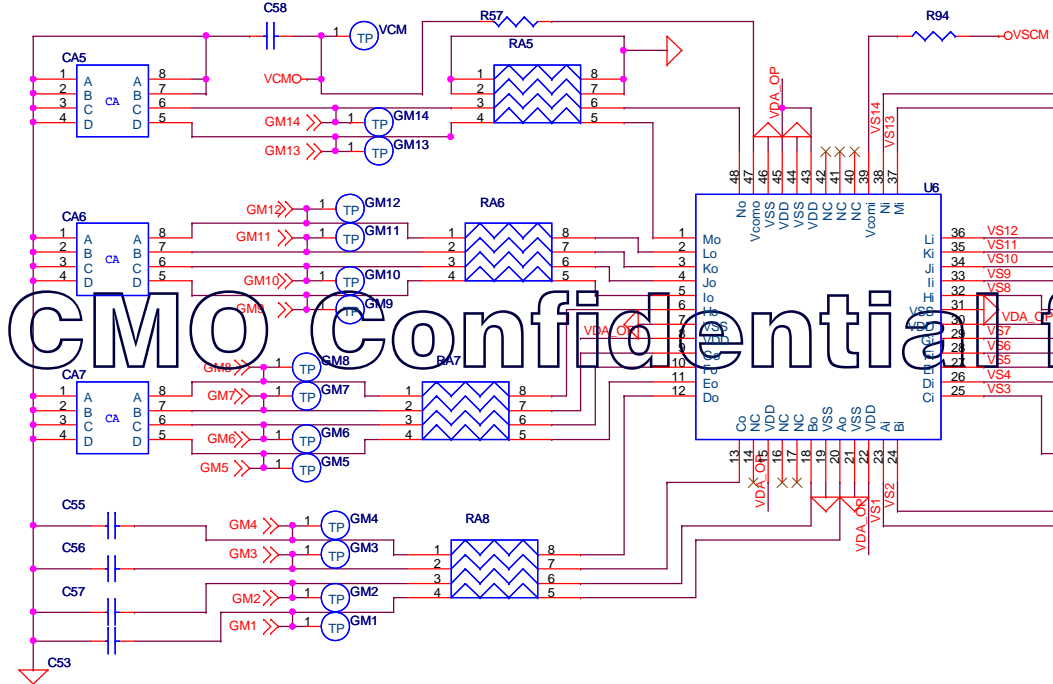

CHI MEI 奇美電子股份有限公司
OPTOELECTRONICS

Title V315B3-L01-C

DWG NO. T315C200401 VER. 04

DATE 2008/01/08 SHEET < 4 / 4 >

Remark

APPROVED	CHECKED	DESIGNER

CHI MEI COPYRIGHT 2002. ALL RIGHTS RESERVED,COPYING FORBIDDEN

CMO Confidential for Hisense Only

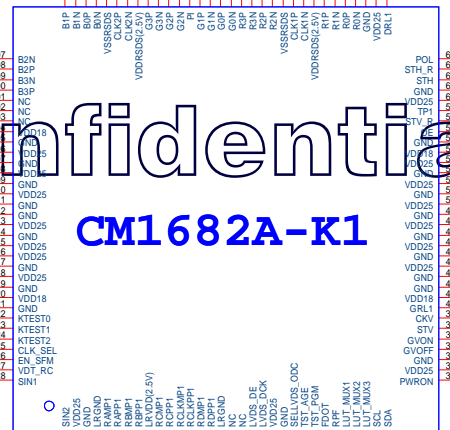

CM1682A-K1

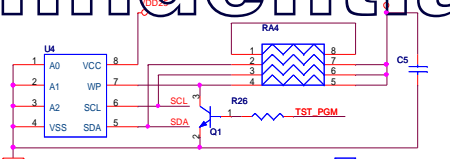
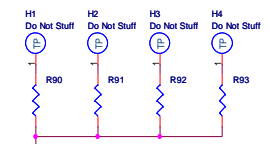
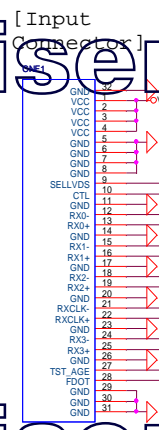
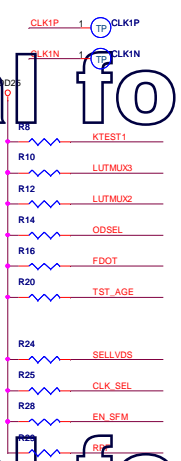
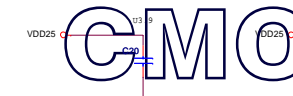
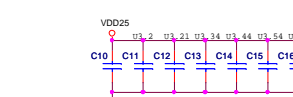
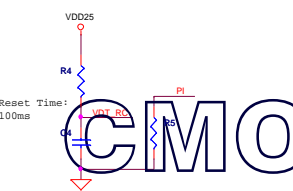
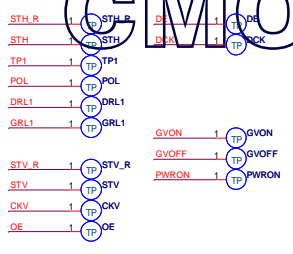
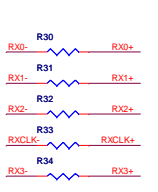

- TST_PGM 1 Do Not Stuff
- SCL 1 Do Not Stuff
- V12VI 1 Do Not Stuff
- SDA 1 Do Not Stuff
- GND Do Not Stuff

APPROVED	CHECKED	DESIGNER
Anderson	Kevin	JCWu

CHI MEI OPTOELECTRONICS 奇美電子股份有限公司

Title V315B3-L01-C (TCON)	
DWG NO. T315C200401	VER. 04
DATE 2008/01/08	SHEET < 1 / 3 >
Remark	
CHI MEI COPYRIGHT 2002. ALL RIGHTS RESERVED. COPYING FORBIDDEN	

CMO Confidential for Hisense Only

CMO Confidential for Hisense Only

CMO Confidential for Hisense Only

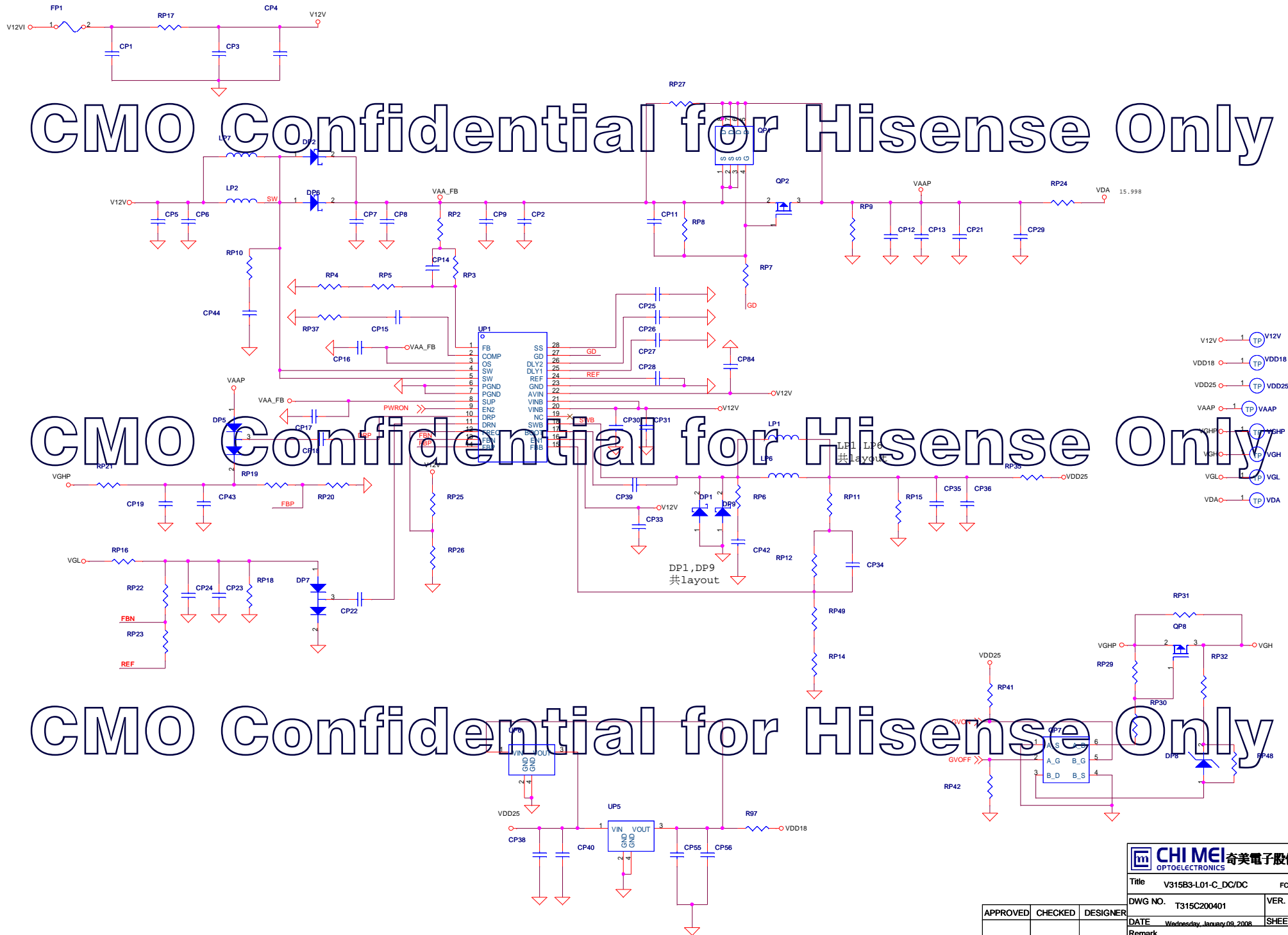

 CHI MEI 奇美電子股份有限公司 OPTOELECTRONICS		
Title	V315B3-L01-C_DC/DC	FC01.1
DWG NO.	T315C200401	VER. 04
DATE	Wednesday, January 08, 2008	SHEET 3/4
Remark		
CHI MEI COPYRIGHT 2002. ALL RIGHTS RESERVED. COPYING FORBIDDEN		

APPROVED	CHECKED	DESIGNER