



website:<http://biz.LGservice.com>
e-mail:<http://www.LGService.com/techsup.html>

COLOR TV

SERVICE MANUAL

CHASSIS : MC-049B

MODEL:RT-21FD35M/V/VX

CAUTION

BEFORE SERVICING THE CHASSIS,
READ THE SAFETY PRECAUTIONS IN THIS MANUAL.

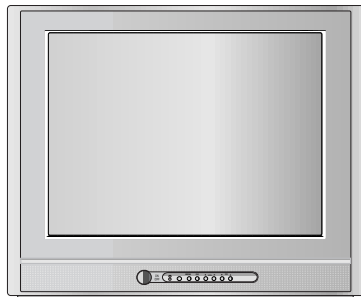

CONTENTS

Contents	2
Safety Precautions.....	3
Control Descriptions.....	4
Specifications	7
Adjustment Instructions	8
Trouble Shooting.....	12
Printed circuit board.....	16
Block Diagram	19
Exploded View	20
Exploded View Parts List	21
Replacement Parts List	22
SVC. Sheet.....	

SAFETY PRECAUTIONS

IMPORTANT SAFETY NOTICE

Many electrical and mechanical parts in this chassis have special safety-related characteristics. These parts are identified by Δ in the Schematic Diagram and Replacement Parts List.

It is essential that these special safety parts should be replaced with the same components as recommended in this manual to prevent X-RADIATION, Shock, Fire, or other Hazards.

Do not modify the original design without permission of manufacturer.

General Guidance

An **isolation Transformer should always be used** during the servicing of a receiver whose chassis is not isolated from the AC power line. Use a transformer of adequate power rating as this protects the technician from accidents resulting in personal injury from electrical shocks.

It will also protect the receiver and its components from being damaged by accidental shorts of the circuitry that may be inadvertently introduced during the service operation.

If any fuse (or Fusible Resistor) in this TV receiver is blown, replace it with the specified.

When replacing a high wattage resistor (Oxide Metal Film Resistor, over 1W), keep the resistor 10mm away from PCB.

Keep wires away from high voltage or high temperature parts.

Due to high vacuum and large surface area of picture tube, extreme care should be used in **handling the Picture Tube**. Do not lift the Picture tube by its Neck.

X-RAY Radiation

Warning:

The source of X-RAY RADIATION in this TV receiver is the High Voltage Section and the Picture Tube. For continued X-RAY RADIATION protection, the replacement tube must be the same type tube as specified in the Replacement Parts List.

To determine the presence of high voltage, use an accurate high impedance HV meter.

Adjust brightness, color, contrast controls to minimum. Measure the high voltage.

The meter reading should indicate
23.5 ; 15KV: 14-19 inch, 26 ; 15KV: 19-21 inch,
29.0 ; 15KV: 25-29 inch, 30.0 ; 15KV: 32 inch

If the meter indication is out of tolerance, immediate service and correction is required to prevent the possibility of premature component failure.

Before returning the receiver to the customer,

always perform an **AC leakage current check** on the exposed metallic parts of the cabinet, such as antennas, terminals, etc., to be sure the set is safe to operate without damage of electrical shock.

Leakage Current Cold Check(Antenna Cold Check)

With the instrument AC plug removed from AC source, connect an electrical jumper across the two AC plug prongs. Place the AC switch in the on position, connect one lead of ohm-meter to the AC plug prongs tied together and touch other ohm-meter lead in turn to each exposed metallic parts such as antenna terminals, phone jacks, etc.

If the exposed metallic part has a return path to the chassis, the measured resistance should be between $1M\Omega$ and $5.2M\Omega$.

When the exposed metal has no return path to the chassis the reading must be infinite.

An other abnormality exists that must be corrected before the receiver is returned to the customer.

Leakage Current Hot Check (See below Figure)

Plug the AC cord directly into the AC outlet.

Do not use a line Isolation Transformer during this check.

Connect 1.5K/10watt resistor in parallel with a 0.15uF capacitor between a known good earth ground (Water Pipe, Conduit, etc.) and the exposed metallic parts.

Measure the AC voltage across the resistor using AC voltmeter with 1000 ohms/volt or more sensitivity.

Reverse plug the AC cord into the AC outlet and repeat AC voltage measurements for each exposed metallic part. Any voltage measured must not exceed 0.75 volt RMS which is corresponds to 0.5mA.

In case any measurement is out of the limits specified, there is possibility of shock hazard and the set must be checked and repaired before it is returned to the customer.

Leakage Current Hot Check circuit

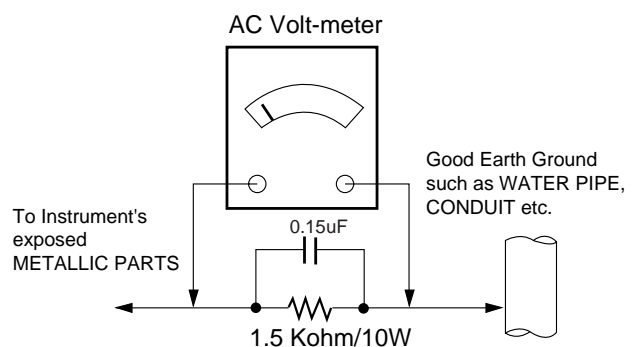

DESCRIPTION OF CONTROLS

All the functions can be controlled with the remote control handset. Some functions can also be adjusted with the buttons on the front panel of the set.

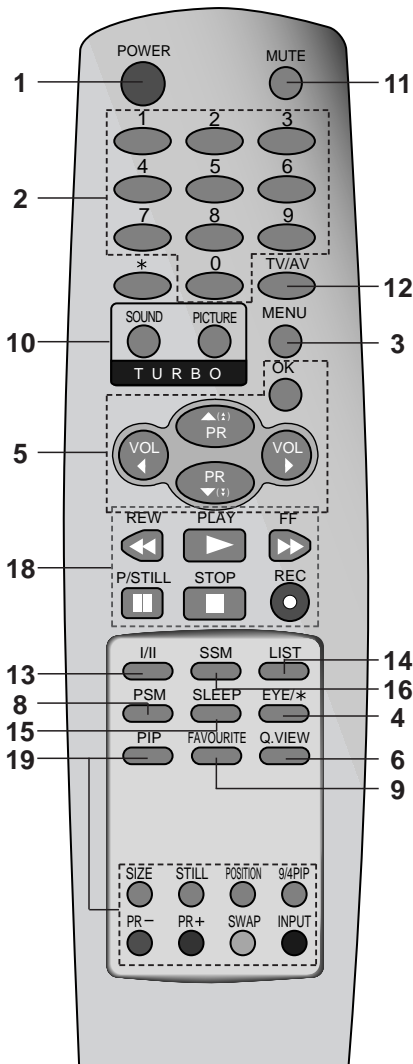

(Without TELETEXT / With PIP)

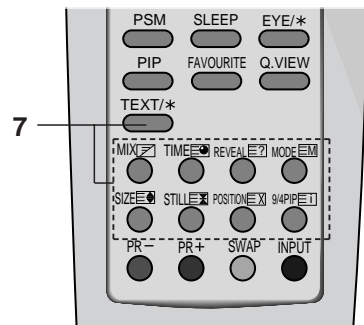

(With TELETEXT / PIP)

Remote control handset

Before you use the remote control handset, please install the batteries. See the next page.

1. **POWER**
switches the set on from standby or off to standby.
2. **NUMBER BUTTONS**
switches the set on from standby or directly select a number.
3. **MENU**
selects a menu.
4. **EYE/* (option)**
switches the eye function on or off.
5. **▲ / ▼ (Programme Up/Down)**
selects a programme or a menu item.
switches the set on from standby.
scans programmes automatically.
6. **◀ / ▶ (Volume Up/Down)**
adjusts the volume.
7. **OK**
accepts your selection or displays the current mode.
8. **Q.VIEW**
returns to the previously viewed programme.
9. **TELETEXT BUTTONS (option)**
These buttons are used for teletext.
For further details, see the 'Teletext' section.
10. **PSM (Picture Status Memory)**
recalls your preferred picture setting.
11. **FAVOURITE**
selects a favorite programme.
12. **TURBO PICTURE / SOUND BUTTON (option)**
selects Turbo picture and sound.
13. **MUTE**
switches the sound on or off.
14. **TV/AV**
selects TV or AV mode.
switches the set on from standby.

- 13. I/II/* (option)**
selects the language during dual language broadcast. (option)
selects the sound output.
- 14. LIST**
displays the programme table.
- 15. SLEEP**
sets the sleep timer.
- 16. SSM/* (option) (Sound Status Memory)**
recalls your preferred sound setting.
- 17. SURROUND (◀▶)/* (option)**
selects surround sound.
- 18. VCR BUTTONS**
control a LG video cassette recorder.
- 19. PIP BUTTONS (option)**
 - PIP**
switches the sub picture on or off.
 - PR +/-**
selects a programme for the sub picture.
 - SWAP**
alternates between main and sub picture.
 - INPUT**
selects the input mode for the sub picture.
 - SIZE**
adjusts the sub picture size.
 - STILL**
freezes motion of the sub picture.
 - POSITION**
relocates the sub picture in clockwise direction.
 - 9/4 PIP**
switches on or off the 9 or 4 sub pictures.

*** : No function**

COLOURED BUTTONS : These buttons are used for teletext (only TELETEXT models) or programme edit.

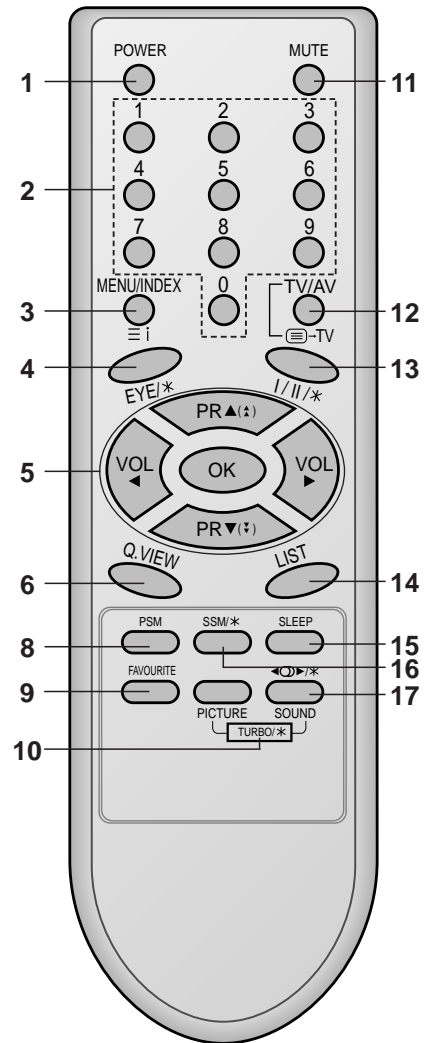

(Without TELETEXT / PIP)

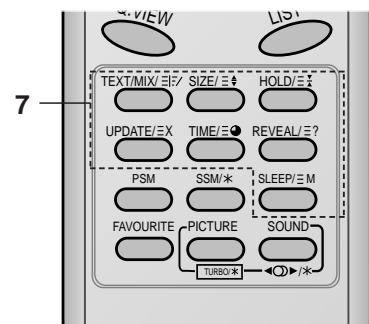

(With TELETEXT / Without PIP)

Front panel

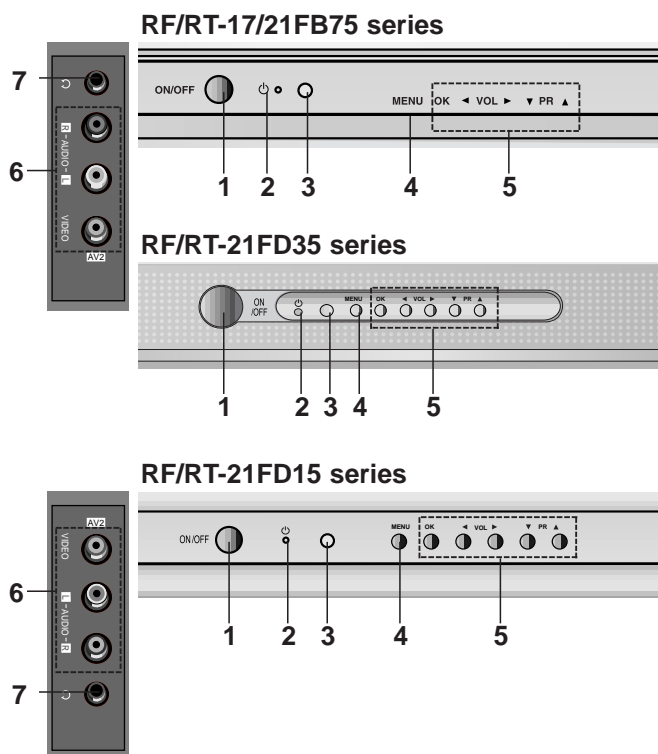

1. **MAIN POWER (ON/OFF)**
switches the set on or off.
2. **POWER/STANDBY INDICATOR**
illuminates brightly when the set is in standby mode.
dims when the set is switched on.
blinks when signal is input from the remote control.
3. **REMOTE CONTROL SENSOR**
4. **MENU**
selects a menu.
5. **OK**
accepts your selection or displays the current mode.
◀ / ▶ (Volume Up/Down)
adjusts the volume.
adjusts menu settings.
▲ / ▼ (Programme Up/Down)
selects a programme or a menu item.
switches the set on from standby.
6. **AUDIO/VIDEO IN SOCKETS (AV2) (option)**
Connect the audio/video out sockets of external equipment to these sockets.
7. **HEADPHONE SOCKET (option)**
Connect the headphone plug to this socket.
8. **EYE (option)**
adjusts picture according to the surrounding conditions.

Note :

- a. Do not place any heavy objects (over 4Kg) on the RF/RT-21FA35 series models.
- b. Shown is a simplified representation of front or side panel. Here shown may be somewhat different from your set.

SPECIFICATIONS

Note : Specification and others are subject to change without notice for improvement.

■ Scope

This specification can be applied to all the television related to MC-049B Chassis.

■ Test and Inspection Method

- 1) Capacity : Follow LG electronics TV testing Standard.
- 2) Another Required Standard
 - EMI : Following CE Standard (EN55020, EN55013)
 - Safety : Following CB Standard (EN55013)

■ Requirement for Test

Testing for standard of each par must be followed in below condition

- 1) Temperature : $20 \pm 5^{\circ}\text{C}$
(CST must be tested $40 \pm 5^{\circ}\text{C}$. Humidity : 50%)
- 2) Relative Humidity : $65 \pm 10\%$
- 3) Power : Standard input Voltage (110-240V~, 50/60Hz)
- 4) Measurement must be performed after heat-run more than 20min.
- 5) Adjusting Standard for this chassis is followed a special standard.

■ General Specification

No	Item	Specification	Remark
1	Receiving System	1) PAL/SECAM BG 2) PAL/SECAM DK 3) PAL I/I 4) NTSC M 5) SECAM-L/L' 6) NTSC 4.43(AV)	For EU/ For Non EU
2	Receiving Channel	1) VHF : E2 ~ E12 UHF : E21 ~ E69 CATV : S1 ~ S20 HYPER : S21 ~ S41 2) L/L' : B,C,D	For EU/ For Non EU
		3) VHF : 02 ~ 13 UHF : 14~ 69 CATV : 02 ~ 71	NTSC-M (Multi - model)
3	Input Voltage	110-240V~, 50/60Hz 240V~, 50Hz	Non EU EU
4	Market	EU,CIS, China, Asia, Africa	
5	Screen Size	14" ~ 21"	FLAT / CONVENTIONAL
6	Tuning System	FVS 100Program	
7	Operating Environment	1) Temp. : 0 ~ 45 deg 2) Humidity: 85% under	200 PR. (OPTION)
8	Storage Environment	1) Temp. : -20 ~ 60 deg 2) Humidity: 85% under	

ADJUSTMENT INSTRUCTIONS

1. Application Object

These instructions are applied to all of the color TV, MC-049B.

2. Notes

- (1) Because this is not a hot chassis, it is not necessary to use an isolation transformer. However, the use of isolation transformer will help protect test instrument.
- (2) Adjustment must be done in the correct order. But the adjustment can be changed by consideration of mass production.
- (3) The adjustment must be performed in the circumstance of $25 \pm 5^\circ\text{C}$ of temperature and $65 \pm 10\%$ of relative humidity if there is no specific designation.
- (4) The input AC voltage of the receiver must keep rating voltage in adjusting.
- (5) The receiver must be operated for about 15 minutes prior to the adjustment.

3. Focus adjustment

3.1. Preliminary steps

Tune the TV set to receive a digital pattern.
(SVC mode: Automatically mode change the STANDARD MODE)

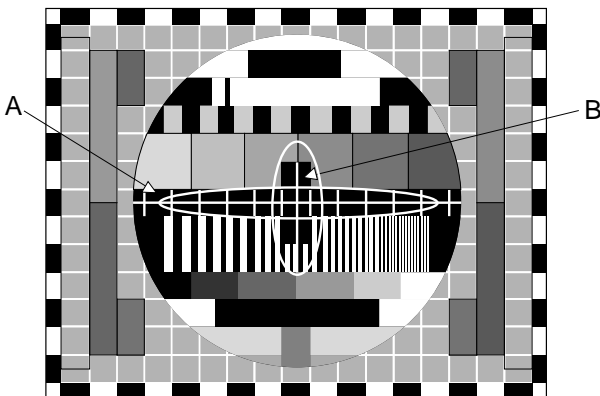

<Fig 1. PAL Digital Pattern(EU05CH)>

3.2. Adjustment Method

1) Single Focus CPT

Adjust the upper Focus volume of FBT for the best focus of horizontal line A, vertical line B.

4. Purity & Convergence adjustment

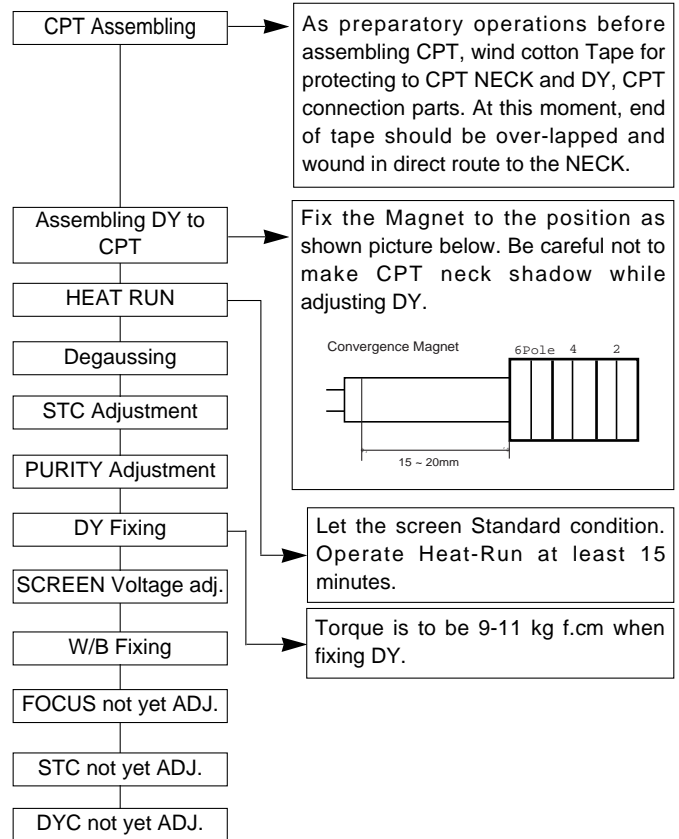

4.1. Color purity adjustment

- (1) It makes CPT enough to demagnetization.
- (2) Receive the signal of red raster.
- (3) Loosen fixed screw of DY and closely to CPT funnel part.
- (4) Check the center of screen that PURITY MAGNET of CPT by crossing adjustment. At this time, 4 & 6 pole magnet is located to magnet of nothing.
- (5) Move the DY to make equal red on whole screen and it does not to make the DY by fixed screw after check a simple color of Red/Green/Blue and white raster whether or not it is a pollution of color.
(At this time, take care raster of screen and DY must fixing in the condition which maintains a horizontality.)
- (6) Check the receiver by move direction. When adjustment is not working, adjust with the assisted MAGNET.

4.2. Convergence adjustment

These adjustments can the best condition of focus after finished purity adjustment.

- (1) Receive the signal of CROSS HATCH that BACK RASTER is black.
- (2) Adjust brightness and luminosity till dot appear 9 ~12.
- (3) Open angle of the two tab of 4 pole MAGNET by isogonic angle and accord with vertical line of red and blue color in the middle of screen.

- (4) Maintain as angle of (3) and rotate the tab to accord with vertical line of Red and Blue color in the middle of screen.
- (5) Open angle of the two tab of 6 pole magnet by isogonic angle and accord with vertical line of Red/Blue and Green.
- (6) Maintain as angle of (5) and rotate the tab to accord with horizontal line. In case of twisted horizontal line, repeat adjustment of (3) ~ (5) remembering the movement of Red/Green/Blue color.
- (7) Move the DY to best condition of convergence and attach the CPT to a rubber-chock for fixed DY.

5. Screen voltage adjustment

- (1) Receive the PAL or SECAM(NTSC) signal into RF mode regardless of channel.
- (2) If you press the "ADJ" button in LINE SVC mode(IN-START button), the LINE SVC mode changes to screen adjustment mode.
- (3) Adjust the screen volume of FBT jack, When width line is seen turn the FBT screen volume at the position of disappearance it.
- (4) Press the TV/AV button to exit SVC mode.

6. White balance adjustment

NOTE : When adjusting white balance automatically, connect the adjustment JIG in SVC mode. (When pressing ,MUTE button on remote control, it changes to CPU OFF MODE and screen displays "AUTO".)

- (1) Receive 100% white pattern.
- (2) Adjust LOW Light status(4.5FL) of CUT R, CUT B at CG:60.
- (3) Adjust HIGH Light status(35FL) of WDR R, WDR B at WDR G:450.
- (4) Repeat above step (2) and (3) for the best condition each status of High Light and Low Light.

<Table 1> White Balance Color analyzer

Menu	EU	N-EU
X	288	266
Y	295	273
Color Temperature	9000°K	13000°K

<Table 2> White Balance Initial Data

Menu	Menu	Range	DATA
LOW LIGHT	CUT R	0 ~ 511	60
	CUT G	0 ~ 511	60
	CUT B	0 ~ 511	60
HIGH LIGHT	WDR R	0 ~ 511	450
	WDR G	0 ~ 511	450
	WDR B	0 ~ 511	450

* Auto adjustment

<Table 3> White Balance Initial Data

1. IC

	Name	Maker	Algorithm		
VCD IC	VCT49xyi	Micronas	0	A	0
EP_ROM	24C16	ST, ATMEL			

2. White balance IIC Parameter

Program	TWBeng_v049	Program	TWBeng_v049	Speed	Delay
Vcd Slave	BCF0	Eprom_Slave	AE	1	30

	R_Amp	R_Cut	B_Amp	B_Cut
Program	TWBeng_v049	TWBeng_v049	TWBeng_v049	TWBeng_v049
Sub Add	1C8	1C3	1CA	1C5
Start Bit	12	12	12	12
Stop Bit	4	4	4	4
Offset	0	0	0	0
Polarity	1	1	1	1
EP_Rom_S	9091	8A8B	9495	8E8F

Speed/ Plus	1	1	1	1

<CAUTION> W/B Program "Twbeng_v049"

- W/B adjustment after Cutoff
 - : Instart -> adj. -> mute(cutoff)-> tv/av(wb)
 - Release key is EXIT key
- W/B adjustment
 - : Instart -> mute(cpuoff)
 - Release key is TV/AV key

7. Deflection setting Data Adjustment

7.1 Adjustment preparation

- (1) Tune the TV set to receive a Digital pattern(EU05CH).
- (2) Deflection setting data adjustment is operate by SVC communicator.
- (3) Enter the deflection adjustment mode by selection SERVICE1 on SERVICE MENU after pressing LINE SVC MODE(IN-START KEY).
- (4) Use the CH ▲, ▼ key to select adjustment item.
- (5) Use the VOL ◀, ▶ key to increase/decrease data.

<Note>

- (1) When adjusting a deflection, adjust N50Hz of PAL signal first and adjust a deflection at Normal 60Hz(NTSC).
- (2) Adjust a deflection as shown below.
PAL 4:3 -> NTSC 4:3
- (3) After finishing deflection adjustment, press the ENTER key to exit in adjustment mode.

* Before adjusting the PIP P(PIP Position), store the deflection data in the EEPROM by using the "ENTER" key.

7.2 Adjustment

- (1) VL(Vertical Linearity) adjustment:
Adjust the top & bottom size of inner circle to be equal.
- (2) VA (Vertical Amplitude) adjustment:
Adjust so that the circle of a digital circle pattern should be located interval of 6~7mm from the effective screen of the CPT.
- (3) SC (S correction) adjustment:
Adjust so that all distance between each lattice width of top/center/bottom are to be the same.

* Setting the CPT Default(Initial data) value like that, because it is decide by CPT DY value

(4) VS (Vertical Shift) adjustment:

Adjust so that the geometric vertical center line is in accord with vertical center line of CPT.

(5) HS(Horizontal Shift) adjustment:

Adjust so that the geometric horizontal center line is in accord with horizontal center line of CPT.

<Table 4> Initial deflection setting data

Menu	Variable range	N50Hz(PAL) FLAT 21"	N60Hz(NTSC) FLAT 21"
VS	-512~511	150	140
VA	-512~511	-12	-12
VL	-512~511	140	140
SC	-512~511	6	6
HS	32~2047	100	123

8.OPTION Adjustment

8-1. Preparation for Adjustment

- 1) This option adjustment decides function in accordance with model. Press IN-START button on SVC communicator, then adjust the option at OPTION1 mode.
- 2) Mark the option adjustment data like [111,111,111,111] in BOM.

8-2. Adjustment Method

OPTION data input

- 1) Function : YES, No function : NO
- 2) Select each OPTION function by the CH Up/Down button and then set up each OPTION(yes or no) by the VOL Up/Down button.

8-3. OPTION 1

Option	Code	Function
INCH	0	21A
	1	21B
	2	21C
	3	29F/25F
	4	28WF/32WF
	5	28N
	6	34F
	7	29N/25N
SYS	0	BG/I/DK
	1	BG/I/DK/L
	2	BG/I/DK/M
	3	BG/L
SOUND	0	RF STEREO
	1	AV STEREO
	2	MONO
	3	MONO DUAL
CH+AU	0	Using
	1	Not using

8-4. OPTION2 Function

Option	Code	Function
AV2	0	Without A/V2
	1	With AV2
DVD	0	Without DVD
	1	With DVD
SCART1	0	Without SCART1
	1	With SCART1
GAME	0	Without GAME function
	1	With GAME function
EYE	0	Without EYE
	1	With EYE
TX	0	LARGE
	1	SMALL
KEY	0	6,8 KEY
	1	4 KEY
DEGAU	0	Without DEGAU
	1	Whit DEGAU

8-5. OPTION3 Function

Option	Code	Function
TEXT	0	Without TEXT (200PR)
	1	With TEXT (100PR)
TOP	0	FLOP
	1	TOP
ACMS	0	Without ACMS
	1	With ACMS
I 2 SV	0	Without I 2 SV
	1	With I 2 SV
VOL	0	VOL 0
	1	VOL 1
TSEAR	0	Without TURBO SEARCH
	1	With TURBO SEARCH
T P-S	0	Without TURBO PICTURE/ SOUND
	1	With TURBO PICTURE/ SOUND
HDEV	0	Without HDEV
	1	With HDEV

8-6. OPTION4 Function

Option	Code	Function
OSD L	0	ENG ONLY
	1	EU-5EA
	2	EU ETC
	3	GREECE
	4	EU-ALL
	5	FARSI
	6	ARAB URDU
	7	E+HINDI
	8	E+I+M+V
	9	E+THAI
	10	E+CHINA
TXT L	0	WEST EU
	1	EAST EU1
	2	TURKEY EU
	3	EAST EU2
	4	CYRILLIC1
	5	CYRILLIC2
	6	CYRILLIC3
	7	TURK GRE1
	8	TURK GRE2
	9	TURK GRE3
	10	ARAB FRA
	11	ARAB ENG
	12	ARAB HEB1
	13	ARAB HEB2
	14	FARS ENG
	15	FARS FA
	16	FARS ALL
	17	AUTO
HOTEL	0	WITHOUT HDEV
	1	WITH HDEV
MAX V	0~	SETTING VOL MAX
	100	

TROUBLE SHOOTING

RF- STEREO MODEL

PICTURE O.K / NO SOUND

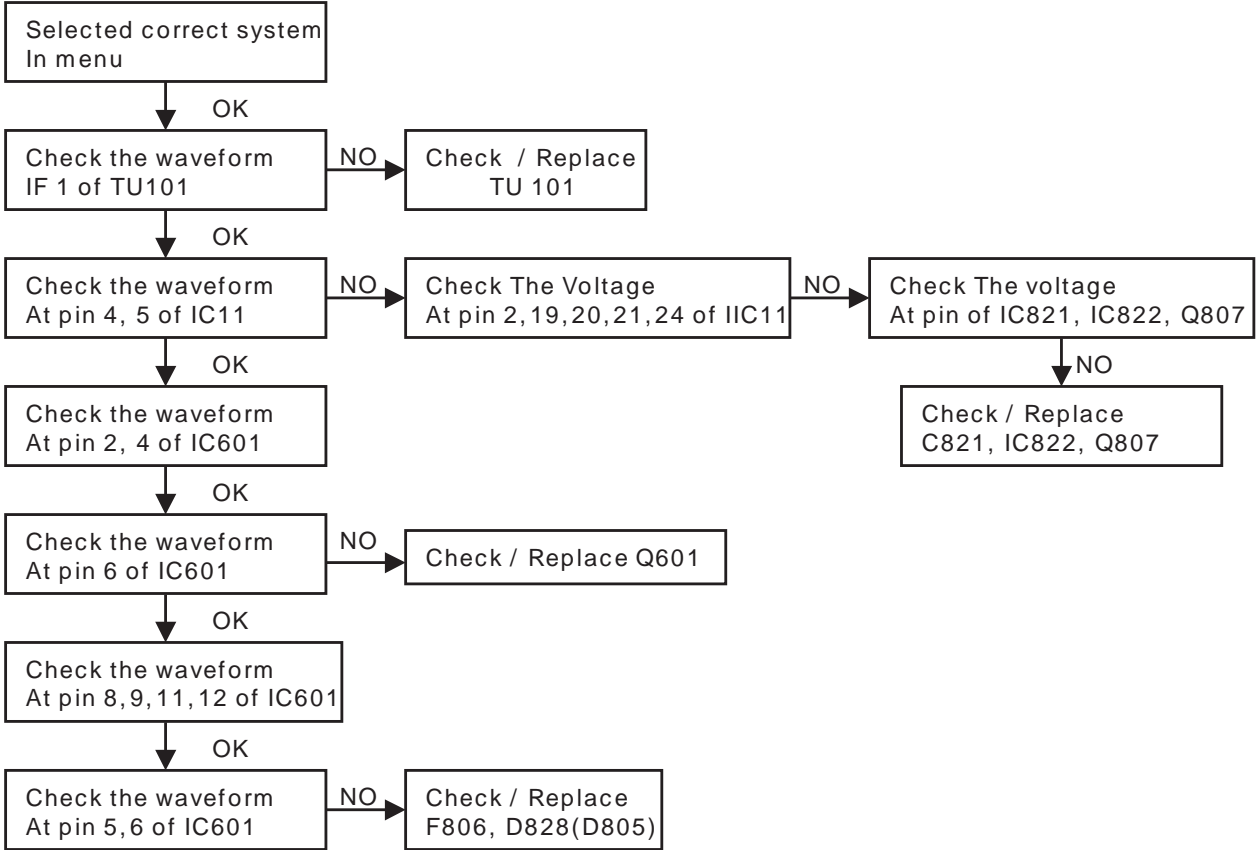

No Raster / Sound OK (1/2)

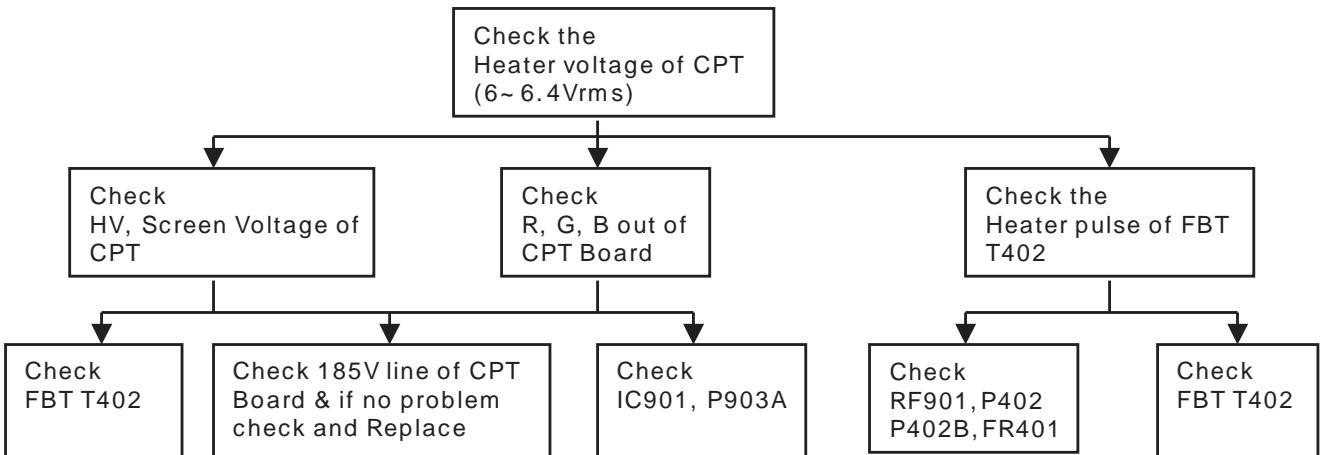

No Raster (2/2)

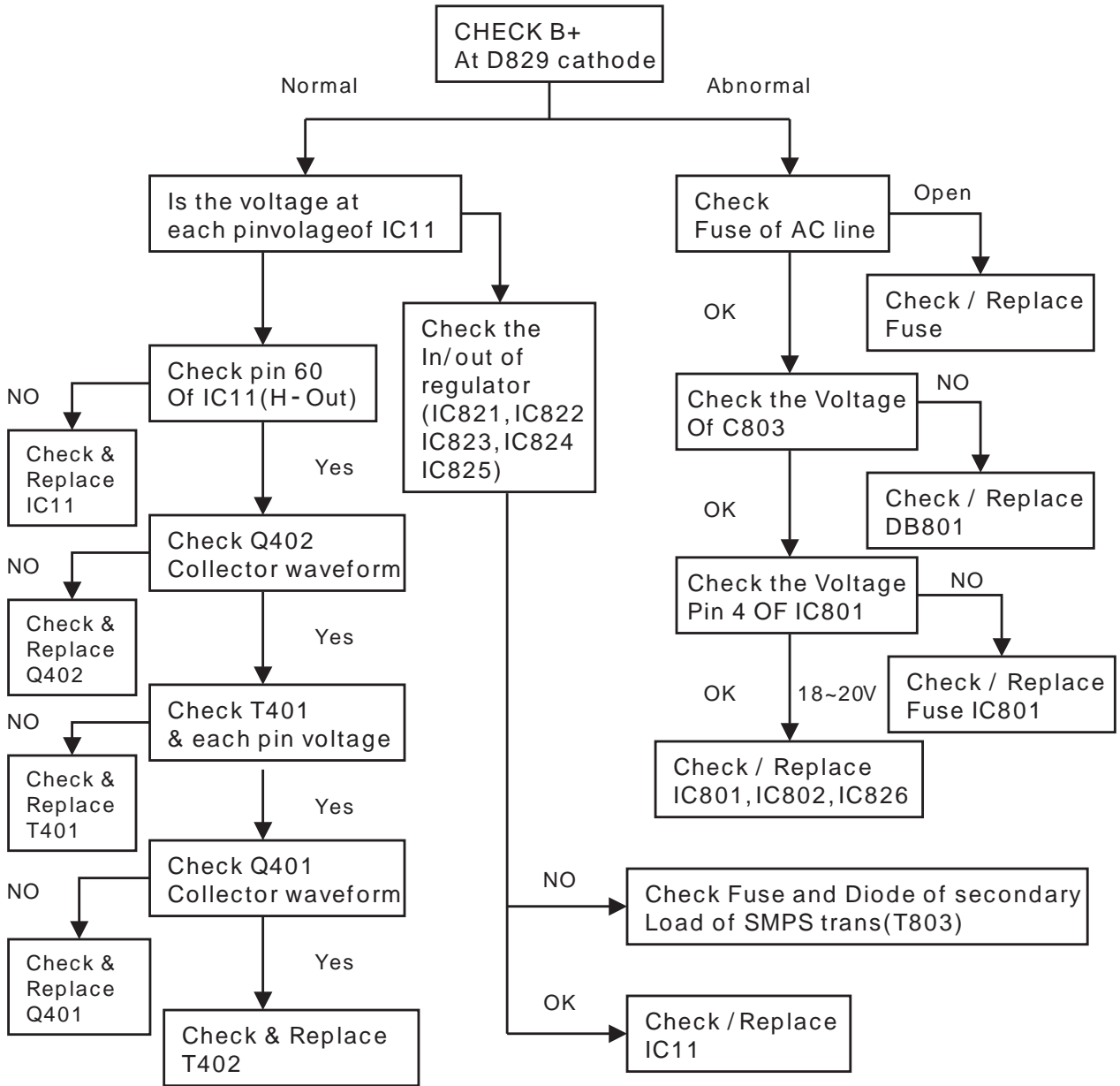

NO Picture / No Sound

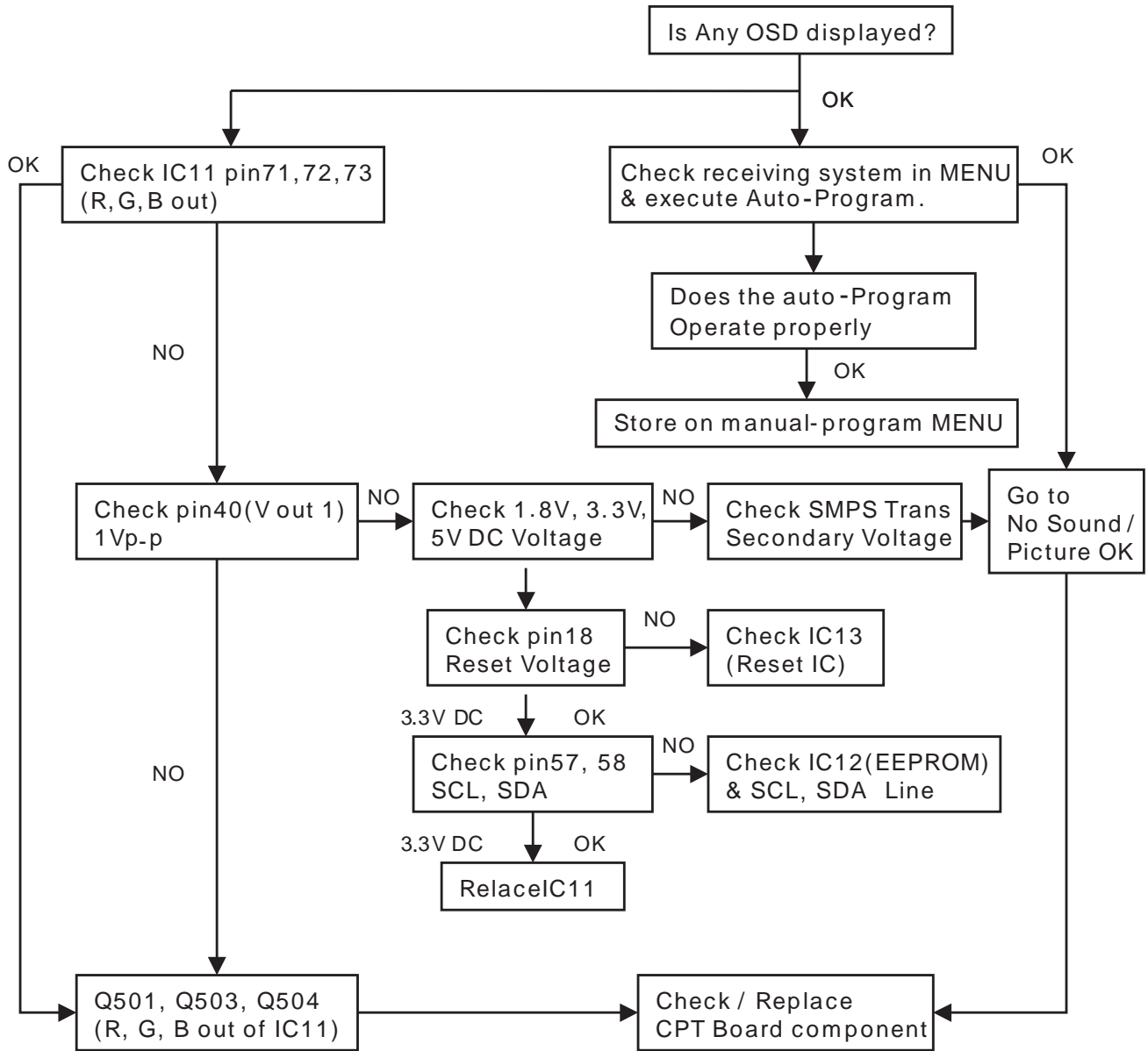

AV STERRO / MONO MODEL

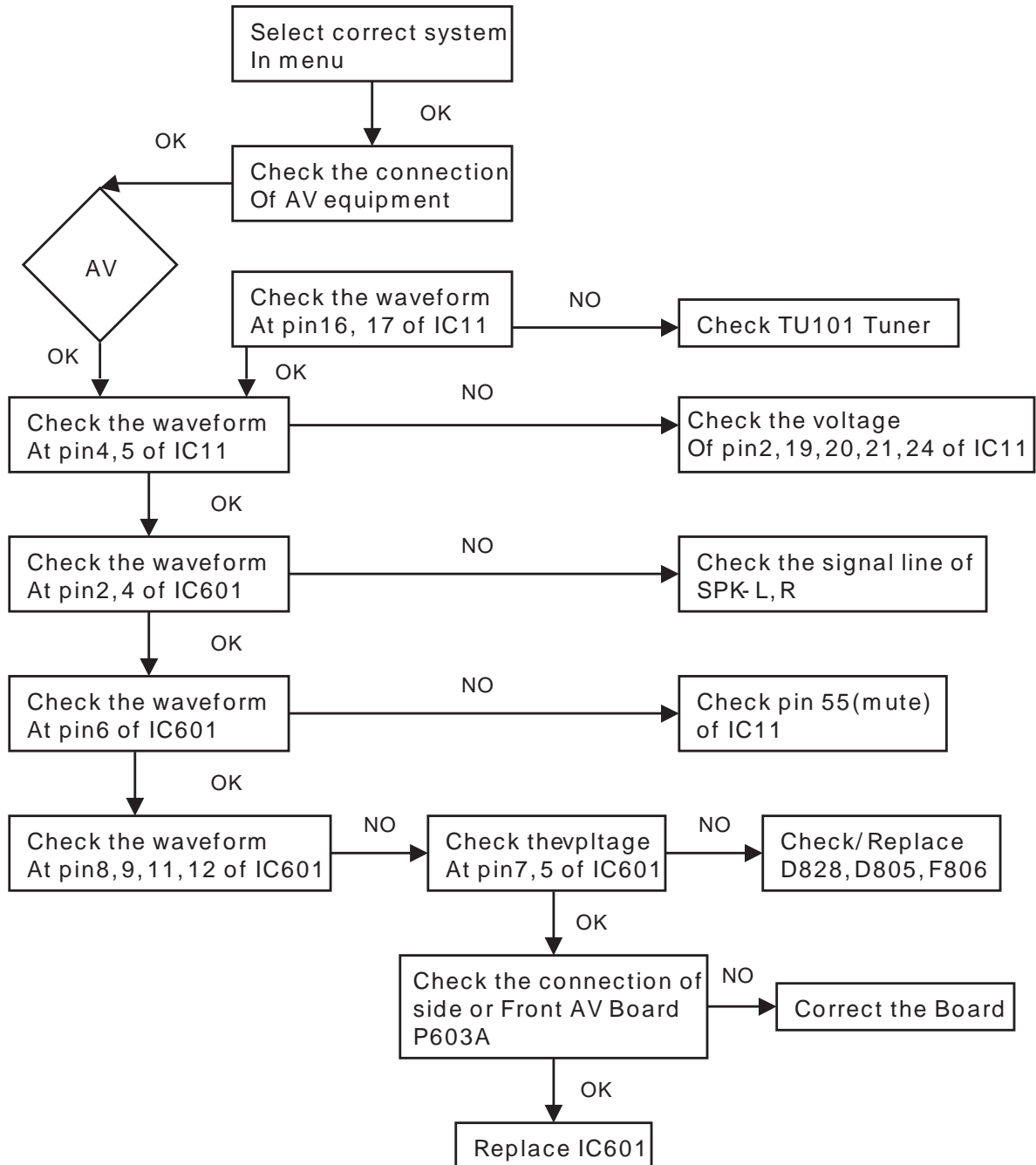

PRINTED CIRCUIT BOARD

MAIN

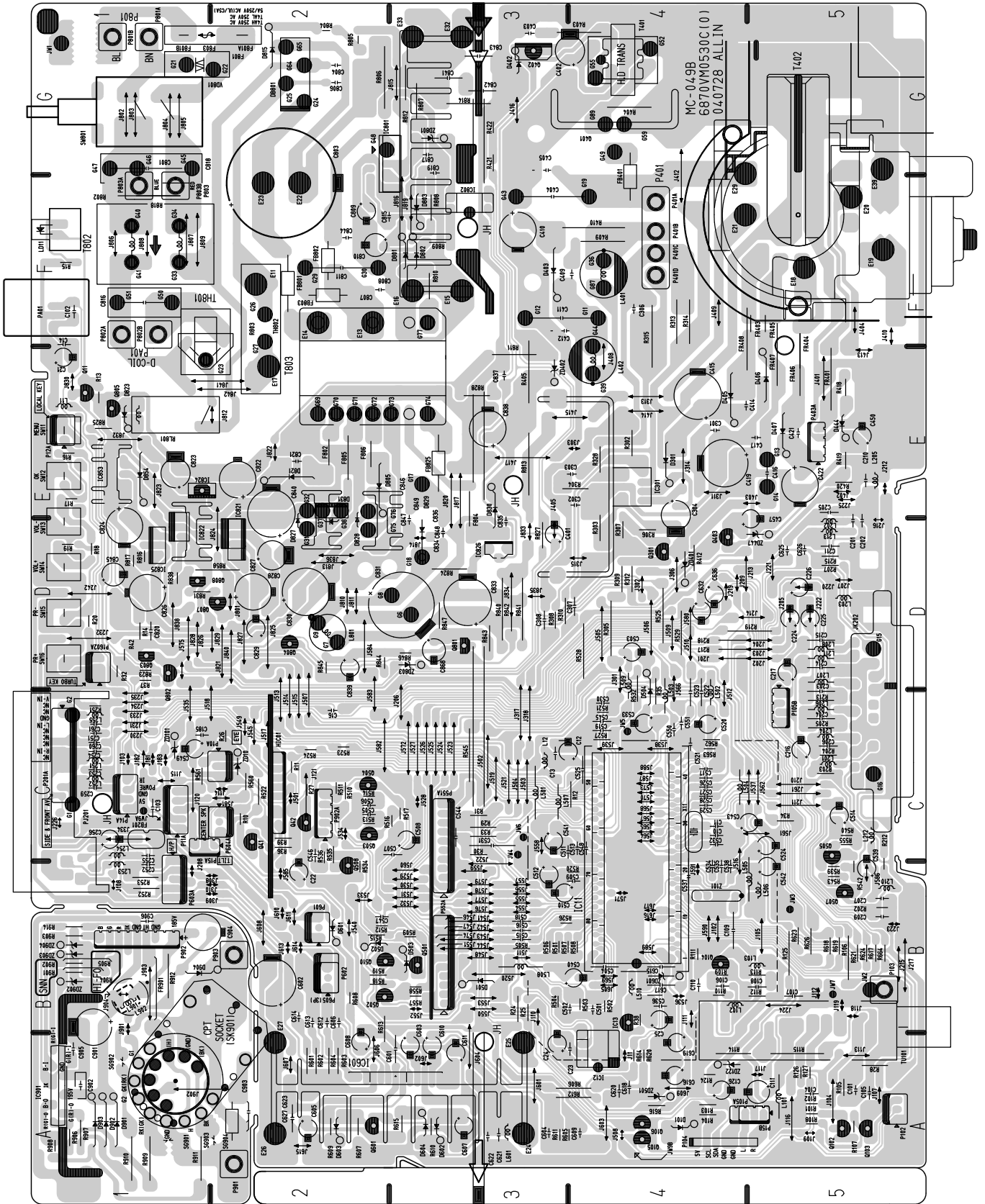

COMPONENT LOCATION GUIDE

C10.....C4	C501.....B4	C626.....D5	D823.....E1	J231.....C1	J541.....B3	J810.....D2	R19.....D1	R421.....F3	R805.....G2
C11.....C4	C502.....B4	C627.....A2	D827.....D2	J232.....D1	J542.....B3	J811.....D2	R20.....D1	R422.....G3	R806.....G3
C12.....C4	C503.....D4	C632.....D4	D828.....D2	J233.....C1	J543.....B3	J812.....E2	R24.....B3	R501.....B3	R807.....G3
C13.....C3	C504.....B4	C636.....D4	D829.....D3	J234.....C1	J544.....B3	J813.....D2	R25.....B3	R502.....B4	R808.....F3
C14.....F1	C505.....C3	C801.....G1	D830.....E3	J235.....C1	J545.....C2	J814.....D3	R26.....C2	R503.....B4	R809.....F3
C16.....C2	C506.....C3	C803.....F2	D854.....E1	J242.....D1	J546.....B3	J815.....G3	R27.....C2	R504.....B3	R810.....F3
C21.....E1	C507.....C3	C804.....G2	D901.....A1	J261.....C5	J547.....B3	J816.....F3	R28.....A5	R505.....B3	R811.....E3
C22.....B2	C508.....C3	C806.....G2	D902.....A1	J301.....C4	J548.....B3	J817.....D3	R29.....C3	R506.....B3	R812.....G3
C23.....A4	C509.....B4	C807.....F3	D903.....A1	J302.....D4	J549.....C2	J819.....F3	R30.....C3	R507.....B4	R813.....E3
C24.....A3	C510.....B3	C808.....F3	D904.....B2	J303.....E4	J550.....B3	J820.....D3	R31.....C3	R508.....B4	R814.....G3
C25.....B4	C511.....C4	C809.....F2	DB801.....G2	J306.....D4	J551.....B3	J821.....D2	R32.....D1	R509.....B3	R816.....D1
C101.....A5	C512.....B3	C810.....F2	HIC01.....C2	J308.....B2	J552.....B3	J822.....E2	R33.....C3	R510.....C2	R817.....D1
C102.....F1	C513.....C4	C811.....D2	IC11.....B4	J309.....B2	J553.....B3	J823.....E1	R34.....C5	R511.....C2	R818.....F1
C103.....C1	C514.....C5	C815.....F3	IC12.....A4	J310.....B2	J554.....B3	J824.....D2	R35.....C4	R512.....B3	R823.....D1
C104.....A5	C515.....B3	C816.....F1	IC13.....B4	J311.....E4	J555.....B3	J825.....D2	R36.....C2	R513.....C3	R824.....D3
C105.....A5	C516.....B3	C817.....G3	IC301.....E4	J313.....E4	J556.....B3	J826.....D2	R37.....D1	R514.....C3	R825.....E1
C106.....B4	C517.....C4	C818.....G1	IC601.....A3	J314.....E4	J557.....B3	J827.....D2	R38.....B4	R515.....B3	R827.....D3
C107.....B5	C518.....B3	C819.....G3	IC801.....G2	J315.....D4	J558.....C3	J828.....D1	R39.....C2	R516.....C3	R828.....E3
C108.....B5	C519.....C4	C820.....D1	IC802.....F3	J317.....C3	J559.....B3	J829.....D2	R42.....D1	R517.....C3	R831.....D2
C109.....B4	C520.....C4	C821.....E2	IC821.....D2	J318.....C3	J560.....B3	J830.....E1	R101.....A5	R518.....B3	R838.....D1
C110.....B4	C521.....C4	C822.....E2	IC822.....E1	J334.....C1	J561.....C5	J832.....E1	R102.....A5	R519.....B3	R840.....D3
C111.....A5	C522.....C4	C823.....E1	IC824.....E1	J401.....E5	J562.....C5	J833.....D3	R103.....A4	R520.....B4	R841.....D3
C126.....A4	C523.....C4	C824.....D1	IC825.....D1	J402.....E5	J564.....C4	J834.....D3	R104.....A4	R521.....C4	R842.....D3
C185.....C1	C524.....C5	C826.....D1	IC826.....D3	J403.....E5	J565.....C4	J835.....D3	R105.....A5	R522.....C2	R843.....D3
C201.....D5	C525.....C4	C827.....D2	IC853.....E1	J404.....F5	J566.....C4	J836.....D2	R106.....B5	R523.....C2	R844.....D3
C202.....D5	C526.....C4	C828.....D2	IC901.....A1	J405.....D3	J567.....C4	J838.....D1	R107.....A5	R524.....C2	R845.....D2
C203.....C5	C527.....C4	C829.....D2	J11.....A4	J408.....E4	J568.....C4	J840.....D2	R108.....A5	R525.....D4	R846.....D3
C204.....C5	C528.....C4	C830.....D2	J102.....B4	J409.....F4	J569.....B4	J841.....E2	R109.....B4	R526.....B4	R847.....D3
C205.....E5	C529.....C4	C831.....D3	J103.....C1	J410.....F5	J570.....C4	J842.....E2	R110.....B4	R527.....C4	R858.....D1
C206.....C5	C530.....C4	C833.....D3	J104.....A5	J412.....F4	J571.....B4	J901.....A1	R111.....B4	R528.....D4	R901.....B1
C207.....B5	C531.....C3	C834.....D3	J105.....B5	J413.....E5	J572.....C3	J902.....A2	R112.....B5	R529.....D4	R902.....B1
C209.....B5	C532.....C4	C835.....E3	J107.....A5	J414.....E4	J573.....C4	J903.....B1	R113.....B5	R532.....C4	R903.....B1
C210.....E5	C533.....C4	C836.....E3	J108.....B1	J415.....E3	J574.....B3	J904.....B1	R114.....A5	R534.....B2	R904.....B1
C211.....D5	C534.....B4	C837.....E3	J109.....A5	J416.....G3	J575.....D1	JK202.....C5	R115.....A5	R535.....B2	R905.....B1
C214.....D5	C535.....B4	C838.....E3	J110.....B3	J417.....E3	J576.....B3	JP1.....G2	R124.....A4	R536.....B2	R906.....A1
C215.....D5	C536.....B4	C839.....D2	J111.....B4	J501.....C2	J577.....B3	JP2.....F2	R125.....B5	R539.....B5	R907.....A1
C216.....C5	C537.....B4	C840.....E2	J112.....B5	J502.....C3	J578.....B3	JW1.....G1	R126.....A5	R540.....C5	R908.....A1
C217.....D5	C538.....B4	C841.....G3	J113.....A5	J503.....C3	J579.....B3	JW2.....B5	R127.....A5	R542.....C5	R909.....A1
C224.....D5	C539.....C5	C842.....G3	J114.....C2	J504.....C3	J580.....D4	Q11.....E1	R202.....B5	R543.....B5	R910.....A1
C225.....D5	C540.....B4	C843.....G3	J115.....C1	J505.....D4	J581.....C2	Q41.....C2	R203.....C5	R545.....C3	R911.....A2
C226.....D5	C541.....C3	C844.....F2	J116.....A5	J506.....D4	J582.....C3	Q42.....C2	R204.....C5	R555.....C5	R912.....B1
C251.....C1	C542.....B5	C845.....D1	J117.....A5	J507.....C2	J583.....D2	Q102.....A5	R205.....C5	R557.....B3	R914.....B1
C252.....B1	C543.....C5	C846.....E3	J118.....B5	J508.....A4	J584.....D2	Q103.....A5	R207.....D5	R558.....B3	RL801.....E1
C253.....C1	C544.....C3	C847.....D3	J119.....B5	J509.....D4	J585.....B2	Q104.....B4	R212.....C5	R560.....C2	T401.....G4
C254.....C1	C545.....C4	C848.....D3	J120.....C1	J510.....D4	J586.....C5	Q105.....A4	R213.....C5	R561.....C2	T402.....F5
C255.....C1	C546.....B2	C849.....D3	J121.....C2	J511.....B3	J587.....C4	Q106.....A4	R215.....D5	R562.....C4	T802.....F1
C256.....C1	C547.....B2	C868.....D3	J181.....C1	J512.....C4	J588.....C4	Q301.....D4	R217.....D5	R563.....C4	T803.....F3
C259.....C1	C548.....C4	C901.....B1	J182.....C1	J513.....C2	J589.....B4	Q401.....G4	R218.....D5	R601.....A2	TH801.....F1
C260.....C1	C549.....C1	C902.....A1	J183.....C1	J514.....C2	J590.....B4	Q402.....G3	R219.....D5	R602.....A2	TH802.....F2
C261.....C1	C550.....C4	C903.....A2	J201.....D5	J515.....C2	J591.....C4	Q403.....D4	R251.....C1	R603.....A2	TU101.....B5
C301.....E4	C551.....C4	C904.....B2	J202.....D5	J516.....B4	J601.....A3	Q501.....B3	R252.....B1	R604.....A2	VD801.....G1
C302.....E4	C601.....A3	C905.....A1	J203.....D5	J517.....C2	J602.....A3	Q502.....B2	R253.....B1	R605.....A4	X11.....C4
C303.....E4	C602.....B2	C906.....B1	J204.....D5	J518.....C2	J603.....A4	Q503.....C2	R302.....E4	R606.....A4	Z101.....B4
C304.....D4	C603.....A3	D101.....A4	J205.....D5	J519.....C3	J604.....A3	Q504.....C2	R303.....D4	R607.....A2	ZD10.....C2
C306.....F4	C604.....A3	D301.....E4	J206.....C3	J520.....B3	J605.....B4	Q505.....C5	R304.....E4	R608.....B2	ZD101.....C1
C307.....D4	C605.....A2	D402.....G3	J207.....D5	J521.....C3	J606.....A2	Q507.....B5	R305.....D4	R609.....A2	ZD122.....A4
C308.....D3	C606.....B2	D403.....F3	J208.....C1	J522.....B3	J607.....A2	Q508.....B2	R306.....D4	R610.....A3	ZD401.....D4
C401.....D3	C607.....A3	D405.....E4	J209.....D4	J523.....C3	J608.....B2	Q510.....B2	R307.....D4	R611.....A3	ZD402.....E3
C402.....G4	C608.....B2	D406.....E5	J210.....C5	J524.....C3	J609.....A4	Q601.....A2	R308.....D3	R612.....A4	ZD447.....D5
C403.....G3	C609.....A4	D407.....E5	J211.....C5	J525.....C3	J610.....B2	Q801.....D3	R309.....D4	R613.....B3	ZD501.....A4
C404.....F3	C610.....A3	D444.....E5	J212.....E5	J526.....C3	J611.....B2	Q802.....D1	R310.....D4	R614.....A4	ZD601.....B4
C405.....G3	C611.....A3	D501.....B3	J213.....D5	J527.....C3	J613.....B2	Q803.....D1	R312.....D4	R615.....A3	ZD801.....G3
C409.....F4	C612.....B2	D502.....B2	J214.....D5	J528.....C3	J614.....B2	Q804.....D2	R313.....F4	R616.....A4	ZD803.....D3
C410.....F3	C613.....B2	D503.....B3	J215.....B5	J529.....B3	J615.....A2	Q805.....E1	R314.....F4	R617.....B5	ZD902.....B1
C411.....F3	C614.....B2	D504.....D4	J216.....D5	J530.....B3	J616.....B4	Q807.....D2	R315.....F4	R618.....B5	ZD903.....B1
C412.....F4	C615.....B4	D601.....B2	J217.....B5	J531.....B3	J617.....B4	Q808.....D2	R328.....E4	R619.....B5	ZD904.....B1
C414.....E5	C616.....A4	D602.....A3	J219.....D4	J532.....B3	J801.....D2	R10.....C2	R403.....G4	R620.....A4	
C415.....E4	C617.....B4	D603.....A2	J220.....D5	J533.....B2	J802.....G1	R11.....C2	R404.....G4	R621.....B5	
C416.....E5	C618.....A4	D604.....A3	J221.....D5	J534.....C2	J803.....G1	R12.....C4	R405.....F3	R623.....B5	
C417.....E5	C619.....A4	D801.....F3	J222.....D5	J535.....C1	J804.....G1	R13.....E1	R409.....F4	R624.....B5	
C419.....E4	C620.....A4	D802.....F3	J223.....B5	J536.....B4	J805.....G1	R14.....D1	R410.....F4	R626.....B5	
C421.....E5	C621.....A3	D803.....F3	J224.....B5	J537.....C5	J806.....F1	R15.....F1	R412.....D4	R664.....B5	
C422.....E5	C622.....A3	D805.....E3	J225.....E5	J538.....C4	J807.....F1	R16.....E1	R418.....E5	R802.....F1	
C450.....E5	C623.....A2	D815.....G2	J226.....C1	J539.....C4	J808.....F1	R17.....E1	R419.....E5	R803.....E2	
C457.....D5	C625.....D5	D821.....E2	J230.....C1	J540.....B2	J809.....F2	R18.....D1	R420.....E5	R804.....G2	

SIDE A/V

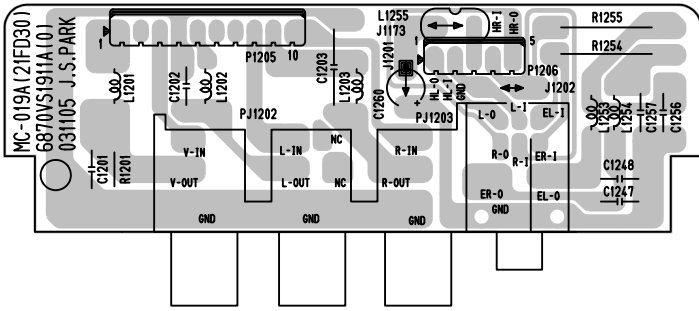

POWER SW

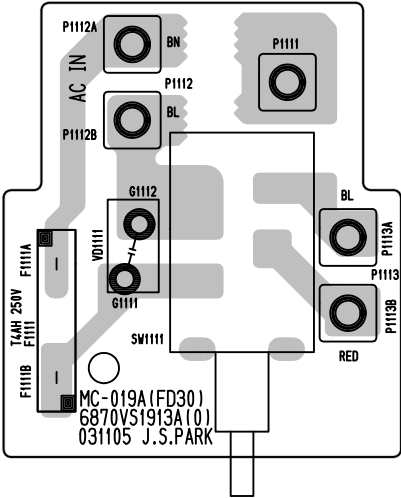

BLOCK DIAGRAM

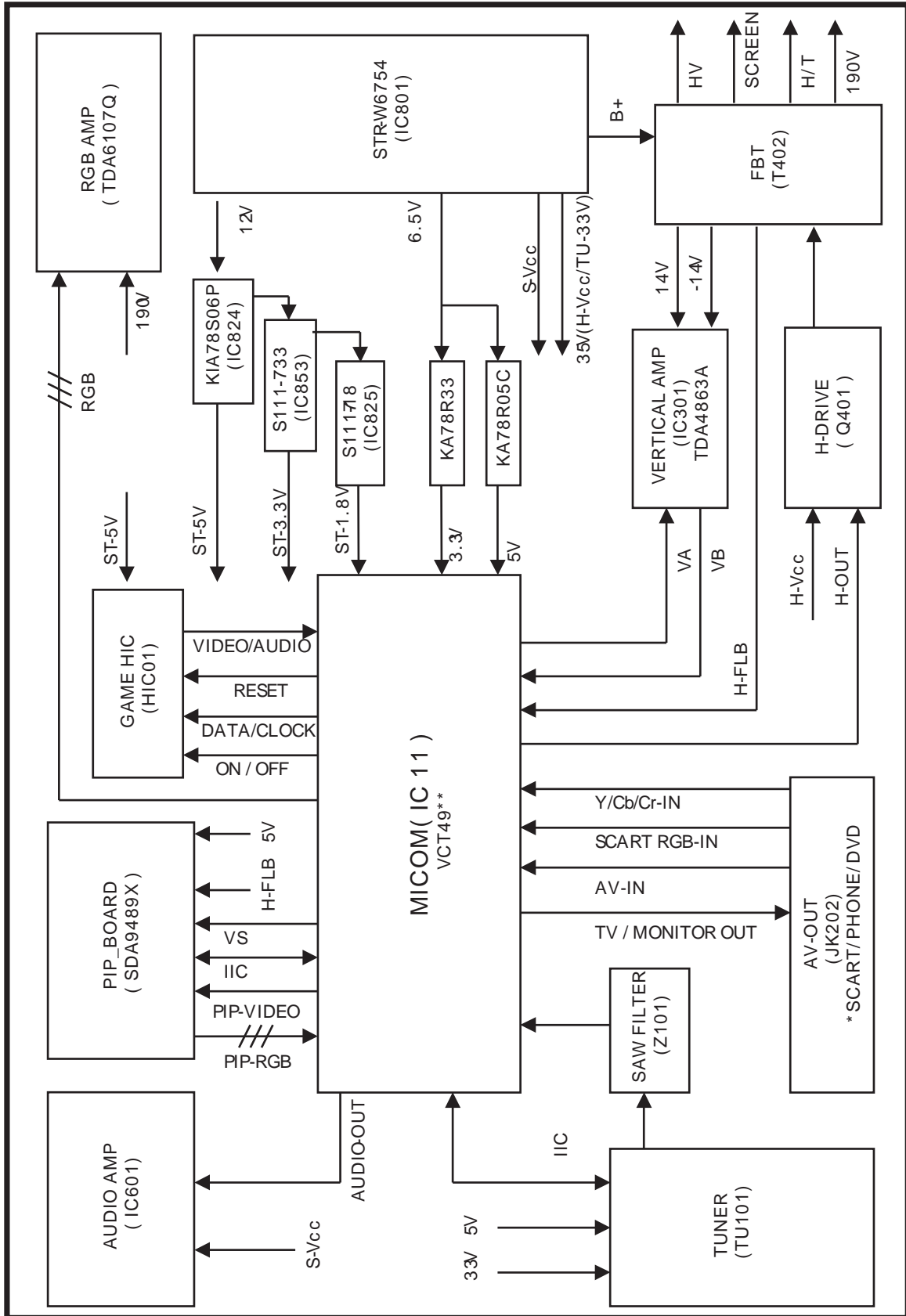

EXPLODED VIEW

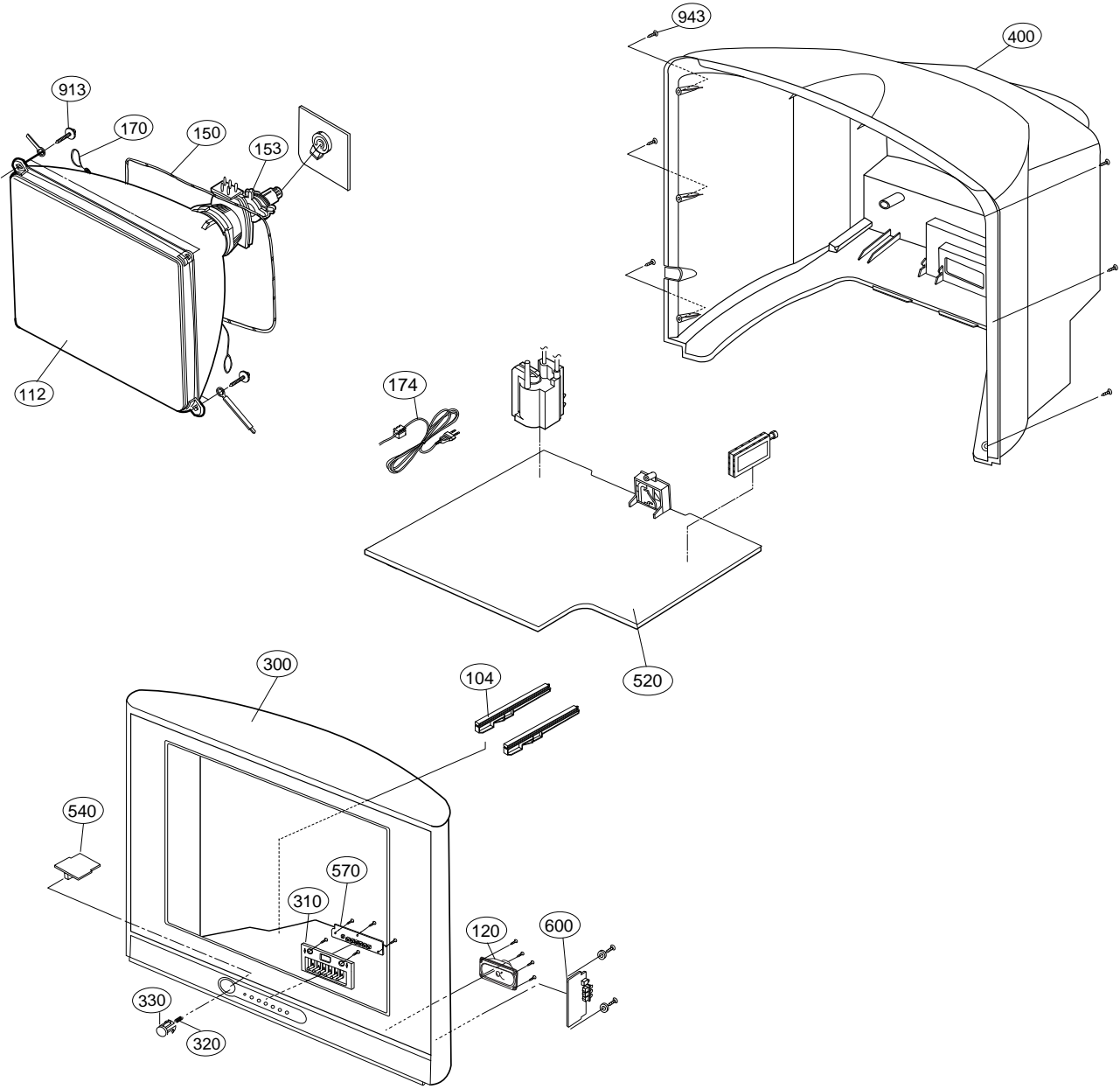

EXPLODED VIEW PARTS LIST

The components identified by mark Δ is critical for safety.
Replace only with part number specified.

LOCA. No.	PART No.	DESCRIPTIONS
104	343-B52A	SUPPORTER, PCB(CF-14F20)
Δ 112	6334V21004B	CPT, A51QDX992X 0G[V] 0G[H] SSDI BARE
120	120-C93G	SPEAKER,GENERAL C091P06K1459 8 OHM 5/ 7W 80 DB 90*50
Δ 150	150-D02T	COIL,DEGAUSSING,AL 21" 56T 12 OHM
	150-D02X	COIL,DEGAUSSING CU 21" 60TURN 12 OHM D02N (NYLON)
Δ 153	6150V-1019C	DY(DEFLECTION YOKE), DIF-2192AA(NF5) 21" SAMSUNG
Δ 170	170-A01N	CPT EARTH, 21" 64T 2LUG 1P HSG CL-21Q20ET(PC-99DA)
Δ 174	174-009Q	POWER CORD, OWER(W/HOLD,HOUSING)L=300,4.0
300	3091V00624E	CABINET ASSEMBLY, RD-21FD35V MC049B VN-SET
310	5020V00883C	BUTTON, CONTROL RT-21FD35V ABS 7KEY 117A
320	320-062E	SPRING, KNOB
330	5020V00884B	BUTTON, POWER RT-21FD35V ABS 1KEY 117A
400	3809V00428G	BACK COVER ASSEMBLY, RT-21FD35V DVD(1PHONE) 8G068 VN->SET
	3809V00428H	BACK COVER ASSEMBLY, RT-21FD35M 1PHONE 049B(8G068) VN->SET
520	6871VMM910L	PWB ASSEMBLY,MAIN MC049B RT-21FD35VX.LTSLVC8, VN-CASA-S
	6871VMM910R	PWB ASSEMBLY,MAIN MC049B RT-21FD35M.LLSLVU8, VN-MOS
	6871VMMT79T	PWB ASSEMBLY,MAIN MC049B RT-21FD35V.LTSLVV8 VN8 DVD
	6871VMMT79U	PWB ASSEMBLY,MAIN MC049B RT-21FD35VX.LTSLVS8 VN-S&E PH
540	6871VSMABDL	PWB ASSEMBLY,SUB POWER MC049B 21FD35,VN-4P,AC-SUB
	6871VSMABDY	PWB ASSEMBLY,SUB POWER MC049B 21FD35,VN-EXPORT,AC-SUB
570	6871VSMABDK	PWB ASSEMBLY,SUB CONT MC049B 21FD35,VN-4P,KEY-SUB
	6871VSMABDX	PWB ASSEMBLY,SUB CONT MC049B 21FD35,VN-EXPORT,KEY-SUB
600	6871VSMABDJ	PWB ASSEMBLY,SUB A/V MC049B 21FD35V/R,VN-4P,SIDE-AV
	6871VSMABDW	PWB ASSEMBLY,SUB A/V MC049B 21FD35V/R,VN-EXPORT,SIDE-AV
	6871VSMJ79E	PWB ASSEMBLY,SUB A/V MC049B 21FD35M,VN-EXPORT
913	332-057J	SCREW,DRAWING PAN WASHER 6mm 35mm
943	1PTF0403116	SCREW TAP TITE(P),TRUSS HEAD + D4.0 L16.0 MSWR3/FZB

REPLACEMENT PARTS LIST

For Capacitor & Resistors, the characters at 2nd and 3rd digit in the P/No. means as follows;	CC, CX, CK, CN : Ceramic CQ : Polyester CE : Electrolytic	RD : Carbon Film RS : Metal Oxide Film RN : Metal Film RF : Fusible
---	---	--

LOCA. NO	PART NO	DESCRIPTION
IC		
D827	0IMCRKE018A	KIA78R05API KEC 4P TO220 ST 5V 1A
IC11	0IMCRMN031B	VCT4934F MICRONAS 88PIN DIP ST
IC12	0IMMRSG036C	M24C16-WBN6 8PIN PDIP ST 16M
IC13	0IFA752700A	KA75270Z 3 TP RE-SET IC MC-007
IC301	0IPH610700B	TDA6107JF/N3 9P ST RGB AMP
IC601	0IPMGSA021C	LA42152 SANYO 13P ST 15W 2CH AUDIO AMP
IC802	0IL1817000G	LTV817M-VB 4P,DIP BK PHOTO COUPLER
IC821	0IMCRKE019A	KIA78R33API KEC 4P TO220 ST 3.3V 1A
IC822	0IPMGSK016B	STR-W6754 SANKEN 7PIN T0220F ST
IC824	0IMCRKE020A	KIA78S06P KEC 3P TO-92 TP 6V 0.15A
IC825	0IMCRAU003A	S1117-18PIC 3P TO220F ST 1.8V 1A
IC826	0ISK110000A	SE110N(LF12) 3P 110V ERROR AMP
IC853	0IPMGPH002A	TDA4863A 7P SOT524-1 ST
IC901	0IMCRAU004A	S1117-33PIC 3P TO220F ST 3.3V 1A
TRANSISTOR		
Q104	0TR319709AB	KTC3197,TP(KTC388A),KEC
Q1101	0TR198009BA	2SA1980Y TP AUK
Q301	0TR198009BA	2SA1980Y TP AUK
Q401	0TRSA10004A	TT2170LS-YB11 ST TO-220FM 1500V 5A
Q402	0TR233109AA	KSC2331-Y TP SAMSUNG TO-92L -
Q501	0TR198009BA	2SA1980Y TP AUK
Q502	0TR198009BA	2SA1980Y TP AUK
Q503	0TR198009BA	2SA1980Y TP AUK
Q504	0TR198009BA	2SA1980Y TP AUK
Q505	0TR534309AA	2SC5343Y TP AUK
Q507	0TR198009BA	2SA1980Y TP AUK
Q508	0TR534309AA	2SC5343Y TP AUK
Q510	0TR534309AA	2SC5343Y TP AUK
Q601	0TR198009BA	2SA1980Y TP AUK
Q802	0TR534309AA	2SC5343Y TP AUK
Q803	0TR102009AB	KRC102M(KRC1202) KEC TP NA NA NA
Q807	0TR127409AB	KTA1274-Y TO-92L TP KEC
Q808	0TR102009AB	KRC102M(KRC1202) KEC TP NA NA NA
DIODE		
D301	0DD400509AA	1N4005 TP KEC
D403	0DRTW00164B	RGP15J TP52 DO15 .V 1.5A 50A 250NSEC 100UA
D405	0DRTW00164B	RGP15J TP52 DO15 .V 1.5A 50A 250NSEC 100UA
D406	0DRTW00164B	RGP15J TP52 DO15 .V 1.5A 50A 250NSEC 100UA
D407	0DRTW00164A	RGP10J TP52 DO41 .V 1A 30A .SEC 5UA
D501	0DD414809ED	1N4148 TP GRANDE
D502	0DD414809ED	1N4148 TP GRANDE
D503	0DD414809ED	1N4148 TP GRANDE
D504	0DD414809ED	1N4148 TP GRANDE
D601	0DD414809ED	1N4148 TP GRANDE
D602	0DD414809ED	1N4148 TP GRANDE

LOCA. NO	PART NO	DESCRIPTION
D603	0DD414809ED	1N4148 TP GRANDE
D604	0DD414809ED	1N4148 TP GRANDE
D801	0DD100009AM	EU1ZV(1) TP SANKEN
D802	0DD100009AM	EU1ZV(1) TP SANKEN
D803	0DD100009AM	EU1ZV(1) TP SANKEN
D815	0DD060009AC	TVR06J TP - 600V 250NSEC -
D821	0DRTW00164A	RGP10J TP52 DO41 .V 1A 30A .SEC 5UA
D828	0DRTW00141A	SFAF504G ST ITO220 200V 5A .A .SEC 10UA
D829	0DD300009AC	RU3AMV(1) TP SANKEN
D830	0DRTW00164A	RGP10J TP52 DO41 .V 1A 30A .SEC 5UA
D854	0DD060009AC	TVR06J TP - 600V 250NSEC
D901	0DR210009AC	BAV21 TP DO35 200V 0.2A 1A 50SEC 100A
D902	0DR210009AC	BAV21 TP DO35 200V 0.2A 1A 50SEC 100A
D903	0DR210009AC	BAV21 TP DO35 200V 0.2A 1A 50SEC 100A
D904	0DR140049AC	1N4004A T-81 TP DO41 500V 1.0A 30A - 10UA
DB801	0DRTW00131A	D2SB60 ST GBL 600V 1.5A .A .SEC 10UA
IC801	0DRTW00141A	SFAF504G ST ITO220 200V 5A .A .SEC 10UA
LD1111	0DL100000AE	LED,SA5711(DL-1LO) BK AMBER
ZD101	0DZ510009BF	GDZ5.1B TP DO34 0.5W 5.1V 0.02A
ZD122	0DZ330009DG	GDZJ33B TP DO34 0.5W 33.0V
ZD401	0DZ510009BF	GDZ5.1B TP DO34 0.5W 5.1V 0.02A
ZD402	0DZ240009CG	MTZJ24B TP DO34 - 24V 5UA
ZD501	0DZ110009AD	MTZJ11B TP DO34 - 11V 5UA
ZD601	0DZ820009AH	MTZJ8.2B TP DO34 - 8.2V 5UA
ZD801	0DZ620009AH	MTZJ6.2A TP DO34 0.5W 6.2V 150UA
ZD803	0DZ510009BF	GDZ5.1B TP DO34 0.5W 5.1V 0.02A
CAPACITOR		
C10	0CX2200K409	22P 50V J SL TA52
C101	0CQ2721N409	0.0027UF D 100V 5% PE TP5
C103	0CN1040K949	0.1UF D 50V 80%,-20% F(Y5V) TA52
C104	0CN1030F679	10000P 16V M Y TA52
C106	0CN1030F679	10000P 16V M Y TA52
C107	0CN1030F679	10000P 16V M Y TA52
C108	0CN1030F679	10000P 16V M Y TA52
C109	0CN1030F679	10000P 16V M Y TA52
C11	0CX2200K409	22P 50V J SL TA52
C110	0CN1030F679	10000P 16V M Y TA52
C111	0CE227DD618	220UF STD 10V M FL TP5
C1121	0CE107DD618	100UF STD 10V M FL TP5
C12	0CE107DD618	100UF STD 10V M FL TP5
C126	0CE475DK618	4.7UF STD 50V 20% FL TP 5
C1260	0CE226DF618	22UF STD 16V M FL TP5
C13	0CN1040K949	0.1UF D 50V 80%,-20% F(Y5V) TA52
C185	0CN1040K949	0.1UF D 50V 80%,-20% F(Y5V) TA52
C201	0CN1010K519	100P 50V K B TA52
C202	0CN1010K519	100P 50V K B TA52
C205	0CN4710K519	470P 50V K B TA52
C211	0CN4710K519	470P 50V K B TA52

For Capacitor & Resistors, the characters at 2nd and 3rd digit in the P/No. means as follows;	CC, CX, CK, CN : Ceramic CQ : Polyester CE : Electrolytic	RD : Carbon Film RS : Metal Oxide Film RN : Metal Film RF : Fusible
--	---	--

LOCA. NO	PART NO	DESCRIPTION
C214	0CN4710K519	470P 50V K B TA52
C215	0CN4710K519	470P 50V K B TA52
C216	0CE226DF618	22UF STD 16V M FL TP5
C217	0CE226DF618	22UF STD 16V M FL TP5
C23	0CN1040K949	0.1UF D 50V 80%,-20% F(Y5V) TA52
C24	0CE226DD618	22UF STD 10V 20% FL TP 5
C25	0CE105DK618	1UF STD 50V M FL TP5
C253	0CN4710K519	470P 50V K B TA52
C254	0CN1010K519	100P 50V K B TA52
C259	0CN1010K519	100P 50V K B TA52
C260	0CN4710K519	470P 50V K B TA52
C303	0CQ1041N409	0.1000UF 100V J PE TP
C304	0CE107DJ618	100UF STD 35V M FL TP5
C306	0CQ3331N509	0.033UF D 100V 10% PE TP5
C402	0CE475DK618	4.7UF STD 50V 20% FL TP 5
C403	0CQ1521N509	0.0015UF D 100V 10% PE TP5
C404	181-015E	MPP 1600V 0.0068UF H
C405	181-091Y	R 680PF 2KV 10%,-10% R/TP TP7.5
C409	0CK8210W515	820P 500V K B TS
C410	0CE475DP618	4.7UF STD 160V 20% FL TP 5
C411	181-013P	MPP 400V 0.33UF J
C414	0CK2710W515	270P 500V K B TS
C415	0CE108DH618	1000UF STD 25V M FL TP5
C416	181-009R	PP 200V 0.022UF K
C417	0CK2710W515	270P 500V K B TS
C419	0CE108DH618	1000UF STD 25V M FL TP5
C421	0CK2710W515	270P 500V K B TS
C422	0CE475DR618	4.7UF STD 250V 20% FL TP 5
C501	0CQ6831N509	0.068UF D 100V 10% PE TP5
C502	0CQ6831N509	0.068UF D 100V 10% PE TP5
C503	0CE475DK618	4.7UF STD 50V 20% FL TP 5
C504	0CN1040K949	0.1UF D 50V 80%,-20% F(Y5V) TA52
C505	0CN2710K519	270P 50V K B TA52
C506	0CN2710K519	270P 50V K B TA52
C507	0CN1040K949	0.1UF D 50V 80%,-20% F(Y5V) TA52
C508	0CE107DD618	100UF STD 10V M FL TP5
C509	0CN1040K949	0.1UF D 50V 80%,-20% F(Y5V) TA52
C510	0CE475DK618	4.7UF STD 50V 20% FL TP 5
C511	0CN1040K949	0.1UF D 50V 80%,-20% F(Y5V) TA52
C512	0CE107DD618	100UF STD 10V M FL TP5
C513	0CN1040K949	0.1UF D 50V 80%,-20% F(Y5V) TA52
C514	0CE107DD618	100UF STD 10V M FL TP5
C515	0CN1040K949	0.1UF D 50V 80%,-20% F(Y5V) TA52
C516	0CN1040K949	0.1UF D 50V 80%,-20% F(Y5V) TA52
C517	0CN1040K949	0.1UF D 50V 80%,-20% F(Y5V) TA52
C518	0CN1040K949	0.1UF D 50V 80%,-20% F(Y5V) TA52
C519	0CN1010K519	100P 50V K B TA52
C520	0CE107DD618	100UF STD 10V M FL TP5
C521	0CN1040K949	0.1UF D 50V 80%,-20% F(Y5V) TA52
C523	0CN1040K949	0.1UF D 50V 80%,-20% F(Y5V) TA52
C524	0CE107DD618	100UF STD 10V M FL TP5
C525	0CN3310K519	330P 50V K B TA52

LOCA. NO	PART NO	DESCRIPTION
C526	0CN1040K949	0.1UF D 50V 80%,-20% F(Y5V) TA52
C527	0CN1040K949	0.1UF D 50V 80%,-20% F(Y5V) TA52
C528	0CN1040K949	0.1UF D 50V 80%,-20% F(Y5V) TA52
C529	0CN1040K949	0.1UF D 50V 80%,-20% F(Y5V) TA52
C530	0CN1010K519	100P 50V K B TA52
C531	0CX3300K409	33P 50V J SL TA52
C532	0CN1040K949	0.1UF D 50V 80%,-20% F(Y5V) TA52
C533	0CE107DD618	100UF STD 10V M FL TP5
C534	0CN1040K949	0.1UF D 50V 80%,-20% F(Y5V) TA52
C535	0CN1040K949	0.1UF D 50V 80%,-20% F(Y5V) TA52
C536	0CN1040K949	0.1UF D 50V 80%,-20% F(Y5V) TA52
C537	0CN1040K949	0.1UF D 50V 80%,-20% F(Y5V) TA52
C538	0CN1040K949	0.1UF D 50V 80%,-20% F(Y5V) TA52
C540	0CE107DD618	100UF STD 10V M FL TP5
C541	0CE107DD618	100UF STD 10V M FL TP5
C542	0CE107DD618	100UF STD 10V M FL TP5
C543	0CE107DD618	100UF STD 10V M FL TP5
C545	0CX2200K409	22P 50V J SL TA52
C546	0CN1510K519	150P 50V K B TA52
C547	0CN2710K519	270P 50V K B TA52
C548	0CN1040K949	0.1UF D 50V 80%,-20% F(Y5V) TA52
C550	0CN1040K949	0.1UF D 50V 80%,-20% F(Y5V) TA52
C602	0CE108DH618	1000UF STD 25V M FL TP5
C603	0CE475DK618	4.7UF STD 50V 20% FL TP 5
C604	0CQ8221N519	0.0082UF D 100V 10% PE NI TP5
C605	0CE476DF618	47UF STD 16V M FL TP5
C606	181-007C	MPE ECQ-V1H104JL3(TR), 50V 0.1UF
C607	0CE106DF618	10UF STD 16V M FL TP5
C608	0CE106DF618	10UF STD 16V M FL TP5
C609	0CQ8221N519	0.0082UF D 100V 10% PE NI TP5
C610	0CE475DK618	4.7UF STD 50V 20% FL TP 5
C611	0CE476DH618	47UF STD 25V 20% FL TP 5
C612	181-007C	MPE ECQ-V1H104JL3(TR), 50V 0.1UF
C613	181-007C	MPE ECQ-V1H104JL3(TR), 50V 0.1UF
C614	181-007C	MPE ECQ-V1H104JL3(TR), 50V 0.1UF
C615	0CN1040K949	0.1UF D 50V 80%,-20% F(Y5V) TA52
C616	0CE476DD618	47UF STD 10V 20% FL TP 5
C617	0CN1040K949	0.1UF D 50V 80%,-20% F(Y5V) TA52
C618	0CN1010K519	100P 50V K B TA52
C619	0CE335DK618	3.3UF STD 50V 20% FL TP 5
C620	0CN1010K519	100P 50V K B TA52
C625	0CQ5631N409	0.056UF D 100V 5% PE TP5
C626	0CQ5631N409	0.056UF D 100V 5% PE TP5
C627	0CK1030K945	0.01UF 50V Z F TR
C632	0CQ5631N409	0.056UF D 100V 5% PE TP5
C803	0CE337KV6A0	330UF SLT 450V 20% VNSN BULK
C804	0CK10201515	1000P 1KV K B TS
C806	0CK10201515	1000P 1KV K B TS
C807	181-091X	R 560PF 2KV 10%,-10% R/TP TP7.5
C809	0CE105DK618	1UF STD 50V M FL TP5
C810	0CE336DK618	33UF STD 50V M FL TP5
C811	181-011B	0.001UF D 1.6KV J M/PP NI FM20

For Capacitor & Resistors, the characters at 2nd and 3rd digit in the P/No. means as follows;

CC, CX, CK, CN : Ceramic	RD : Carbon Film
CQ : Polyester	RS : Metal Oxide Film
CE : Electrolytic	RN : Metal Film
	RF : Fusible

LOCA. NO	PART NO	DESCRIPTION
C815	0CK8210K515	820P 50V K B TS
C816	0CQZVBK002A	A.C 275V 0.1UF M (S=15)
C817	0CK1040K945	0.1UF 50V Z F TR
C818	0CQZVBK002C	A.C 275V 0.22UF K (S=22.5)
C819	0CK1520K515	1500P 50V K B TS
C820	0CN1040K949	0.1UF D 50V 80%,-20% F(Y5V) TA52
C821	0CK4710W515	470PF 500V K B TR
C822	0CE477DH618	470UF STD 25V M FL TP5
C823	0CE477DD618	470UF STD 10V M FL TP5
C824	0CE108DD618	1000UF STD 10V M FL TP5
C826	0CE108DD618	1000UF STD 10V M FL TP5
C827	0CE108DD618	1000UF STD 10V M FL TP5
C828	0CE477DD618	470UF STD 10V M FL TP5
C829	0CE335CK636	3.3UF SHL,SD 50V 20% FM5 BP(D) TP
C830	0CE108DH618	1000UF STD 25V M FL TP5
C831	0CE227DP61A	220UF STD 160V 20% FL TP 7.5
C833	0CE107CP618	100U SHL 160V M FL TP5
C835	0CK4710W515	470PF 500V K B TR
C836	0CK12202510	1200P 2KV K B S
C837	0CQ4731N509	0.047UF D 100V 10% PE TP5
C838	0CE227DK618	220UF STD 50V M FL TP5
C840	0CE228BF618	2200UF KME 16V M FL TP5
C843	181-120K	2200PF 4KV M E FMTW LEAD 4.5
C845	0CE107DD618	100UF STD 10V M FL TP5
C901	0CE475DR618	4.7UF STD 250V 20% FL TP 5
C902	0CQ1044R539	0.1UF TE 250V 10% M/PE NI TP5
C903	181-033S	2KV B 122K TP7.5
C904	0CE475DR618	4.7UF STD 250V 20% FL TP 5
COIL & INDUCTOR		
L101	0LA0102K139	INDUCTOR,AXIAL LEAD 10UH K 4*10.5 TP
L103	0LA0101K119	INDUCTOR,AXIAL LEAD 1.0UH K 2.3*3.4 TP
L1101	0LA0102K119	INDUCTOR,AXIAL LEAD 10UH K 2.3*3.4 TP
L12	0LA0101K119	INDUCTOR,AXIAL LEAD 1.0UH K 2.3*3.4 TP
L202	0LA0102K119	INDUCTOR,AXIAL LEAD 10UH K 2.3*3.4 TP
L208	0LA0102K119	INDUCTOR,AXIAL LEAD 10UH K 2.3*3.4 TP
L211	0LA0102K119	INDUCTOR,AXIAL LEAD 10UH K 2.3*3.4 TP
L213	0LA0102K119	INDUCTOR,AXIAL LEAD 10UH K 2.3*3.4 TP
L251	0LA0102K119	INDUCTOR,AXIAL LEAD 10UH K 2.3*3.4 TP
L252	0LA0102K119	INDUCTOR,AXIAL LEAD 10UH K 2.3*3.4 TP
L401	6140VE0001V	COIL,LINEARITY 60UH 0.6PHY 69.5TURN
L402	6140VB0001F	COIL,CHOKE 130UH 0.45PHY 55.5TURN
L501	0LA0102K119	INDUCTOR,AXIAL LEAD 10UH K 2.3*3.4 TP
L502	0LA0102K119	INDUCTOR,AXIAL LEAD 10UH K 2.3*3.4 TP
L503	0LA0102K119	INDUCTOR,AXIAL LEAD 10UH K 2.3*3.4 TP
L504	0LA0101K119	INDUCTOR,AXIAL LEAD 1.0UH K 2.3*3.4 TP
L505	0LA0102K119	INDUCTOR,AXIAL LEAD 10UH K 2.3*3.4 TP
L506	0LA0102K119	INDUCTOR,AXIAL LEAD 10UH K 2.3*3.4 TP
L507	0LA0101K119	INDUCTOR,AXIAL LEAD 1.0UH K 2.3*3.4 TP
L508	0LA0101K119	INDUCTOR,AXIAL LEAD 1.0UH K 2.3*3.4 TP
L509	0LA0102K119	INDUCTOR,AXIAL LEAD 10UH K 2.3*3.4 TP
L801	150-C02F	COIL,CHOKE 82UH PHY TURN

LOCA. NO	PART NO	DESCRIPTION
T401	151-C02F	TRANSFORMER, H-DRIVE,EI-19,BULK
T803	6170VMCA43J	TRANSFORMER,SMPS[COIL] EER3940 400UH
CONNECTOR		
P1205	387-A10H	10P 2.5MM 450MM H-B UL1007AWG26
P1206	387-A05H	5P 2.5MM 450MM H-B UL1007AWG26
P902	387-603E	9P 2.5MM 430MM B-B UL1007AWG26
RESISTOR		
F802	ORP0050H709	0.05 OHM 1/2 W 10% TA52
F804	ORP0050H709	0.05 OHM 1/2 W 10% TA52
F805	ORP0020J809	0.02 OHM 1 W 20% TA52
F806	ORP0020J809	0.02 OHM 1 W 20% TA52
FR401	ORF0141K607	1.4 OHM 2 W 5.00% TA62
FR403	ORP0050H709	0.05 OHM 1/2 W 10% TA52
FR404	ORP0050H709	0.05 OHM 1/2 W 10% TA52
FR405	ORP0050H709	0.05 OHM 1/2 W 10% TA52
FR901	ORF0141K607	1.4 OHM 2 W 5.00% TA62
J202	ORD1000F609	100 OHM 1/6 W 5% TA52
J203	ORD1000F609	100 OHM 1/6 W 5% TA52
J204	ORD1000F609	100 OHM 1/6 W 5% TA52
J211	ORD1000F609	100 OHM 1/6 W 5% TA52
J402	ORD0752F609	75 OHM 1/6 W 5.00% TA52
R102	ORD6801F609	6.8K OHM 1/6 W 5.00% TA52
R109	ORD0562F609	56 OHM 1/6 W 5.00% TA52
R110	ORD8200F609	820 OHM 1/6 W 5.00% TA52
R111	ORD0682F609	68 OHM 1/6 W 5.00% TA52
R1116	ORD2200F609	220 OHM 1/6 W 5.00% TA52
R1117	ORD3000F609	300 OHM 1/6 W 5.00% TA52
R1118	ORD3300F609	330 OHM 1/6 W 5.00% TA52
R1119	ORD3900F609	390 OHM 1/6 W 5% TA52
R112	ORD1501F609	1.5K OHM 1/6 W 5% TA52
R1120	ORD4300F609	430 OHM 1/6 W 5.00% TA52
R1121	ORD2201F609	2.2K OHM 1/6 W 5.00% TA52
R1122	ORD4701F609	4.7K OHM 1/6 W 5% TA52
R1123	ORD3300F609	330 OHM 1/6 W 5.00% TA52
R113	ORD3000F609	300 OHM 1/6 W 5.00% TA52
R114	ORD3303F609	330K OHM 1/6 W 5.00% TA52
R115	ORD1203F609	120K OHM 1/6 W 5.00% TA52
R12	ORD1000F609	100 OHM 1/6 W 5% TA52
R124	ORD2202F609	22K OHM 1/6 W 5% TA52
R125	ORD2700A609	270 OHM 1/2 W(7.0) 5.00% TA52
R1254	ORD2200H609	220 OHM 1/2 W 5.00% TA52
R1255	ORD2200H609	220 OHM 1/2 W 5.00% TA52
R126	ORD1000F609	100 OHM 1/6 W 5% TA52
R127	ORD1000F609	100 OHM 1/6 W 5% TA52
R204	ORD0752F609	75 OHM 1/6 W 5.00% TA52
R205	ORD0752F609	75 OHM 1/6 W 5.00% TA52
R212	ORD0752F609	75 OHM 1/6 W 5.00% TA52
R213	ORD0752F609	75 OHM 1/6 W 5.00% TA52
R24	ORD1000F609	100 OHM 1/6 W 5% TA52
R25	ORD1000F609	100 OHM 1/6 W 5% TA52

For Capacitor & Resistors, the characters at 2nd and 3rd digit in the P/No. means as follows;	CC, CX, CK, CN : Ceramic CQ : Polyester CE : Electrolytic	RD : Carbon Film RS : Metal Oxide Film RN : Metal Film RF : Fusible
--	---	--

LOCA. NO	PART NO	DESCRIPTION
R28	0RD1000F609	100 OHM 1/6 W 5% TA52
R29	0RD1000F609	100 OHM 1/6 W 5% TA52
R30	0RD3301F609	3.3K OHM 1/6 W 5.00% TA52
R302	0RN3602F409	36K OHM 1/6 W 1.00% TA52
R303	0RD2400A609	240 OHM 1/2 W(7.0) 5.00% TA52
R304	0RD0561A609	5.6 OHM 1/2 W(7.0) 5.00% TA52
R305	0RD1002F609	10K OHM 1/6 W 5% TA52
R306	0RD1002F609	10K OHM 1/6 W 5% TA52
R307	0RD3601F609	3.6K OHM 1/6 W 5.00% TA52
R308	0RN4702F409	47K OHM 1/6 W 1.00% TA52
R309	0RD2001F609	2K OHM 1/6 W 5% TA52
R31	0RD3301F609	3.3K OHM 1/6 W 5.00% TA52
R310	0RN4702F409	47K OHM 1/6 W 1.00% TA52
R312	0RD4701F609	4.7K OHM 1/6 W 5% TA52
R313	0RN0471H609	4.7 OHM 1/2 W 5.00% TA52
R314	0RN0471H609	4.7 OHM 1/2 W 5.00% TA52
R315	0RS2700K607	270 OHM 2 W 5.00% TA62
R32	0RD3301F609	3.3K OHM 1/6 W 5.00% TA52
R328	0RN3602F409	36K OHM 1/6 W 1.00% TA52
R33	0RD1000F609	100 OHM 1/6 W 5% TA52
R35	0RD1000F609	100 OHM 1/6 W 5% TA52
R37	0RD1000F609	100 OHM 1/6 W 5% TA52
R38	0RD1002F609	10K OHM 1/6 W 5% TA52
R403	0RD5600A609	560 OHM 1/2 W(7.0) 0.05 TA52
R404	0RD0332A609	33 OHM 1/2 W(7.0) 5.00% TA52
R405	0RS8200K607	820 OHM 2 W 5.00% TA62
R409	0RD1501A609	1.5K OHM 1/2 W(7.0) 5.00% TA52
R410	0RS2702K607	27K OHM 2 W 5.00% TA62
R412	0RD7501A609	7.5K OHM 1/2 W(7.0) 5.00% TA52
R42	0RD4701F609	4.7K OHM 1/6 W 5% TA52
R421	0RD3600F609	360 OHM 1/6 W 5.00% TA52
R422	0RD1002F609	10K OHM 1/6 W 5% TA52
R501	0RD3301F609	3.3K OHM 1/6 W 5.00% TA52
R502	0RN6801F409	6.8K OHM 1/6 W 1.00% TA52
R503	0RN6801F409	6.8K OHM 1/6 W 1.00% TA52
R505	0RD1000F609	100 OHM 1/6 W 5% TA52
R506	0RD2202F609	22K OHM 1/6 W 5% TA52
R507	0RD3300F609	330 OHM 1/6 W 5.00% TA52
R508	0RD1201F609	1.2K OHM 1/6 W 5% TA52
R509	0RD3600F609	360 OHM 1/6 W 5.00% TA52
R510	0RD3600F609	360 OHM 1/6 W 5.00% TA52
R511	0RD3600F609	360 OHM 1/6 W 5.00% TA52
R512	0RD0332F609	33 OHM 1/6 W 5.00% TA52
R513	0RD0332F609	33 OHM 1/6 W 5.00% TA52
R514	0RD0332F609	33 OHM 1/6 W 5.00% TA52
R515	0RD1600F609	160 OHM 1/6 W 5.00% TA52
R516	0RD1600F609	160 OHM 1/6 W 5.00% TA52
R517	0RD1600F609	160 OHM 1/6 W 5.00% TA52
R518	0RD0222F609	22 OHM 1/6 W 5.00% TA52
R519	0RD2701F609	2.7K OHM 1/6 W 5% TA52
R520	0RD1001F609	1K OHM 1/6 W 5% TA52
R521	0RD3002F609	30K OHM 1/6 W 5.00% TA52

LOCA. NO	PART NO	DESCRIPTION
R522	0RD0152F609	15 OHM 1/6 W 5.00% TA52
R523	0RD1000F609	100 OHM 1/6 W 5% TA52
R524	0RD1000F609	100 OHM 1/6 W 5% TA52
R526	0RD1201F609	1.2K OHM 1/6 W 5% TA52
R527	0RD2702F609	27K OHM 1/6 W 5.00% TA52
R530	0RD3304F609	3.3M OHM 1/6 W 5.00% TA52
R532	0RD1000F609	100 OHM 1/6 W 5% TA52
R534	0RD1201F609	1.2K OHM 1/6 W 5% TA52
R535	0RD2200F609	220 OHM 1/6 W 5.00% TA52
R536	0RD1801F609	1.8K OHM 1/6 W 5.00% TA52
R539	0RD1002F609	10K OHM 1/6 W 5% TA52
R540	0RD4702F609	47K OHM 1/6 W 5% TA52
R542	0RD8200F609	820 OHM 1/6 W 5.00% TA52
R543	0RD9100F609	910 OHM 1/6 W 5.00% TA52
R545	0RD1002F609	10K OHM 1/6 W 5% TA52
R555	0RD6800F609	680 OHM 1/6 W 5% TA52
R557	0RD3301F609	3.3K OHM 1/6 W 5.00% TA52
R558	0RD3001F609	3K OHM 1/6 W 5.00% TA52
R562	0RD0752F609	75 OHM 1/6 W 5.00% TA52
R563	0RD0752F609	75 OHM 1/6 W 5.00% TA52
R601	0RD0221A609	2.2 OHM 1/2 W(7.0) 5.00% TA52
R602	0RD0221A609	2.2 OHM 1/2 W(7.0) 5.00% TA52
R603	0RD0221A609	2.2 OHM 1/2 W(7.0) 5.00% TA52
R604	0RD0221A609	2.2 OHM 1/2 W(7.0) 5.00% TA52
R605	0RD1101F609	1.1K OHM 1/6 W 5.00% TA52
R606	0RD5601F609	5.6K OHM 1/6 W 5% TA52
R607	0RD1002F609	10K OHM 1/6 W 5% TA52
R608	0RD1001F609	1K OHM 1/6 W 5% TA52
R609	0RD1000F609	100 OHM 1/6 W 5% TA52
R610	0RD1802F509	18K OHM 1/6 W 2.00% TA52
R611	0RD1101F609	1.1K OHM 1/6 W 5.00% TA52
R612	0RD5601F609	5.6K OHM 1/6 W 5% TA52
R613	0RD0221F609	2.2 OHM 1/6 W 5.00% TA52
R614	0RD1000F609	100 OHM 1/6 W 5% TA52
R615	0RD1001F609	1K OHM 1/6 W 5% TA52
R616	0RD2700F609	270 OHM 1/6 W 5% TA52
R617	0RD6801F609	6.8K OHM 1/6 W 5.00% TA52
R618	0RD6801F609	6.8K OHM 1/6 W 5.00% TA52
R619	0RD6801F609	6.8K OHM 1/6 W 5.00% TA52
R620	0RD1000F609	100 OHM 1/6 W 5% TA52
R621	0RD6801F609	6.8K OHM 1/6 W 5.00% TA52
R624	0RD6801F609	6.8K OHM 1/6 W 5.00% TA52
R664	0RD6801F609	6.8K OHM 1/6 W 5.00% TA52
R802	0RKZVTA001K	0.47M OHM 1/2 W 5% TA52
R803	180-822N	RWR 7W 1.0 OHM J PD
R804	0RS4702K619	47K OHM 2 W 5% TR
R805	0RS4702K619	47K OHM 2 W 5% TR
R806	180-A01N	0.18 OHM 2 W 5% TA62 PRW
R807	0RD2200A609	220 OHM 1/2 W(7.0) 5.00% TA52
R808	0RD1501F609	1.5K OHM 1/6 W 5% TA52
R809	0RD1001F609	1K OHM 1/6 W 5% TA52
R810	0RD0472F609	47 OHM 1/6 W 5% TA52

For Capacitor & Resistors, the characters at 2nd and 3rd digit in the P/No. means as follows;

CC, CX, CK, CN : Ceramic	RD : Carbon Film
CQ : Polyester	RS : Metal Oxide Film
CE : Electrolytic	RN : Metal Film
	RF : Fusible

LOCA. NO	PART NO	DESCRIPTION
R814	0RK8204H609	8.2M OHM 1/2 W 5.00% TA52
R816	0RD1001F609	1K OHM 1/6 W 5% TA52
R817	0RD0152F609	15 OHM 1/6 W 5.00% TA52
R823	0RD4701F609	4.7K OHM 1/6 W 5% TA52
R827	0RD1001F609	1K OHM 1/6 W 5% TA52
R828	0RD1501F609	1.5K OHM 1/6 W 5% TA52
R831	0RD2201F609	2.2K OHM 1/6 W 5.00% TA52
R838	0RD4701F609	4.7K OHM 1/6 W 5% TA52
R858	0RD4701F609	4.7K OHM 1/6 W 5% TA52
R903	0RD2200F609	220 OHM 1/6 W 5.00% TA52
R904	0RD2200F609	220 OHM 1/6 W 5.00% TA52
R905	0RD2200F609	220 OHM 1/6 W 5.00% TA52
R906	0RD1000F609	100 OHM 1/6 W 5% TA52
R907	0RD1000F609	100 OHM 1/6 W 5% TA52
R908	0RD1000F609	100 OHM 1/6 W 5% TA52
R909	0RCZVTA002D	1/2 W 1.5K,10%,PLIKOR(HIGH SURGE)
R910	0RCZVTA002D	1/2 W 1.5K,10%,PLIKOR(HIGH SURGE)
R911	0RCZVTA002D	1/2 W 1.5K,10%,PLIKOR(HIGH SURGE)
R912	0RD2204A609	2.2M OHM 1/2 W(7.0) 5.00% TA52
R914	0RD0102F609	10 OHM 1/6 W 5% TA52
SWITCH		
SW1111	140-313B	TACT 2LEAD 160G(TA) LG C&D
SW1111	6600VM2002A	SDKEA3 ALPS IEC 250V 8A HORIZONTAL 480G
SW1112	140-313B	TACT 2LEAD 160G(TA) LG C&D
SW1113	140-313B	TACT 2LEAD 160G(TA) LG C&D
SW1114	140-313B	TACT 2LEAD 160G(TA) LG C&D
SW1115	140-313B	TACT 2LEAD 160G(TA) LG C&D
SW1116	140-313B	TACT 2LEAD 160G(TA) LG C&D
FILTER & CRYSTAL		
FB801	125-022K	FERRITE AXIAL 62MM 1UH NY 3.5X6.0MM
FB802	125-022K	FERRITE AXIAL 62MM 1UH NY 3.5X6.0MM
FB803	125-022K	FERRITE AXIAL 62MM 1UH NY 3.5X6.0MM
FB825	125-022K	FERRITE AXIAL 62MM 1UH NY 3.5X6.0MM
T802	150-F06W	SQE2930 36MH 0.5PHY 105TURN .
X11	6202VDB007B	RESONATOR,CRYSTAL HC49U 20.250MHZ
Z101	6200QL3001Z	B39361-X6966-D100 EPCOS ST
JACK		
JK202	6612VJH023D	PPJ 126-04 PIN JACK
PJ1202	6613V00004F	PPJ107F PA/V 3P DOUBLE S/W
PJ1203	380-068D	UEJ-CV-003 E/P WITH S/W STEREO(068B) D3.5
ACCESSORIES		
A1	3828VA0474A	MANUAL,OWNERS EN 090A/D TX
A2	6710V00124D	REMOTE CONTROLLER, MC049B W/O TXT
MISCELLANEOUS		
F1111	0FS4001B53C	FUSE,SLOW BLOW 4000MA 250 V 5.2X20
PA1101	6726VV0006D	REMOTE CONTROLLER RECEIVER, TSOP4838ON1
SK901	6620VBC003A	SOCKET (CIRC),CPT PCS030A 8PIN

LOCA. NO	PART NO	DESCRIPTION
T402	6174V-6006M	FBT, BSC25-N1648 21 YY .
TH801	163-051F	THERMISTOR,PTC J503P84D140M290Q
TU101	6700MF0011A	TUNER, TEAM-G601D W/S LNA 38.9MHZ
VD1111	164-003G	VARISTOR, TVR621D14A THINKING 620V 10%

MC-049B CIRCUIT DIAGRAM 040531

SIDE A/V BOARD

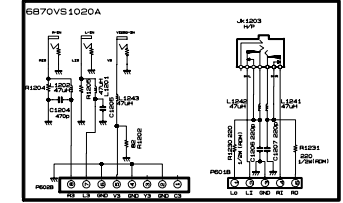

NOTICE

NOTE: THIS IS BEST COPY AVAILABLE. THE VALUE OF COMPONENTS AND SOME SPECIAL CONNECTIONS ARE SUBJECT TO CHANGE FOR IMPROVEMENT WITHOUT NOTICE.

The components marked with a triangle are essential for safe operation of the TV receiver. While these symbols are required for correct operation, the manufacturer's parts only when replacing.

Value of resistor, capacitor and inductor

1. Resistances are shown in ohms, kilohms, megohms, etc.
2. Values are shown in standard notation. All resistor values less than 1 are expressed in ohms and the values more than 1 in k.
3. Values are shown in standard notation. All capacitor values more than 1 are expressed in microfarads and the values less than 1 in p (pico).

Observation of voltages and waveforms

1. Voltages are given in Vrms from point to ground unless otherwise noted.
2. The schematic shows the approximate waveforms.
3. All waveforms are taken using a 100 ohm impedance probe.
4. Check FREQ. TAPING AND CONTROLS. BRIGHTNESS AND COLOR CONTROLS FOR BEST DISPLAY. MAKE SURE THE COLOR AND BRIGHTNESS ARE IN HIGH POSITION AND CONTRAST IS IN THE MIDDLE POSITION.
5. Waveforms are taken using a standard color signal.

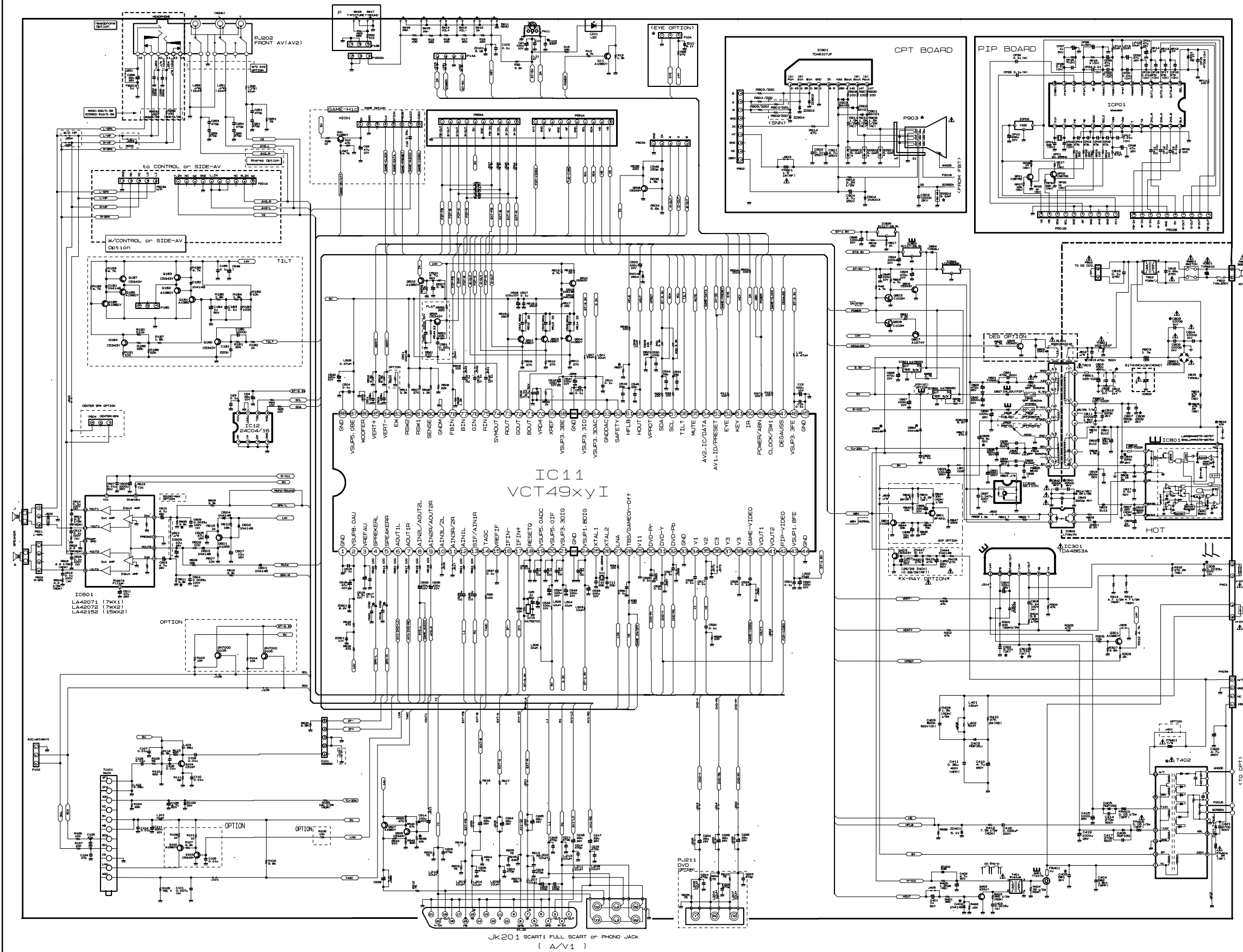

SVC. SHEET : 3854VA0162A-S



P/NO : 3828VD0196V

Sep.,2004
Printed in Korea