

10 Schematic Diagrams

10-1 Main Part Schematic Diagram

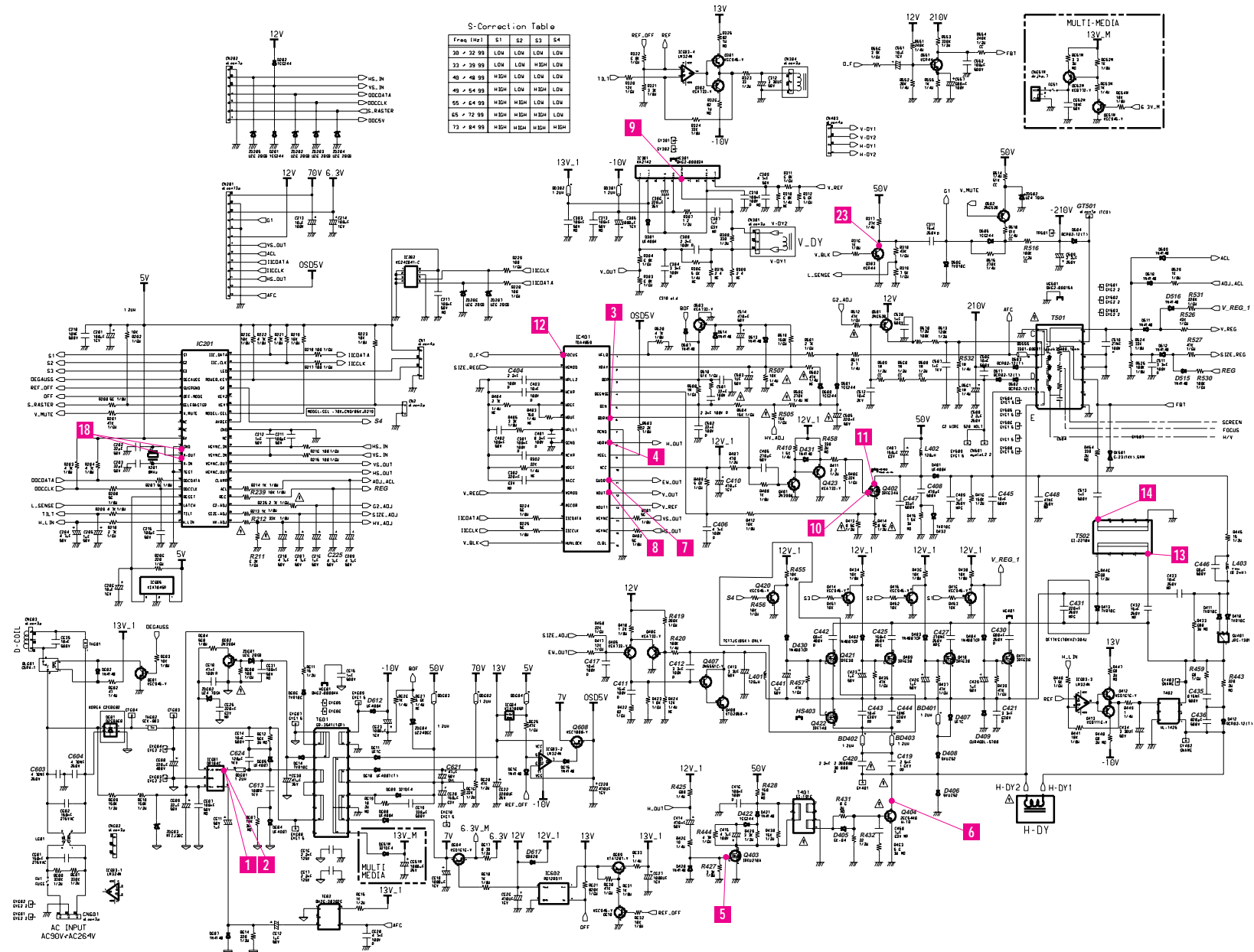

S-Connection Table

Freq (Hz)	S1	S2	S3	S4
30 ~ 32.99	LOW	LOW	LOW	LOW
33 ~ 35.99	LOW	LOW	HIGH	LOW
40 ~ 48.99	HIGH	LOW	LOW	LOW
49 ~ 54.99	HIGH	LOW	HIGH	LOW
55 ~ 64.99	HIGH	HIGH	LOW	LOW
65 ~ 72.99	HIGH	HIGH	HIGH	LOW
73 ~ 84.99	HIGH	HIGH	HIGH	HIGH

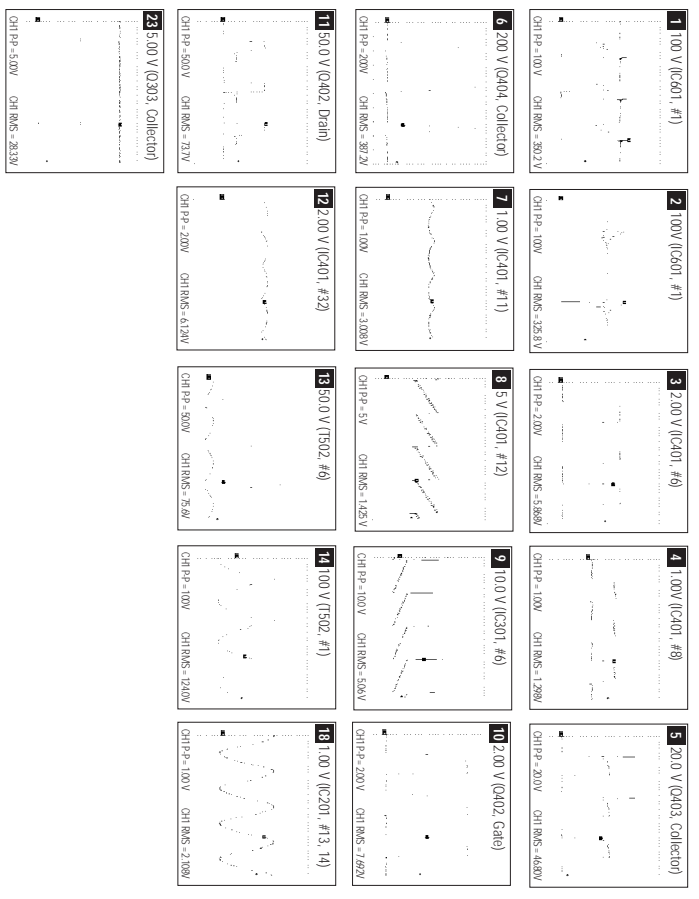

10-2 Video Part Schematic Diagram

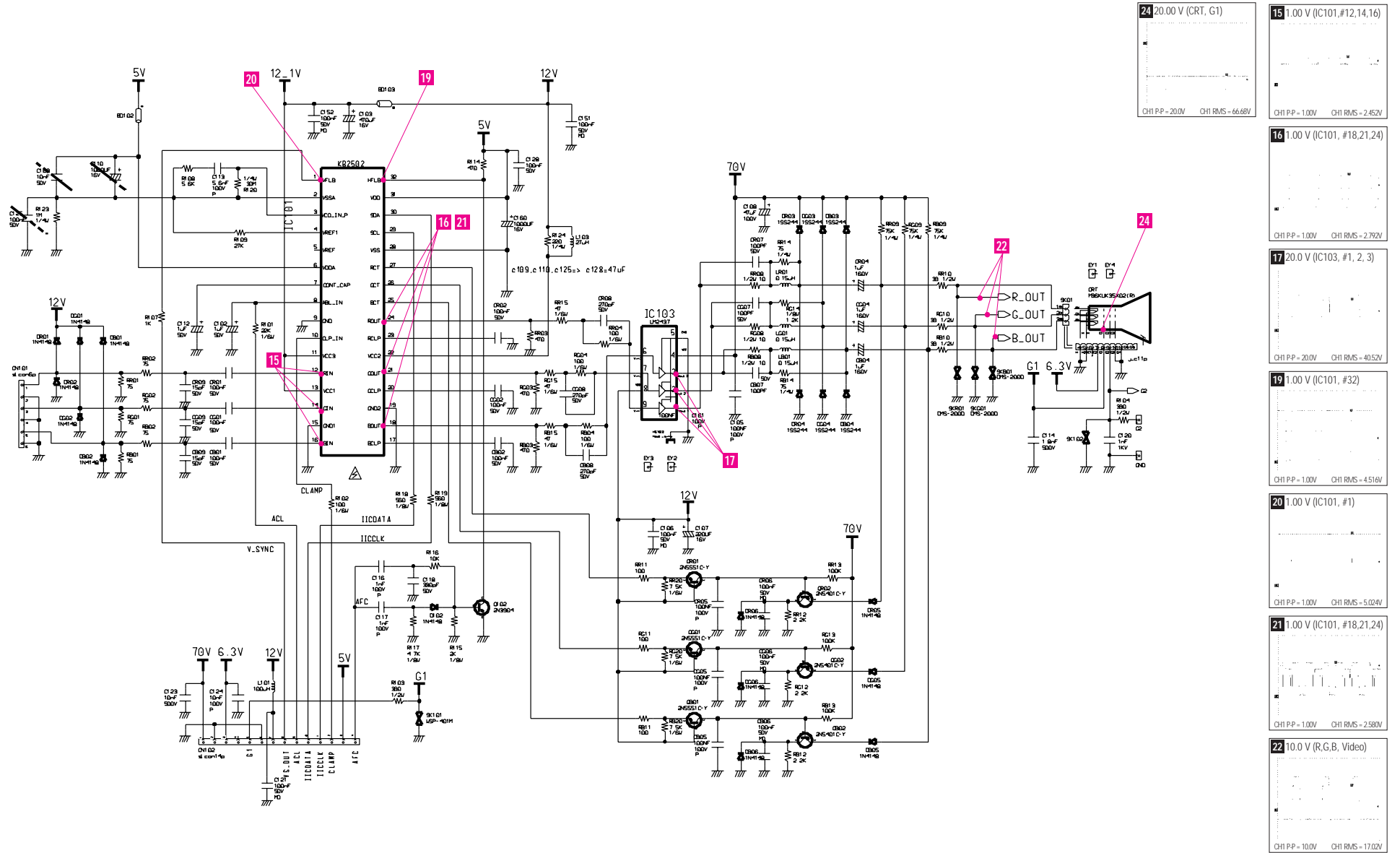

Memo