

The Harman Kardon Model hk870 STEREO POWER AMPLIFIER

Manual No. 65A

Technical Manual

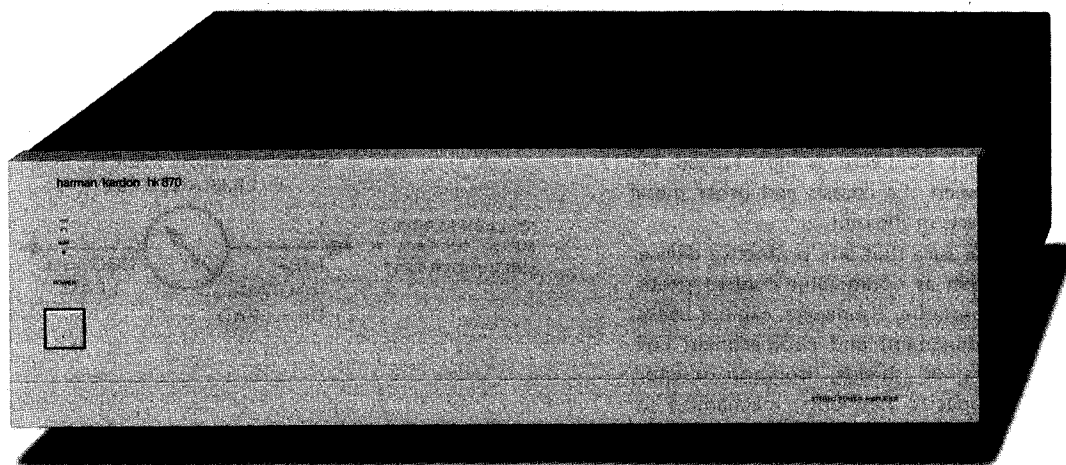

harman/kardon

240 CROSSWAYS PARK WEST, WOODBURY, N.Y. 11797
1112-H15265A0 P-08836 1250 PRINTED IN JAPAN

hk870

SPECIFICATIONS

	Nominal	Limit
Input Sensitivity	1.0V	± 0.2V
Input Impedance at 1kHz	22kΩ	± 2kΩ
Frequency Response	0.1Hz ~ 170kHz	≥ 150kHz
Signal to Noise Ratio	98dB	≥ 90dB
Channel Separation at 10kHz	73dB	≥ 70dB
Total Harmonic Distortion		
20Hz	0.017%	≤ 0.03%
1kHz	0.016%	≤ 0.03%
20kHz	0.021%	≤ 0.035%
RMS Output Power		
8Ω, 20Hz ~ 20kHz, THD 0.06%	110W	≥ 100W
4Ω, 1kHz, THD 0.06%	160W	≥ 150W
Power Bandwidth (1/2 rated power)	20Hz ~ 80kHz	≥ 70kHz
IM Distortion Ratio at 1W	0.05%	≤ 0.07%
Damping Factor at 1kHz	125	≥ 100

	Nominal	Limit
Slew Rate	160V/μs	≥ 130V/μs
DC Balance	0mV	± 50mV
Idle Current	75mA	± 5mA
Current Capability	60A	≥ 53A
Dimensions (W x H x D)	443 x 135 x 386	mm
Weight	12.3	kg
Power Supply	AC 120V, 60Hz	
Power Consumption	550W	

This specification is the target of servicing. But, there is a case that the specification is not applicable to the measurement condition and instrument.

Specifications and components subject to change without notice. Overall performance will be maintained or improved.

LEAKAGE TEST

Before returning the unit to the user, perform the following safety checks:

1. Inspect all lead dress to make certain that leads are not pinched or that hardware is not lodged between the chassis and other metal parts in the unit.
2. Be sure that any protective devices such as nonmetallic control knobs, insulating fishpapers, cabinet backs, adjustment and compartment covers or shields, isolation resistor-capacity networks, mechanical insulators, etc. which were removed for servicing are properly reinstalled.
3. Be sure that no shock hazard exists; check for leakage current using Simpson Model 229 Leakage Tester, standard equipment item No. 21641, RCA Model WT540A or use alternate method as follows:

Plug the AC line cord directly into a 120-volt AC receptacle (do not use an Isolation Transformer for this test). Using two clip leads, connect a 1500 ohm, 10-watt resistor paralleled by a 0.15mf capacitor, in series with all exposed metal cabinet parts and a known earth ground, such as a water pipe or conduit. Use a VTVM or VOM with 1000 ohms per volt, or higher, sensitivity to measure the AC voltage drop across the resistor. (See Diagram.) Move the resistor connection to each exposed metal part having a return path to the chassis (antenna, metal, cabinet, screw heads, knobs and control shafts, escutcheon, etc.) and measure the AC voltage drop across the resistor. (This test should be performed with the power switch in both the On and Off positions.)

A reading of 0.35 volt RMS or more is excessive and indicates a potential shock hazard which must be corrected before returning the unit to the owner.

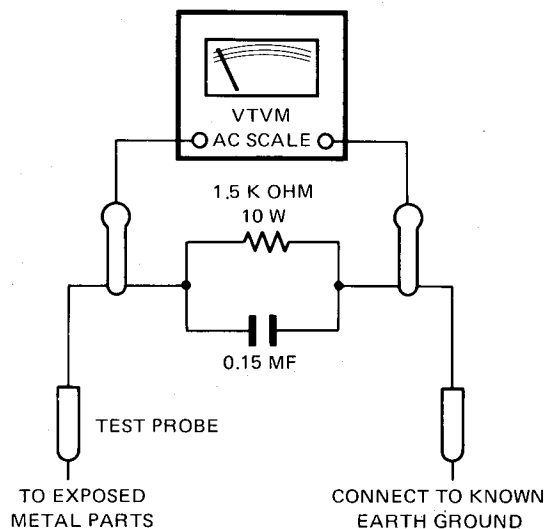
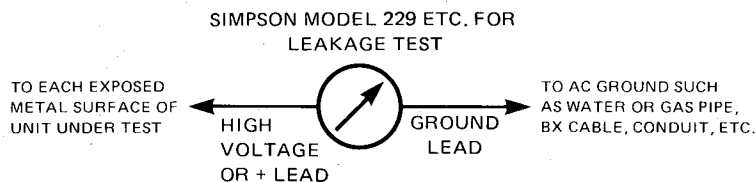

DISASSEMBLY PROCEDURES (REFER TO PAGES 4 AND 10)

Note: When replacing parts, discharge by shorting between terminals of the capacitor (C7, 8, 9, 10, 28, 29, 30, 31) at the power source with 8Ω 100W resistor as it may have charge accumulated.

1 CABINET TOP REMOVAL

Remove 10 screws (A) and remove the cabinet top.

2 FRONT PANEL ASSEMBLY (101) REMOVAL

1. Remove the cabinet top. (Refer to step 1.)
2. Remove 6 screws (B) and remove the front panel assembly.

3 POWER AMP. DRIVER P.C. BOARD (PCB-2) REMOVAL

1. Remove the cabinet top. (Refer to step 1.)
2. Remove 2 screws (C) and remove the power amp. driver P.C. board (PCB-2) with heat sink (196) upward. If necessary, unsolder the leads.

4 POWER SUPPLY P.C. BOARD (PCB-4) REMOVAL

1. Remove the power amp. driver P.C. board (PCB-2). (Refer to step 3.)
2. Remove 3 screws (D) and remove the power supply P.C. board (PCB-4). If necessary, unsolder the leads.

5 MAIN P.C. BOARD (PCB-1) REMOVAL

1. Remove the power amp. driver P.C. board (PCB-2). (Refer to step 3.)
2. Remove 2 screws (E) and remove the input jack P.C. board (PCB-7).
3. Remove 12 screws (F) and remove the main P.C. board (PCB-1). If necessary, unsolder the leads.

ALIGNMENT PROCEDURES

- Conditions:**
- After the power switch is pushed on, wait for 20 minutes before measuring to be sure of the most stable operation.
 - Make the adjustment at a room temperature of 25°C.

Step	Adjustment item	Connection required	Adjustment location	Adjustment value
1	DC Balance	Connect the DC voltmeter to left channel speaker terminal.	VR401	0V ± 10mV
2		Connect the DC voltmeter to right channel speaker terminal.	VR402	
3	Idling current	Connect the DC voltmeter to TP1 (+) and TP2 (-).	VR403	50mV (75mA)
4		Connect the DC voltmeter to TP4 (+) and TP3 (-).	VR404	
5	Idling current confirmation	Connect the DC voltmeter to TP5 (+) and TP6 (-).		50mV ± 5mV
6		Connect the DC voltmeter to TP8 (+) and TP7 (-).		

CIRCUIT DESCRIPTION

• Over load protection Lch (Rch)

As soon as the current over rated power flows, the voltage between TP1 (TP4) and TP2 (TP3) rises and Q445 (Q446), Q447 (Q448) and Q10 are turned on. So Q5 (Schmit trigger circuit) is turned off and Q7 is turned on, Q413 (Q414) is turned off and Q41.1 (Q412) is turned off. The operation of power amp. circuit stops and the circuit is protected.

A B C D E
GENERAL UNIT EXPLODED VIEW

1
2
3
4
5
6
7

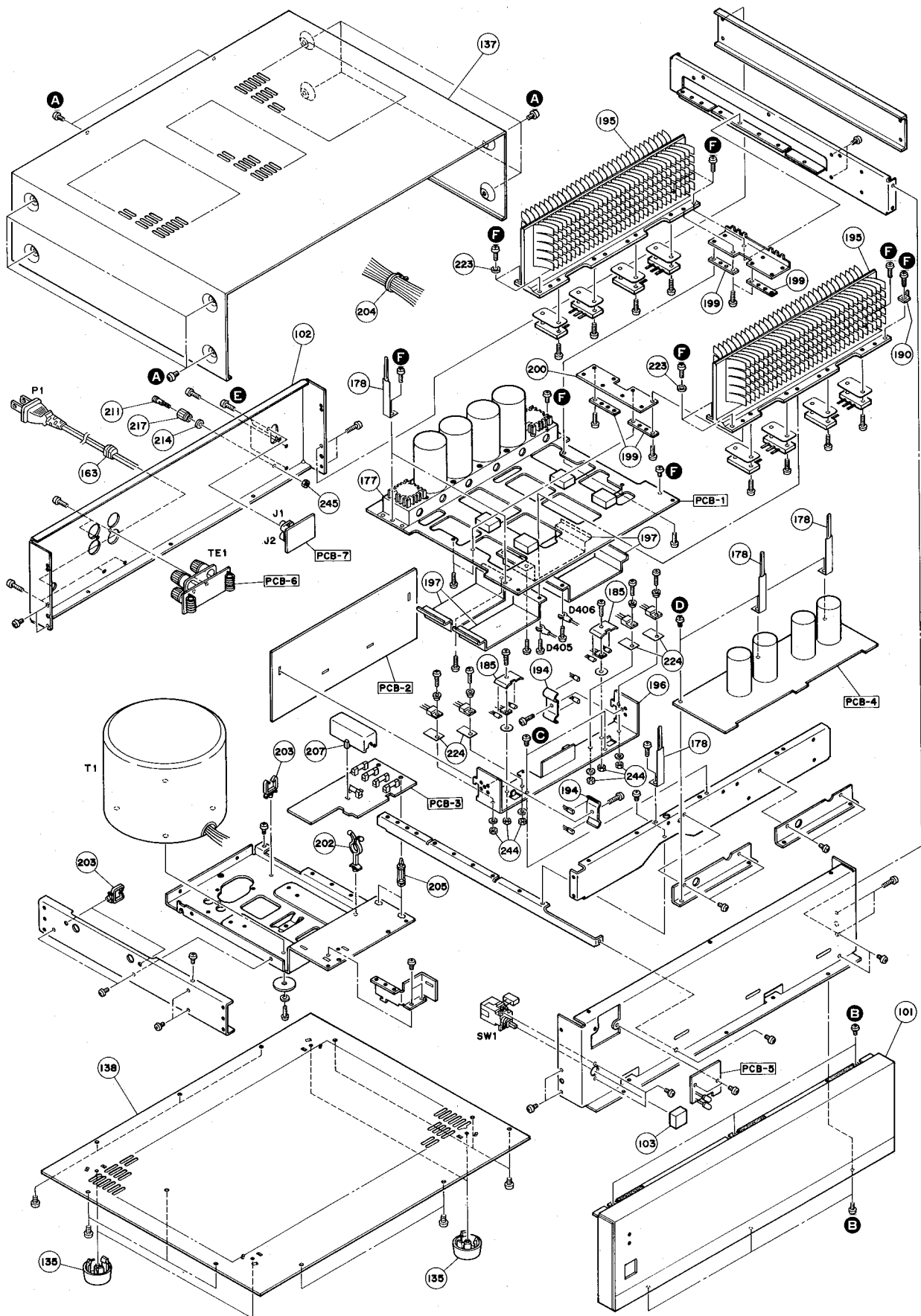

GENERAL UNIT PARTS LIST

Ref. No.	Part No.	Description
101	A443-HK870A	Front Panel Assembly
102	A424-HK870A	Cabinet Back Assembly
"	A424-HK870D	Cabinet Back Assembly (for Canada model)
103	A660-HK870A	Push Button Assembly, Power
135	1319-0139	Foot
137	1414-04201	Cabinet Top
138	1423-01202	Cabinet Bottom
163	2114-415027	Bushing
177	2216-7116	Shield Plate
178	2218-7011	Holding Bracket
185	2219-7795	Bracket
190	2219-7945	Earth Bracket
194	2222-7066	Heat Sink
195	2222-7122	Heat Sink, Main
196	2222-7123	Heat Sink
197	2222-7137	Heat Sink
199	2224-7069	Insulator
200	2224-7084	Insulator
202	2240-7050	Holder
203	2240-7061	Holder
204	2240-7120	Holder
205	2240-7151	Holder
207	2240-7176	Holder
211	2310-7015	Special Screw
214	2410-7005	Special Washer
217	2440-7011	Special Nut
223	2114-71259	Bushing
224	2224-7071	Insulator
244	2446-301Z9	Hexagon Nut
245	2440-7016	Special Nut
	2211-7246	Chassis, Front
	2219-7827	Bracket, T1
	2219-7947	Bracket, Left & Right
	2219-7949	Bracket, PCB-1 Left Mounting
	2219-7948	Bracket, Center
	2219-7804	Bracket, Main Heat Sink
	2219-7938	Bracket, PCB-3 Mounting
	2219-7939	Bracket, PCB-4 Mounting
	2219-7940	Bracket, PCB-1 Right Mounting
	1111-J30139	Owner Guide
	1111-J30140	Owner Guide (for Canada model)
	1221-757143	Packing Box
	1222-7225	Packing Cushion, Right
	1222-7226	Packing Cushion, Left

ELECTRICAL PARTS LIST

Ref. No.	Part No.	Description
CHASSIS MISCELLANEOUS		
P1	4161-71151	Power Cord
T1	5584-701440	Power Transformer
CO1	4443-712	Connector, Power Cord
SW1	4431-01017358	Push Switch, Power
C1	5352-1030959	Capacitor, 0.01 μ F, \pm 20%, AC125V, Metalized Polyester
PCB-1 MAIN P.C. BOARD		
RESISTORS		
R11	5102-2R2579	2.2 Ω , \pm 5%, 1/4W, Fuse
R27	5102-2214713	220 Ω , \pm 2%, 1/4W, Fuse
R313/315, 314/316, 319/321, 320/322	5275-R33671	0.33 Ω , \pm 10%, 5Wx2, Cement
R317, 318	5175-220571	22 Ω , \pm 5%, 3W, Metal
CAPACITORS		
C3, 4, 5, 6	5352-1041957	0.1 μ F, \pm 10%, 250V, Metalized Polyester
C7, 8, 9, 10	5341-109G0281	10000 μ F, \pm 20%, 63V, Electrolytic
C21, 22	5345-476C0951	47 μ F, \pm 20%, 16V, Electrolytic
C23	5345-105F0951	1 μ F, \pm 20%, 50V, Electrolytic
TRANSISTORS		
Q5, 7, 8, 10, 413, 414	5611-1115(E)	2SA1115(E) or 2SA1115(F)
Q6, 9	5613-2603(E)	2SC2603(E) or 2SC2603(F)
Q437, 438, 439, 440	5614-845(O)	2SD845(O) or 2SD845(R) (w/Insulator)
Q441, 442, 443, 444	5612-755(O)	2SB755(O) or 2SB755(R) (w/Insulator)
Q445, 446	5611-872(E)	2SA872(E)
Q447, 448	5613-1775(F)	2SC1775(F)
DIODES		
D1, 2	5685-D5FB20	Bridge Silicon, D5FB20
D3	5636-1S2471	1S2471
D8	5635-RD13EB3	Zener, RD13EB3
D9	5636-1S2472	1S2472
D405, 406	5641-MV12YM	Varister, MV12YM
D407, 408, 409, 410	5632-10DF2	10DF2
COILS		
L401, 402, 403, 404	5597-45502	Ferrite Bead
MISCELLANEOUS		
J401, 402	4443-107149	Connector, 10 Pos.
	2132-5049	Spacer, R313/315, 314/316, 319/321, 320/322
	2132-7049	Spacer, R317, 318
PCB-2 POWER AMP. DRIVER P.C. BOARD		
RESISTORS		
R301, 302, 303, 304, 417, 418, 419, 420	5174-182381	1.8k Ω , \pm 1%, 1/4W, Metal
R305, 306, 497, 498	5102-1504713	15 Ω , \pm 2%, 1/4W, Fuse
R307, 308	5174-243381	24k Ω , \pm 1%, 1/4W, Metal
R345, 346, 347, 348	5102-8204713	82 Ω , \pm 2%, 1/4W, Fuse
R401, 402	5174-223381	22k Ω , \pm 1%, 1/4W, Metal
R403, 404	5174-102381	1k Ω , \pm 1%, 1/4W, Metal
R415, 416	5102-1204713	12 Ω , \pm 2%, 1/4W, Fuse
R451, 452	5174-681381	680 Ω , \pm 1%, 1/4W, Metal
R453, 454	5174-330381	33 Ω , \pm 1%, 1/4W, Metal
R455, 456, 463, 464	5102-1224713	1.2k Ω , \pm 2%, 1/4W, Fuse
R467, 468, 469, 470, 471, 472, 473, 474, 475, 476, 477, 478	5174-562381	5.6k Ω , \pm 1%, 1/4W, Metal
R487, 488, 491, 492	5102-1014713	100 Ω , \pm 2%, 1/4W, Fuse
R489, 490, 493, 494	5102-2R2579	2.2 Ω , \pm 5%, 1/4W, Fuse
R495, 496	5102-5605114	56 Ω , \pm 5%, 1/2W, Fuse

Ref. No.	Part No.	Description
	CONTROLS	
VR401, 402	5101-4728175	4.7k Ω , DC Balance Adjustment
VR403, 404	5101-1027875	1k Ω , Idling Current Adjustment
	CAPACITORS	
C401, 402	5359-8215851	820pF, \pm 5%, 100V, Polypropylene
C403, 404, 405, 406	5345-106F0951	10 μ F, \pm 20%, 50V, Electrolytic
C407, 408, 411, 412	5352-1041960	0.1 μ F, \pm 10%, 100V, Metalized Polyester
C409, 410	5353-020934	2pF, \pm 0.5pF, 500V, Mica
C413, 414	5352-1051960	1 μ F, \pm 10%, 100V, Metalized Polyester
C427, 428	5359-1015851	100pF, \pm 5%, 100V, Polypropylene
C431, 432, 433, 434	5345-106J0226	10 μ F, \pm 20%, 100V, Electrolytic
	TRANSISTORS	
Q401, 402	5616-2SK270BL	F.E.T., 2SK270(BL) or 2SK270(V)
Q403, 404, 405, 406, 411, 412	5613-1845(E)	2SC1845(E)
Q417, 418, 421, 422	5613-2320L(F)	2SC2320L(F)
Q419, 420	5611-992(E)	2SA992(E)
Q423, 424	5611-999L(F)	2SA999L(F)
Q425, 426	5611-1145(Y)	2SA1145(Y)
Q427, 428	5613-2705(Y)	2SC2705(Y)
Q429, 430	5613-2235(Y)	2SC2235(Y)
Q431, 432	5611-965(Y)	2SA965(Y)
Q433, 434	5611-968(O)	2SA968(O) (w/Bushing)
Q435, 436	5613-2238(O)	2SC2238(O) (w/Bushing)
Q449, 450	5614-415(Q)	2SD415(Q) (w/Insulator)
	DIODES	
D401, 402, 403, 404	5635-HZ15-2L	Zener, HZ15-2L
D411, 412	5641-MV5W	Varistor, MV5W
	MISCELLANEOUS	
P401, 402	4443-10418	Connector, 10 Pos.
	2132-7048	Spacer, R469, 470, 475, 476

PCB-3 FUSE HOLDER P.C. BOARD

F1	5732-622028	Fuse, 6.25A, 250V
F2, 3, 4, 5	5732-502028	Fuse, 5A, 125V
	4472-7113	Fuse Holder (x 10)

PCB-4 POWER SUPPLY P.C. BOARD

	RESISTORS	
R5, 6, 7, 8	5102-2205711	22 Ω , \pm 5%, 1W, Fuse
R16, 17, 18, 19, 24	5102-2R2579	2.2 Ω , \pm 5%, 1/4W, Fuse
	CAPACITORS	
C12	5345-476E0226	47 μ F, \pm 20%, 35V, Electrolytic
C16	5345-107G045	100 μ F, \pm 20%, 63V, Electrolytic
C28, 29, 30, 31	5341-478G0953	4700 μ F, +30% -10%, 63V, Electrolytic
	TRANSISTORS	
Q4	5612-649(C)	2SB649(C)
	DIODES	
D7	5635-HZ24-2L	Zener, HZ24-2L
D18	5631-1S2473	1S2473

Ref. No.	Part No.	Description
PCB-5 INDICATORS P.C. BOARD		
R51	RESISTOR 5102-1224713	1.2k Ω , \pm 2%, 1/4W, Fuse
C13, 14	CAPACITORS 5345-106C0951	10 μ F, \pm 20%, 16V, Electrolytic
D19 D20	DIODES 5637-GL5HD10 5637-GL5HY10	L.E.D., GL5HD10, Red, On L.E.D., GL5HY10, Amber, Wait
PCB-6 SPEAKER TERMINAL P.C. BOARD		
R341, 342	RESISTORS 5173-100571	10 Ω , \pm 5%, 2W, Metal
L405, 406	COILS 5991-7175	
TE1	MISCELLANEOUS 4214-140	Speaker Terminal
PCB-7 INPUT JACK P.C. BOARD		
C503, 504, 505, 506	CAPACITORS 5345-227B0226	220 μ F, \pm 20%, 10V, Electrolytic
J1/2	MISCELLANEOUS 4482-7126	2-Pin Jack, Line Input

SCHEMATIC DIAGRAM

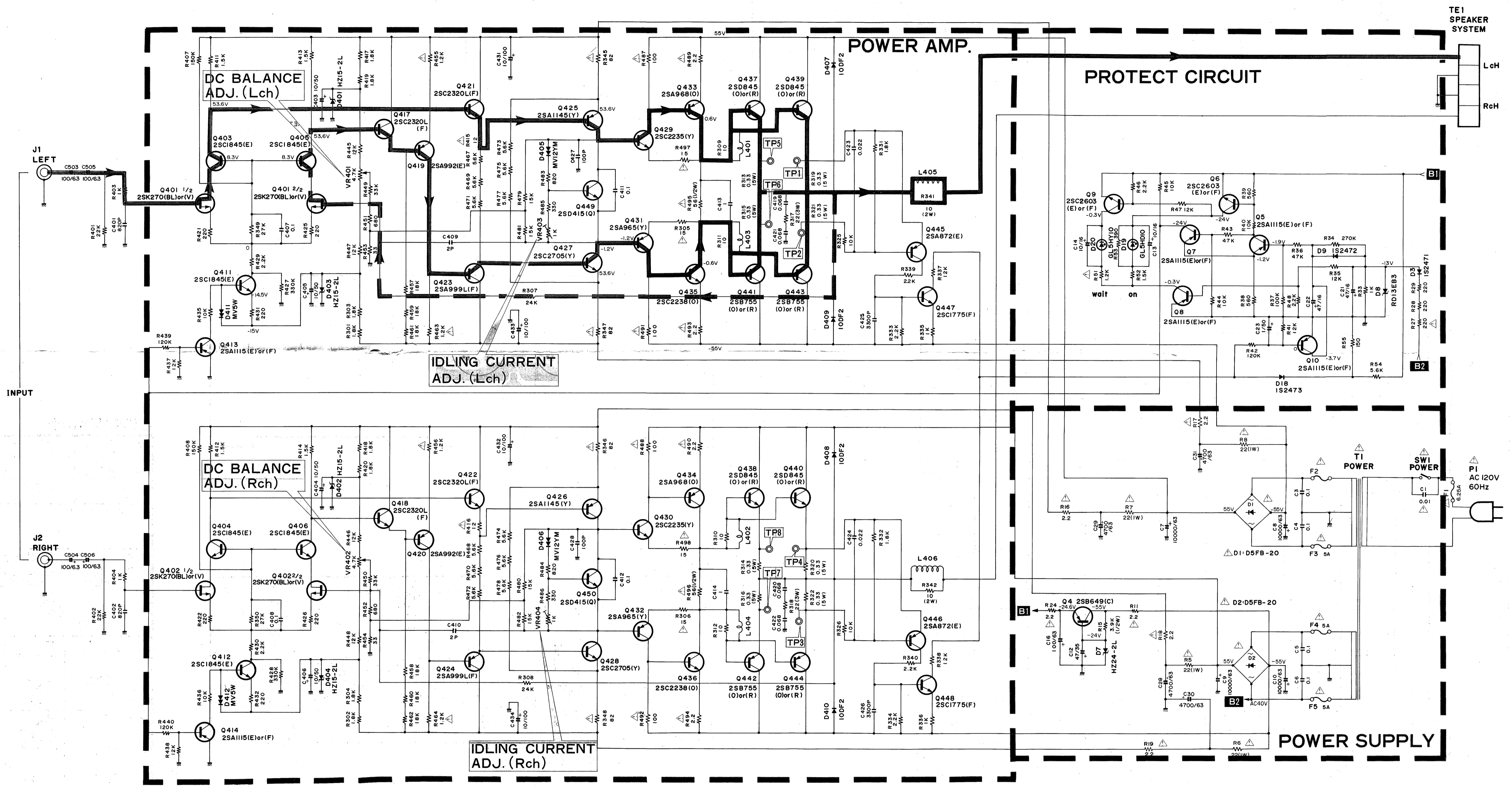

- SIGNAL PATH
 - - - - - NFB SIGNAL
- ALL RESISTANCES VALUES ARE IN Ω.
kΩ = 1000Ω, MΩ = 1000kΩ.
 - THE WATTAGE OF RESISTORS IS 1/4W UNLESS OTHERWISE NOTED.
 - ALL CAPACITANCES VALUES ARE IN μF UNLESS OTHERWISE NOTED. P = μF
AND ALL ELECTRICAL CAPACITANCES VOLTAGE VALUES ARE GIVEN WITHOUT UNIT.
THE OMITTED UNIT IS V. 47/50 → 47μF/50V
 - V: DC VOLTAGE EXCEPT (AC).
...V: AT NO SIGNAL
 - SAFETY-REQUIREMENTS COMPONENTS IN ACCORDANCE WITH PRESENT SAFETY REGULATIONS. THESE COMPONENTS MUST ONLY BE REPLACED BY ORIGINAL PARTS.

SCHEMATIC DIAGRAM

**J1
LEFT**

INPUT

**DC BALANCE
ADJ. (Lch)**

**DC BALANCE
ADJ. (Rch)**

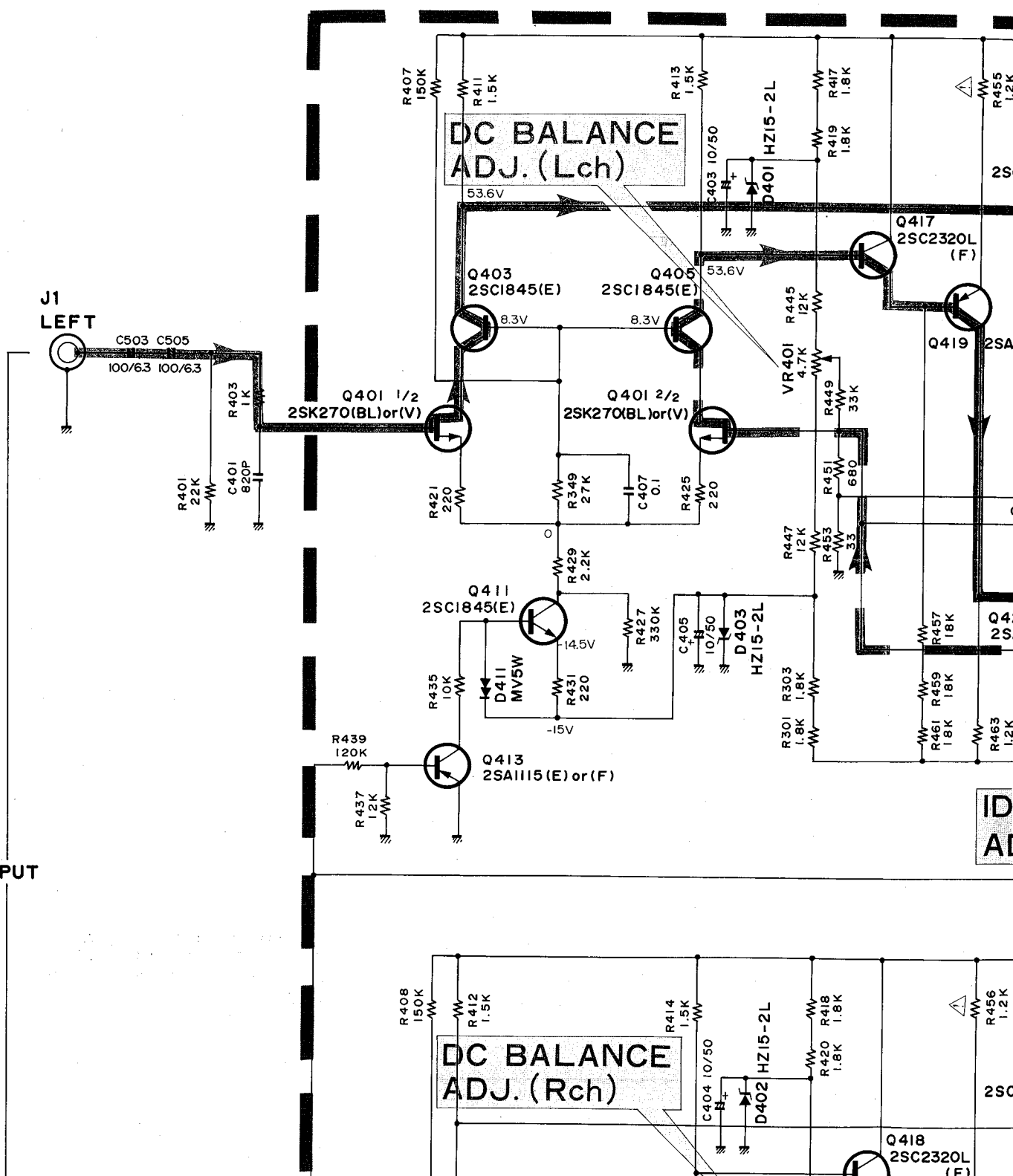

E

F

G

H

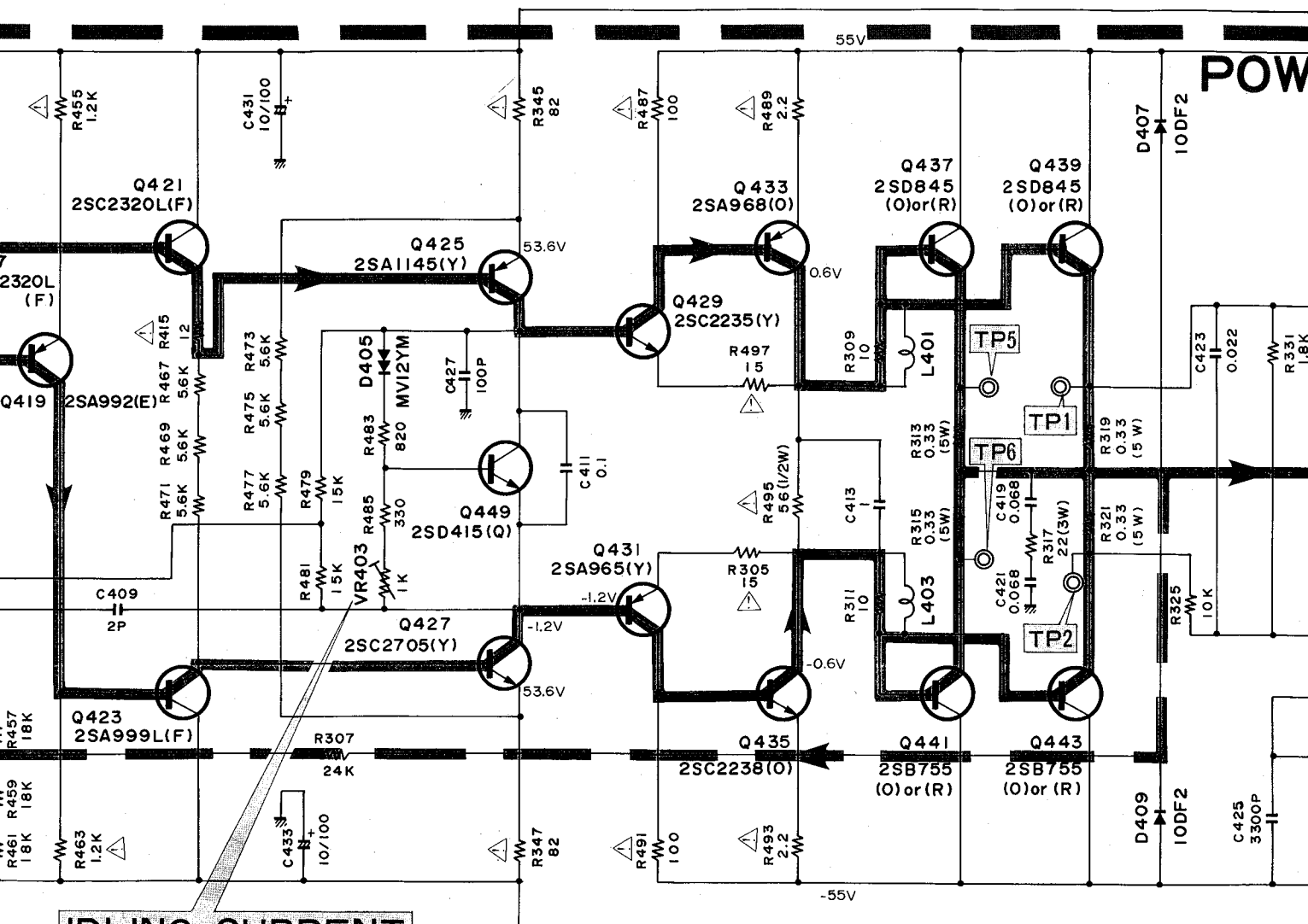

**IDLING CURRENT
ADJ. (Lch)**

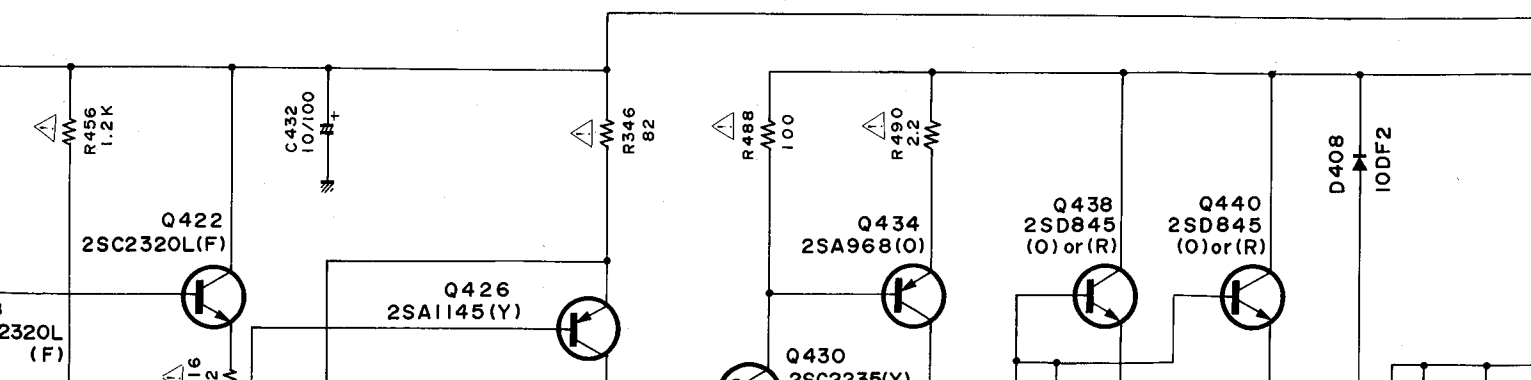

I

J

K

L

POWER AMP.

PROTECT CIRCUIT

10DF2

10DF2

10DF2

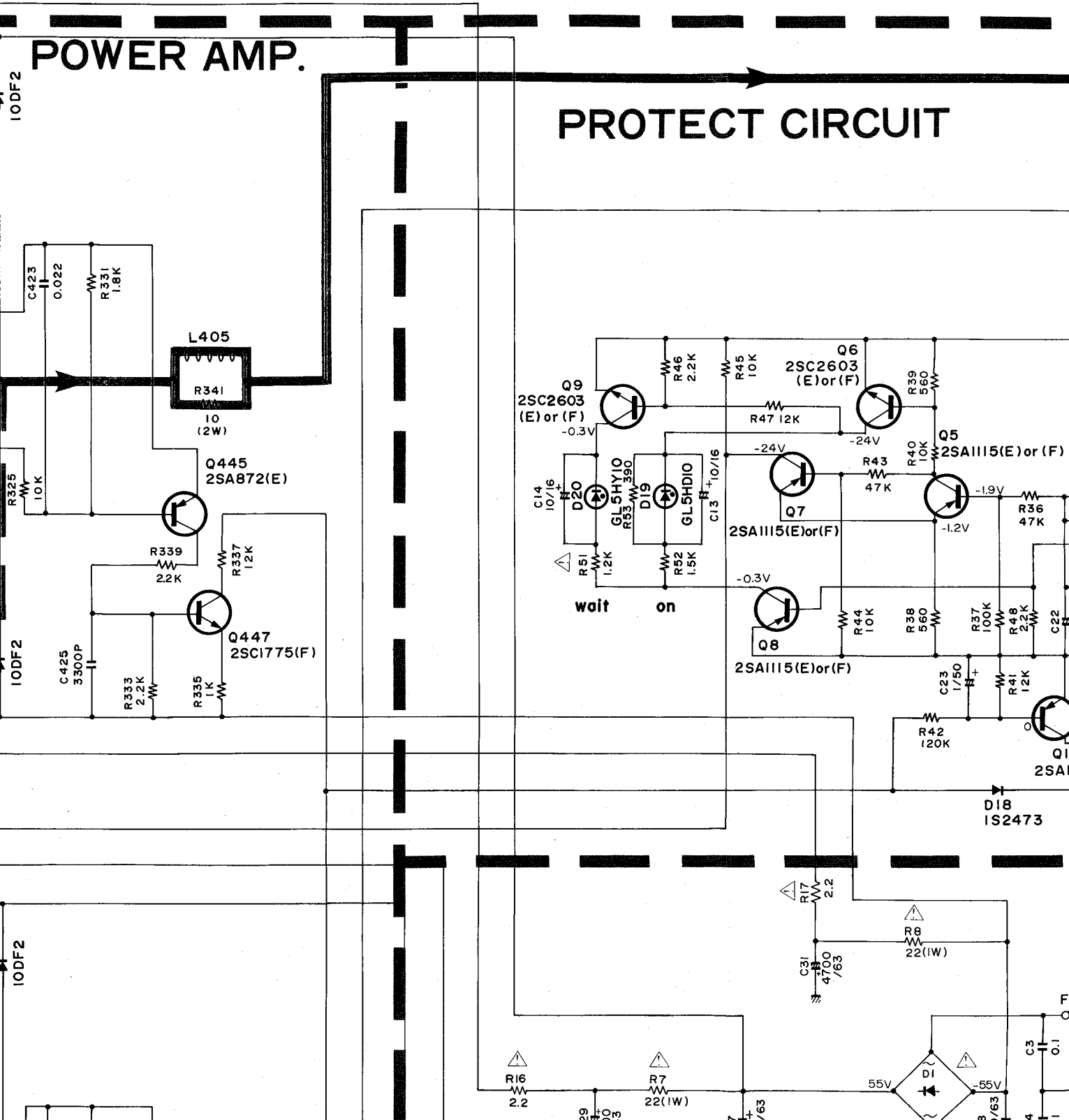

L405

R341
10
(2W)

Q445
2SA872(E)

R339
2.2K

Q447
2SC1775(F)

R333
2.2K

R335
1K

R337
1.2K

Q9
2SC2603
(E) or (F)

D20
GL5HY10

D19
GL5HD10

wait on

Q8
2SA1115(E) or (F)

Q7
2SA1115(E) or (F)

Q6
2SC2603
(E) or (F)

Q5
2SA1115(E) or (F)

Q1
2SA1115(E) or (F)

D18
1S2473

R16
2.2

R7
22(1W)

R17
2.2

R8
22(1W)

C31
4700
/63

55V

-55V

C3
0.1

F

K

L

M

N

PROTECT CIRCUIT

TE1
SPEAKER
SYSTEM

LcH

RcH

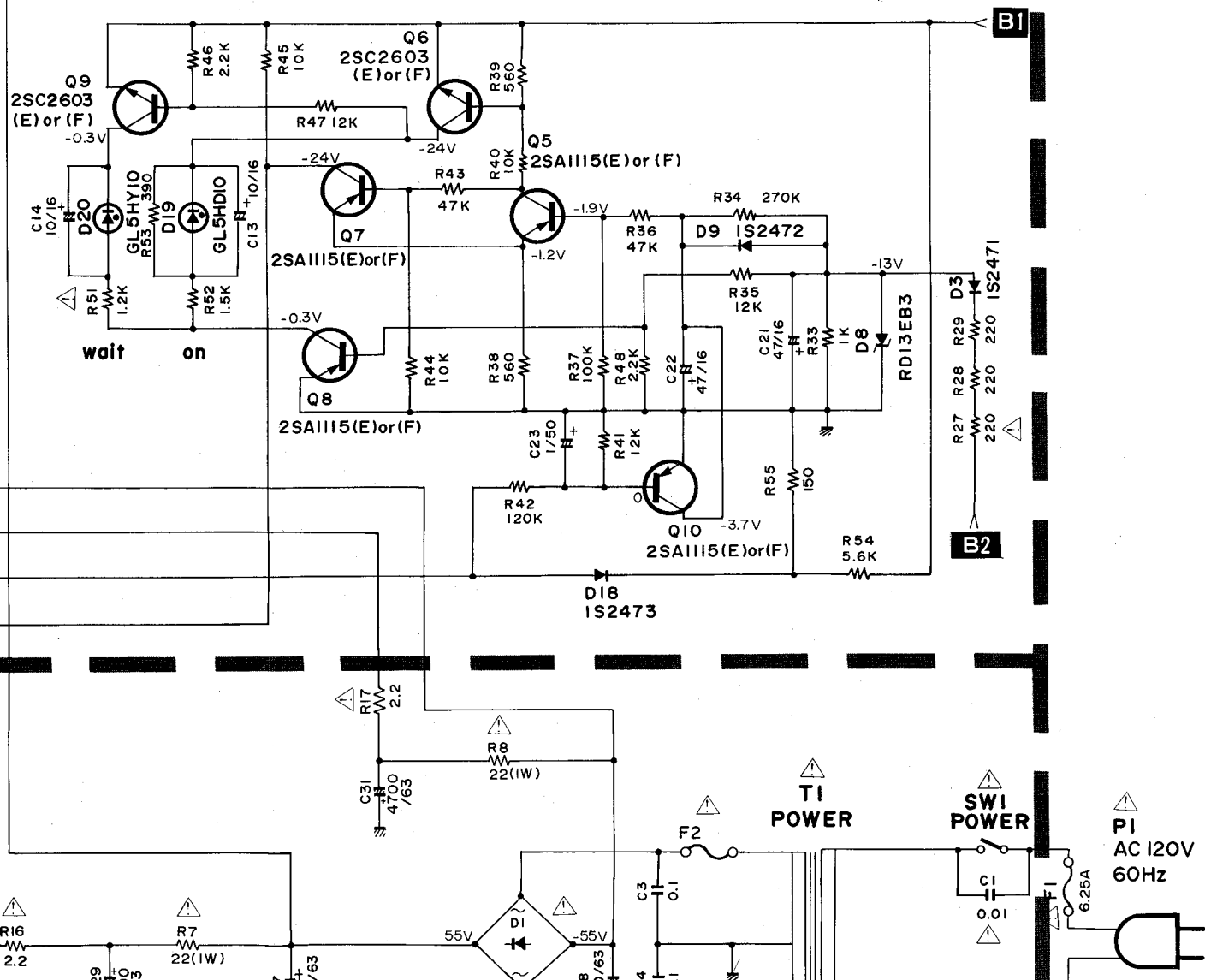

5
6
7
8
9
10

INPUT

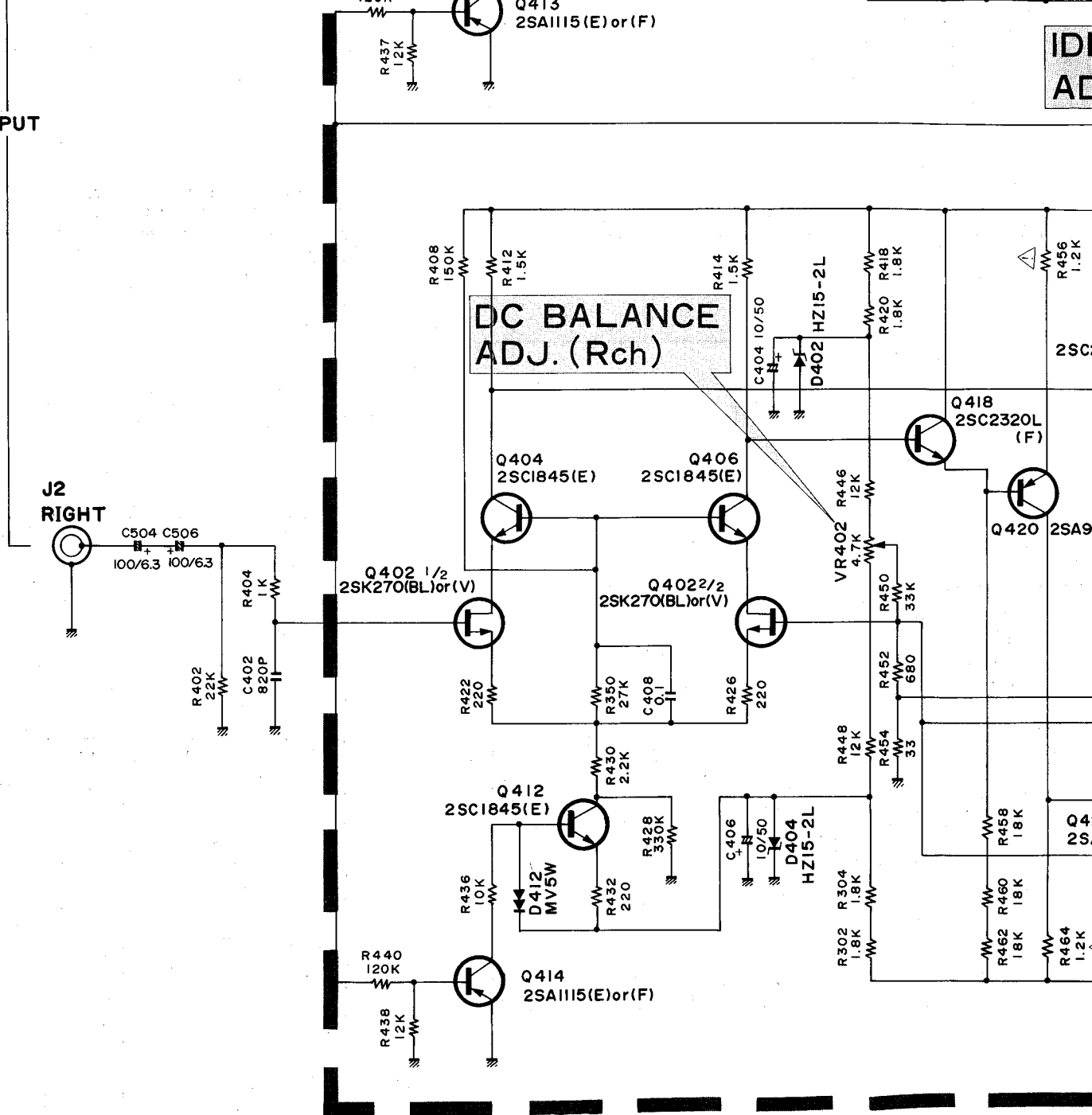

SIGNAL PATH
 NFB SIGNAL

1. ALL RESISTANCES VALUES ARE IN Ω .
 $k\Omega = 1000\Omega$, $M\Omega = 1000k\Omega$
2. THE WATTAGE OF RESISTORS IS 1/4W UNLESS OTHERWISE NOTED.
3. ALL CAPACITANCES VALUES ARE IN μF UNLESS OTHERWISE NOTED. $P = \mu\mu F$
 AND ALL ELECTRICAL CAPACITANCES VOLTAGE VALUES ARE GIVEN WITHOUT UNIT.
 THE OMITTED UNIT IS V. $47/50 \rightarrow 47\mu F/50V$
4. V: DC VOLTAGE EXCEPT (AC).
 $\dots V$: AT NO SIGNAL
5. \triangle SAFETY-REQUIREMENTS COMPONENTS IN ACCORDANCE WITH PRESENT SAFETY REGULATIONS. THESE COMPONENTS MUST ONLY BE REPLACED BY ORIGINAL PARTS.

IDLING CURRENT ADJ. (Lch)

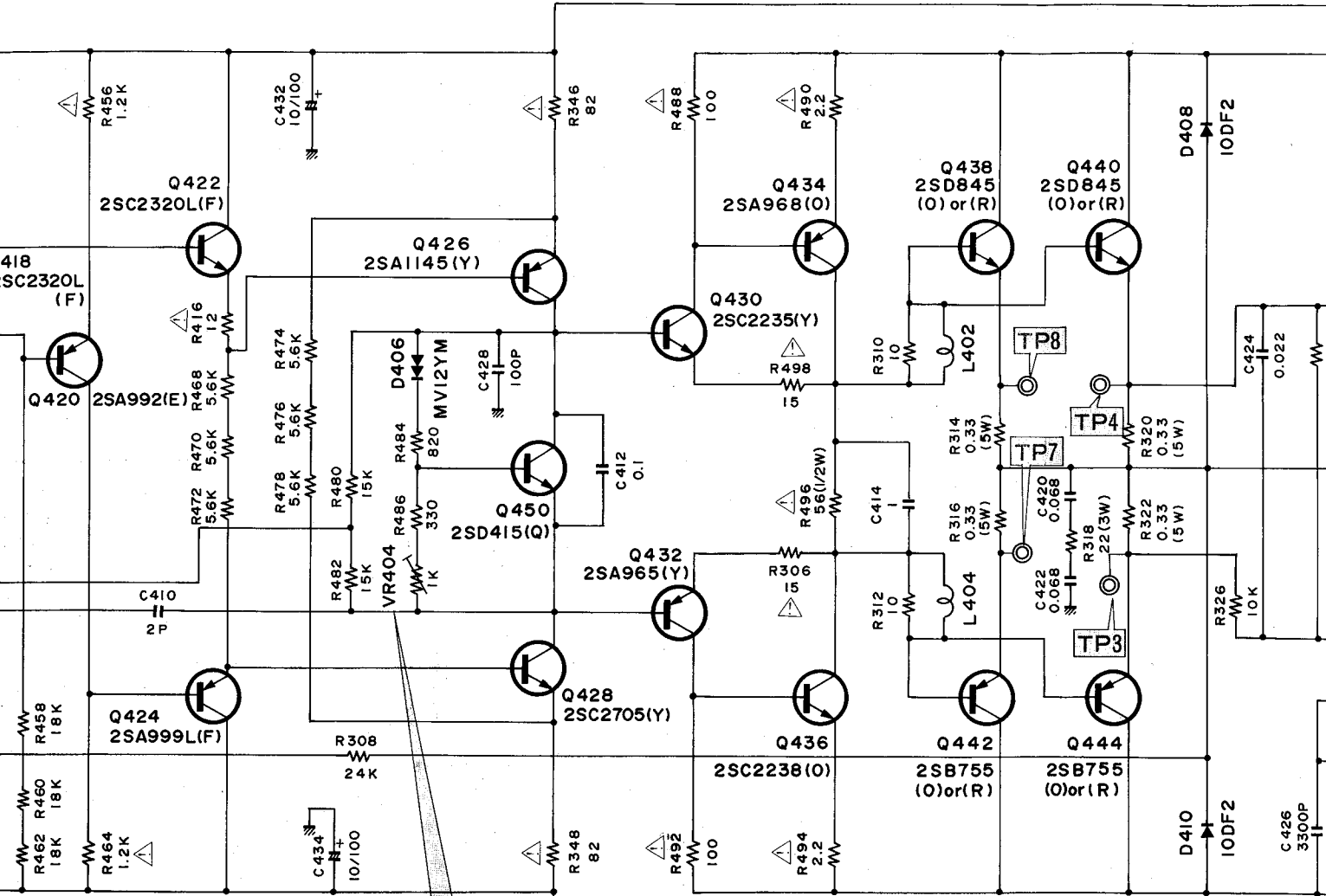

IDLING CURRENT ADJ. (Rch)

UT UNIT.

FETY
PARTS.

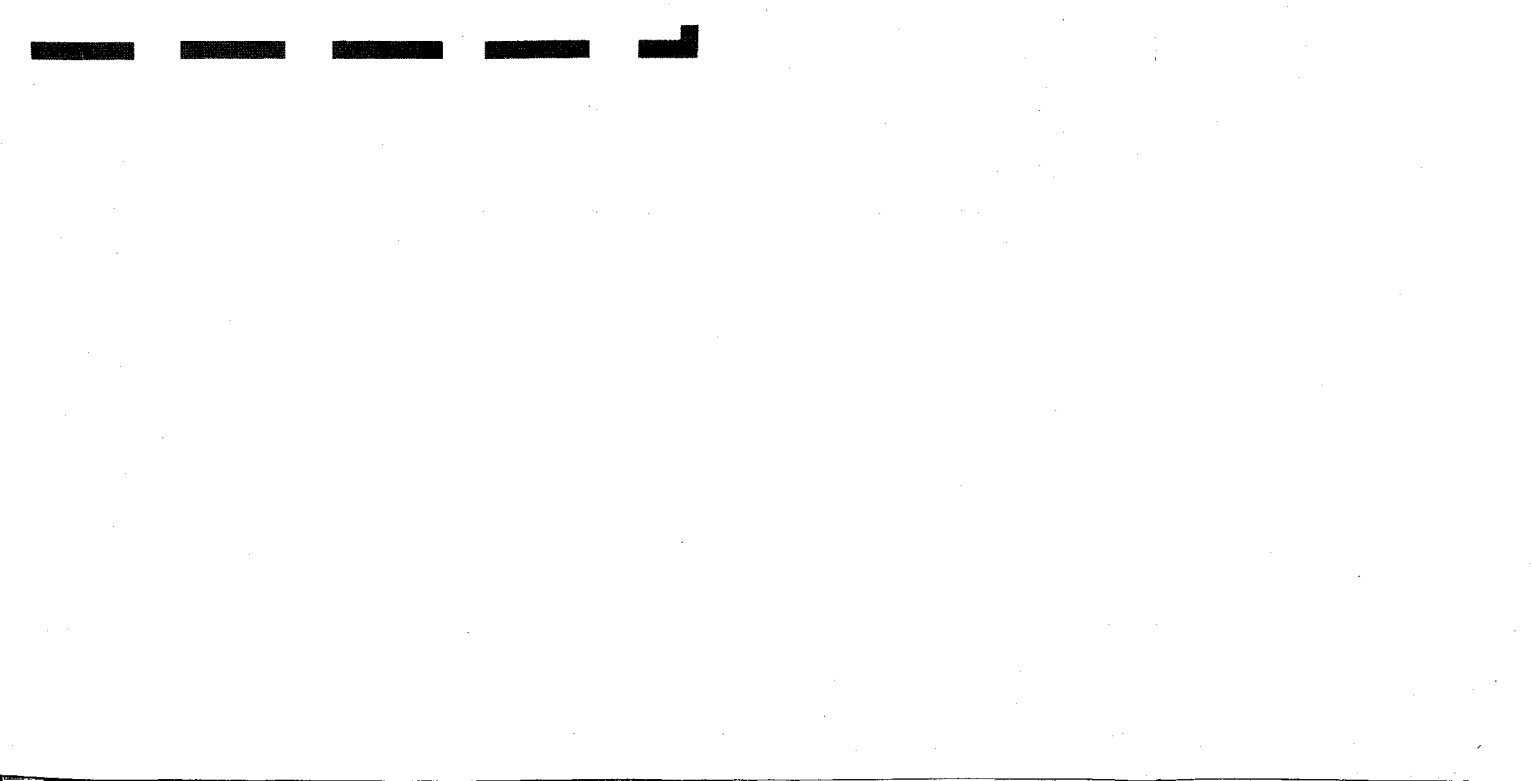
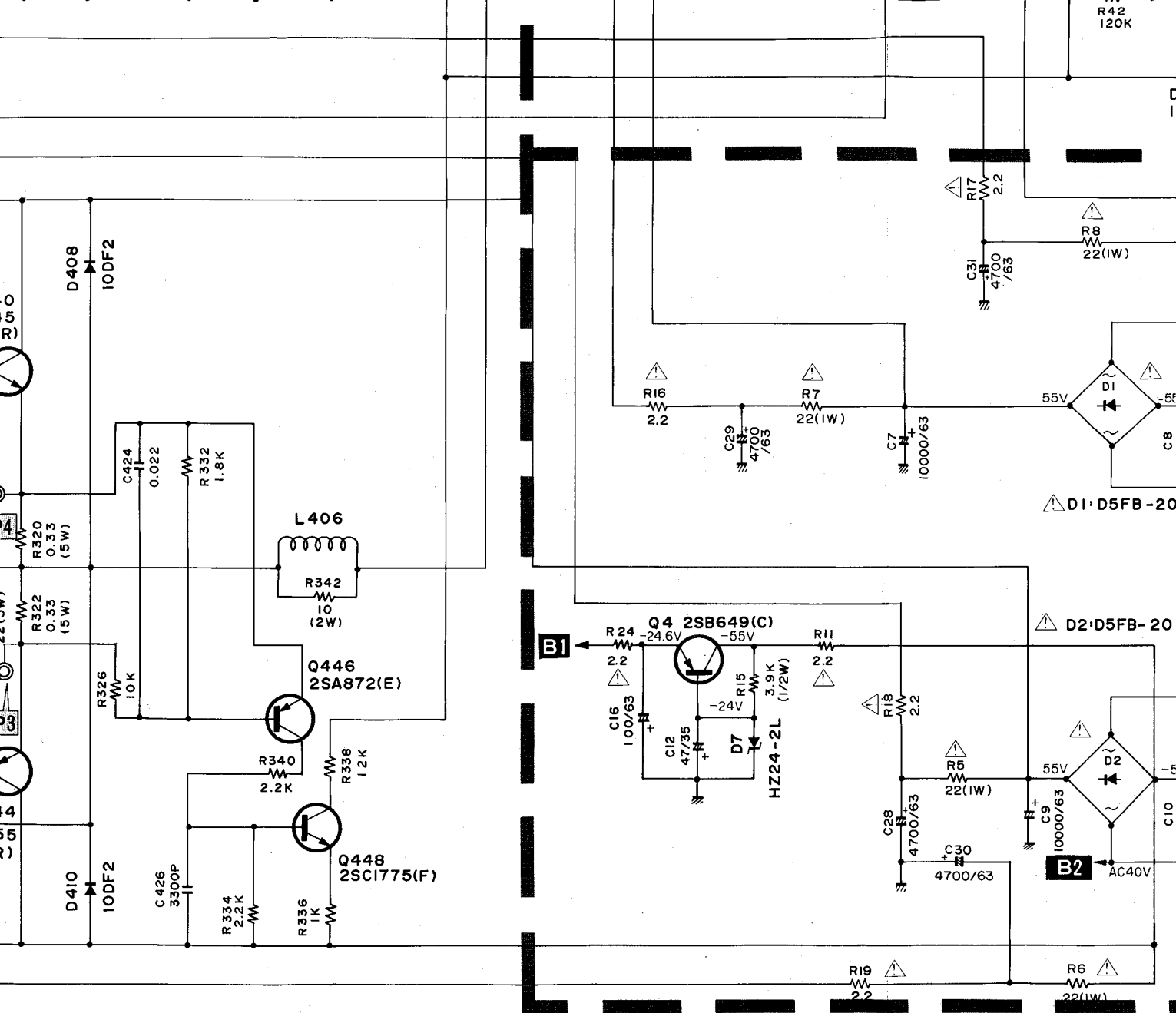

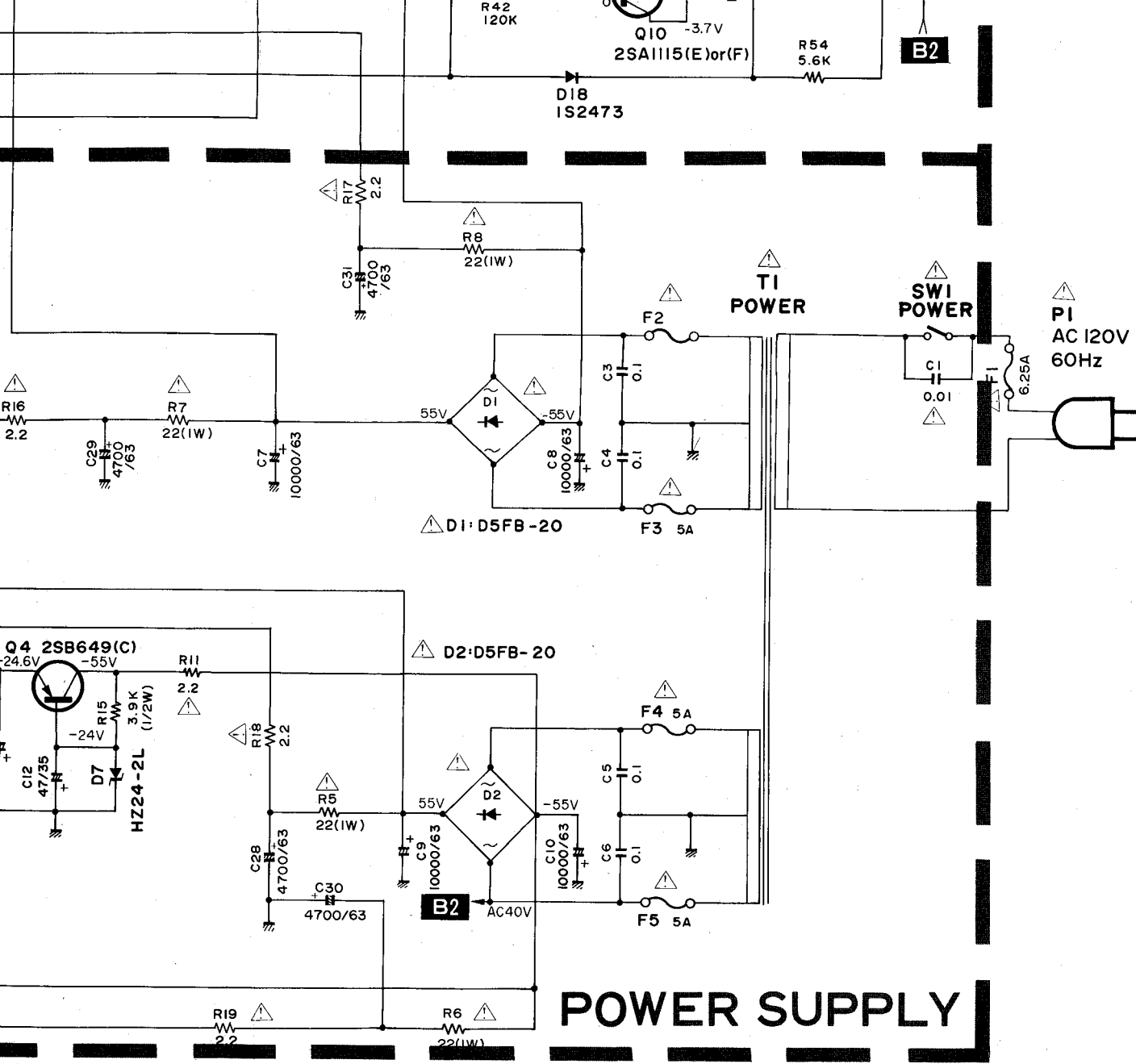

WIRING DIAGRAM

P1 AC120V, 60HZ

T1 POWER

TE1 SPEAKER OUT LEFT RIGHT

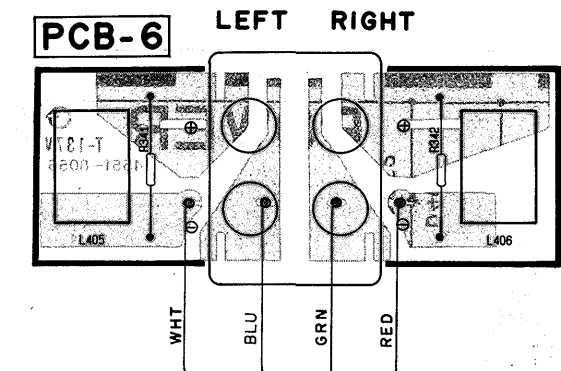

PCB-3

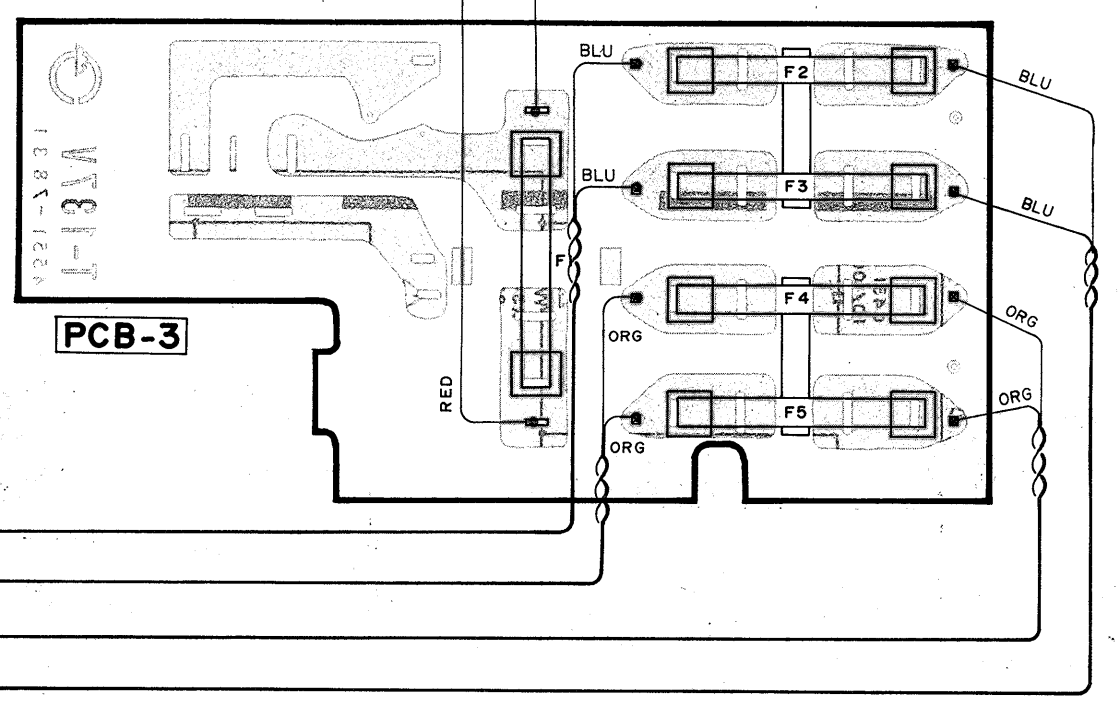

EARTH BRACKET

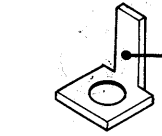

PCB-4

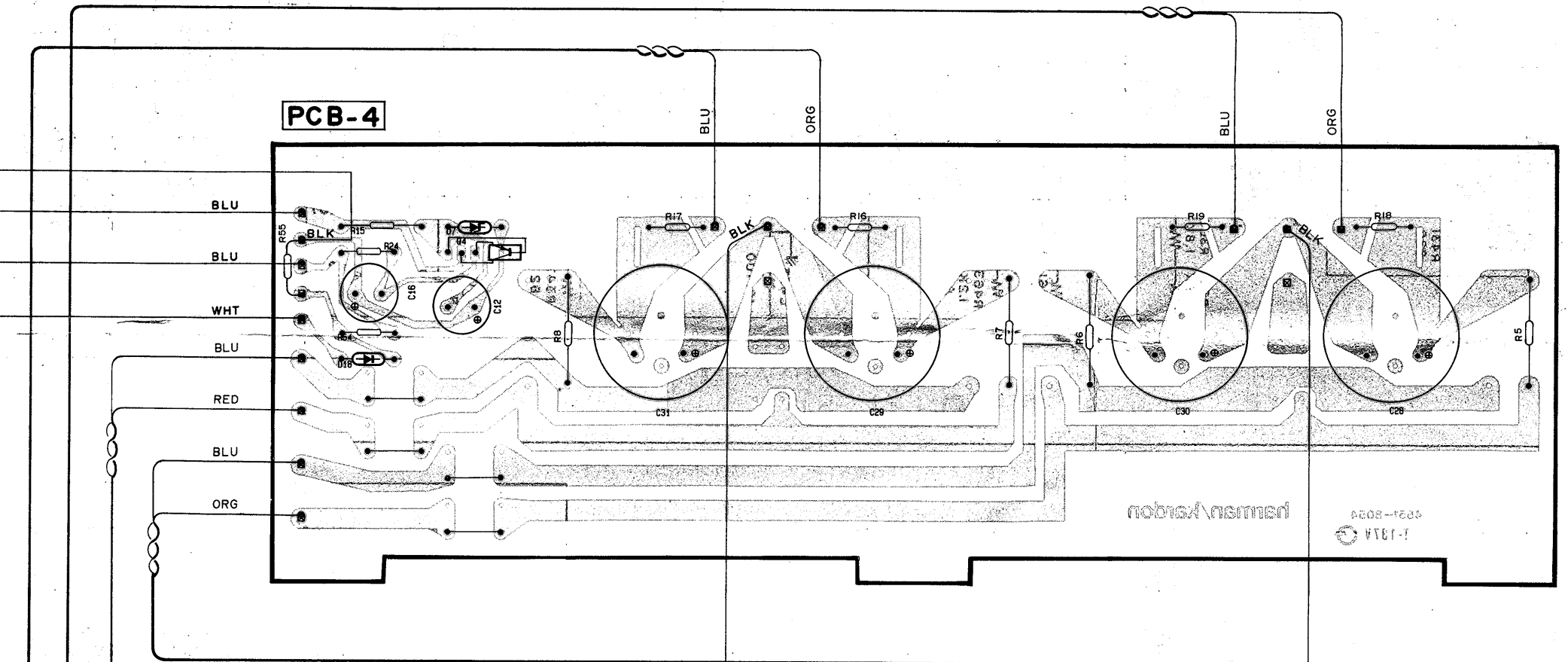

IDLING CURRENT ADJ. (Lch)

DC BALANCE ADJ. (Rch)

PCB-2

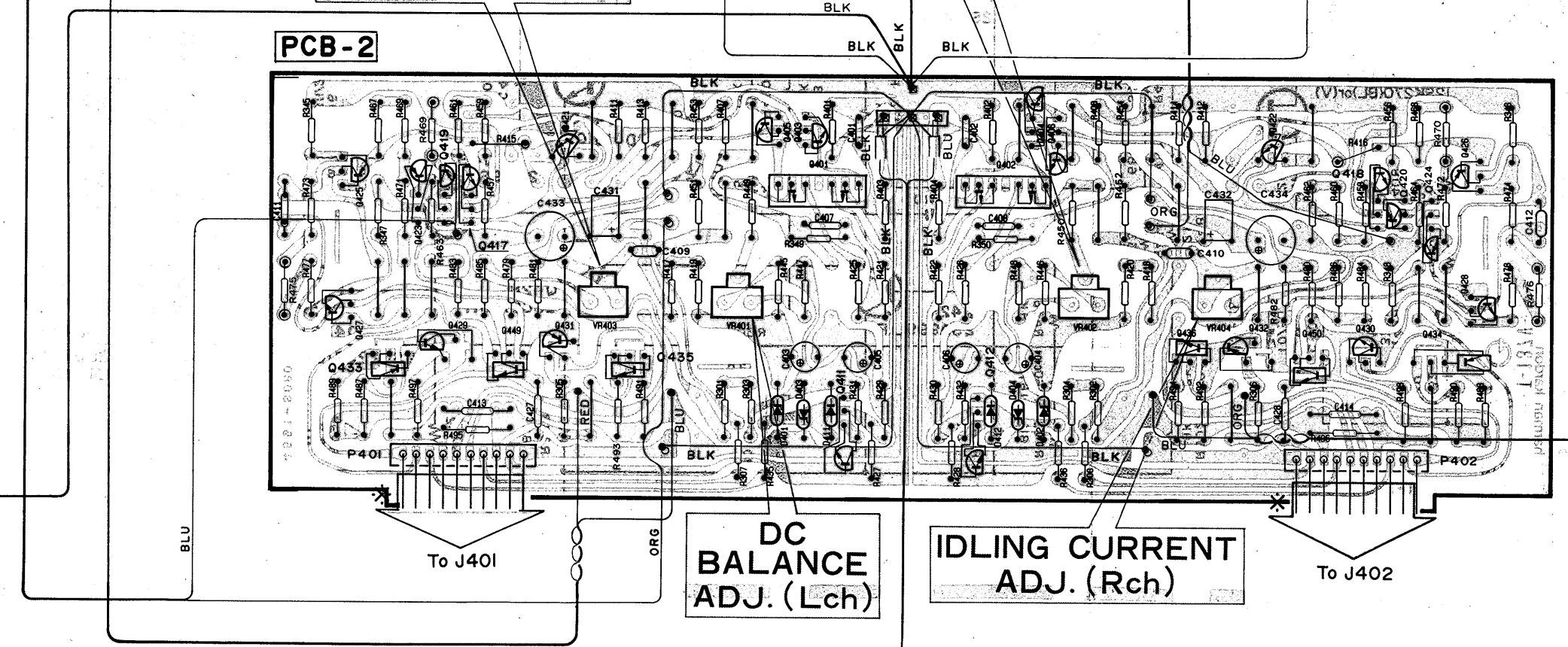

DC BALANCE ADJ. (Lch)

IDLING CURRENT ADJ. (Rch)

PCB-5

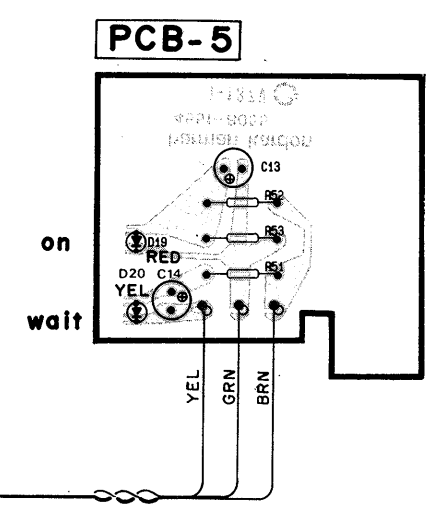

PCB-7

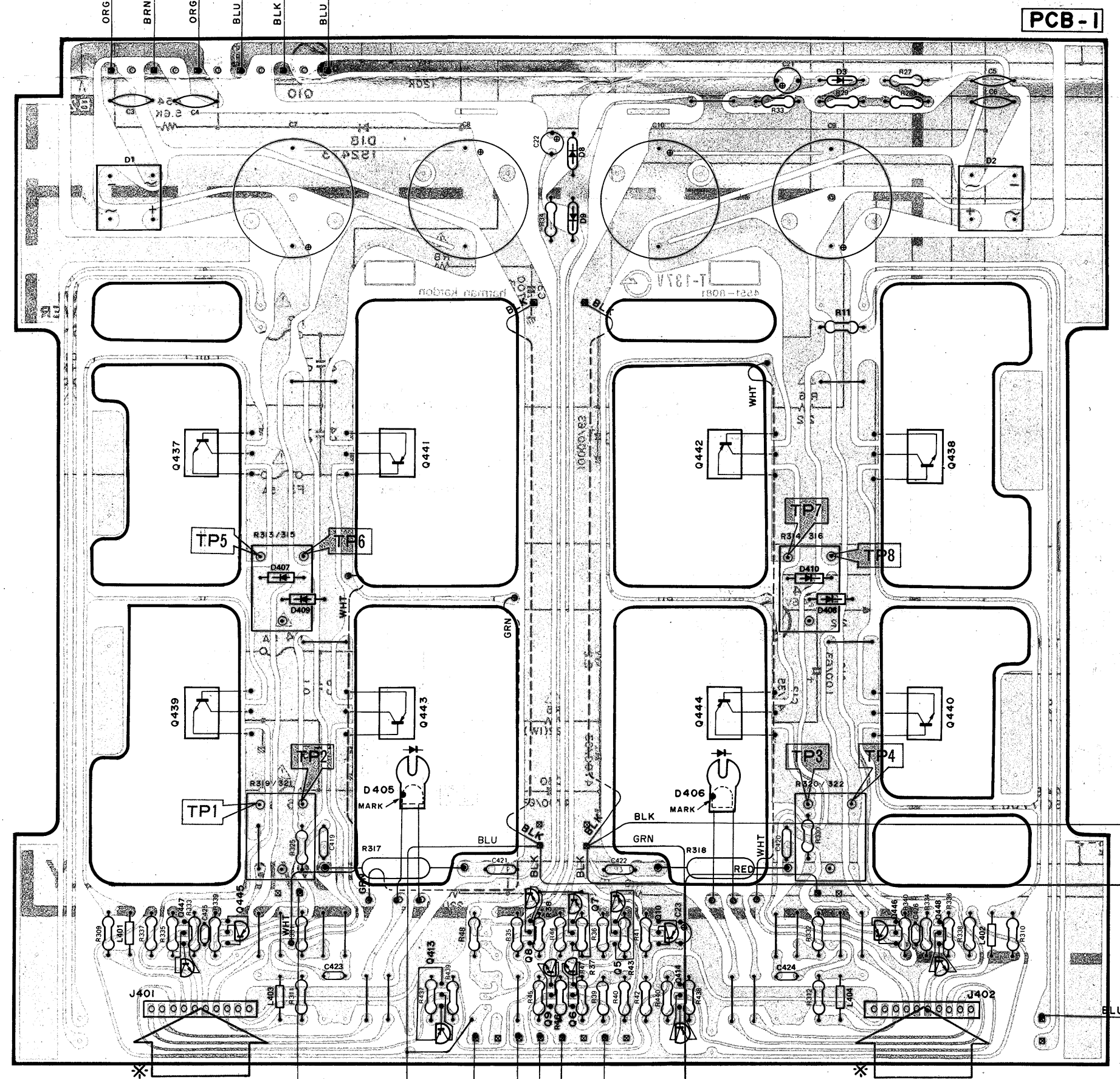
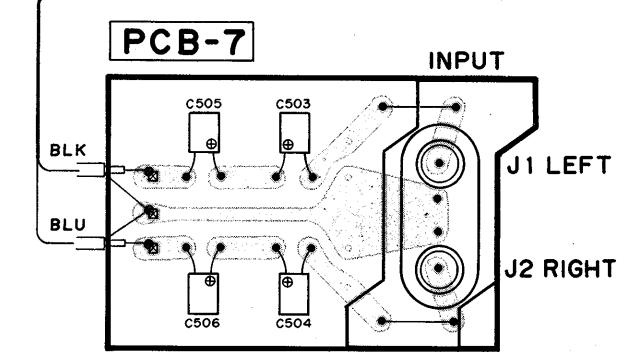

PIN CONNECTION DIAGRAM OF TRANSISTORS AND DIODES.

2SB649(C) : Q4	2SA1115(E)or(F) : Q5, 7, 8, 10, 413, 414
2SD415(Q) : Q449, 450	2SC2603(E)or(F) : Q6, 9
2SK270(BL)or(V) : Q401, 402	
2SC1845(E) : Q403 ~ 406, 411, 412	2SA1145(Y) : Q425, 426, 411, 412
2SC2320(L) : Q417, 418, 421, 422	2SC2235(Y) : Q429, 430, 421, 422
2SA922(E) : Q419, 420	2SA965(Y) : Q431, 432, 2SA872(E) : Q445, 446
2SA999(L) : Q423, 424	2SC1775(F) : Q447, 448
2SA968(O) : Q433, 434	2SD845(O)or(R) : Q437 ~ 440
2SC2238(O) : Q435, 436	2SB755(O)or(R) : Q441 ~ 444
D5FB20 : D1, 2	IS2471 : D3
	HZ24-2L : D7
	RD13EB3 : D8
	IS2472 : D9
	IS2473 : D18
	HZ15-2L : D401 ~ 404
10DF2 : D407 ~ 410	GL5HD10 : D19
	GL5HY10 : D20
MV12YM : D405, 406	
MV5W : D411, 412	

WIRE COLOR ABBREVIATIONS
RED : Red GRN : Green
WHT : White ORG : Orange
BLK : Black YEL : Yellow
BLU : Blue BRN : Brown

WIRING DIAGRAM

P1
AC 120V, 60Hz

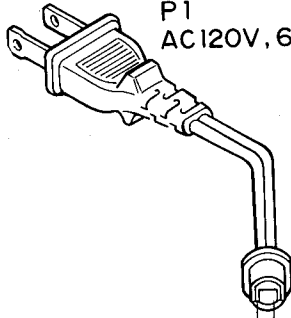

C01
WHT

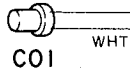

C1
0.01μF

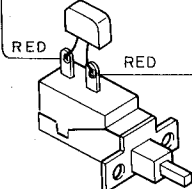

SW1
POWER

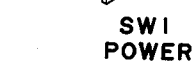

T1
POWER

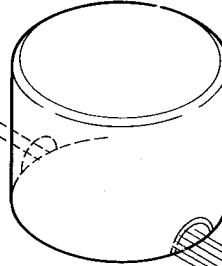

BRN

BLK

ORG

BRN

ORG

BLU

BLK

BLU

C3

C4

D7

C8

C10

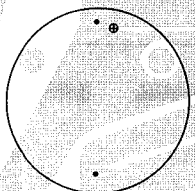
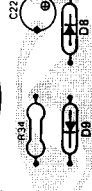
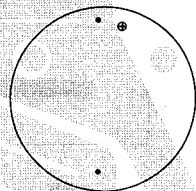
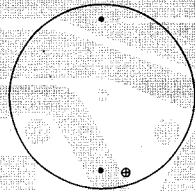
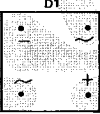

C21

R33

WHT

1

2

3

4

5

6

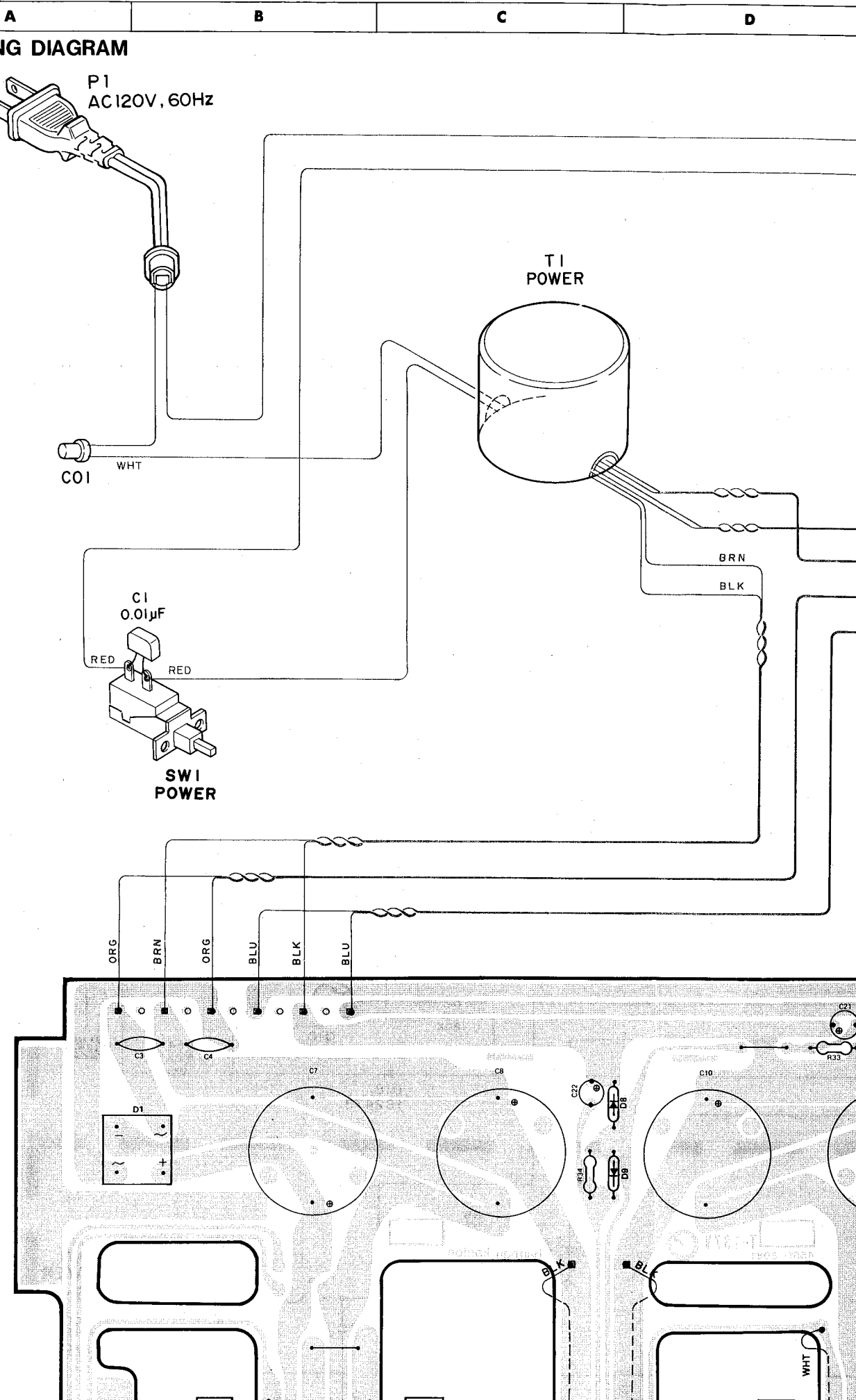

TEI
SPEAKER OUT
LEFT RIGHT

PCB-6

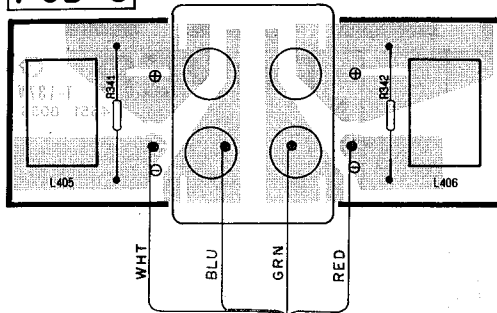

PCB-3

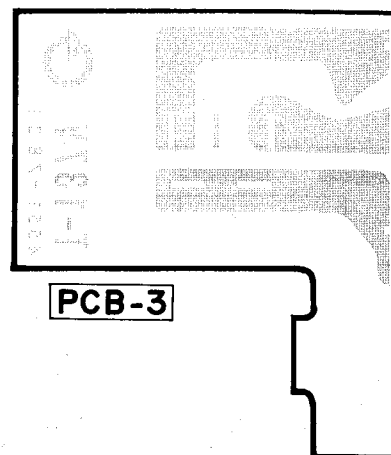

PCB-1

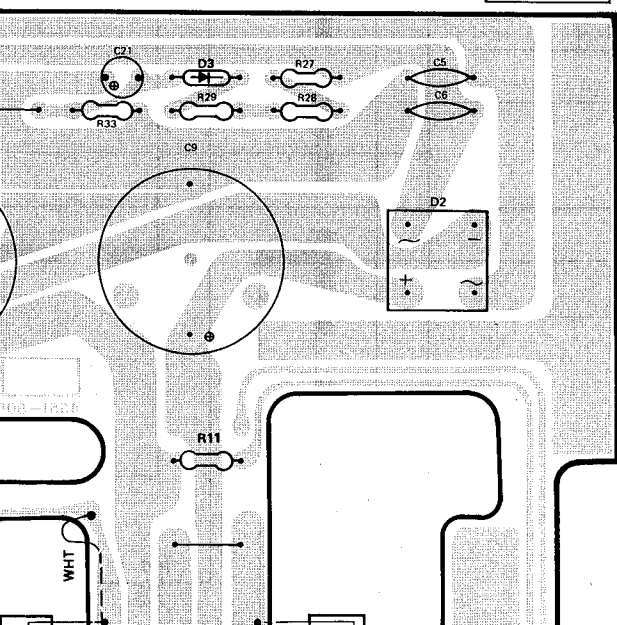

PCB-4

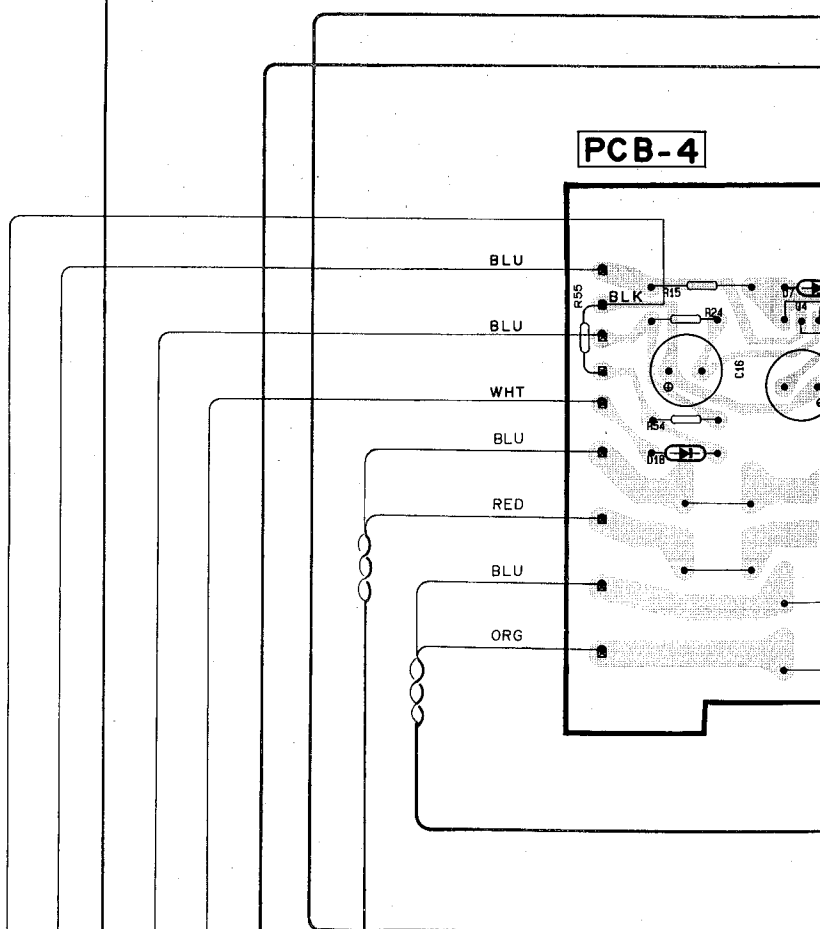

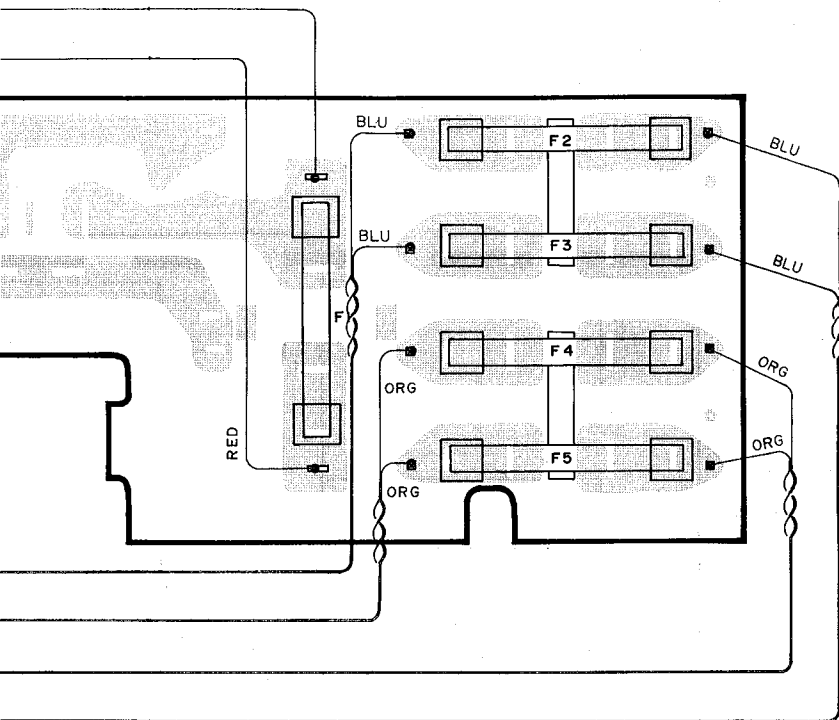

EARTH BRACKET

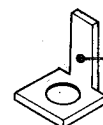

CB-4

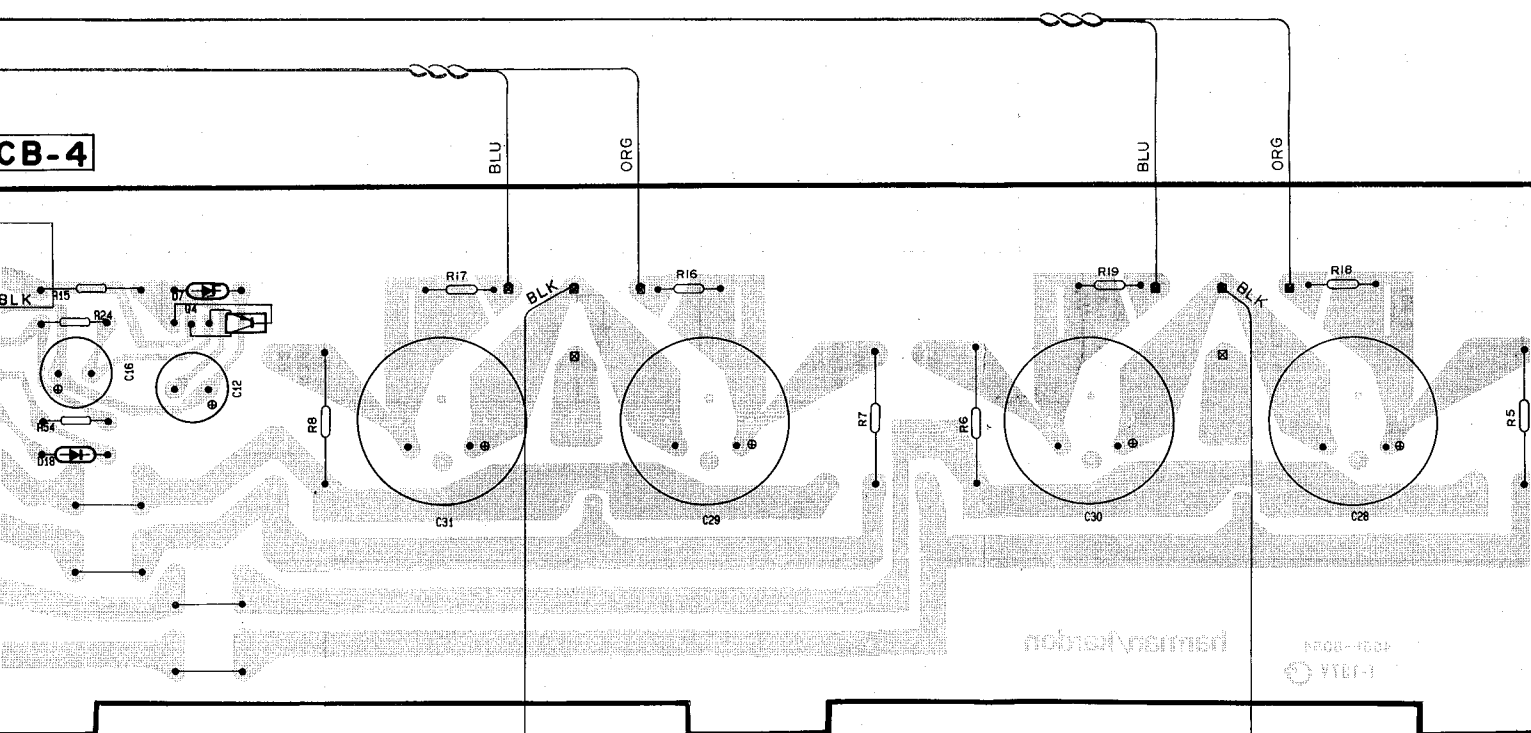

not to be removed

FIGURE 100
YTD-1

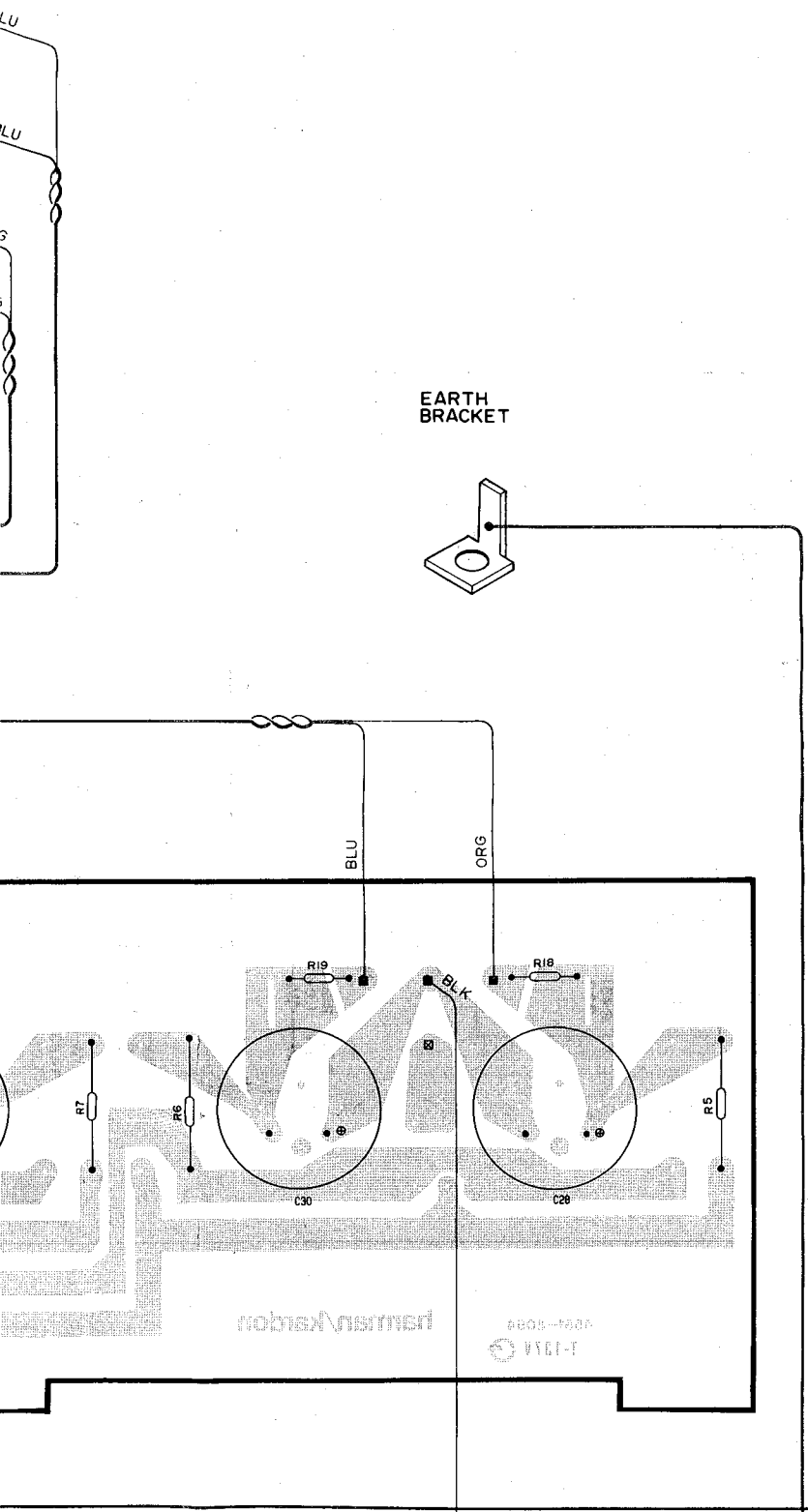

PIN CONNECTION DIAGRAM OF TRANSISTORS AND DIODES.

<p>2SB649(C) : Q4 2SD415(Q) : Q449, 450</p>	<p>2SA1115(E)or(F) : Q5, 7, 8, 10, 413, 414 2SC2603(E)or(F) : Q6, 9</p>

2SK270(BL)or(V) : Q401, 402

5

6

7

8

9

10

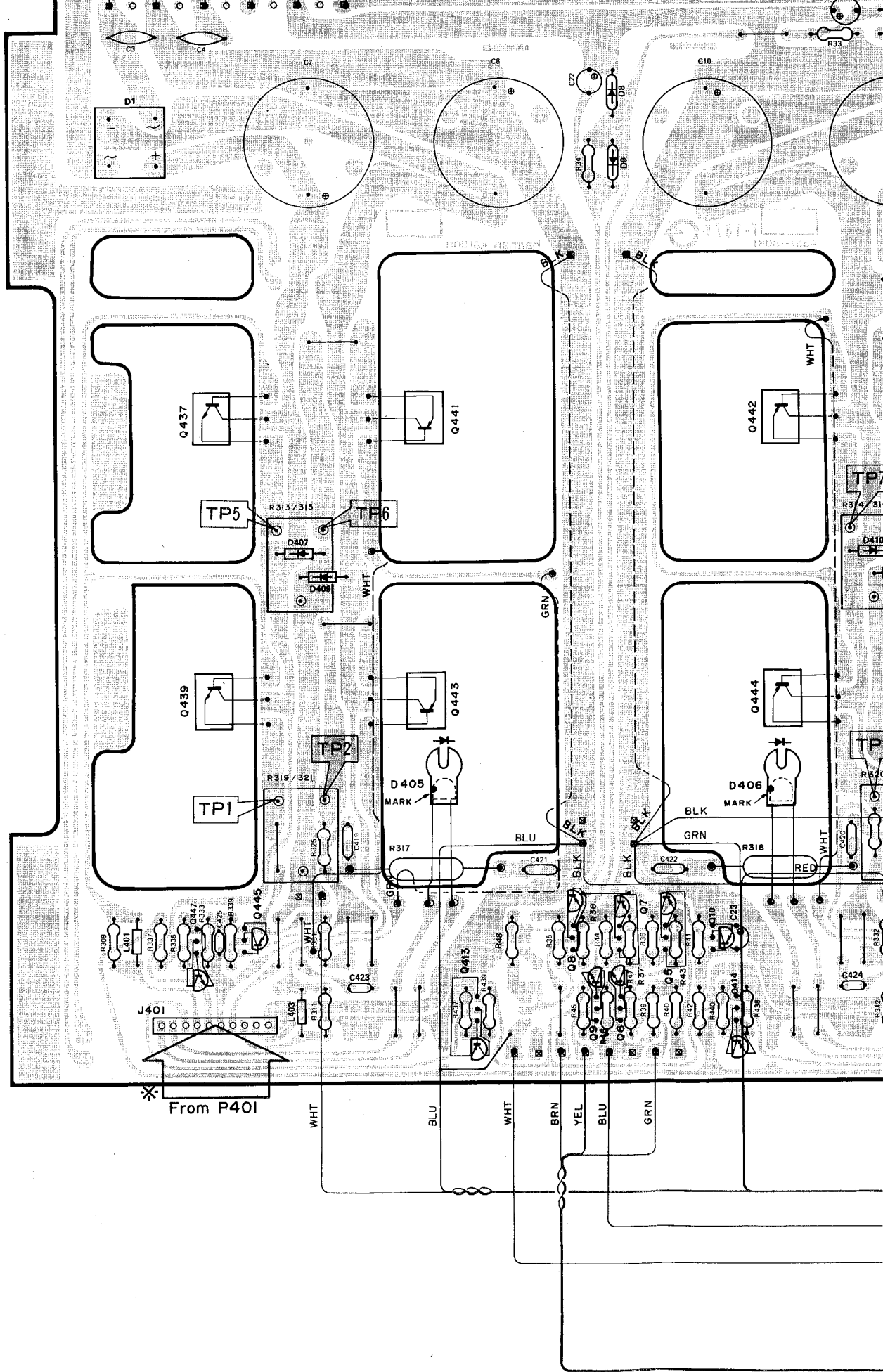

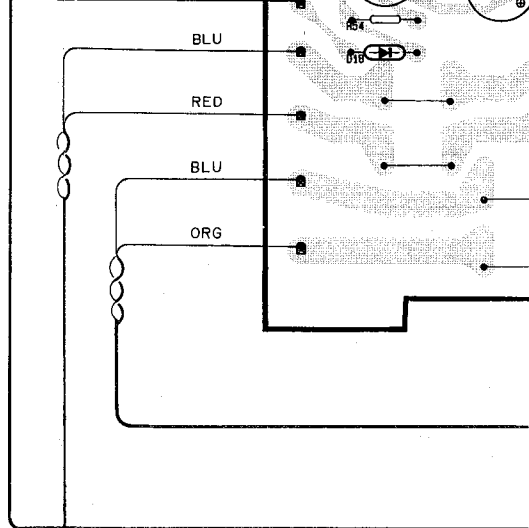
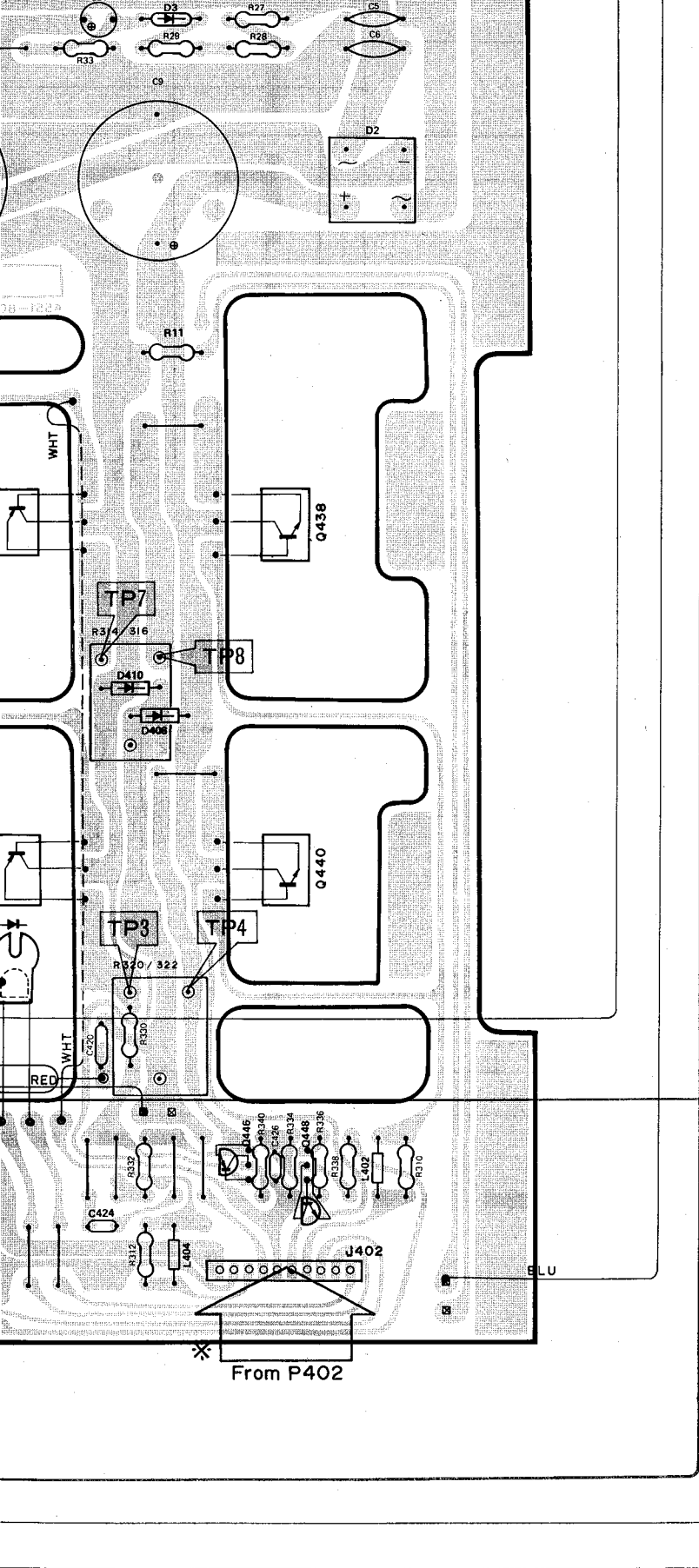

IDLING C
ADJ. (

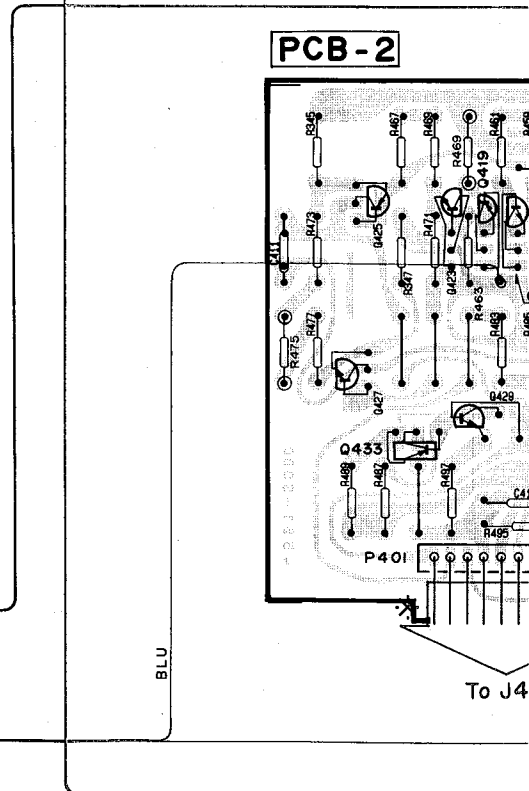

PCB-5

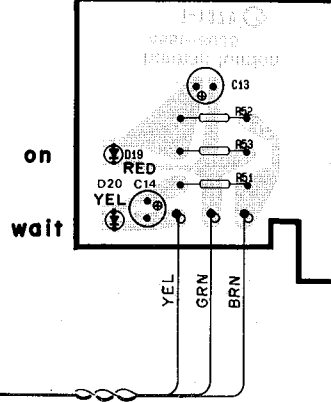

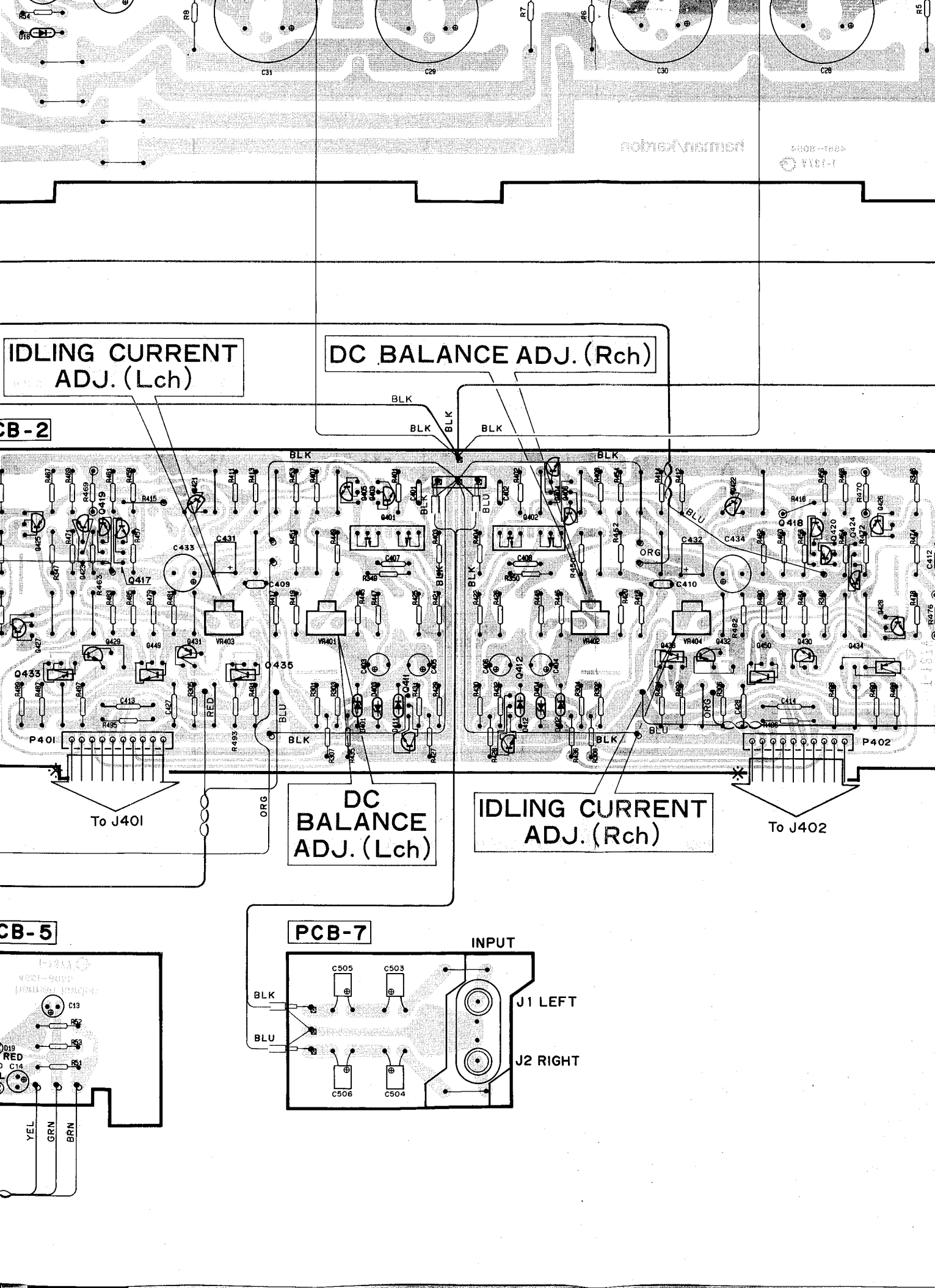

IDLING CURRENT ADJ. (Lch)

DC BALANCE ADJ. (Rch)

CB-2

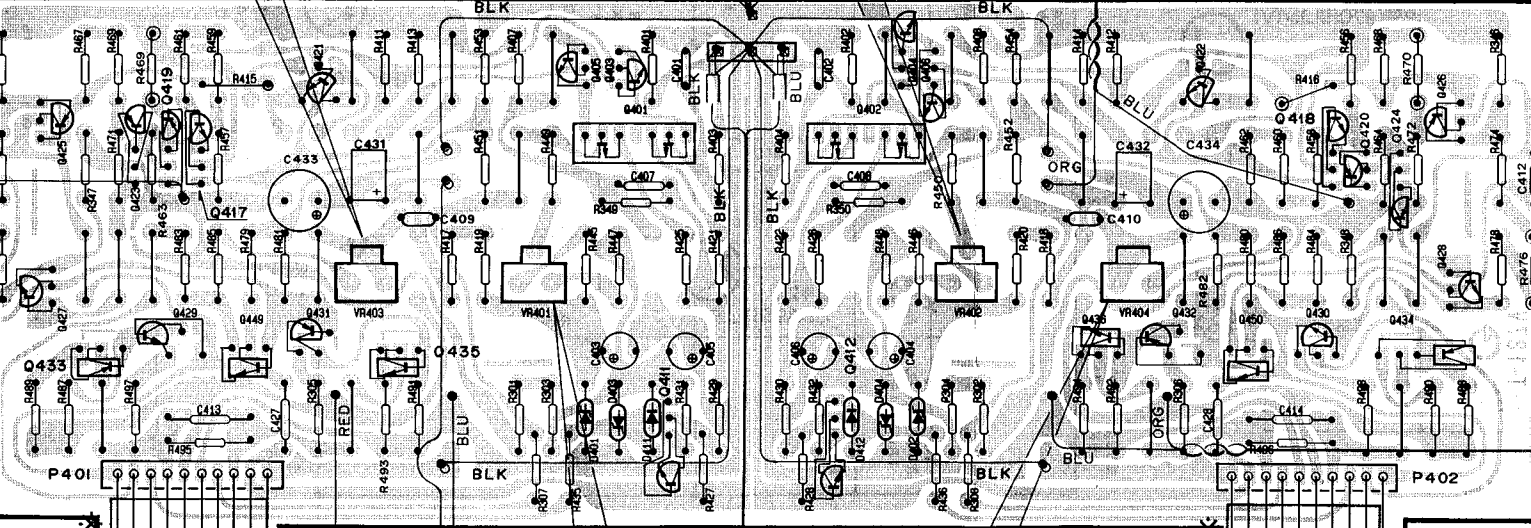

To J401

To J402

DC BALANCE ADJ. (Lch)

IDLING CURRENT ADJ. (Rch)

CB-5

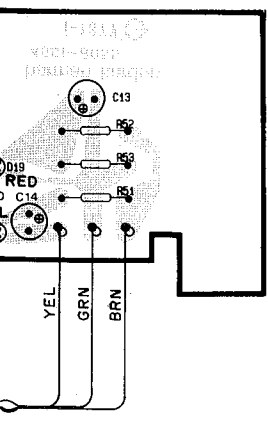

PCB-7

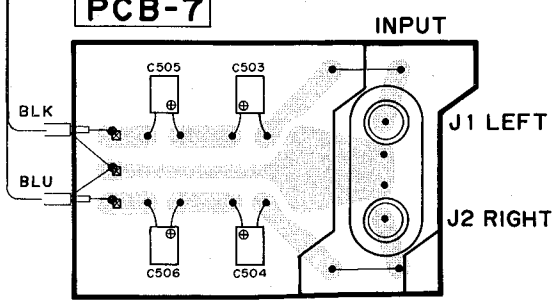

INPUT

J1 LEFT

J2 RIGHT

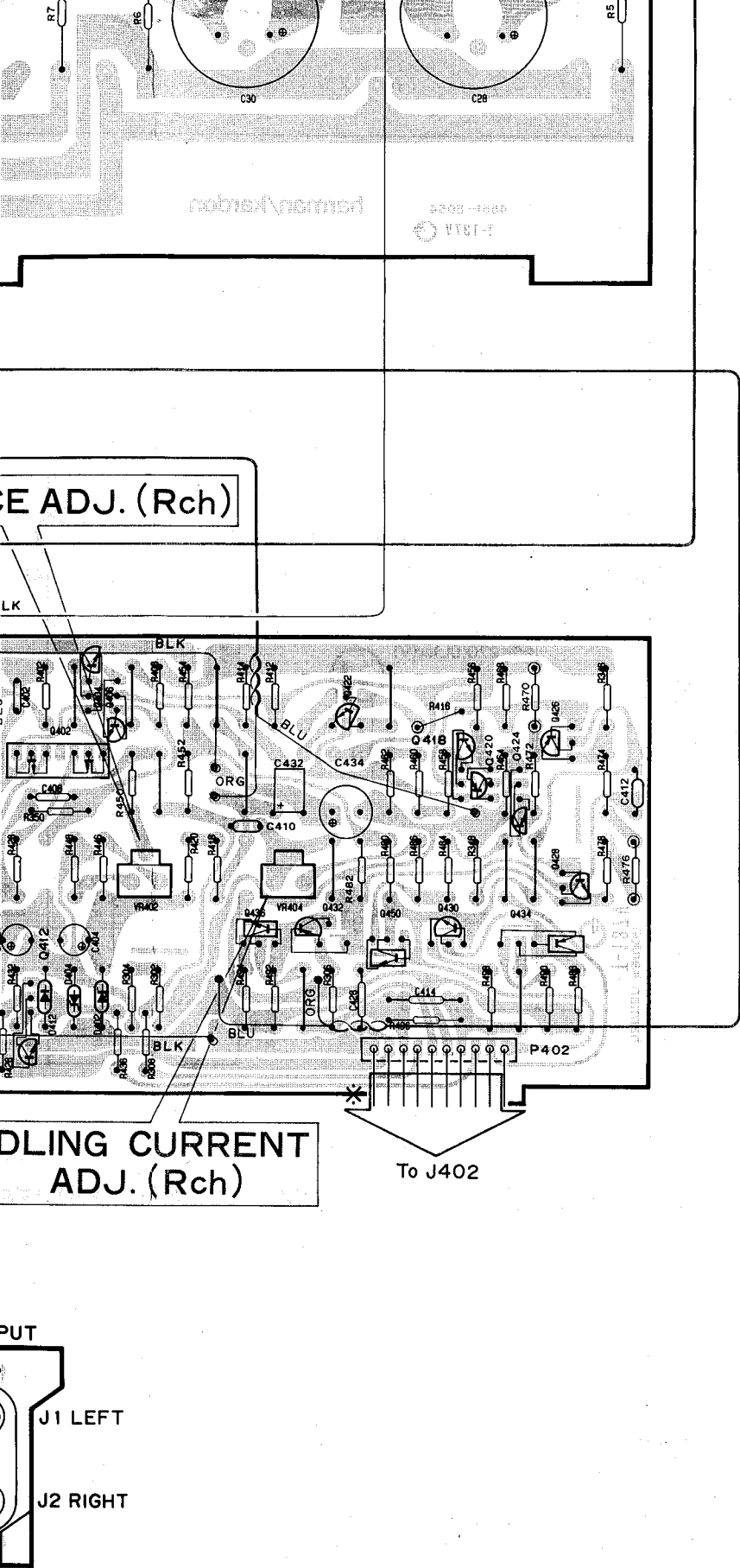

PIN CONNECTION DIAGRAM OF TRANSISTORS AND DIODES.

2SB649(C) : Q4
2SD415(O) : Q449, 450

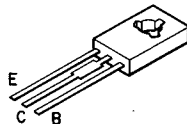

2SA1115(E)or(F) : Q5, 7, 8, 10, 413, 414
2SC2603(E)or(F) : Q6, 9

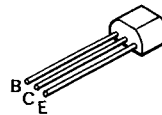

2SK270(BL)or(V) : Q401, 402

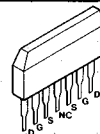

2SC1845(E) : Q403 ~ 406, 411, 412
2SC2320L(F) : Q417, 418, 421, 422
2SA922(E) : Q419, 420
2SA999L(F) : Q423, 424

2SA1145(Y) : Q425, 426
2SC2705(Y) : Q427, 428
2SC2235(Y) : Q429, 430
2SA965(Y) : Q431, 432
2SA872(E) : Q445, 446
2SC1775(F) : Q447, 448

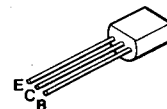

2SA968(O) : Q433, 434
2SC2238(O) : Q435, 436

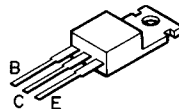

2SD845(O)or(R) : Q437 ~ 440
2SB755(O)or(R) : Q441 ~ 444

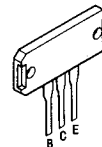

D5FB20 : D1, 2

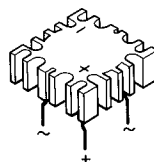

1S2471 : D3
HZ24-2L : D7
RD13EB3 : D8
IS2472 : D9
IS2473 : D18
HZ15-2L : D401 ~ 404

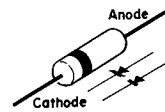

10DF2 : D407 ~ 410

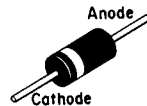

GL5HD10 : D19
GL5HY10 : D20

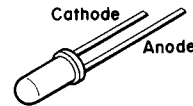

MV12YM : D405, 406
MV5W : D411, 412

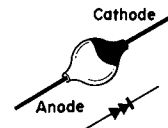

WIRE COLOR ABBREVIATIONS

- RED : Red
- WHT : White
- BLK : Black
- BLU : Blue
- GRN : Green
- ORG : Orange
- YEL : Yellow
- BRN : Brown