

Service Manual

Telephone Equipment

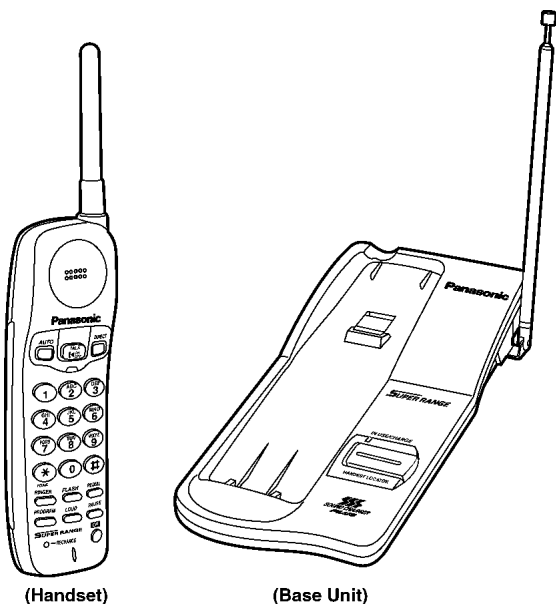

(Handset)

(Base Unit)

KX-TC1205RUB
KX-TC1205RUW
KX-TC1205RUS
KX-TC1205RUF

Cordless Phone

Black Version
 White Version
 Silver Version
 Blue Version
 (for Russia)

SPECIFICATIONS

General

Modulation:	FM, 5kHz Deviation	Pause:	3.5 seconds per pause
Frequency Stability:	± 2.5 kHz	Memory Capacity:	10 telephone numbers, up to 16 digits per station
Dial Type:	Tone (DTMF)/Pulse		
Redial:	Last dialed number each time the Redial button is pressed		

	Base Unit	Handset
Power Source: (Receiver Section)	AC adaptor PQLV16CEZ (DC 12V)	Built-in rechargeable Ni-Cd battery
Receiving Frequency:	10 channels within 39.775 to 40.000 MHz	10 channels within 30.075 to 30.300 MHz
Adjacent Channel Rejection:	40 dB	40 dB
Sensitivity: (Transmitter Section)	1dB μ V for 20 dB S/N	2 dB μ V for 20 dB S/N
Transmitting Frequency:	10 channels within 30.075 to 30.300 MHz	10 channels within 39.775 to 40.000 MHz
Jacks:	DC IN, Telephone line	
Antenna:	Telescopic	Rubber Flexible
Speaker:		1 ³ / ₁₆ " (3 cm) dynamic
Microphone:		Condenser microphone
Dimensions (H X W X D):	2 ¹³ / ₃₂ " x 4 ⁹ / ₃₂ " x 8 ³ / ₁₆ " (61 x 109 x 208mm)	10 ¹ / ₂ " x 2 ¹ / ₈ " x 1 ³ / ₁₆ " (267 x 54 x 40mm)
Weight:	0.57 lbs. (260 g)	0.29 lbs. (130g) with battery

Design and specifications are subject to change without notice.

Panasonic

© 2002 Kyushu Matsushita Electric Co., Ltd. All rights reserved. Unauthorized copying and distribution is a violation of law.

WARNING

This service information is designed for experienced repair technicians only and is not designed for use by the general public. It does not contain warnings or cautions to advise non-technical individuals of potential dangers in attempting to service a product. Products powered by electricity should be serviced or repaired only by experienced professional technicians. Any attempt to service or repair the product or products dealt with in this service information by anyone else could result in serious injury or death.

When you note the serial number, write down all 11 digits. The serial number may be found on the bottom of the unit.

FOR SERVICE TECHNICIANS

ICs and LSIs are vulnerable to static electricity.

When repairing, the following precautions will help prevent recurring malfunctions.

1. Cover plastic parts boxes with aluminum foil.
2. Ground the soldering irons.
3. Use a conductive mat on worktable.
4. Do not grasp IC or LSI pins with bare fingers.

CAUTION

Danger of explosion if battery is incorrectly replaced.

Replace only with the same or equivalent type recommended by the manufacturer.

Dispose of used batteries according to the manufacturer's Instructions.

CONTENTS

	Page		Page
1 BATTERY	4	8 ADJUSTMENTS (BASE UNIT)	23
1.1. Recharge	4	8.1. Test Mode Flow Chart (Base Unit)	23
1.2. Battery information	4	8.2. How to change the channel	24
2 BATTERY REPLACEMENT	5	8.3. Adjustment	24
3 LOCATION OF CONTROLS	6	8.4. Adjustment Standard (Base Unit)	25
3.1. Base Unit	6	9 ADJUSTMENTS (HANDSET)	26
3.2. Handset	6	9.1. Test Mode Flow Chart (Handset)	26
4 CONNECTION	7	9.2. How to change the channel	27
4.1. Adding Another Phone	9	9.3. Adjustment	27
5 OPERATIONS	10	9.4. Adjustment Standard (Handset)	28
5.1. Making Calls	10	10 RF SPECIFICATION	30
5.2. Answering Calls	10	10.1. Base Unit	30
5.3. Storing Phone Numbers in Memory	11	10.2. Handset	30
5.4. Storing a Phone Number in the DIRECT Button	11	11 HOW TO CHECK THE HANDSET SPEAKER	30
5.5. Dialing a Stored Number	12	12 FREQUENCY TABLE (MHz)	31
5.6. Dialing a Stored Number in the DIRECT Button	12	13 EXPLANATION OF CPU DATA COMMUNICATION	32
5.7. FLASH Button	13	13.1. STAND-BY -> TALK, TALK -> STAND-BY	32
6 DISASSEMBLY INSTRUCTIONS	14	13.2. Ringing	33
7 TROUBLESHOOTING GUIDE	16	13.3. Changing the Channel	34
7.1. Check Power	17	13.4. Ports for transmitting and receiving of data	35
7.2. Bell Reception	18	13.5. Waveform of DATA used for cordless transmission and reception	35
7.3. Check Battery Charge	19	14 BLOCK DIAGRAM (BASE UNIT)	36
7.4. Check Link	20	15 BLOCK DIAGRAM (HANDSET)	37
7.5. Check Handset Transmission	22	16 CIRCUIT OPERATION	38
7.6. Check Handset Reception	22		

16.1. Outline	38	23 ACCESSORIES AND PACKING MATERIALS	52
16.2. Power Supply Circuit	39	24 REPLACEMENT PARTS LIST	53
16.3. Reset Circuit (Base Unit)	40	24.1. Base Unit	53
16.4. Charge Circuit	41	24.2. Handset	56
16.5. Telephone Line Interface	41	24.3. ACCESSORIES AND PACKING MATERIALS	58
16.6. Transmitter/Receiver	42	25 FOR SCHEMATIC DIAGRAM	59
16.7. Signal Route	44	25.1. Base Unit (SCHEMATIC DIAGRAM (Base Unit))	59
17 CIRCUIT OPERATION (HANDSET)	45	25.2. Handset (SCHEMATIC DIAGRAM (Handset))	59
17.1. Reset Circuit (Handset)	45	26 SCHEMATIC DIAGRAM (Base Unit)	60
17.2. Battery Low / Power Down Detector	46	26.1. Base Unit	60
18 CPU DATA (Base Unit)	47	26.2. RF Unit (Base Unit)	61
18.1. IC2	47	27 SCHEMATIC DIAGRAM (Handset)	62
19 CPU DATA (Handset)	48	27.1. Handset	62
19.1. IC2	48	27.2. RF Unit (Handset)	63
20 HOW TO REPLACE FLAT PACKAGE IC	49	28 CIRCUIT BOARD (Base Unit)	65
20.1. Preparation	49	28.1. Component View	65
20.2. Procedure	49	28.2. Flow Solder Side View	66
20.3. Modification Procedure of Bridge	49	29 CIRCUIT BOARD (Handset)	67
21 CABINET AND ELECTRICAL PARTS LOCATION (BASE UNIT)	50	29.1. Component View	67
22 CABINET AND ELECTRICAL PARTS LOCATION (HANDSET) ..	51	29.2. Flow Solder Side View	68

1 BATTERY

1.1. Recharge

When the RECHARGE indicator flashes or the unit beeps intermittently, place the handset on the base unit for 15 hours.

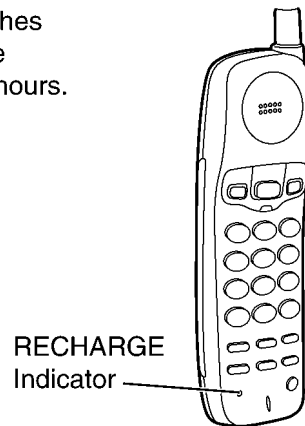

1.2. Battery information

After your Panasonic battery is fully charged:

Operation	Approx. battery life
While in use (TALK)	Up to about 5 hours
While not in use (Stand-by)	Up to about 14 days

- The battery operating time may vary depending on usage conditions and ambient temperature.
- **As preventative maintenance, clean the handset and the base unit charge contacts with a soft, dry cloth. Clean if the unit is subject to grease, dust or humidity.** Otherwise the battery may not charge properly.
- If the battery is fully charged, you do not have to place the handset on the base unit until the RECHARGE indicator flashes. This will maximize the battery life.
- The battery cannot be overcharged.

2 BATTERY REPLACEMENT

If the RECHARGE indicator flashes after being fully charged, replace the battery with a new Panasonic P-P301 (KX-A36A) battery. When replacing the battery, programmed information may be erased. Reprogram if necessary.

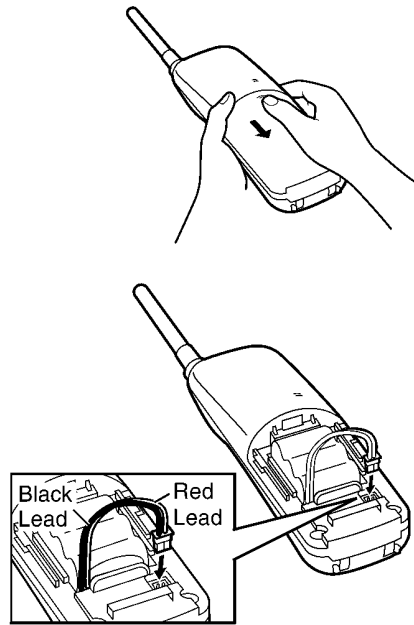

1 Press the notch on the battery cover firmly and slide it as indicated by the arrow.

2 Replace the battery and close the cover.

- Insert the battery plug into the connector as shown in the picture.
- Be sure wires are free from being pressed by the battery body or the handset cover.

3 Make sure to charge the new battery for about 15 hours.

3 LOCATION OF CONTROLS

3.1. Base Unit

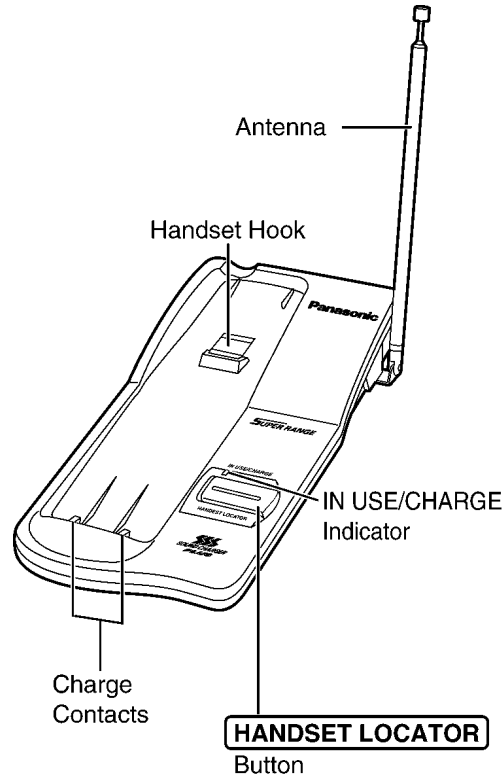

3.2. Handset

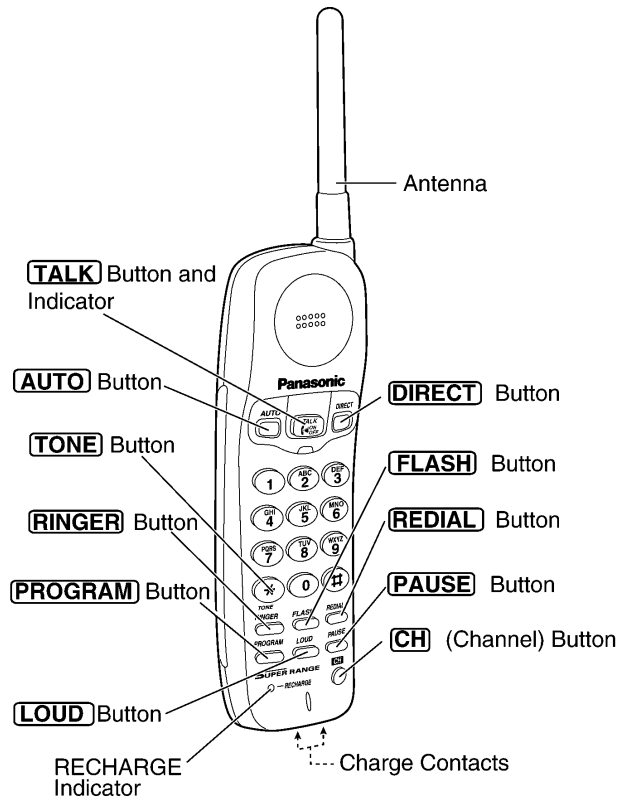

4 CONNECTION

1 Connect as shown.

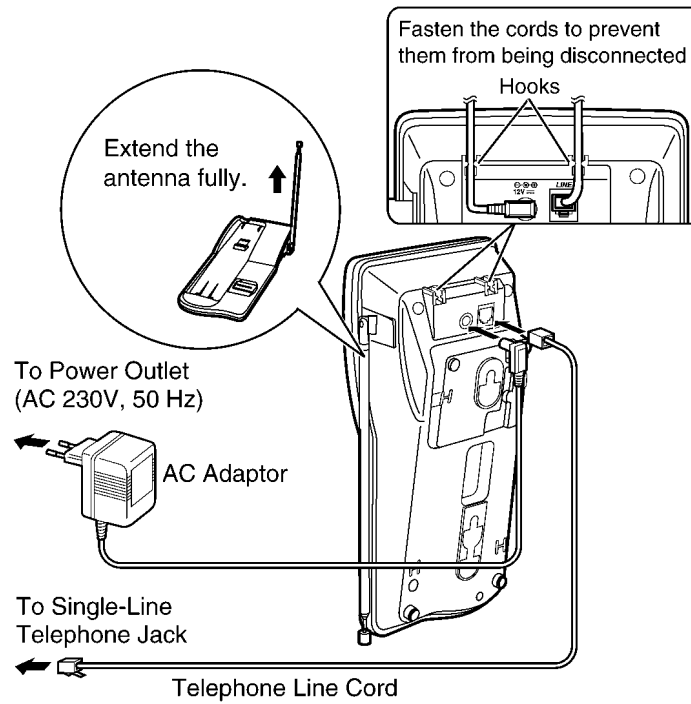

- USE ONLY WITH Panasonic AC ADAPTOR PQLV16CEZ.
- The AC adaptor must remain connected at all times.
(It is normal for the adaptor to feel warm during use.)
- When more than one unit is used, the units may interfere with each other. To prevent or reduce interference, please leave ample space between the base units.

2 Install the battery in the handset, and close the handset cover, locking it into place.

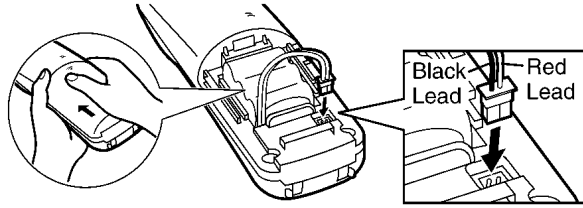

3 Charge the battery for about 15 hours.

- The IN USE/CHARGE indicator lights.

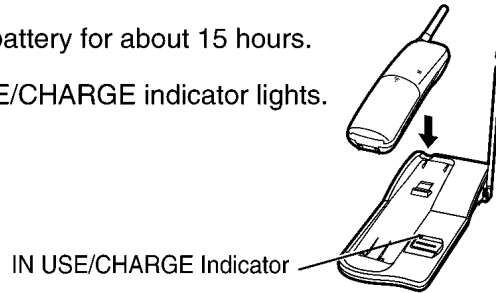

To select the dialing mode PULSE (preset) or TONE

If you have touch tone service, set to TONE. If rotary or pulse service is used, set to PULSE. Your phone comes from the factory set to PULSE. **The TALK indicator light must be off before programming.**

Press **PROGRAM** ➔ **AUTO** ➔ **OR** **PROGRAM** .

twice (PULSE)
 twice (TONE)

- A beep sounds.
- To cancel during programming, press **PROGRAM**, then restart from the beginning.
- If 3 beeps sound during programming, a wrong key was pressed. Start again from the beginning.

4.1. Adding Another Phone

This unit will not function during a power failue. To connect a standard telephone on the same line, use a telephone T-adaptor.

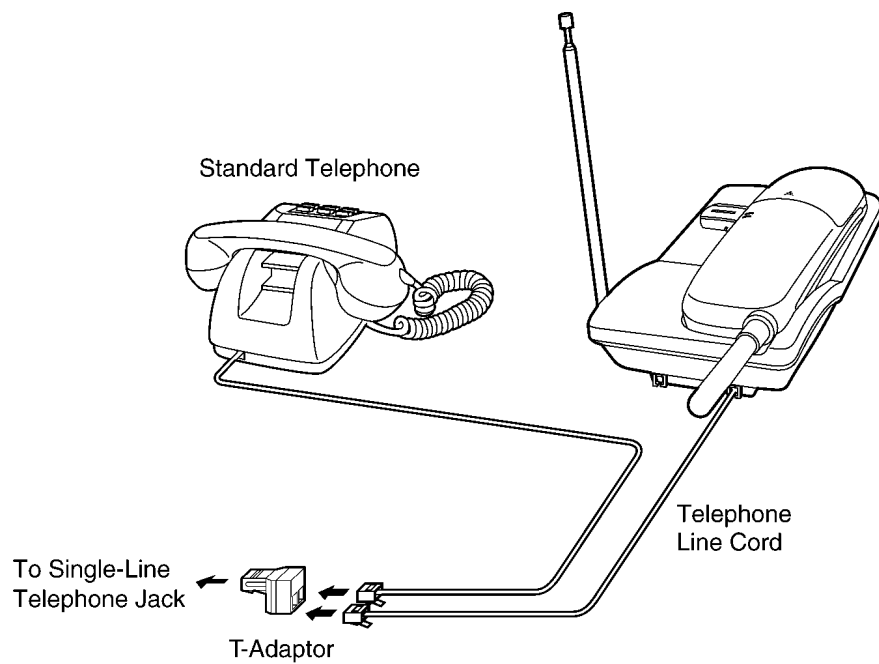

5 OPERATIONS

5.1. Making Calls

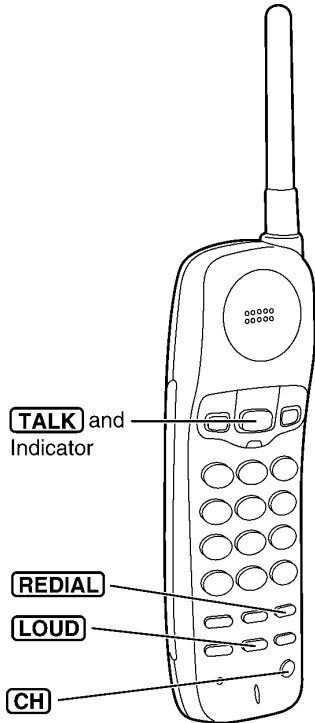

- 1 Press **TALK**.
 - The TALK indicator lights.
- 2 Dial a phone number.
- 3 To hang up, press **TALK** or place the handset on the base unit.
 - The indicator light goes out.

To redial the last number dialed on the handset

Press **TALK** → **REDIAL**.

To select the handset receiver volume

3 levels (HIGH, MEDIUM, LOW) are available. Press **LOUD** while talking.

- Each time you press the button, the volume level will change.
- When you replace the battery, the selected receiver volume setting will return to the factory set (MEDIUM). Reprogram if necessary.

If noise interferes with the conversation

Press **CH** to select a clearer channel or move closer to the base unit.

Backlit handset keypad

The handset dialing buttons will light when you press a button or lift the handset off the base unit, or when a call is received. The lights will go out a few seconds after pressing a button, lifting the handset or answering a call.

5.2. Answering Calls

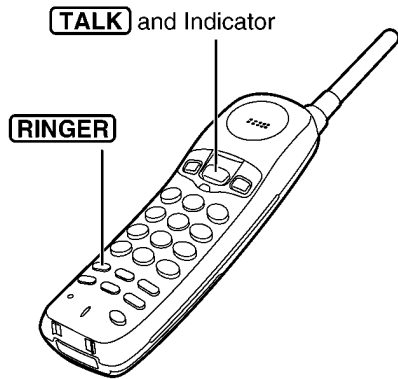

If the handset is off the base unit, press **TALK**.

- You can also answer a call by pressing any dialing button **0** to **9**, ***** or **#** (—Any Key Talk).

OR

If on the base unit, just lift up.

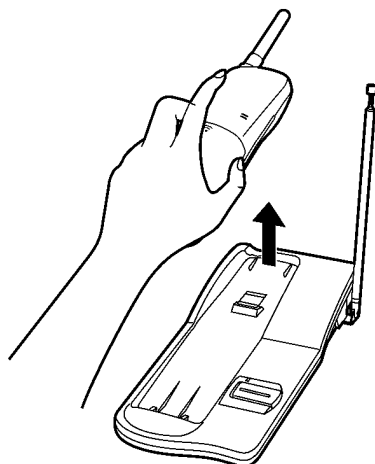

Selecting the ringer volume

The TALK indicator light must be off.

- To select **HIGH** (preset) or **LOW**, press **RINGER**.
Each time you press the button, the ringer volume will change and the selected volume will ring.
- To turn the ringer **OFF**, press and hold **RINGER** until a beep sounds.
- To turn the ringer **ON**, press **RINGER**.

5.3. Storing Phone Numbers in Memory

You can store up to 10 phone numbers in the handset. The dialing buttons (0) to (9) function as memory stations.

The TALK indicator light must be off before programming.

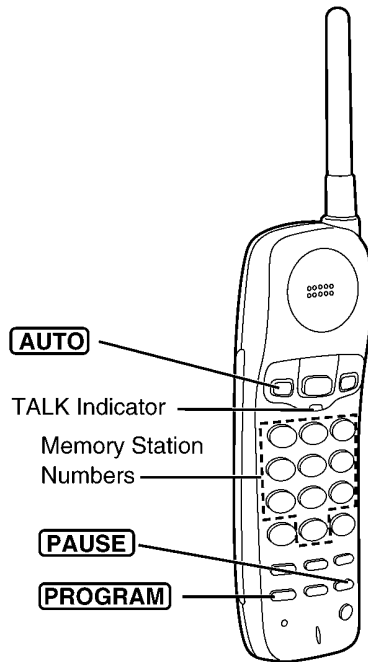

- 1 Press **PROGRAM**.
 - The TALK indicator flashes.
 - 2 Enter a phone number up to 16 digits.
 - 3 Press **AUTO**.
 - 4 Press a memory station number (0 to 9).
 - A beep sounds.
 - To store other numbers, repeat steps 1 through 4.
- To cancel during programming, press **PROGRAM**. Start from step 1.
 - If a pause is required for dialing, press **PAUSE** where needed. Pressing **PAUSE** counts as one digit.

To erase a stored number

Press **PROGRAM** ➔ **AUTO** ➔
 ➔ the memory station number (0 to 9)
 for the phone number to be erased.
 • A beep sounds.

5.4. Storing a Phone Number in the DIRECT Button

A phone number stored in the **DIRECT** button can be dialed with a one-touch operation.

The TALK indicator light must be off before programming.

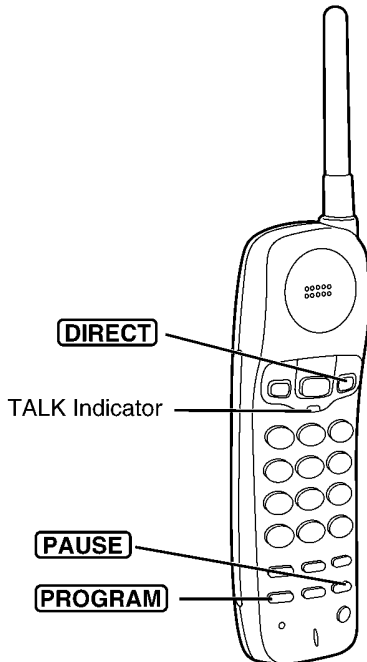

- 1 Press **PROGRAM**.
 - The TALK indicator flashes.
 - 2 Enter a phone number up to 16 digits.
 - 3 Press **DIRECT**.
 - A beep sounds.
- To cancel during programming, press **PROGRAM**. Start from step 1.
 - If a pause is required for dialing, press **PAUSE** where needed. Pressing **PAUSE** counts as one digit.

To erase a stored number

Press **PROGRAM** ➔ **DIRECT**.
 • A beep sounds.

5.5. Dialing a Stored Number

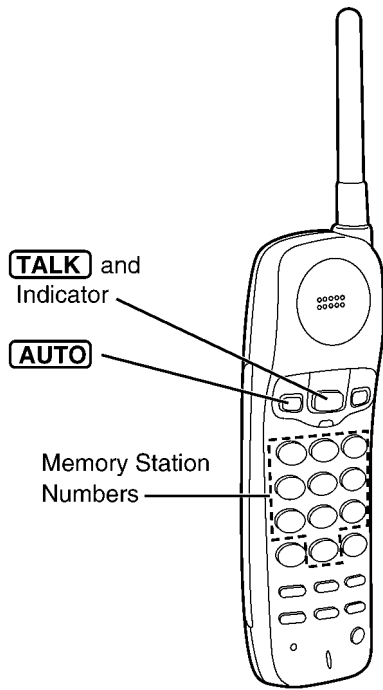

- 1 Press **TALK**.
 - The TALK indicator lights.
- 2 Press **AUTO**.
- 3 Press the memory station number (**0** to **9**).
 - The stored number is dialed.

5.6. Dialing a Stored Number in the DIRECT Button

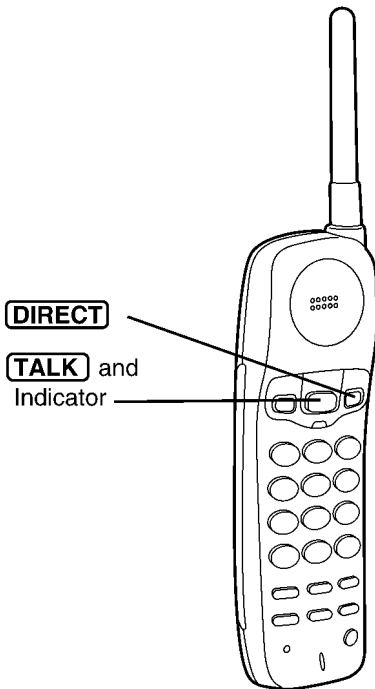

- 1 Press **TALK**.
 - The TALK indicator lights.
- 2 Press **DIRECT**.
 - The stored number is dialed.

5.7. FLASH Button

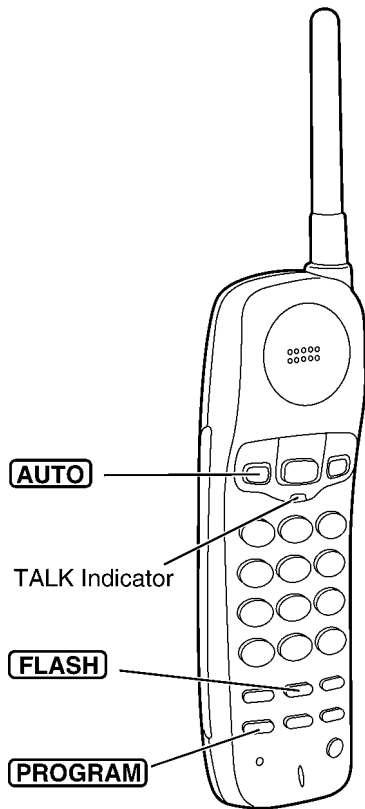

Pressing **FLASH** allows you to use special features of your host PBX such as transferring an extension call or accessing special telephone services (optional), such as call waiting.

Selecting the flash time

The flash time depends on your telephone exchange or host PBX. You can select the following flash times; "90, 100, 110, 250, 300, 400, 600 or 700 msec (milliseconds)". Your phone comes from the factory set to "700 msec".

The TALK indicator light must be off before programming.

Press **PROGRAM** ➡ **Dialing button (1 to 8)** ➡ **AUTO** ➡ **FLASH** .

1 : 90 msec	2 : 100 msec	3 : 110 msec
4 : 250 msec	5 : 300 msec	6 : 400 msec
7 : 600 msec	8 : 700 msec	

- A beep sounds.
- If 3 beeps sound after programming, a wrong key was pressed. Start again from the beginning.
- If you are connected via a PBX, a longer flash time may be necessary to use PBX functions (transferring a call etc.). Consult your PBX supplier for the correct setting.

6 DISASSEMBLY INSTRUCTIONS

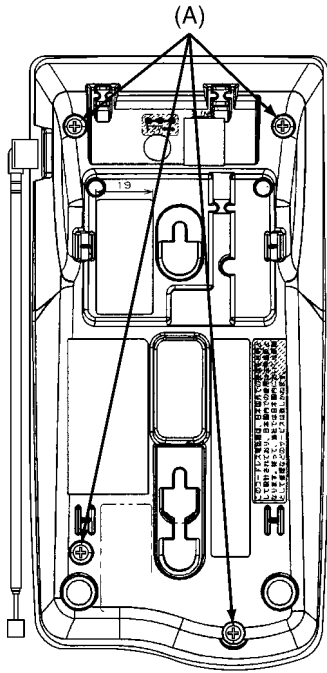
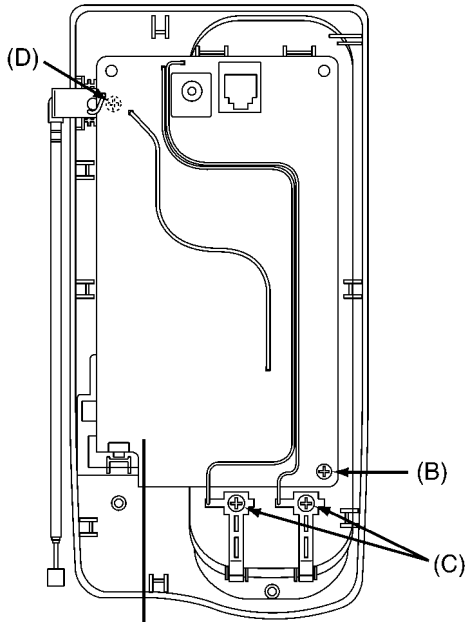

Fig. 1



Remove the P.C.Board.

Fig. 2

Show in Fig.	To remove.	Remove.
1	Lower Cabinet	Screws (2.6 x 12)..... (A) x 4
2	Main P.C. Board	Screws (2.6 x 6)..... (B) x 1
		Screws (2.6 x 6).....(C) x 2
		Screws (2.6 x 12).....(D) x 1
		Main P.C. Board.

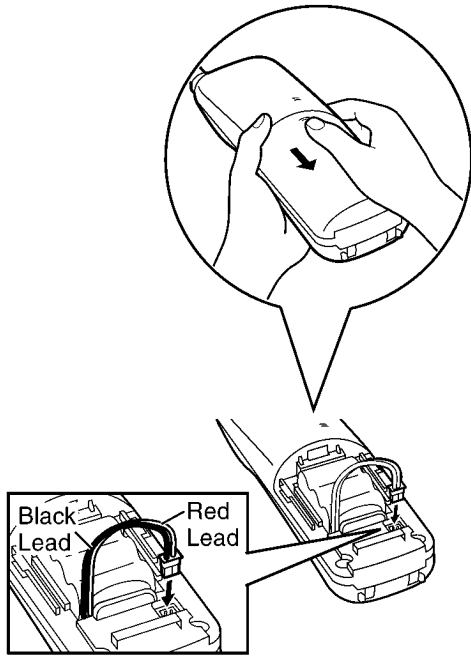

Fig. 3

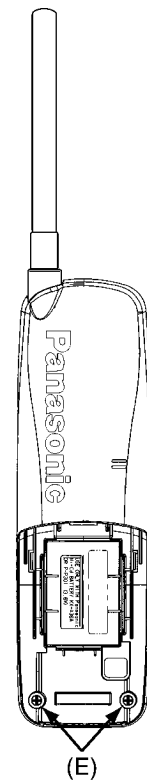

Fig. 4

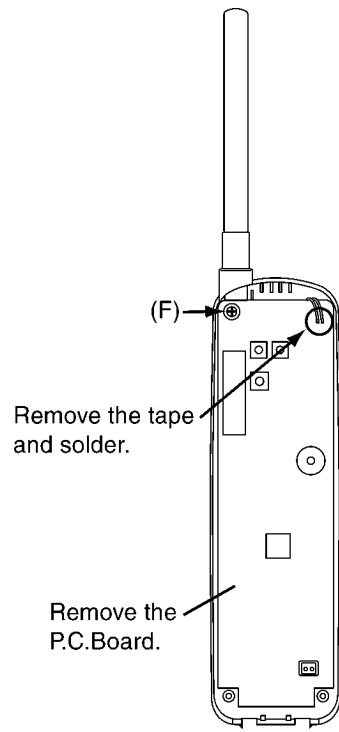

Fig. 6

Note: When opening the upper cabinet, be careful of the speaker lead wire.

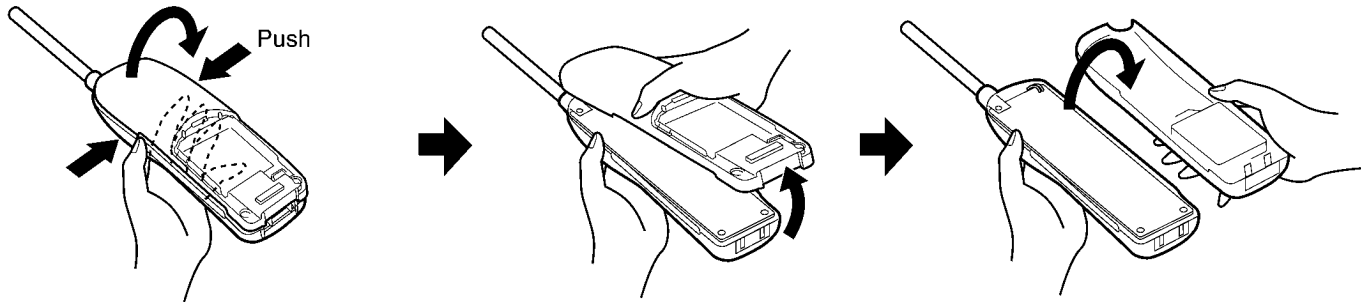
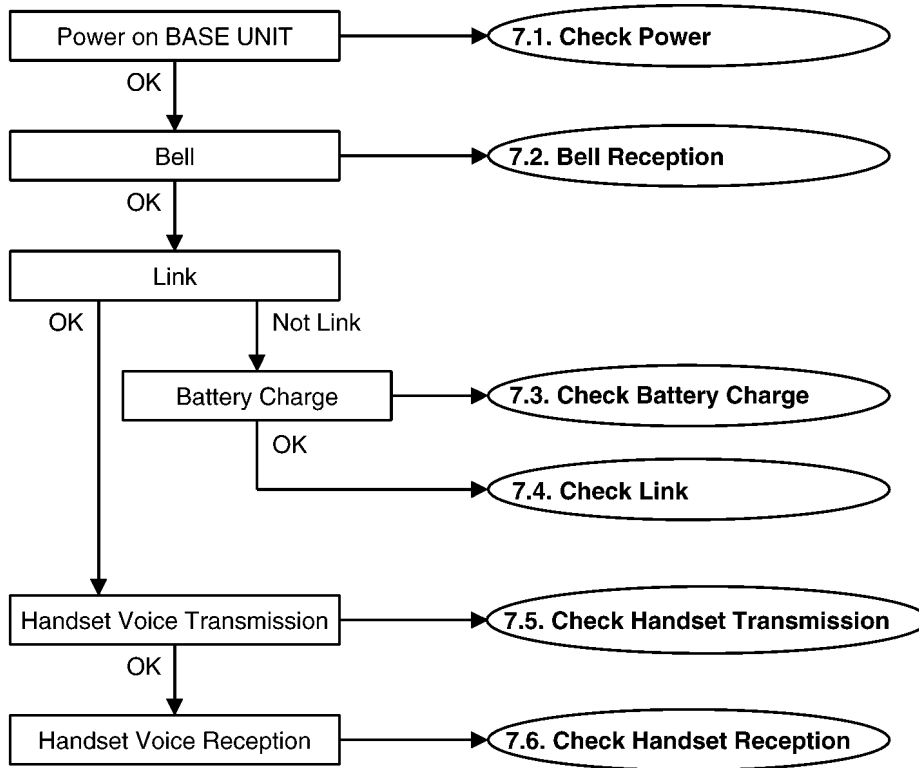

Fig. 5

Show in Fig.	To remove.	Remove.
3	Rear Cabinet	Battery compartment cover.
4		Screws (2.6 x 12).....(E) x 2
5	Main P. C. Board	Screw (2.6 x 12).....(F) x 1
		Tape and solder.
		Main P. C. Board.

7 TROUBLESHOOTING GUIDE

MAIN



Cross Reference:

Check Power (P.17)

Bell Reception (P.18)

Check Battery Charge (P.19)

Check Link (P.20)

Check Handset Transmission (P.22)

Check Handset Reception (P.22)

7.1. Check Power

Base Unit

Is the AC Adaptor inserted into 230V outlet?
(AC Adaptor PQLV16CEZ)

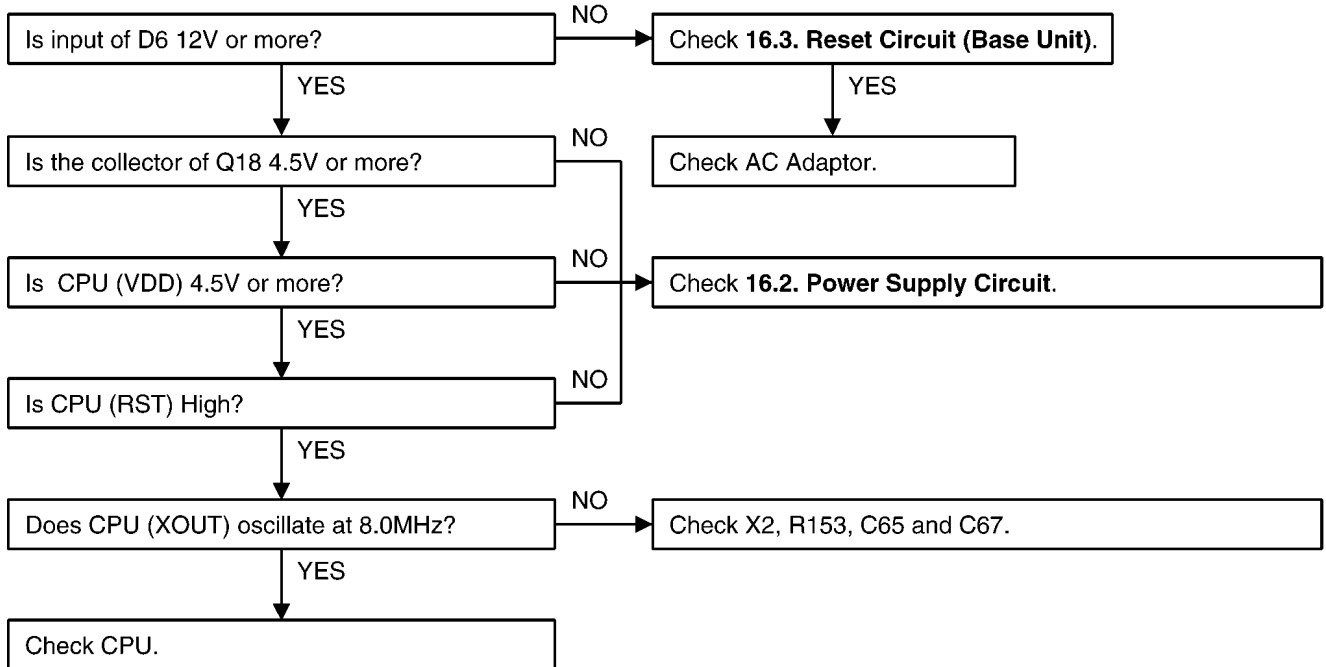

Cross Reference:

Reset Circuit (Base Unit) (P.40)

Power Supply Circuit (P.39)

Note:

CPU: IC2

HANDSET

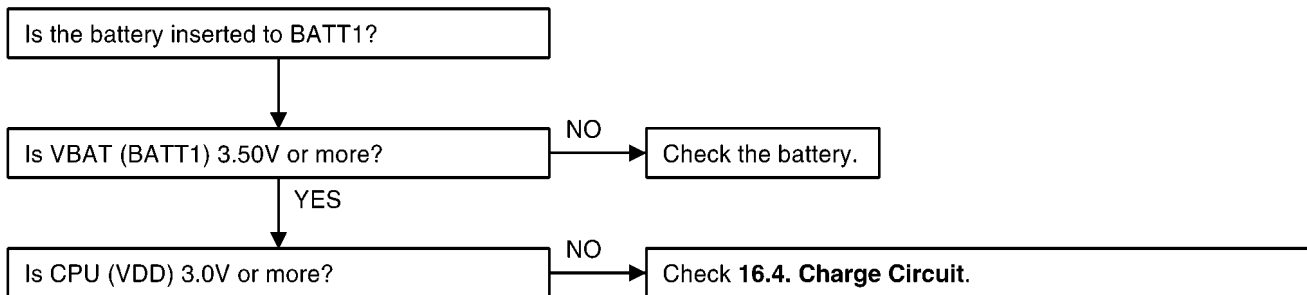

Cross Reference:

Charge Circuit (P.41)

Note:

CPU: IC2

*: Each measurement points are shown in **CIRCUIT BOARD (Base Unit)** (P.65) or **CIRCUIT BOARD (Handset)** (P.67)

7.2. Bell Reception

Base Unit

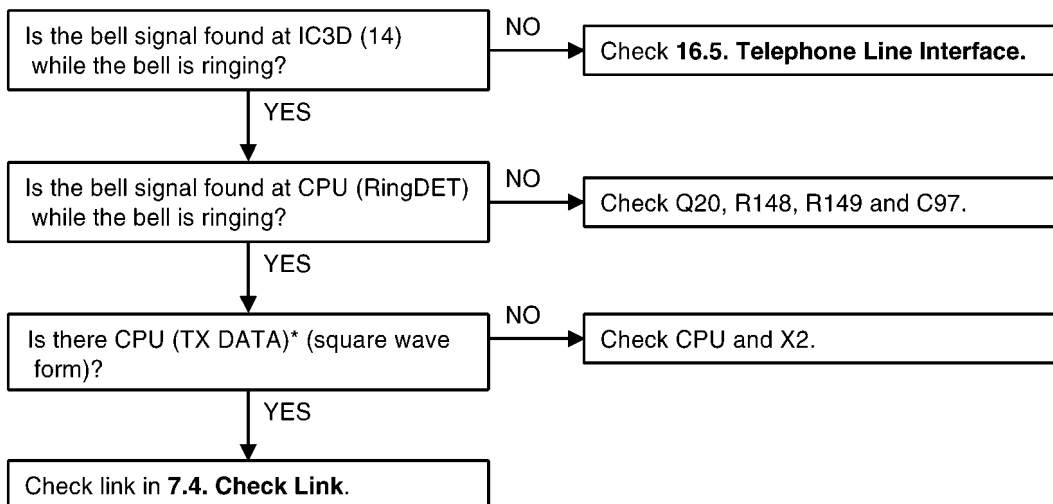

Cross Reference:

Check Link (P.20)

Telephone Line Interface (P.41)

Note:

CPU: IC2

HANDSET

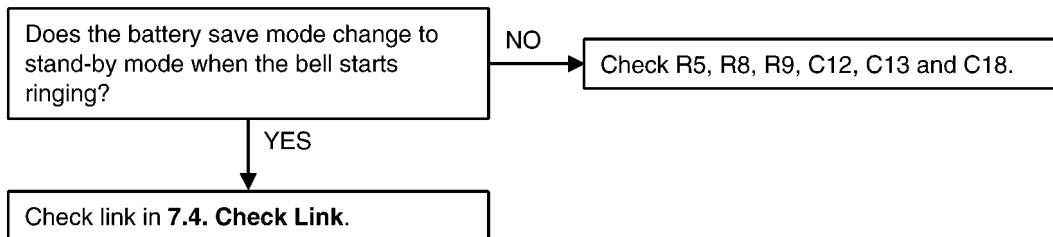

Cross Reference:

Check Link (P.20)

*: Each measurement points are shown in **CIRCUIT BOARD (Base Unit)** (P.65) or **CIRCUIT BOARD (Handset)** (P.67)

7.3. Check Battery Charge

Base Unit

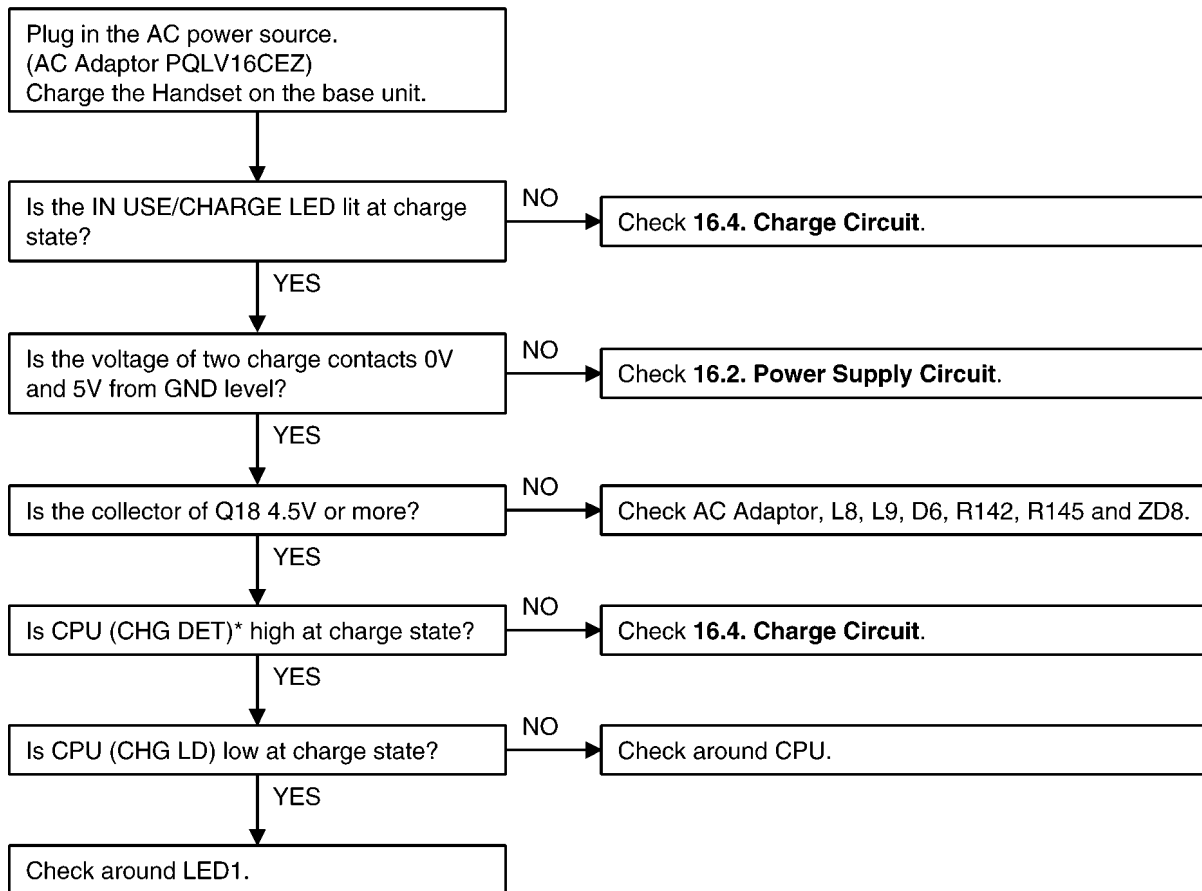

Cross Reference:

Charge Circuit (P.41)

Power Supply Circuit (P.39)

Note:

CPU: IC2

HANDSET

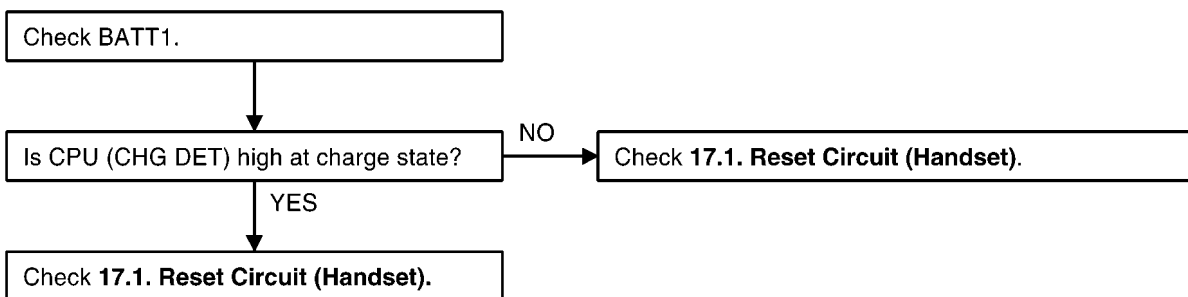

Cross Reference:

Reset Circuit (Handset) (P.45)

Note:

CPU: IC2

*: Each measurement points are shown in **CIRCUIT BOARD (Base Unit)** (P.65) or **CIRCUIT BOARD (Handset)** (P.67)

7.4. Check Link

BASE UNIT

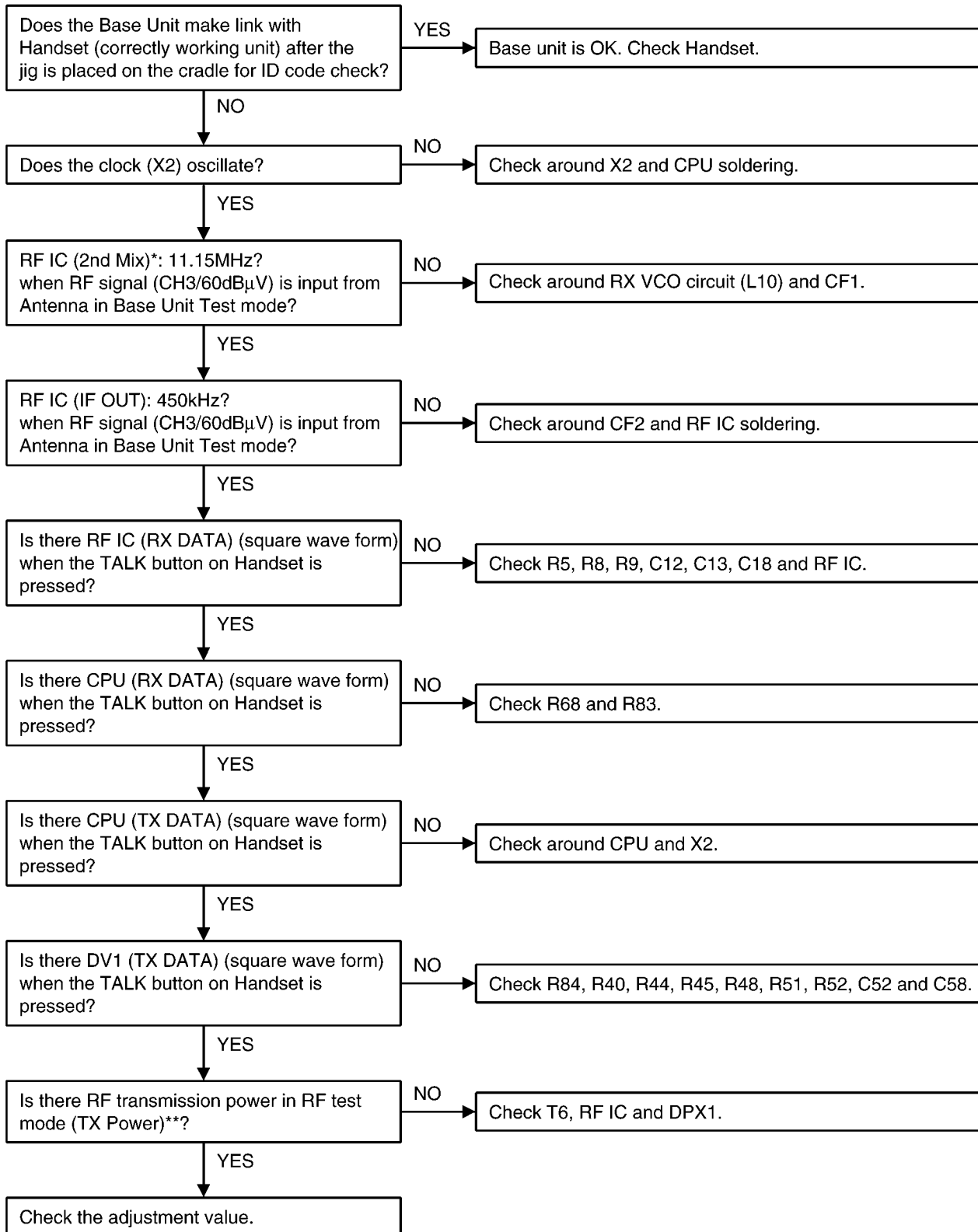

** : Refer to **Adjustment** (P.24)

Note:

CPU: IC2

RF IC: IC1

* : Each measurement points are shown in **CIRCUIT BOARD (Base Unit)** (P.65) or **CIRCUIT BOARD (Handset)** (P.67)

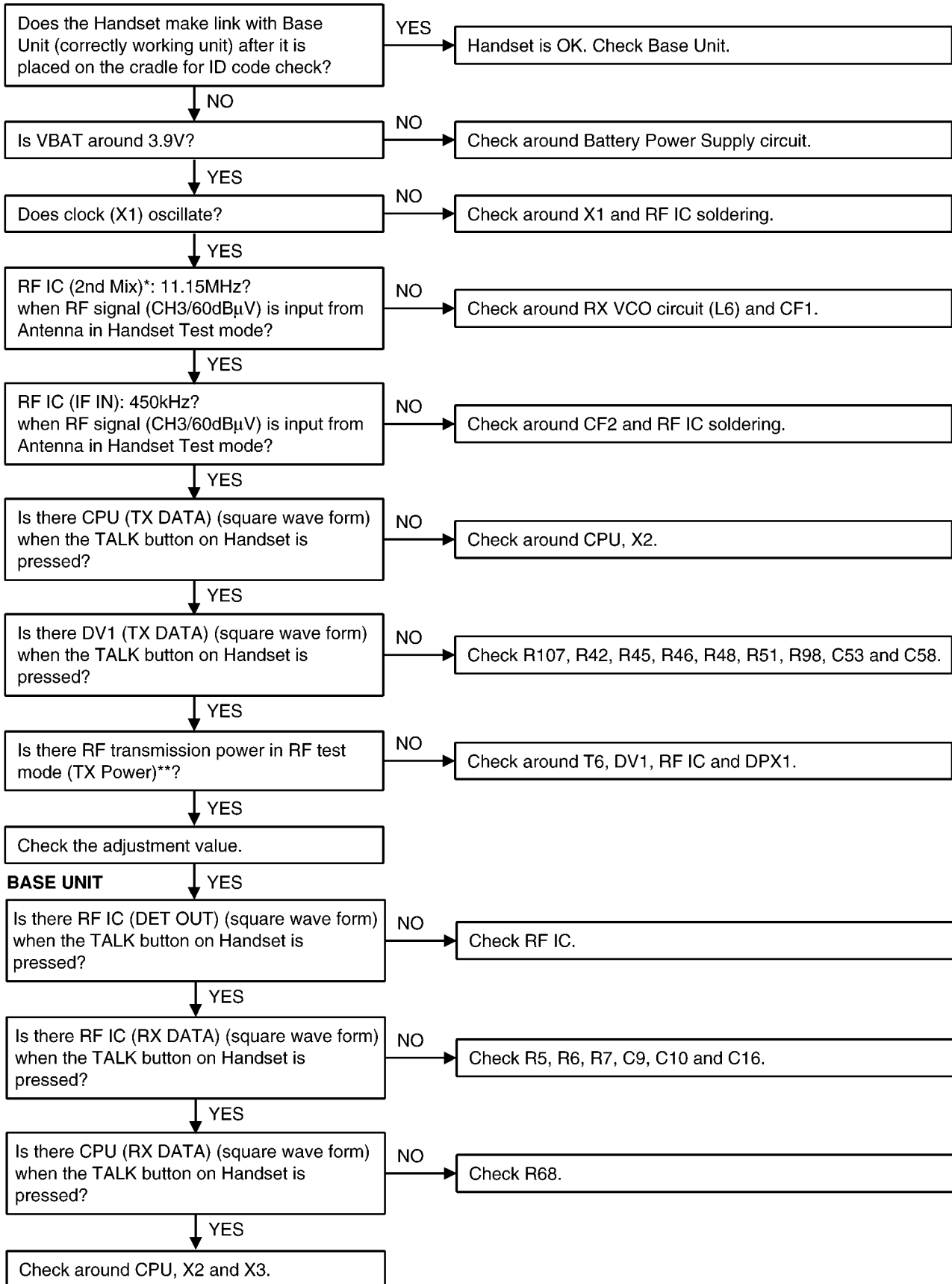
HANDSET

** : Refer to **Adjustment** (P.27).

Note:

CPU: IC2

RF IC: IC1

* : Each measurement points are shown in **CIRCUIT BOARD (Base Unit)** (P.65) or **CIRCUIT BOARD (Handset)** (P.67)

7.5. Check Handset Transmission

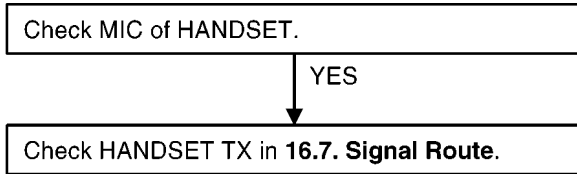

Cross Reference:

Signal Route (P.44)

7.6. Check Handset Reception

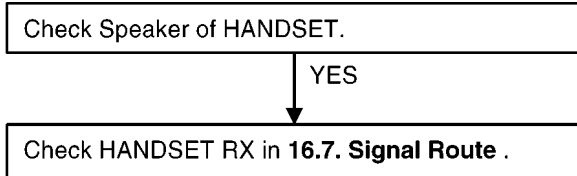

Cross Reference:

Signal Route (P.44)

*: Each measurement points are shown in **CIRCUIT BOARD (Base Unit)** (P.65) or **CIRCUIT BOARD (Handset)** (P.67)

8 ADJUSTMENTS (BASE UNIT)

If your unit have below symptoms, adjust or confirm each item using remedy column from the table.

Symptom	Remedy*
The base unit dose not respond to a call from handset.	Make adjustments in item (A)
The base unit dose not transmit or the transmit frequency is off.	Make adjustments in item (B)
The transmit frequency is off.	Make confirmation in item (C)
The transmit power outlet is low, and the operating distance between the base unit and the handset is less than normal.	Make confirmation in item (D)
The reception sensitivity of base unit is low with noise.	Make confirmation in item (E)
The transmit level is high or low.	Make confirmation in item (F)
The reception level is high or low.	Make adjustments in item (G)
The unit does not link.	Make confirmation in item (H)

*: Refer to **Adjustment** (P.24).

8.1. Test Mode Flow Chart (Base Unit)

The operation-flow of Test mode and main check items are shown below.

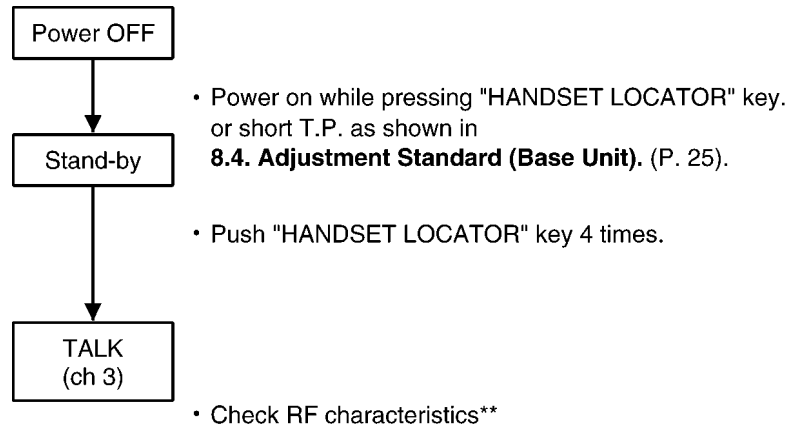

Note:

** : Refer to the above table.

8.2. How to change the channel

When short R98* shortly, the channel will be changed as follows;

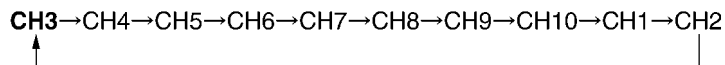

*: Refer to **Flow Solder Side View** (P.66).

8.3. Adjustment

	Adjustment Items	Test Mode	Adjustment Point	*Procedure	Check or Replace Parts
(A)	RX VCO Confirmation	3ch Talk	-	• Confirm so that the reading of the Digital Voltmeter is $1.5V \pm 0.5V$.	IC1, L10, C26
(B)	TX VCO Adjustment	3ch Talk	T6	• Adjust T6 so that the reading of the Digital Voltmeter is $2.0V \pm 0.1V$.	IC1, DV1, T6
(C)	TX Frequency Adjustment	3ch Talk	VC1	• Adjust VC1 so that the reading of the frequency counter is $30.175MHz \pm 0.1KHz$.	IC1, X1, T6, DV1, C35, C40, VC1
(D)	TX Power Adjustment	3ch Talk	T5	• Adjust T5 so that the reading of the RF VTVM is over 10dBm.	IC1, Q3, Q4, Q5, T5, DPX1
(E)	RX Sensitivity Adjustment (2nd IF output)	3ch Talk	T2	1. Apply -60dBm output from S.S.G. (modulation frequency 1KHz, dev. 0KHz). 2. Adjust T2 so that the reading of RF VTVM is the maximum value (more than 20mV)	DPX1, T2, CF1, CF2
(F)	Line Output Level Confirmation	3ch Talk	-	1. Apply -60dBm output from S.S.G. (modulation frequency 1KHz, dev. 3KHz). 2. Confirm that the reading of AF VTVM is $80mV \pm 20mV$ (600Ω load).	IC1, Q11
(G)	Line Input Modulation Confirmation	3ch Talk	-	1. Input via loop simulator 1.0KHz, 80mV (measured at T-R) signal. 2. Apply -60dBm output from S.S.G. (modulation frequency 1KHz, dev. 0KHz). 3. Confirm so that the reading of FM Deviation Meter is $2.8KHz \pm 0.3KHz$.	IC1, DV1
(H)	Noise Squelch Confirmation	3ch Talk	-	1. Measure the SSG output level when the noise squelch changes from Low to High. 2. Confirm so that the SSG output level is -105dBm ~ -110dBm.	IC1, DPX1

* : The connection of adjustment equipment are as shown in **Adjustment Standard (Base Unit)** (P.25).

SSG Frequency: 39.875 MHz

8.4. Adjustment Standard (Base Unit)

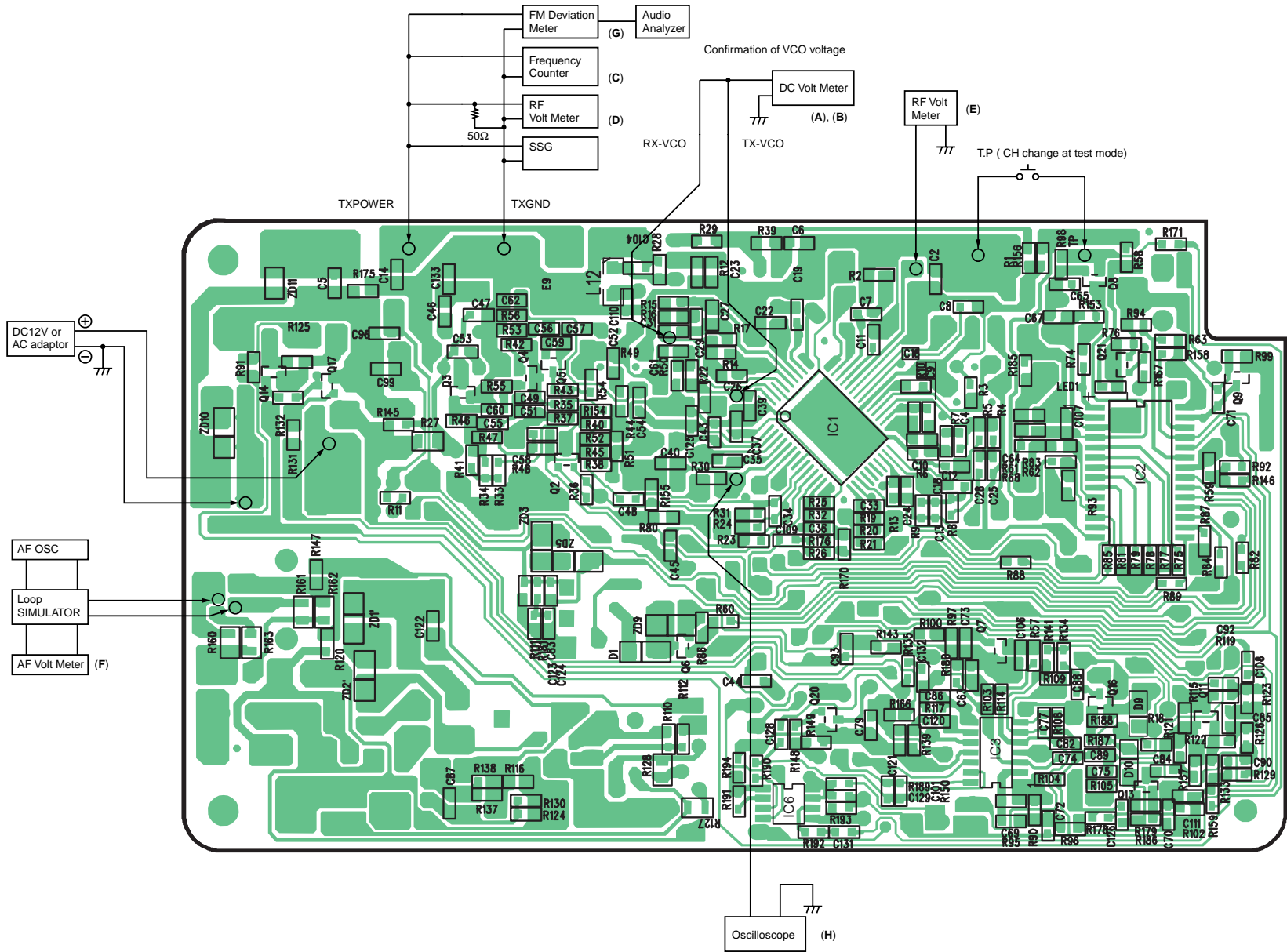

Note: (A) - (H) is referred to **ADJUSTMENTS (BASE UNIT)** (P.23)

9 ADJUSTMENTS (HANDSET)

If your unit have below symptoms, adjust or confirm each item using remedy column from the table.

Symptom	Remedy*
The movement of Battery Low Indicator is wrong.	Make confirmation in item (A)
The base unit does not respond to a call from the handset.	Make adjustments in item (B)
The base unit does not transmit or the transmit frequency is off.	Make adjustments in item (C)
The transmit frequency is off.	Make confirmation in item (D)
The transmit power outlet is low, and the operating distance between the base unit and the handset is less than normal.	Make confirmation in item (E)
The reception sensitivity of base unit is low with noise.	Make confirmation item (F)
Does not link between the base unit and the handset.	Make confirmation in item (G)
The reception level is high or low.	Make confirmation item (H)
The transmit level is high or low.	Make adjustments in item (I)

*: Refer to **Adjustment (P.27)**.

Unit condition:

1. Remove the antenna lead wire from P.C Board of the handset.
2. Power Supply: DC 3.9V (DC power supply)
3. Volume: HIGH (When P.C. Board of handset is in test mode, volume condition is medium. Press "LOCATOR" key once.)
4. Speaker Load: 150Ω

CH	TX Frequency	RX Frequency
CH3	39.875MHz	30.175MHz

9.1. Test Mode Flow Chart (Handset)

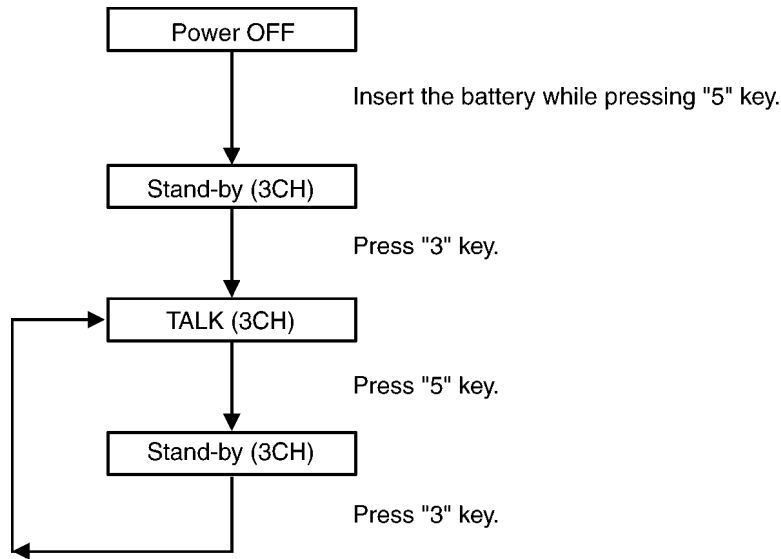

Note:

Refet to **CIRCUIT BOARD (Handset) (P.67)**

Signal Route (P.44)

9.2. How to change the channel

- Press **[*]** button.

CH3 → CH4 → CH5 → CH6 → CH7 → CH8 → CH9 → CH10 → CH1 → CH2

- Press **[#]** button.

CH3 → CH2 → CH1 → CH10 → CH9 → CH8 → CH7 → CH6 → CH5 → CH4

9.3. Adjustment

	Adjustment Items	Test Mode	Adjustment Point	Procedure	Check or Replace Parts
(A)	Battery Low Confirmation	3ch Talk	-	<ol style="list-style-type: none"> 1. Set the power supply voltage to DC3.60V, and confirm so that the reading of oscilloscope is High. 2. Set the power supply voltage to DC 3.40V, and confirm so that the reading of oscilloscope is Low. 	IC1
(B)	TX VCO Voltage	3ch Talk	T6	<ol style="list-style-type: none"> 1. Adjust T6 so that the reading of the Digital Voltmeter is $1.0V \pm 0.1V$. 	IC1, X1, T6
(C)	RX VCO Confirmation	3ch Talk	-	<ul style="list-style-type: none"> • Confirm RX VCO voltage so that the reading of the Digital Voltmeter is $2.9V \pm 0.5V$. 	IC1, X1, T6, L6, C24
(D)	TX Frequency Adjustment	3ch Talk	VC1	<ul style="list-style-type: none"> • Adjust VC1 so that the reading of the frequency counter is $39.875MHz \pm 0.1KHz$. 	IC1, VC1, DPX1, T5
(E)	TX Power Adjustment	3ch Talk	T5	<ul style="list-style-type: none"> • Adjust T5 so that the reading of the RF VTVM (50Ω load) is $5dBm \pm 1dBm$. 	DPX1, Q5, T5
(F)	RX Sensitivity Adjustment (2nd IF output)	3ch Talk	T3	<ol style="list-style-type: none"> 1. Apply -60dBm output from S.S.G. (modulation frequency 1KHz, dev. 0KHz). 2. Adjust T3 so that the reading of RF VTVM is more than 15mV. 	DPX1, T3, IC1, CF1, CF2
(G)	Noise Squelch Confirmation	3ch Talk	-	<ol style="list-style-type: none"> 1. Measure the SSG output level when the noise squelch changes from Low to High. (modulation frequency 1KHz, dev. 3kHz) 2. Confirm so that the SSG output level is -105dBm. 	IC1, DPX1
(H)	Speaker Output Level confirmation	3ch Talk	-	<ol style="list-style-type: none"> 1. Apply -60dBm output from S.S.G. (modulation frequency 1KHz, dev. 3KHz). 2. Confirm so that SP output level is $120mV \pm 30mV$. (distortion: less than 7%) (volume High). 	IC1
(I)	Mic Modulation Factor Confirmation	3ch Talk	-	<ol style="list-style-type: none"> 1. Apply a MIC signal (1KHz, 2.4mV at 600Ω load). 2. Confirm so that the reading FM Deviation Meter is $3.1KHz \pm 0.4KHz$. 	IC1, DV1
(J)	Data Modulation Confirmation	3ch Talk	-	<ul style="list-style-type: none"> • Confirm so that the reading of the FM Deviation Meter is $5kHz \pm 1kHz$. 	

The connections of adjustment equipment are as shown in **Adjustment Standard (Handset)** (P.28).

SSG Frequency: 30.175 MHz

9.4. Adjustment Standard (Handset)

(Component View)

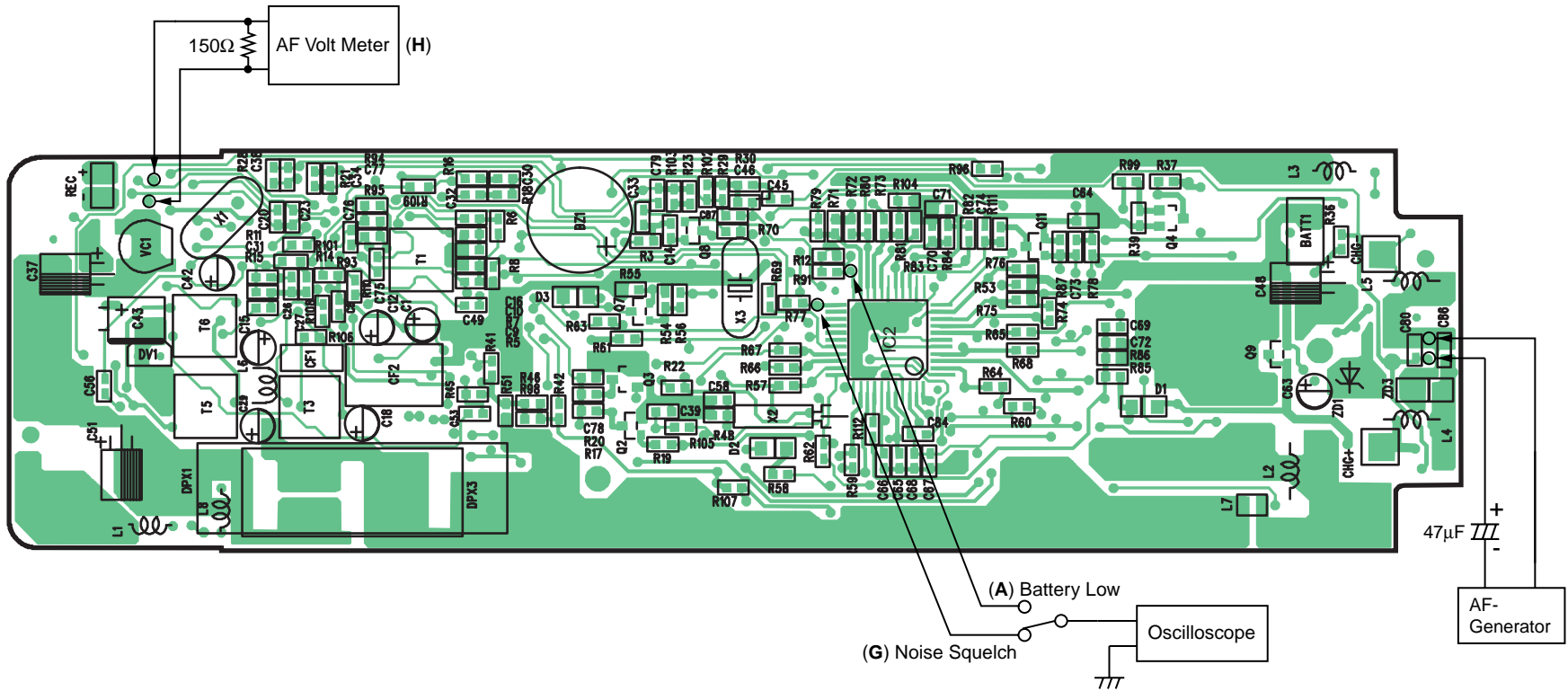

Note: (A) - (I) is referred to **ADJUSTMENTS (HANDSET)** (P.26)

(Flow Solder Side View)

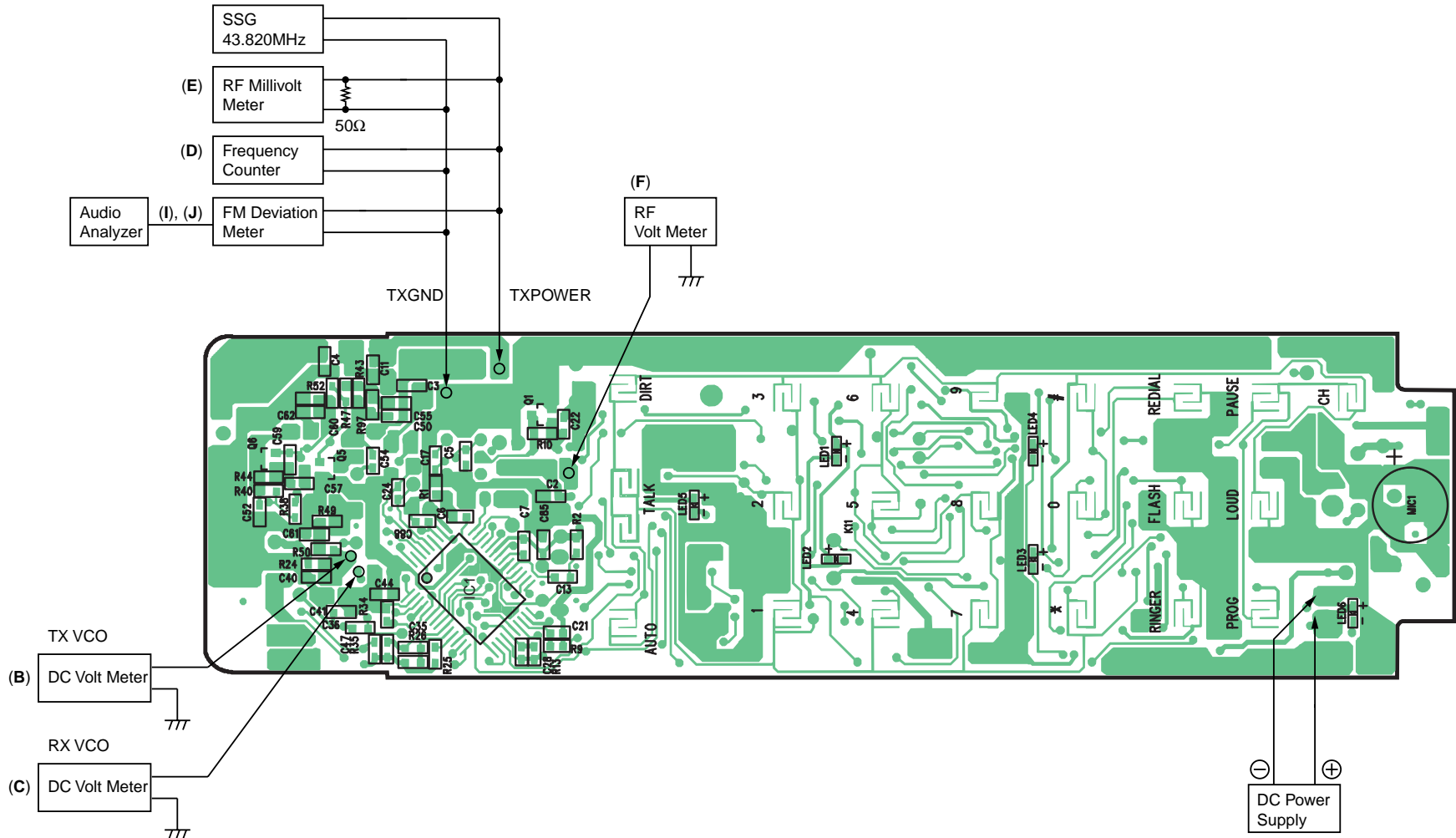

Note: (A) - (I) is referred to **ADJUSTMENTS (HANDSET)** (P.26)

10 RF SPECIFICATION

10.1. Base Unit

Item	Value	Refer to -.*	Remarks
TX Frequency	30.175 MHz \pm 0.1kHz	ADJUSTMENTS (BASE UNIT) (C)	at CH3
TX Power	8mW (3CH)	ADJUSTMENTS (BASE UNIT) (D)	at CH3
Line Modulation factor	2.8 kHz~3.4 kHz	ADJUSTMENTS (BASE UNIT) (G)	
Line Modulation factor (Max.)	4.5 kHz~8.5 kHz	—	
Data Modulation factor	3 kHz~7 kHz	—	
Line Output level	80mV \pm 20mV	—	

*: Refer to **Adjustment** (P.24).

10.2. Handset

Item	Value	Refer to -.**	Remarks
TX Frequency	39.875 MHz \pm 0.1kHz	ADJUSTMENTS (HANDSET) (D)	at CH3
TX Power	4mW (3CH)	ADJUSTMENTS (HANDSET) (E)	at CH3 (Antenna soldering point 50 Ω Load)
Data Modulation factor	4.0 kHz/dev~8.0 kHz/dev	ADJUSTMENTS (HANDSET) (J)	at CH3
MIC Modulation factor	1.5 kHz/dev~0.3 kHz/dev	ADJUSTMENTS (HANDSET) (I)	at CH3 (MIC terminal 2.4mV Input)
SP Output level	120mV \pm 30mV	—	

** : Refer to **Adjustment** (P.27).

11 HOW TO CHECK THE HANDSET SPEAKER

1. Prepare the digital voltmeter, and set the selector knob to ohm meter.
2. Put the probes at the speaker terminals as shown below.

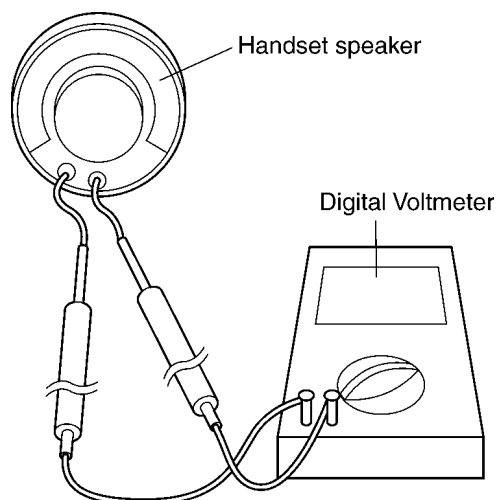
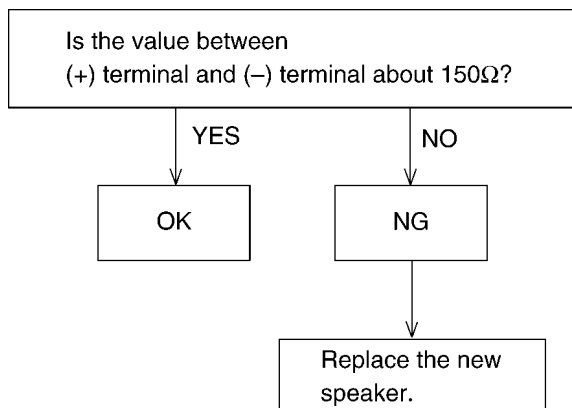

12 FREQUENCY TABLE (MHz)

Channel	BASE UNIT		PORTABLE UNIT	
	Transmit Frequency	Receive Frequency	Transmit Frequency	Receive Frequency
1	30.0750	39.7750	39.7750	30.0750
2	30.1250	39.8250	39.8250	30.1250
3	30.1750	39.8750	39.8750	30.1750
4	30.2250	39.9250	39.9250	30.2250
5	30.2750	39.9750	39.9750	30.2750
6	30.1000	39.8000	39.8000	30.1000
7	30.1500	39.8500	39.8500	30.1500
8	30.2000	39.9000	39.9000	30.2000
9	30.2500	39.9500	39.9500	30.2500
10	30.3000	40.0000	40.0000	30.3000

13 EXPLANATION OF CPU DATA COMMUNICATION

13.1. STAND-BY -> TALK, TALK -> STAND-BY

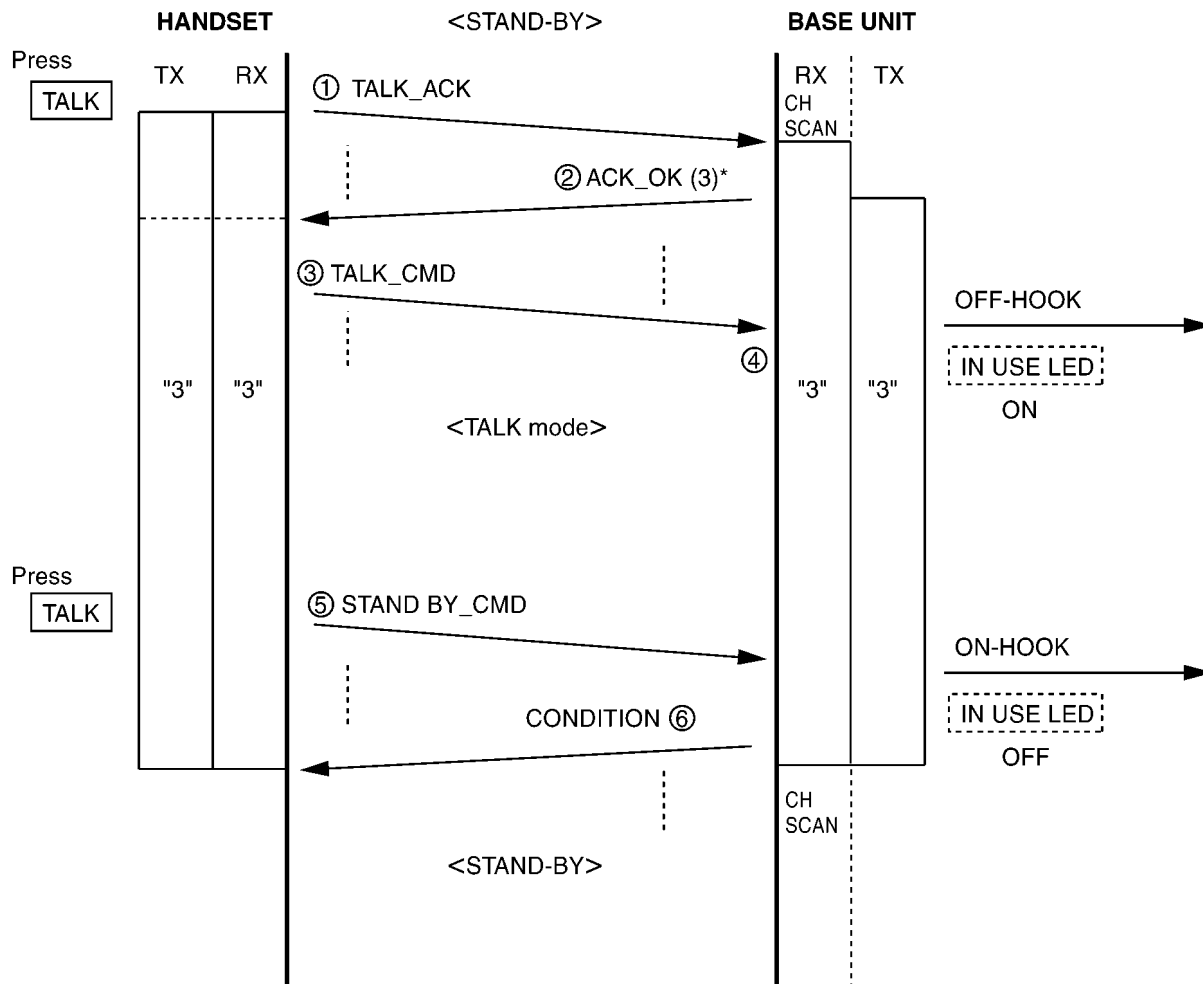

Press the TALK button

- ① The handset transmits TALK_ACK.
- ② Then base unit transmits ACK_OK including the channel number (Example: "3").
- ③ The handset transmits TALK_CMD.
- ④ The base unit goes to off-Hook mode.

Press the TALK button

- ⑤ The handset transmits STANDBY_CMD at the channel.
- ⑥ The base unit transmits CONDITION at the TALK channel.

*: The channel is changed if the noise interferes with the conversation.

13.2. Ringing

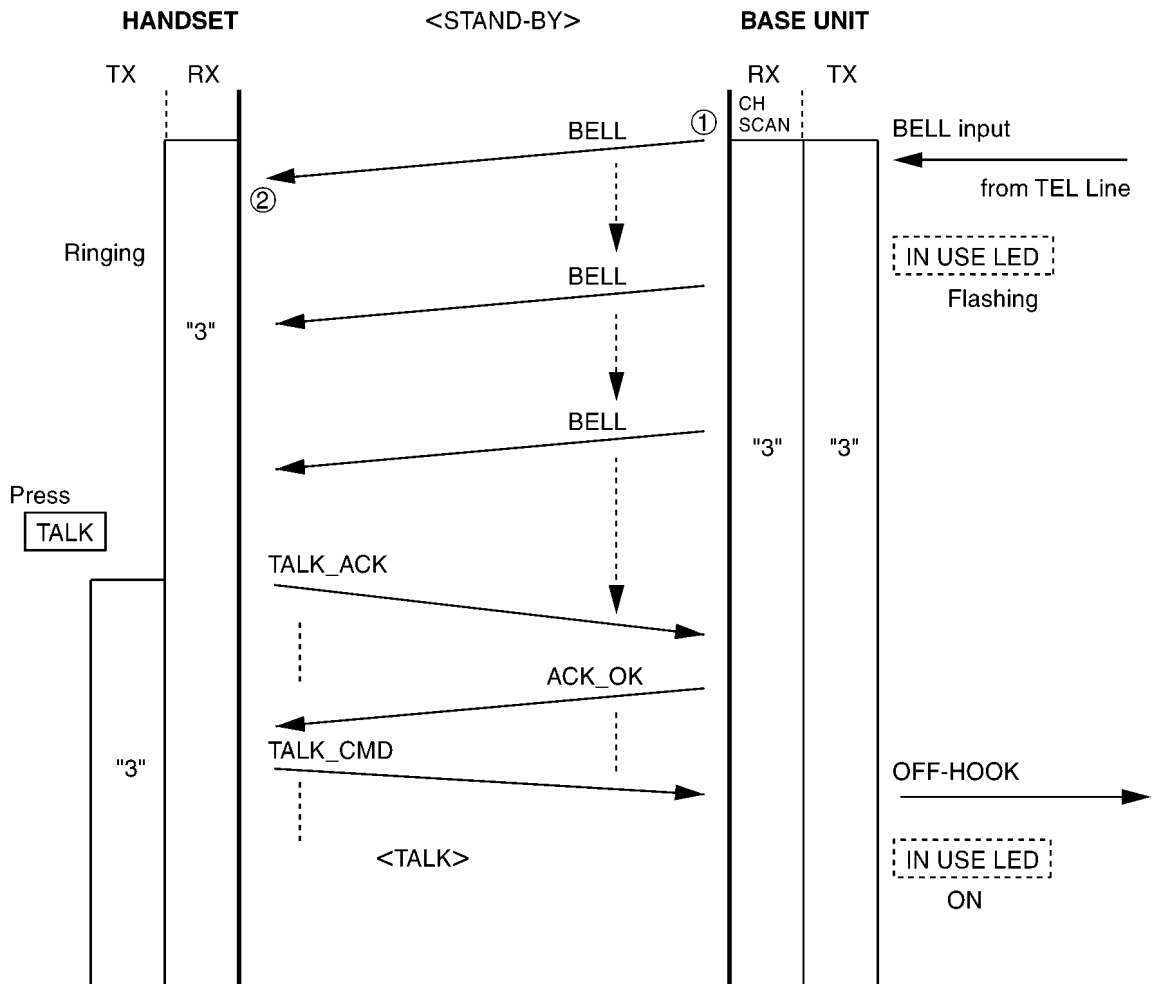

- ① When the bell signal is input, the base unit transmits BELL.
- ② The handset rings the bell on receiving BELL.

13.3. Changing the Channel

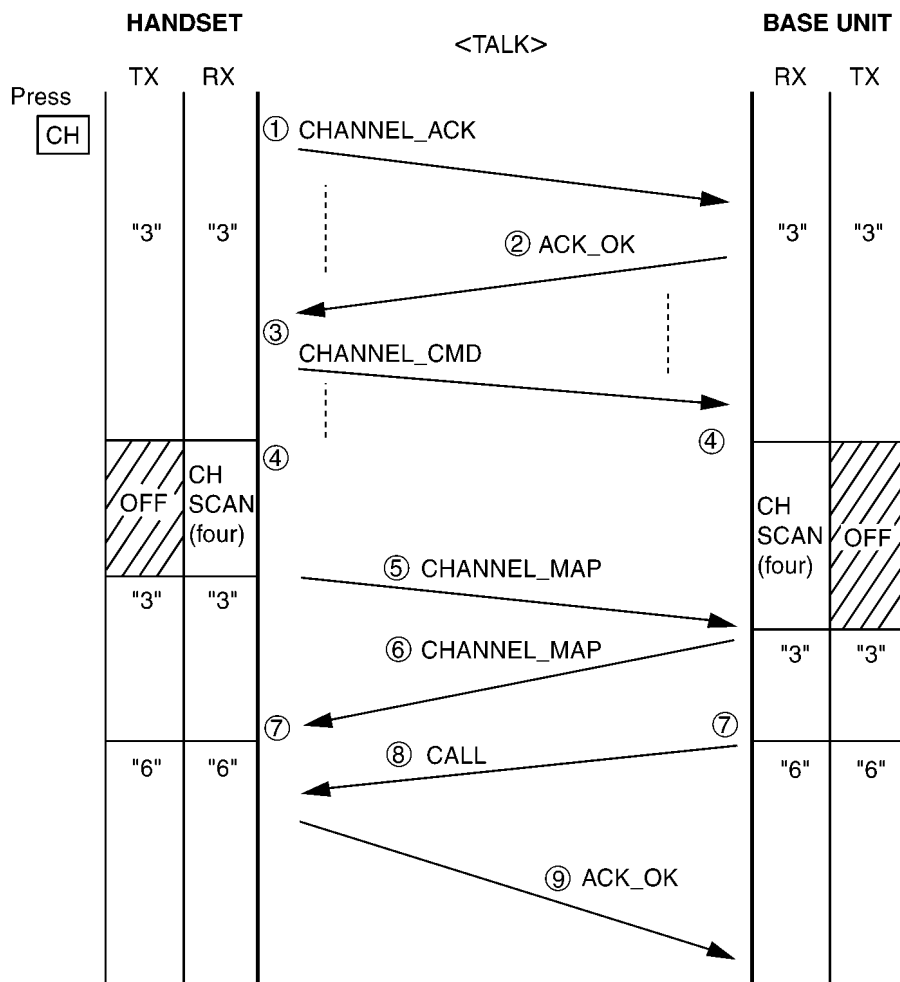

Press the **CH** button.

- ① The handset transmits CHANNEL_ACK.
- ② The base unit replies with ACK_OK.
- ③ Then handset transmits CHANNEL_CMD.
- ④ The handset and base unit turn off tx power and scan the channel map for next four channel.
- ⑤ The handset transmits CHANNEL_MAP.
- ⑥ The base unit transmits CHANNEL_MAP.
- ⑦ The handset and base unit moves to the "vacant channel". (Example: "6").
- ⑧ The base unit transmits CALL.
- ⑨ The handset transmits ACK_OK.

13.4. Ports for transmitting and receiving of data

Handset:
 transmitting (TX) ... 36 Pin
 receiving (RX) ... 4 Pin

Base Unit:
 transmitting (TX) ... 17 Pin
 receiving (RX) ... 10 Pin

13.5. Waveform of DATA used for cordless transmission and reception

The DATA which is transmitted from the Handset to the Base Unit is combination of DATA 0, DATA 1, PSEUD.

The DATA which is transmitted from the Base Unit to the Handset is combination of DATA 0, DATA 1, PSEUD.

13.5.1. Handset

Transmitting DATA Element Format

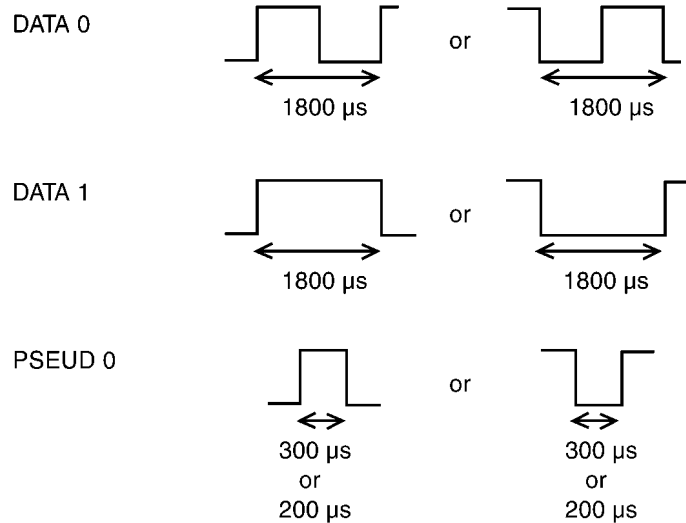

13.5.2. Base Unit

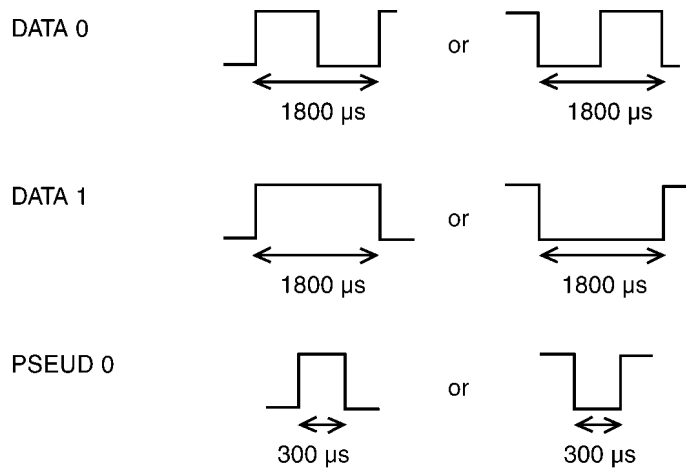

- For example (one of part of data)

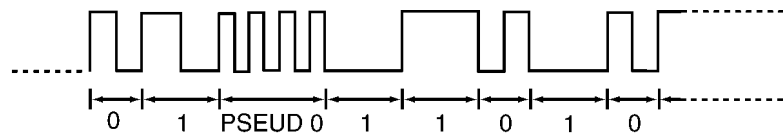

14 BLOCK DIAGRAM (BASE UNIT)

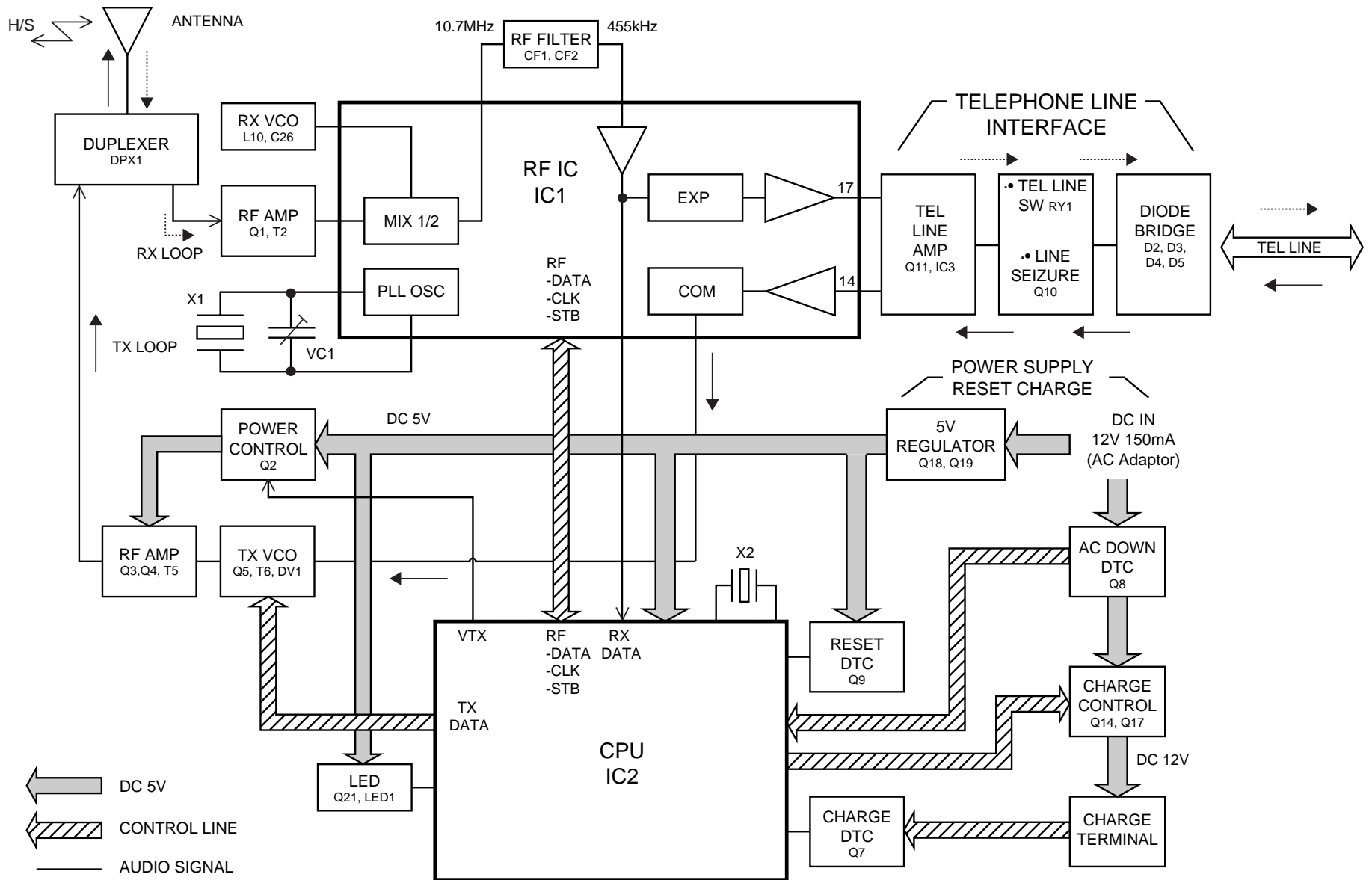

KX-TC1205RUB/W/S/F BLOCK DIAGRAM (BASE UNIT)

15 BLOCK DIAGRAM (HANDSET)

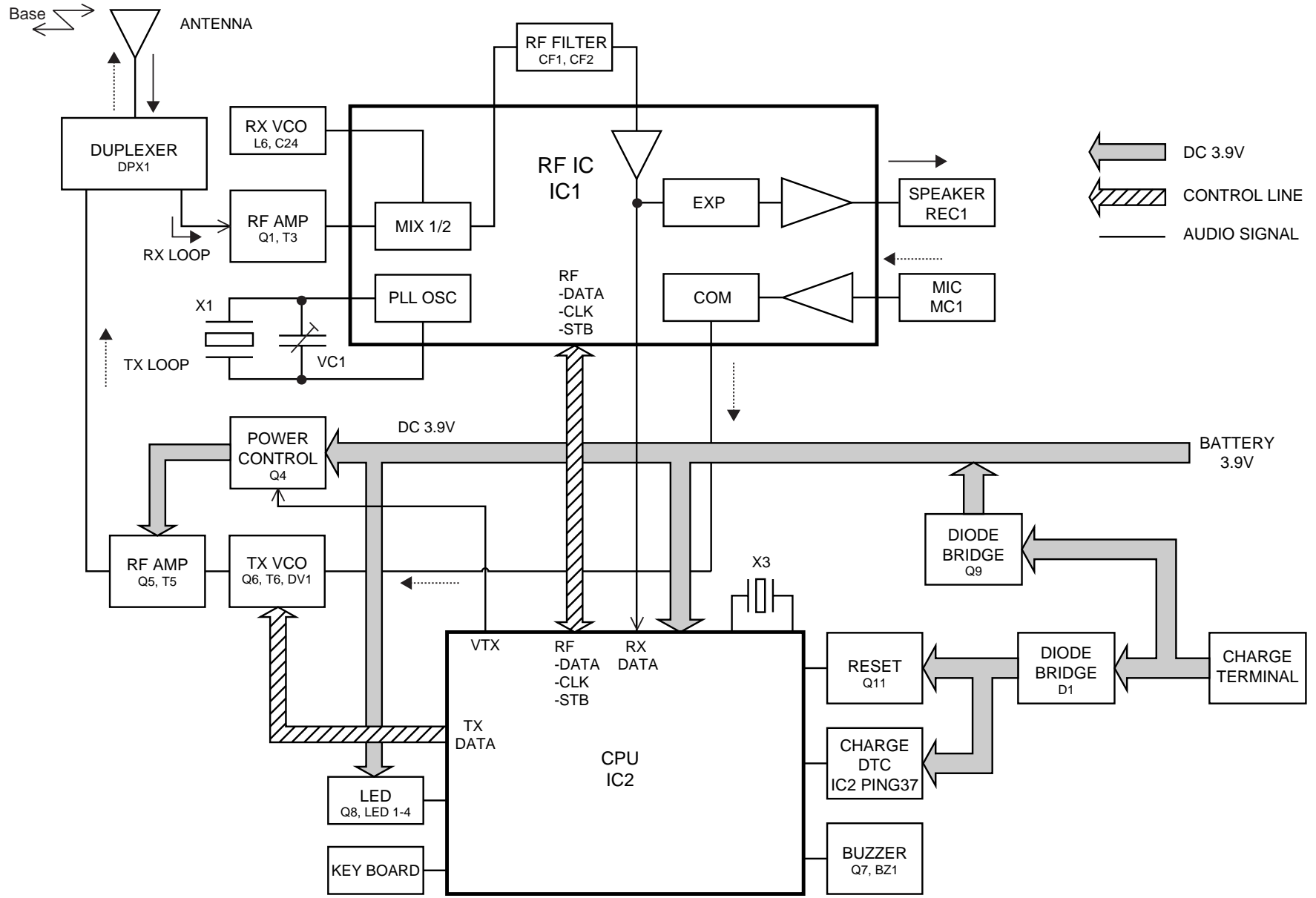

KX-TC1205RUB/W/S/F BLOCK DIAGRAM (HANDSET)

16 CIRCUIT OPERATION

16.1. Outline

Base unit consists of the following ICs as shown in BLOCK DIAGRAM.

- CPU:IC2
 - Controlling the whole system
 - Forming/analyzing all data signals (ACK, CMD signal etc.*)
 - All interfaces (ex: LED, KEY, SP, Mic, LCD, Detector Circuit (Charge/ Power Down))

*Refer to **EXPLANATION OF CPU DATA COMMUNICATION** (P.32).
- RF IC:IC1
 - PLL Oscillator
 - Detection
 - Compress/ Expander
 - first/ second mixer
 - Amplifier for transmission and reception
- Additionally,
 - Power Supply Circuit
 - Reset Circuit
 - Charge Circuit
 - Telephone Line Interface Circuit

Handset consist of the following ICs as shown in BLOCK DIAGRAM.

- CPU: IC2
 - All data signals (forming/analyzing ACK or CMD signal*)
 - All interfaces (ex; LED, Key, Buzzer, Detector Circuit, Charge, Battery Low)
 - RAM for keeping the data (CH Number, ID Code, etc.)
- RF IC:IC1
 - PLL Oscillator
 - Detector
 - Compress/Expander
 - first, second mixer
 - Amplifier for transmission and reception

*Refer to **EXPLANATION OF CPU DATA COMMUNICATION** (P.32).

16.2. Power Supply Circuit

The power supply to the CPU (Digital, Analog) and RF IC from AC Adaptor (+12V) is shown in the diagram below.

The base unit power supply is DC12V. The handset's power is supplied from 3.6V battery (Nickel-Cadmium battery) which is installed in the handset.

Power supply for transmitter is turned on by a press of "Talk" key on the handset. During the stand-by mode, the unit stops transmitting but receive the signal.

Also during on-hook condition (the handset is placed on the base unit), backup power for memory of the last dialed number is supplied through the battery (3.6V nickel-cadmium in the handset). The memory of this unit is not backed up by the current from the telephone line.

The base unit DC power supply is regulated by Q18, the CPU power is regulated by Q19. The Q8, detects AC Adaptor powerfailure and maintains the unit security cord;

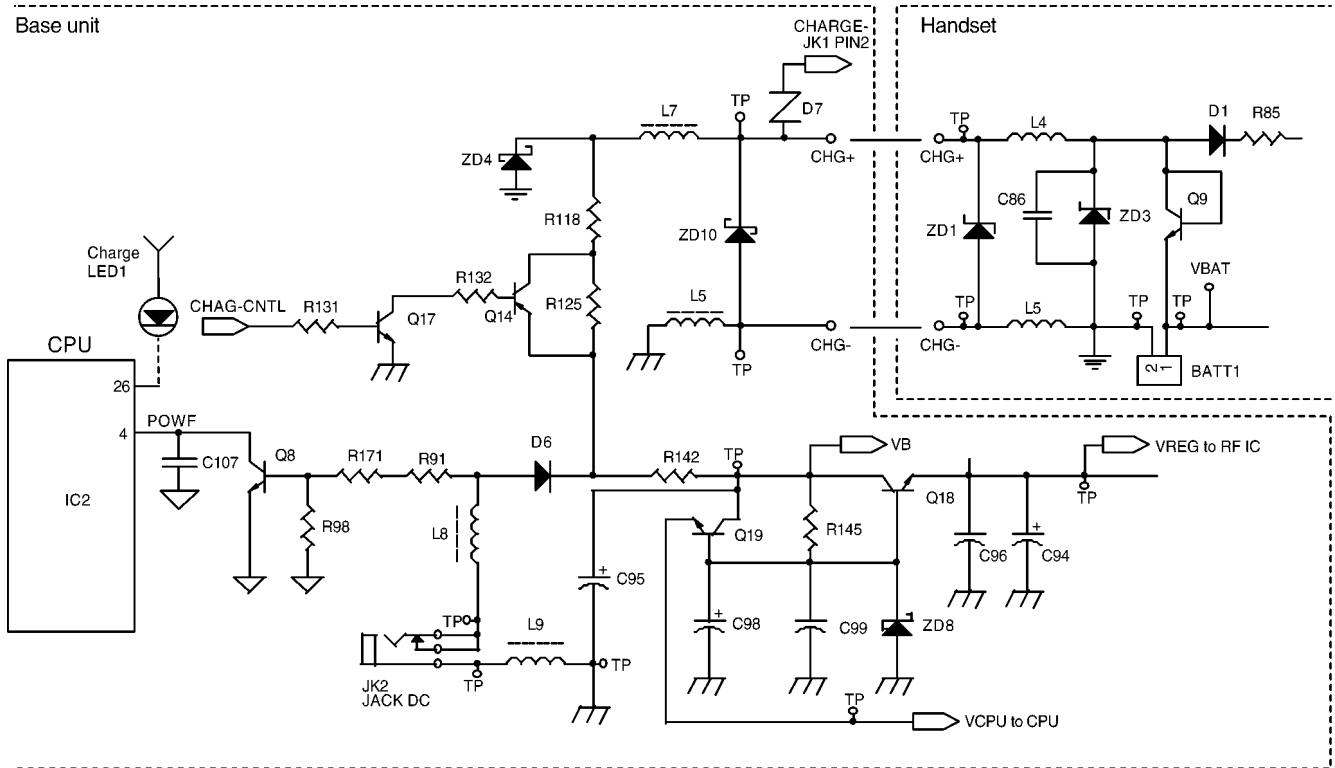

Fig. 1

16.3. Reset Circuit (Base Unit)

After power supply from AC adaptor, the VREG is input for making reset signal. Refer to the below waveform.

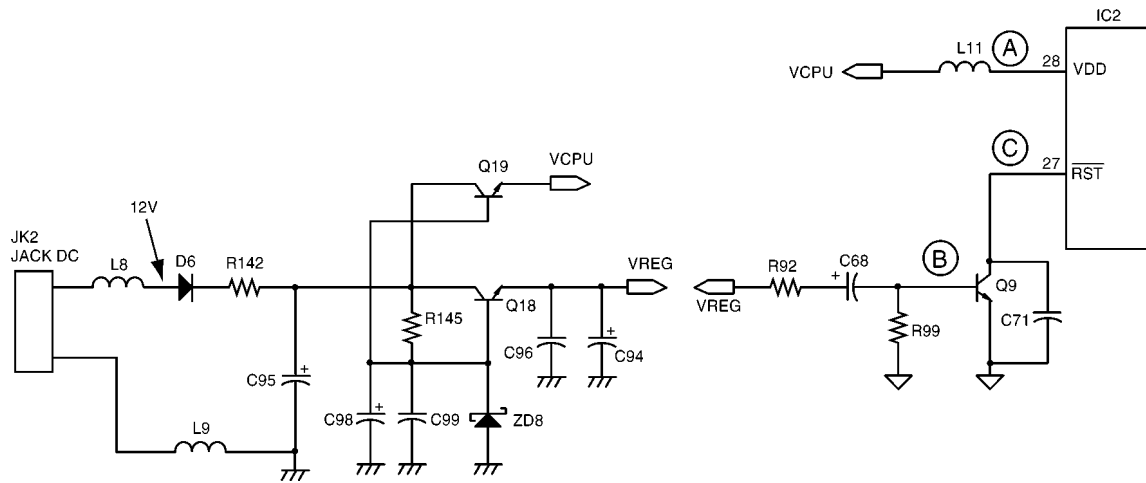

Fig. 2

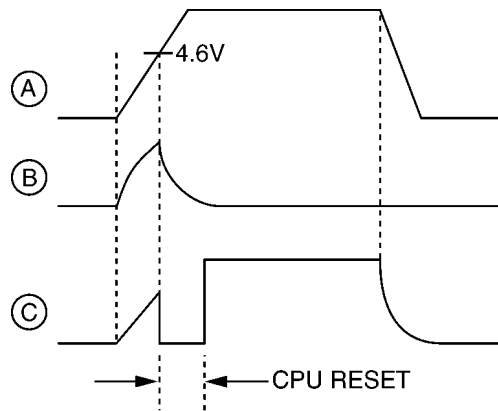

Fig. 3

16.4. Charge Circuit

Circuit Operation:

When charging the handset on the base unit, the charge current is as follows;

DC (JK2) → L8 → D6 → L7 → CHG+(Base) → [CHG+(Handset) → L4 → Q9 → BATT(1)...Battery...BATT(2) → L5 → CHG-(Handset)] → CHG+(Base) → L5,

In this way, the CPU on both unit detects the fact that the battery is charged.

The charge current is controlled by switching Q701 of Handset. The battery is charged in normal mode for 10 hours and then in trickle mode.

16.5. Telephone Line Interface

Function:

- Bell signal detection
- ON/OFF hook and pulse dial circuit
- Side tone circuit

Bell signal detection and OFF HOOK circuit:

In the idle mode, Q103 is open to cut the DC loop current and decrease the ring load. When ring voltage appears at the Tip (T) and Ring (R) leads (when the telephone rings), the AC ring voltage is transferred as follows.

JK1 (3): T → L6 → R144 → IC3D (12,13 → 14) → C97 → R148 → Q20 → IC2 (24) [BELL]

JK1 (2): R → L4 → R120 → R152 → ↑

When the CPU (DSP) detects a ring signal and press the TALK Key on the handset. Q6 turns on and then RY1 turns on, thus providing an off-hook condition (active DC current flow through the circuit) and the following signal flow is for the loop current.

T → R160 → L4 → RY1 → R107 → T7 → R116 → D5 → L6 → R161 → R [OFF HOOK]

ON HOOK Circuit:

Q6 is open, RY1 disconnected as to cut the DC loop current and to cut the voice signal. The unit is consequently in an on-hook condition.

Pulse Dial Circuit:

DSP (Relay) turns RY1 ON/OFF to make the pulse dialing via Q6.

Make/Break ratio when dialing with the Handset: 40%:60%

Side Tone Circuit:

Basically this circuit prevents the TX signal from feeding back to RX signal.

As for this unit, TX signal feed back from Q11 is canceled by the cancellor circuit of AGC.

16.6. Transmitter/Receiver

Base Unit and Handset are mainly consists of RF(Radio Frequency) IC and CPU.

Base Unit and Handset transmit/receive voice signal and data signal through the antenna on carrier frequency.

Signal Pass :

*Refer to CDL TX/RX in **Signal Route** (P.44).

16.6.1. Base to Handset

Circuit Operation:

The voice signal input from the TEL LINE interface goes to RF IC as shown in

BLOCK DIAGRAM (BASE UNIT) (P.36).

In the talk mode (off-hook) condition, the telephone line voice signal passes through D2, D3, D4, D5, RY1 (Relay), R107 and T7.

The other party's voice signal is coupled with T7 and amplified by Q11 and led to IC3-B (OP Amplifier device).

And the signal goes through the compressor of RF IC, it is output to transmitter circuit.

The signal of the data sent to the handset is applied in the anode of the variable capacitor diode (VARICAP : DV1).

The capacitor of VARICAP is changing in accordance with the voice signal from telephone line interface or TX DATA signal from CPU.

Therefore, the carrier frequency which is generated by TXVCO will be changing, and Frequency modulated RF signal is generated and amplified by RF AMP(Q3, Q4, T5).

It pass through the Duplexer DPX1 and radiated from Antenna.

The signal is transmitted from the base unit and received by the handset antenna and amplified by RF amplifier (Q1) through DPX1 as shown in **BLOCK DIAGRAM (HANDSET)** (P.37). And then it is converted to 10.7 MHz and 450 KHz Intermediate frequency by RF IC and related components.

The demodulated audio signal is output from RF IC (DET OUT) and passed through "Expander" process to reduce noise, then voice signal amplified by "Receiver amplifier" is output to receiver (REC1).

The receiver loudness is adjustable using "LOUD" key on the handset. Q2 and Q3 control the volume. When CPU (VOL1) becomes low, the volume becomes "MID", while CPU (VOL 1,2) becomes low, the volume becomes "HIGH".

TX data (to Handset)

CPU (VTX) becomes low to turn on the transmission power transistor Q2, and CPU (TX-data) sends data signal. It is FM-modulated by TXVCO and driven by RF AMP, then transmitted to the handset.

16.6.2. Handset to Base

Circuit Operation:

The voice signal from the handset user is picked up by the microphone (MC1), voice signal passes through "Compressor" process to reduce noise as shown in **BLOCK DIAGRAM (HANDSET)** (P.37). And the voice is FM-modulated by VARICAP (DV1).

The carrier frequency is generated by TX VCO. The transmitter power transistor Q4 is turned on/off by CPU (VTX).

The carrier signal is amplified by RF AMP and sent to the handset duplexer and antenna.

The signal of 49MHz band (49.670~49.99MHz) which is input from ANT is filtered at DPX1 as shown in **BLOCK DIAGRAM (BASE UNIT)** (P.36), then it is input to RF IC.

The signal input to RF IC is converted through Mixer inside of RF IC, RF filter (CF1, CF2) and Expander.

The signal is transmitted from the handset and received by the base unit antenna and amplified by RF amplifier Q1, then it is converted to 10.7 MHz and 450 KHz Intermediate by RF IC. The demodulated audio signal is output from RF IC (DET OUT) and passed through "Expander" process to reduce noise, then voice signal is led to LINE AMP.

The signal is passed through TELEPHONE INTERFACE and Tel-line.

RX data (from Handset):

The data signal from handset (ex: Talk, ACK, COM) is also included in 49 MHz band same as the voice data. After second if filter, the data signal is made square shape by data limiting AMP of the RF IC. RX data is output to CPU (RX Data).

16.6.3. RF signal operation/control and PLL operation (RF UNIT)

Base unit radio frequency signal received by antenna passes through duplexer (DPX1). RF signal is amplified by RF AMP.

RF signal received from RF IC is mixed with RX local frequency at Mixer to generate 10.7 MHz wide band IF. The reference frequency is generated by X1 11.15 MHz crystal.

VC1 is the reference frequency for adjustment. The 10.7 MHz is mixed with reference and 450KHz narrow band IF is generated. The demodulation audio signal is adjusted to the maximum at T1.

RF IC is controlled by CPU (RF_STB, DATA, CLK). The RX local frequency is generated by RXVCO.

16.7. Signal Route

Each signal route is as follows.

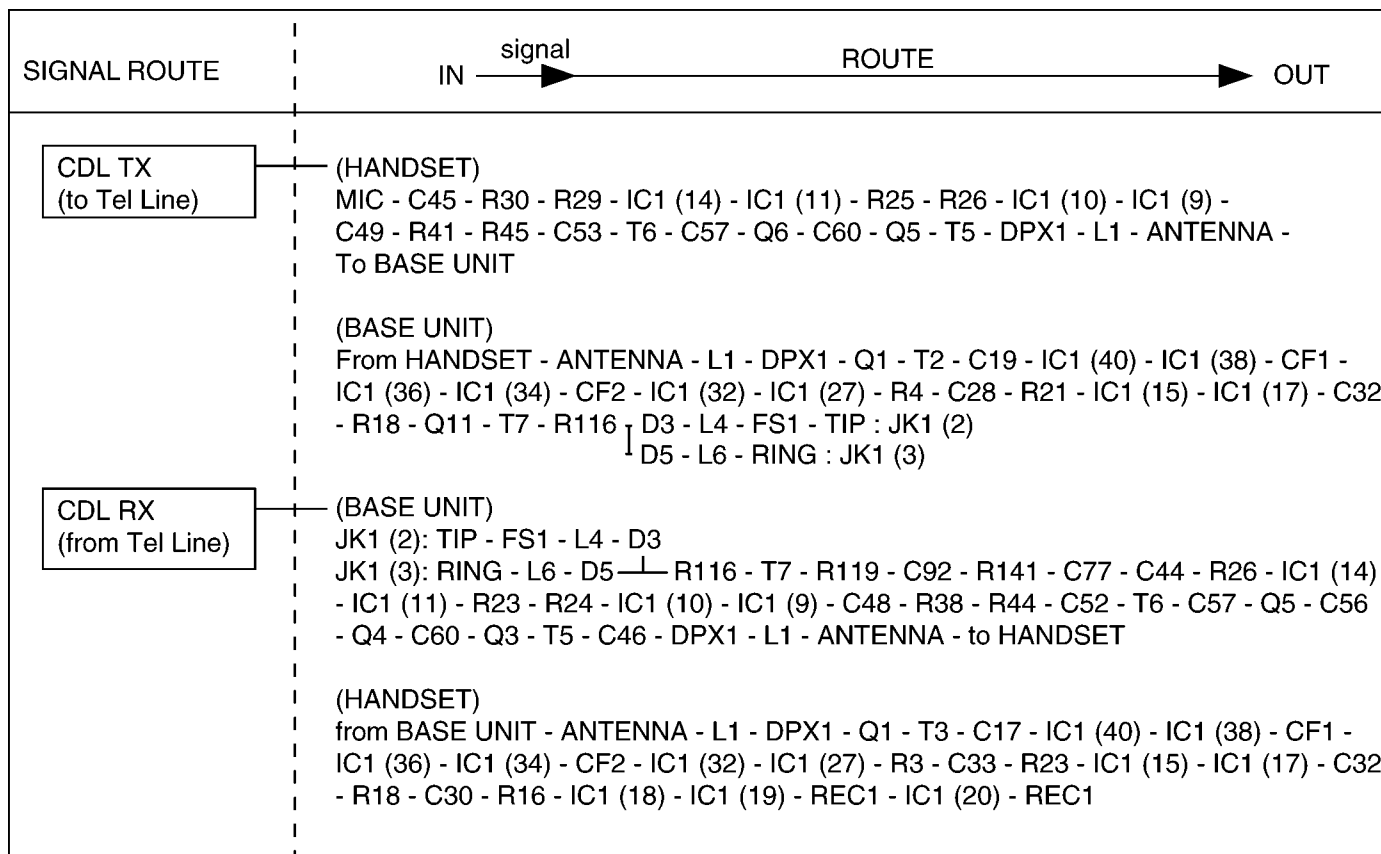

17 CIRCUIT OPERATION (HANDSET)

17.1. Reset Circuit (Handset)

The power of handset is supplied by battery.

Whenever the battery is recharged or inserted, the impulse at CHG+ becomes Reset signal through Q11, and sent to CPU.

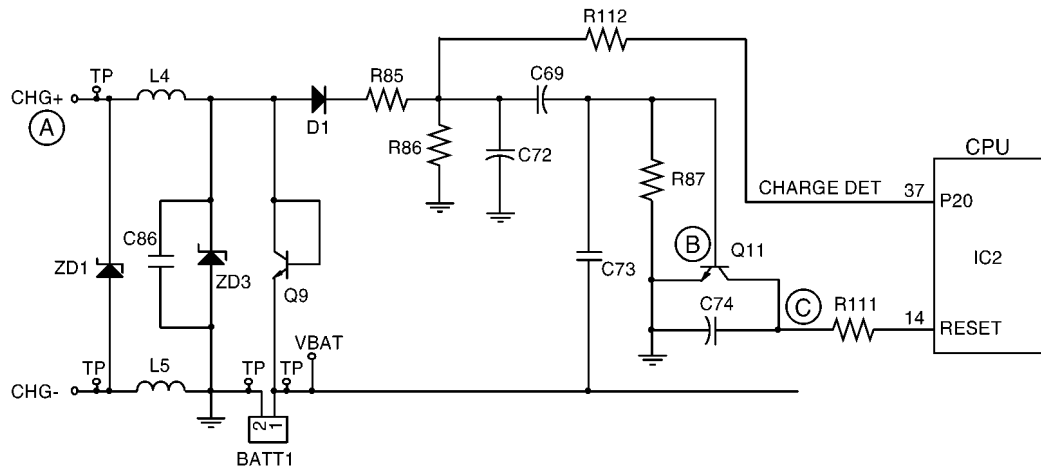

Fig. 4

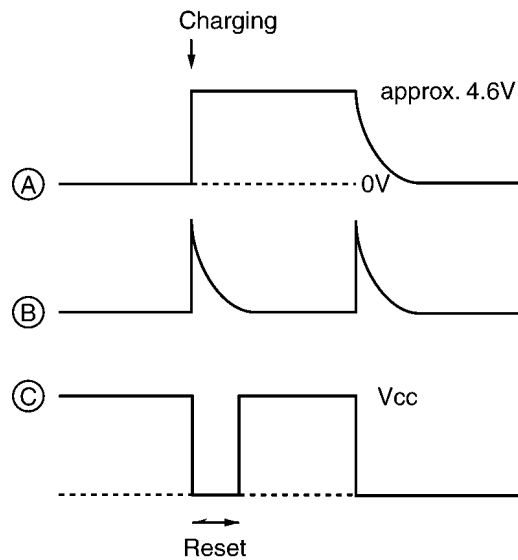

Fig. 5

17.2. Battery Low / Power Down Detector

Circuit Operation:

“Battery Low” and “Power Down” are detected by RF IC which check the voltage from battery. Shortly, every detected blocks are inside of RF IC. The detected voltage is as follows;

- Battery Low

Battery voltage : $V(\text{Batt}) < 3.57\text{V}$

The CPU detects this level and “Recharge battery” LED starts flashing.

- Power Down

Battery voltage : $V(\text{Batt}) < 3.3\text{V}$

The output of RF IC (P-DOWN) becomes low level, then CPU stops working to keep the data (CH number, ID Code, etc.)

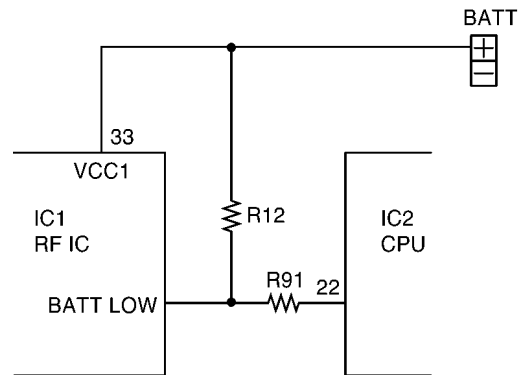

Fig. 6

18 CPU DATA (Base Unit)

18.1. IC2

Pin	Description	I/O	High	Hi-z	Low
1	NC	A.O	-	-	-
2	NC	A.I	-	-	-
3	NC	D.I	-	-	-
4	PWRDET	D.I	Active	-	Normal
5	DTMF4	D.O	Active	-	Normal
6	DTMF3	D.O	Active	-	Normal
7	DTMF2	D.O	Active	-	Normal
8	DTMF1	D.O	Active	-	Normal
9	DTMF0	D.O	Active	-	Normal
10	RXD	D.I	-	-	-
11	COUNT0	D.I	-	-	-
12	ASTB	D.O	Active	-	Normal
13	ADAT	D.O	-	-	Normal
14	NC	-	-	-	-
15	ACLK	D.O	-	-	Normal
16	PULSEMUTE	D.O	Active	-	Normal
17	TXD	D.O	Active	Normal	Active
18	CHGDET	D.I	Active	-	Normal
19	CNDET	D.I	Active	-	Normal
20	VTX	D.O	Normal	-	Active
21	HOOK	D.O	Active	-	Normal
22	PAGE	D.I	Normal	-	Active
23	COUNT1	D.I	-	-	-
24	RINGDET	D.I	-	-	-
25	CHARG-CNT	D.O	Normal	-	Active
26	LINELED	D.O	Normal	-	Active
27	NC	D.I	-	-	-
28	NC	-	-	-	-

19 CPU DATA (Handset)

19.1. IC2

Pin	Description	I/O	High	Hi-z	Low
1	ADAT	D.O	-	-	Normal
2	ACLK	D.O	-	-	Normal
3	VTX	D.O	Normal	-	Active
4	RXD	D.I	-	-	-
5	BACKLED	D.O	Active	-	Normal
6	LINELED	D.O	Normal	-	Active
7	LOWLED	D.O	Normal	-	Active
8	ROW3	D.I	Normal	-	Active
9	ROW2	D.I	Normal	-	Active
10	ROW1	D.I	Normal	-	Active
11	ROW0	D.I	Normal	-	Active
12	NC	D.O	Normal	-	-
13	NC	D.I	-	-	Normal
14	RESET	D.I	Normal	-	Reset
15	fc	A.I	-	-	-
16	fc	A.O	-	-	-
17	GND	-	-	-	-
18	VDD	A.I	-	-	-
19	OPTION 0	D.I	-	-	-
20	OPTION 1	D.I	-	-	-
21	OPTION 2	D.I	-	-	-
22	BATTDET	D.I	Active	-	Normal
23	CRDET	D.I	Active	-	Normal
24	NC	D.O	Normal	-	-
25	NC	D.O	Normal	-	-
26	NC	D.O	Normal	-	-
27	NC	D.O	Normal	-	-
28	NC	D.O	Normal	-	-
29	COL 0	D.O	Normal	-	Active
30	COL 1	D.O	Normal	-	Active
31	COL 2	D.O	Normal	-	Active
32	ALERT	D.O	Normal	-	Active
33	COL 3	D.O	Normal	-	Active
34	COL 4	D.O	Normal	-	Active
35	COL 5	D.O	Normal	-	Active
36	TXD	D.O	Active	Normal	Active
37	CHGDET	D.I	Active	-	Normal
38	fs	A.I	-	-	-
39	fs	A.O	-	-	-
40	NC	-	-	-	-
41	RINGVOL	D.O	Active	-	Normal
42	VOL 0	D.O	Active	-	Normal
43	VOL 1	D.O	Active	-	Normal
44	ASTB	D.O	Active	-	Normal

20 HOW TO REPLACE FLAT PACKAGE IC

20.1. Preparation

- SOLDER
Sparkle Solder 115A-1, 115B-1 or Almit Solder KR-19, KR-19RMA
- Soldering iron
Recommended power consumption will be between 30 W to 40 W.
Temperature of Copper Rod 662 ± 50°F (350 ± 10°C)
(An expert may handle between 60 W to 80 W iron, but beginner might damage foil by overheating.)
- Flux
HI115 Specific gravity 0.863.
(Original flux will be replaced daily.)

20.2. Procedure

1. Temporary fix FLAT PACKAGE IC by soldering on two marked 2 pins.

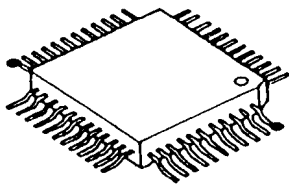

- - - - - - Temporary soldering point.

*Most important matter is accurate setting of IC to the corresponding soldering foil.

2. Apply flux for all pins of FLAT PACKAGE IC.

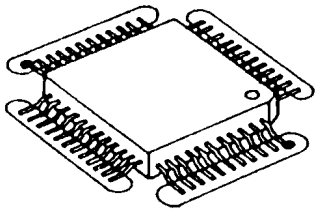

- - - - - Flux

3. Solder employing specified solder to direction of arrow, as sliding the soldering iron.

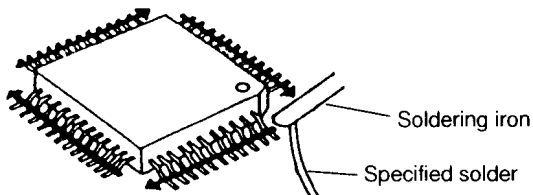

20.3. Modification Procedure of Bridge

1. Re-solder slightly on bridged portion.
2. Remove remained solder along pins employing soldering iron as shown in below figure.

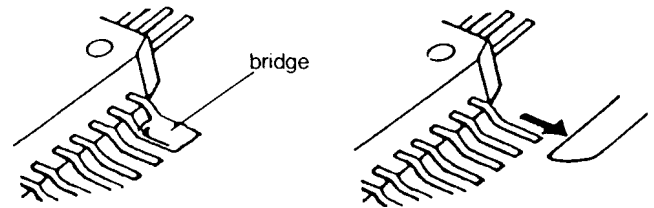

21 CABINET AND ELECTRICAL PARTS LOCATION (BASE UNIT)

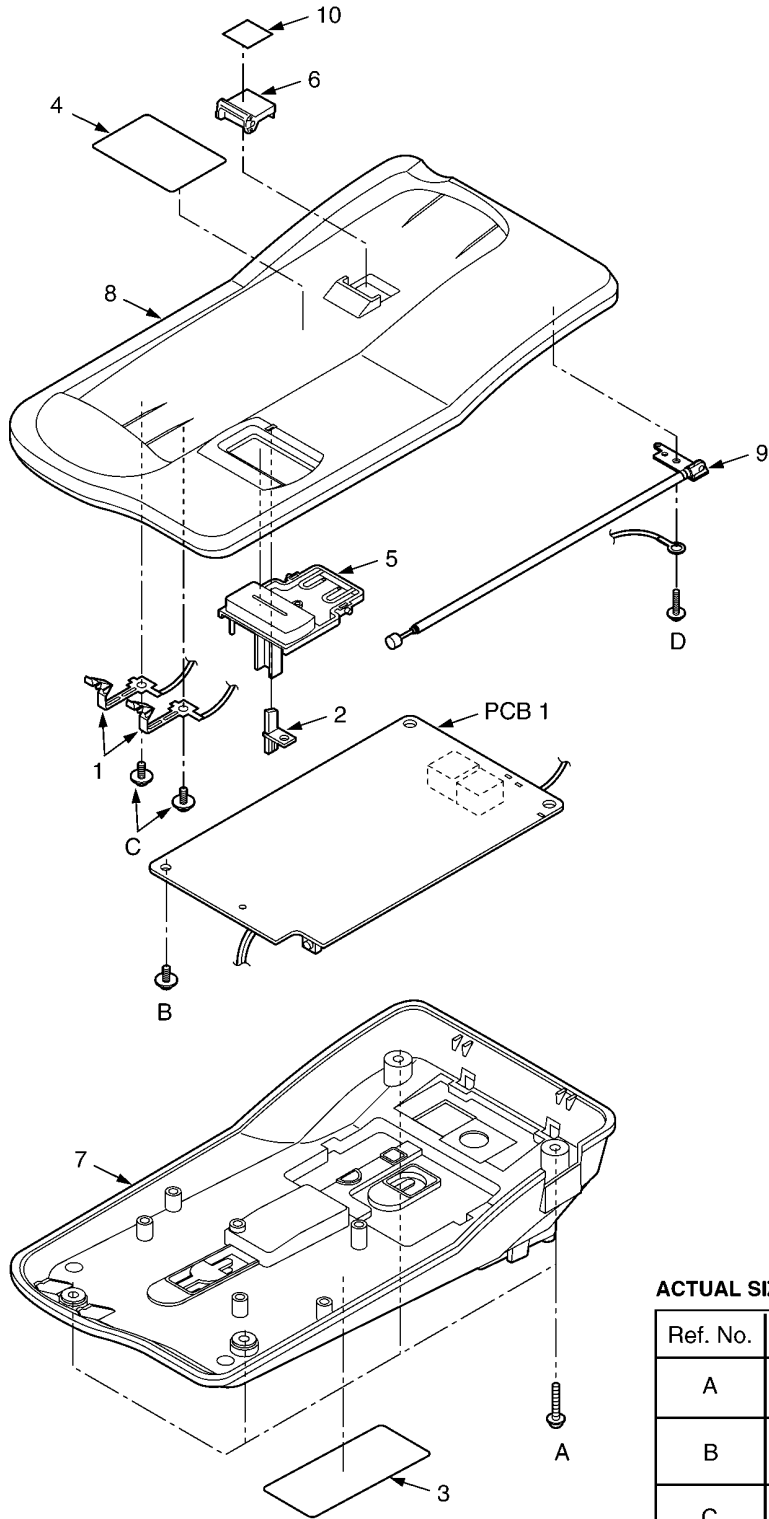



ACTUAL SIZE OF SCREWS

Ref. No.	Part No.	Screw
A	MABOG261247	
B	MABOG260640	
C	MABOG260640	
D	MABOE261244	

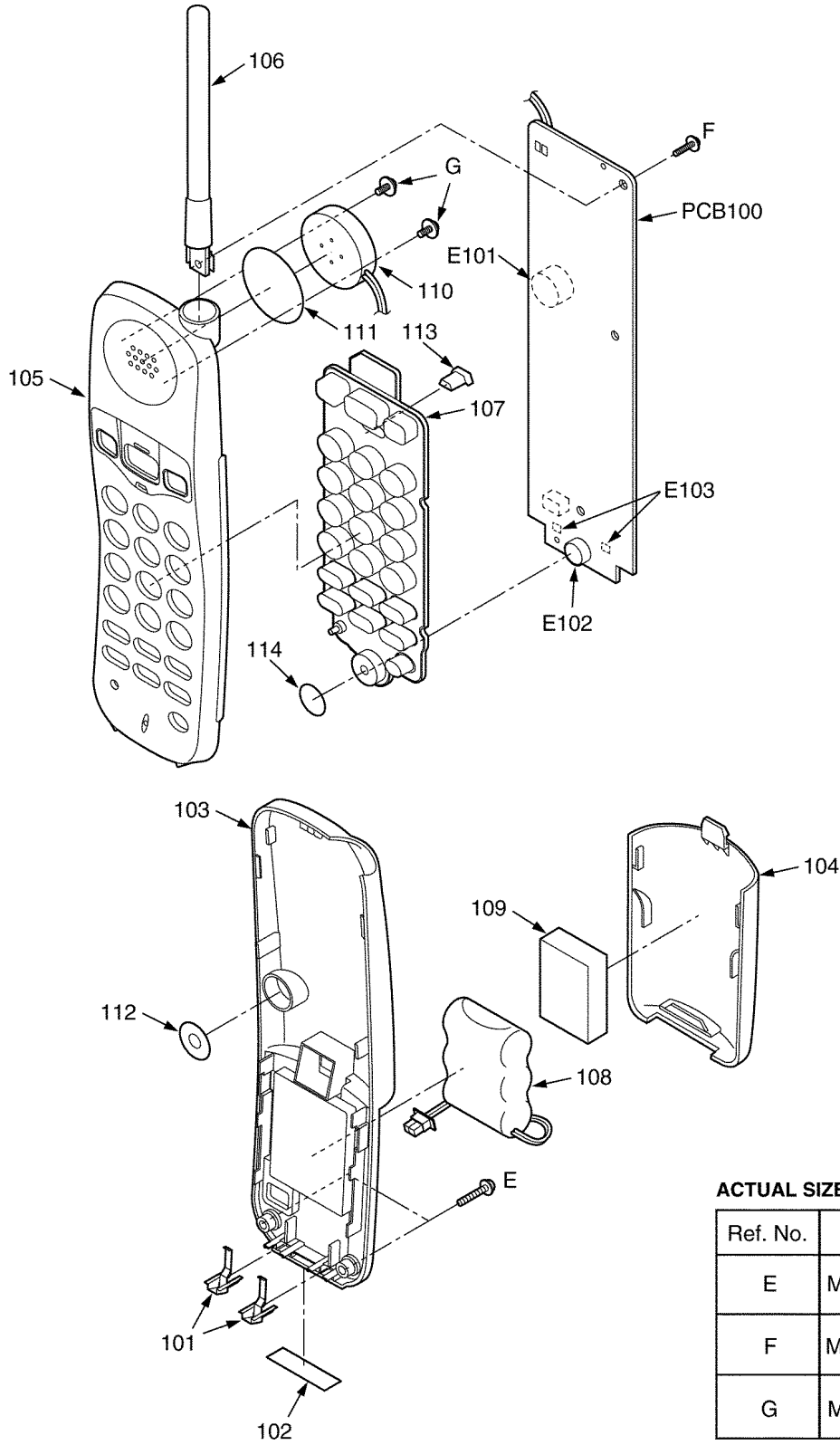
22 CABINET AND ELECTRICAL PARTS LOCATION (HANDSET)

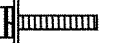

ACTUAL SIZE OF SCREWS

Ref. No.	Part No.	Screw
E	MABOG261247	
F	MABOE261244	
G	MABOG260640	

23 ACCESSORIES AND PACKING MATERIALS

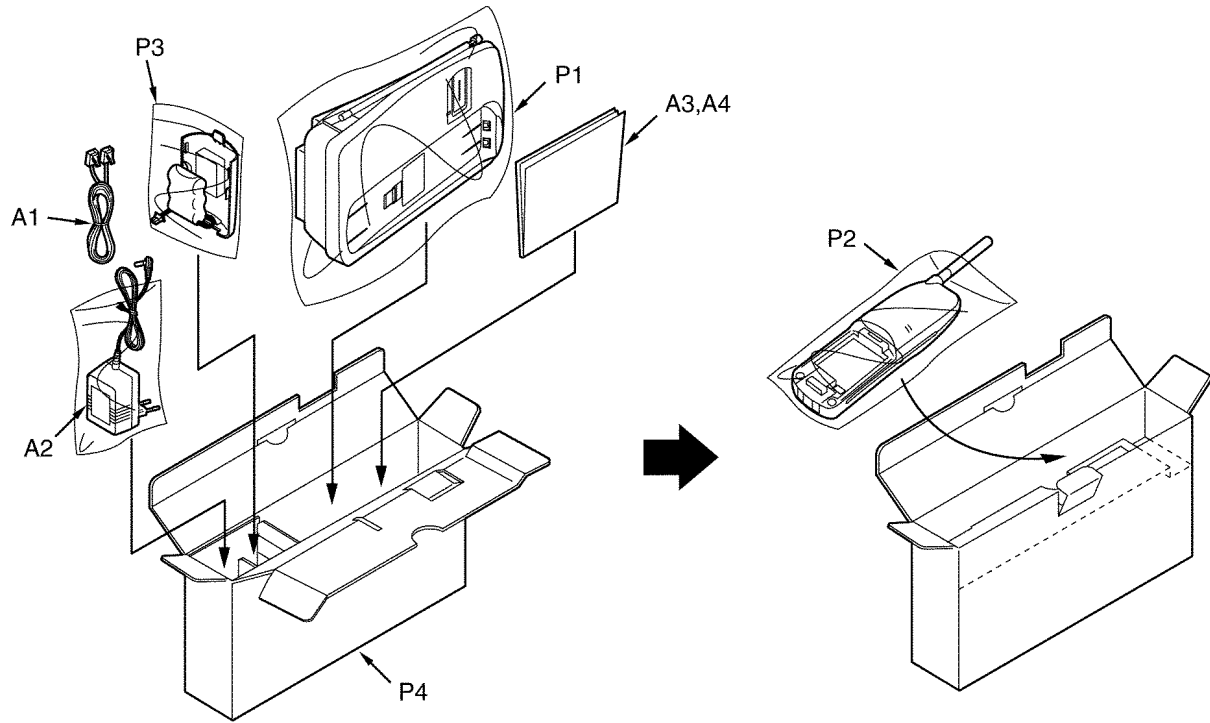

24 REPLACEMENT PARTS LIST

Note:

1. RTL (Retention Time Limited)

The marking (RTL) indicates that the Retention Time is limited for this item.

After the discontinuation of this assembly in production, the item will continue to be available for a specific period of time. The retention period of availability depends on the type of assembly and the laws governing parts and product retention.

At the end of this period, the assembly will no longer be available.

2. Important safety notice

Components identified by the Δ mark indicates special characteristics important for safety. When replacing any of these components, only use specified manufacture's parts.

3. The S mark means the part is one of some identical parts. For that reason, it may be different from the installed part.

4. RESISTORS & CAPACITORS

Unless otherwise specified;

All resistors are in ohms (Ω) K=1000 Ω , M=1000k Ω

All capacitors are in MICRO FARADS (μ F) P= μ F

*Type & Wattage of Resistor

Type

ERC:Solid	ERX:Metal Film	PQ4R:Carbon
ERD:Carbon	ERG:Metal Oxide	ERS:Fusible Resistor
PQRD:Carbon	ER0:Metal Film	ERF:Cement Resistor

Wattage

10,16:1/8W	14,25:1/4W	12:1/2W	1:1W	2:2W	3:3W
------------	------------	---------	------	------	------

*Type & Voltage of Capacitor

Type

ECFD:Semi-Conductor	ECCD,ECKD,ECBT,PQCBC : Ceramic
ECQS:Styrol	ECQE,ECQV,ECQG : Polyester
PQCUV:Chip	ECEA,ECSZ : Electrolytic
ECQMS:Mica	ECQP : Polypropylene

Voltage

ECQ Type	ECQG ECQV Type	ECSZ Type	Others		
1H: 50V	05: 50V	0F:3.15V	0J :6.3V	1V :35V	
2A:100V	1:100V	1A:10V	1A :10V	50,1H:50V	
2E:250V	2:200V	1V:35V	1C :16V	1J :63V	
2H:500V		0J:6.3V	1E,25:25V	2A :100V	

24.1. Base Unit

24.1.1. CABINET AND ELECTRICAL PARTS

Ref. No.	Part No.	Part Name & Description	Remarks
1	PQJT10180Z	CHARGE TERMINAL	
2	PQHR10882Z	LED LENS	
3	PQGT15032Z	NAME LABEL (for KX-TC1205RUB)	
3	PQGT14900Z	NAME LABEL (for KX-TC1205RUW)	
3	PQGT14901Z	NAME LABEL (for KX-TC1205RUS)	
3	PQGT14902Z	NAME LABEL (for KX-TC1205RUF)	
4	PQQT22474Z	CHARGE LABEL	
5	PQBC10349Z1	PUSH BUTTON (for KX-TC1205RUB)	S

Ref. No.	Part No.	Part Name & Description	Remarks
5	PQBC10349Z3	PUSH BUTTON (for KX-TC1205RUW)	S
5	PQBC10349Z2	PUSH BUTTON (for KX-TC1205RUS/KX-TC1205RUF)	S
6	PQKE10335Z1	HOOK LEVER (for KX-TC1205RUB)	S
6	PQKE10335Z5	HOOK LEVER (for KX-TC1205RUW)	S
6	PQKE10335Z4	HOOK LEVER (for KX-TC1205RUS)	S
6	PQKE10335Z2	HOOK LEVER (for KX-TC1205RUF)	S
7	PQKF10534Y1	LOWER CABINET (for KX-TC1205RUB/KX-TC1205RUF)	S
7	PQKF10534Y3	LOWER CABINET (for KX-TC1205RUW)	S
7	PQKF10534Y2	LOWER CABINET (for KX-TC1205RUS)	S
8	PQKM10509W1	UPPER CABINET (for KX-TC1205RUB)	S
8	PQKM10509W4	UPPER CABINET (for KX-TC1205RUW)	S
8	PQKM10509W3	UPPER CABINET (for KX-TC1205RUS)	S
8	PQKM10509W2	UPPER CABINET (for KX-TC1205RUF)	S
9	PQSA10104Y	ANTENNA	
10	XXLABALACE1	HOOK LABEL (for KX-TC1205RUB)	
10	XXLASILUER1	HOOK LABEL (for KX-TC1205RUW/KX-TC1205RUS/KX-TC1205RUF)	

24.1.2. MAIN P.C.BOARD PARTS

Ref. No.	Part No.	Part Name & Description	Remarks
PCB1	PQWPC1205RUH	MAIN P.C.BOARD ASS'Y (RTL)	
		(ICS)	
IC1	SA133122409	IC	
IC2	SA138740577	IC	
IC3	SA110032403	IC	
IC4	AN6183S	IC	
		(TRANSISTORS)	
Q1	BB230024104	TRANSISTOR(SI)	
Q2	SB010390608	TRANSISTOR(SI)	
Q3	SB110390405	TRANSISTOR(SI)	
Q4	SB110390405	TRANSISTOR(SI)	
Q5	SB110390405	TRANSISTOR(SI)	
Q6	SB110390405	TRANSISTOR(SI)	
Q7	SB110390405	TRANSISTOR(SI)	
Q8	SB110390405	TRANSISTOR(SI)	
Q9	SB110390405	TRANSISTOR(SI)	
Q10	BB010009408	TRANSISTOR(SI)	
Q11	SB110390405	TRANSISTOR(SI)	
Q14	SB010390608	TRANSISTOR(SI)	
Q16	SB110390405	TRANSISTOR(SI)	
Q17	SB110390405	TRANSISTOR(SI)	
Q18	BB1G0390403	TRANSISTOR(SI)	
Q19	BB1G0390403	TRANSISTOR(SI)	
Q20	SB110390405	TRANSISTOR(SI)	
Q21	SB110390405	TRANSISTOR(SI)	
		(DIODES)	
D1	SC15L414808	DIODE(SI)	
D2	BC2G0400400	DIODE(SI)	
D3	BC2G0400400	DIODE(SI)	
D4	BC2G0400400	DIODE(SI)	
D5	BC2G0400400	DIODE(SI)	
D6	BC2G0400400	DIODE(SI)	
D9	SC15L414808	DIODE(SI)	
D10	SC15L414808	DIODE(SI)	
DV1	BC6K0025101	DIODE(SI)	
ZD1	BC050474801	DIODE(SI)	
ZD2	BC050474801	DIODE(SI)	
ZD3	SC4555C4V71	DIODE(SI)	
ZD5	SC4555C4V71	DIODE(SI)	
ZD6	BC2G0400400	DIODE(SI)	
ZD7	BC4579C2702	DIODE(SI)	
ZD8	BC4579C5V65	DIODE(SI)	
ZD10	SC4555C1506	DIODE(SI)	

Ref. No.	Part No.	Part Name & Description	Remarks
ZD11	SV110201203	DIODE(SI)	
ZNR1	VA107D271K1	DIODE(SI)	
		(COILS)	
L1	PQLQZK2R2J	COIL	
L4	PQLQZK120J	COIL	
L5	PQLQZK120J	COIL	
L6	PQLQZK120J	COIL	
L7	PQLQZK120J	COIL	
L10	PQLQZK120J	COIL	
L12	SH4Y0750K46	COIL	
		(CONNRCTORS)	
JK1	DC72P120018	JACK/SOCKET	
JK2	DC71P120023	JACK/SOCKET	
		(CERAMIC FILTERS)	
CF1	BDFL107MA53	CERAMIC FILTER	
CF2	BDFL0455E02	CERAMIC FILTER	
DPX1	BDFL0083004	CERAMIC FILTER	
		(CRYSTAL OSCILLATORS)	
X1	BDR1024504	CRYSTAL OSCILLATOR	
X2	BDRR0800005	CRYSTAL OSCILLATOR	
		(TRANSFORMERS)	
T1	CLIP1200053	TRANSFORMER	
T2	CLIP1200100	TRANSFORMER	
T5	CLIP1200096	TRANSFORMER	
T6	CLIP1200142	TRANSFORMER	
T7	DG0P1200035	TRANSFORMER	
		(OTHERS)	
D7	PQVDDSP272M	VARISTOR	
IC5	PQVIPC817K	PHOTO ELECTRIC TRANSDUCER	
LED1	SC5E0192115	LED	
RY1	DCR000105H7	RELAY	
SW1	DETP1200017	PUSH SWITCH	
VC1	CR00020RRT5	TRIMMER CAPACITOR	
		(RESISTORS)	
R1	ERJ3GEYJ470	47	
R2	ERJ3GEYJ330	33	
R3	ERJ3GEYJ153	15k	
R4	ERJ3GEYJ822	8.2k	
R5	ERJ3GEYJ103	10k	
R6	ERJ3GEYJ103	10k	
R7	ERJ3GEYJ334	330k	
R8	ERJ3GEYJ103	10k	
R10	ERJ3GEYJ393	39k	
R11	ERJ3GEYJ102	1k	
R12	ERJ3GEYJ101	100	
R13	ERJ3GEYJ623	62k	
R14	ERJ3GEYJ103	10k	
R15	ERJ3GEYJ562	5.6k	
R16	ERJ3GEYJ153	15k	
R17	ERJ3GEY0R00	0	
R18	ERJ3GEYJ472	4.7k	
R19	ERJ3GEYJ124	120k	
R20	ERJ3GEYJ475	4.7M	
R21	ERJ3GEYJ473	47k	
R22	ERJ3GEYJ472	4.7k	
R23	ERJ3GEYJ563	56k	
R24	ERJ3GEYJ103	10k	
R25	ERJ3GEYJ683	68k	
R26	ERJ3GEYJ473	47k	
R27	PQ4R10XJ560	56	S
R29	ERJ3GEY0R00	0	
R30	ERJ3GEYJ104	100k	
R31	ERJ3GEYJ473	47k	
R32	ERJ3GEYJ105	1M	
R33	ERJ3GEY0R00	0	
R35	ERJ3GEYJ101	100	
R36	ERJ3GEYJ224	220k	
R37	ERJ3GEYJ101	100	
R38	ERJ3GEYJ823	82k	
R40	ERJ3GEYJ223	22k	
R41	ERJ3GEYJ473	47k	
R42	ERJ3GEYJ103	10k	
R43	ERJ3GEYJ393	39k	

Ref. No.	Part No.	Part Name & Description	Remarks
R44	ERJ3GEYJ104	100k	
R45	ERJ3GEYJ334	330k	
R46	ERJ3GEYJ222	2.2k	
R48	ERJ3GEYJ223	22k	
R49	ERJ3GEYJ473	47k	
R50	ERJ3GEYJ822	8.2k	
R51	ERJ3GEYJ182	1.8k	
R52	ERJ3GEYJ225	2.2M	
R53	ERJ3GEYJ153	15k	
R55	ERJ3GEYJ681	680	
R56	ERJ3GEYJ222	2.2k	
R57	ERJ3GEYJ224	220k	
R58	ERJ3GEYJ511	510	
R59	ERJ3GEYJ104	100k	
R60	ERJ3GEYJ223	22k	
R61	ERJ3GEYJ224	220k	
R63	ERJ3GEYJ104	100k	
R64	ERDS2TJ103	10k	
R68	ERJ3GEYJ104	100k	
R74	ERJ3GEY0R00	0	
R75	ERJ3GEYJ103	10k	
R77	ERJ3GEYJ203	20k	
R78	ERJ3GEYJ393	39k	
R79	ERJ3GEYJ823	82k	
R80	ERJ3GEYJ222	2.2k	
R81	ERJ3GEYJ164	160k	
R82	ERJ3GEYJ103	10k	
R83	ERJ3GEYJ103	10k	
R84	ERJ3GEYJ103	10k	
R85	ERJ3GEYJ103	10k	
R86	ERJ3GEYJ473	47k	
R87	ERJ3GEYJ102	1k	
R88	ERJ3GEYJ103	10k	
R89	ERJ3GEYJ103	10k	
R90	ERJ3GEYJ304	300k	
R91	ERJ3GEYJ154	150k	
R92	ERJ3GEYJ103	10k	
R93	ERJ3GEYJ104	100k	
R95	ERJ3GEYJ392	3.9k	
R96	ERJ3GEYJ274	270k	
R97	ERJ3GEYJ822	8.2k	
R98	ERJ3GEYJ123	12k	
R99	ERJ3GEYJ823	82k	
R100	ERJ3GEYJ104	100k	
R103	ERJ3GEYJ223	22k	
R104	ERJ3GEYJ472	4.7k	
R105	ERJ3GEYJ472	4.7k	
R106	ERDS2TJ220	22	
R107	CQ63110RJ21	110	
R108	ERJ3GEYJ472	4.7k	
R109	ERJ3GEYJ334	330k	
R110	ERJ3GEYJ104	100k	
R111	ERJ3GEYJ471	470	
R112	ERJ3GEYJ102	1k	
R113	ERDST1TJ330	33	
R114	ERJ3GEYJ223	22k	
R115	ERJ3GEYJ563	56k	
R116	ERJ3GEY0R00	0	
R117	ERJ3GEYJ394	390k	
R118	ERDS1TJ150	15	
R119	ERJ3GEYJ823	82k	
R120	ERJ3GEY0R00	0	
R122	ERJ3GEYJ132	1.3k	
R123	ERJ3GEYJ153	15k	
R126	ERJ3GEYJ621	620	
R129	ERJ3GEYJ682	6.8k	
R131	ERJ3GEYJ104	100k	
R132	ERJ3GEYJ222	2.2k	
R133	ERJ3GEYJ820	82	
R134	ERJ3GEY0R00	0	
R135	ERJ3GEYJ152	1.5k	
R139	ERJ3GEYJ106	10M	
R141	ERJ3GEYJ512	5.1k	

Ref. No.	Part No.	Part Name & Description	Remarks
R142	ERDS2TJ220	22	
R143	ERJ3GEYJ514	510k	
R144	ERDS2TJ206	20M	
R145	ERJ3GEYJ102	1k	
R146	ERJ3GEYJ153	15k	
R148	ERJ3GEYJ103	10k	
R149	ERJ3GEYJ182	1.8k	
R150	ERJ3GEYJ514	510k	
R151	ERDST1TJ682	6.8k	
R152	ERDS2TJ206	20M	
R153	ERJ3GEYJ105	1M	
R154	ERJ3GEY0R00	0	
R155	ERJ3GEYJ470	47	
R156	ERJ3GEYJ470	47	
R159	ERJ3GEYJ104	100k	
R160	PQ4R10XJ000	0	S
R161	PQ4R10XJ000	0	S
R166	ERJ3GEYJ470	47	
R167	ERJ3GEYJ103	10k	
R170	ERJ3GEYJ102	1k	
R171	ERJ3GEYJ102	1k	
R172	ERDS2TJ223	22k	
R173	ERDS2TJ102	1k	
R174	ERDS2TJ102	1k	
R176	ERJ3GEY0R00	0	
R180	ERJ3GEYJ563	56k	
R181	ERJ3GEYJ330	33	
R186	ERJ3GEYJ472	4.7k	
R187	ERJ3GEYJ273	27k	
R188	ERJ3GEYJ103	10k	
R189	ERJ3GEYJ223	22k	
R190	ERJ3GEYJ103	10k	
R191	ERJ3GEYJ683	68k	
R192	ERJ3GEYJ124	120k	
R193	ERJ3GEYJ104	100k	
R194	ERJ3GEY0R00	0	
		(CAPACITORS)	
C1	ECEA1EK470	47	S
C2	ECUV1H473MDV	0.047	S
C4	ECUV1H103KBV	0.01	
C6	ECUV1C104ZFB	0.1	
C7	ECUV1H102KBV	0.001	
C8	ECUV1C104ZFB	0.1	
C9	ECUV1H471JCV	470p	
C10	ECUV1H471JCV	470p	
C11	ECUV1H473MDV	0.047	S
C12	ECUV1H103KBV	0.01	S
C15	ECEA1HU2R2	2.2	
C16	ECUV1H270JCV	27p	
C17	ECEA1AKA101	100	
C18	ECUV1C473KBV	0.047	
C19	ECUV1H102KBV	0.001	
C20	ECEA1HKA2R2	2.2	
C22	ECUV1H103KBV	0.01	S
C23	ECUV1H103KBV	0.01	S
C24	ECUV1E223ZFB	0.022	
C25	ECUV1H822KBV	0.0082	
C26	ECUV1H070DCV	7p	S
C27	ECUV1H103KBV	0.01	
C28	ECUV1C104KBV	0.1	
C29	ECUV1C104KBV	0.1	
C30	ECEA1HKA2R2	2.2	
C31	ECUV1H103KBV	0.01	
C32	ECEA1HU2R2	2.2	
C33	ECUV1H101JCV	100p	
C34	ECUV1H471JCV	470p	
C35	ECUV1H180JCV	18p	
C36	ECUV1H101JCV	100p	
C37	ECUV1H151JCV	150p	
C38	ECEA1HKS010	1	S
C39	ECUV1H103KBV	0.01	S
C40	ECUV1H270JCV	27p	
C41	ECEA1EK470	47	S

Ref. No.	Part No.	Part Name & Description	Remarks
C42	ECEA1HU2R2	2.2	
C43	ECUV1C104ZFB	0.1	
C44	ECUV1A105ZFB	1	
C45	ECUV1H682KBV	0.0068	
C46	ECUV1H102KBV	0.001	
C47	ECUV1H103KBV	0.01	S
C48	ECUV1H223KBV	0.022	S
C49	ECUV1H103KBV	0.01	S
C50	ECEA1HU220	22	S
C51	ECUV1H103KBV	0.01	S
C52	ECUV1H223KBV	0.022	S
C53	ECUV1H120JCV	12p	
C54	ECUV1H020CCV	2p	
C55	ECUV1H103KBV	0.01	S
C56	ECUV1H180JCV	18p	
C57	ECUV1H390JCV	39p	
C58	ECUV1H682KBV	0.0068	
C59	ECUV1H390JCV	39p	
C60	ECUV1H180JCV	18p	
C61	ECUV1C104ZFB	0.1	
C62	ECUV1H390JCV	39p	
C63	ECUV1H103KBV	0.01	S
C64	ECUV1C104ZFB	0.1	
C65	ECUV1H220JCV	22p	
C66	ECEA1AU101	100	
C67	ECUV1H220JCV	22p	
C68	ECEA1HKAR47	0.47	
C69	ECUV1H271JCV	270p	
C70	ECUV1H223KBV	0.022	S
C71	ECUV1C104ZFB	0.1	
C72	ECUV1H223KBV	0.022	S
C73	ECUV1C104ZFB	0.1	
C74	ECUV1C104ZFB	0.1	
C75	ECUV1H223KBV	0.022	S
C76	CATZ681KC68	680p	
C77	ECUV1H151JCV	150p	
C78	ECEA1AU471	470	
C79	ECUV1C104ZFB	0.1	
C80	CATZ681KC68	680p	
C81	CJB21004K00	1	
C82	ECUV1C104ZFB	0.1	
C85	ECUV1C683KBV	0.068	
C86	ECUV1H103KBV	0.01	S
C88	ECUV1A105ZFB	1	
C90	ECUV1C224KBV	0.22	
C92	ECUV1C104KBV	0.1	
C93	ECUV1H562KBV	0.0056	
C94	ECEA1CK101	100	S
C95	CB114714205	470	
C96	ECUV1H103KBV	0.01	S
C97	ECEA1HKA4R7	4.7	
C98	ECEA1EU221	220	
C99	ECUV1H103KBV	0.01	S
C100	CJB21004K00	1	
C101	ECUV1H562KBV	0.0056	
C102	ECEA1EU221	220	
C103	ECEA1AU470	47	
C104	ECUV1H390JCV	39p	
C104	ECFD1C104KD	104	
C105	ECEA1CKA100	10	
C106	ECUV1A105ZFB	1	
C107	ECUV1C104ZFB	0.1	
C108	ECUV1C104KBV	0.1	
C109	ECUV1H682KBV	0.0068	
C110	ECUV1H470JCV	47p	
C111	ECUV1H103KBV	0.01	S
C121	ECUV1H103KBV	0.01	S
C123	ECUV1C474ZFB	0.47	
C124	ECUV1C224KBV	0.22	
C125	ECUV1H100DCV	10p	S
C126	ECUV1C224KBV	0.22	
C127	ECEA1EK470	47	S
C128	ECUV1C104KBV	0.1	

Ref. No.	Part No.	Part Name & Description	Remarks
C129	ECUV1C104ZFB	0.1	
C130	ECEA1AKA101	100	
C131	ECUV1C104KBV	0.1	
C132	ECUV1C104KBV	0.1	
C133	ECUV1H390JCV	39p	

24.2. Handset

24.2.1. CABINET AND ELECTRICAL PARTS

Ref. No.	Part No.	Part Name & Description	Remarks
101	PQJT10182Z	CHARGE TERMINAL	
102	PQGT15033Z	NAME LABEL (for KX-TC1205RUB)	
102	PQGT14903Z	NAME LABEL (for KX-TC1205RUW)	
102	PQGT14904Z	NAME LABEL (for KX-TC1205RUS)	
102	PQGT14905Z	NAME LABEL (for KX-TC1205RUF)	
103	PQKF10535Y1	REAR CABINET (for KX-TC1205RUB)	S
103	PQKF10535Y5	REAR CABINET (for KX-TC1205RUW)	S
103	PQKF10535Y4	REAR CABINET (for KX-TC1205RUS)	S
103	PQKF10535Y2	REAR CABINET (for KX-TC1205RUF)	S
104	PQKK10124Z1	BATTERY COVER (for KX-TC1205RUB)	S
104	PQKK10124Z5	BATTERY COVER (for KX-TC1205RUW)	S
104	PQKK10124Z4	BATTERY COVER (for KX-TC1205RUS)	S
104	PQKK10124Z2	BATTERY COVER (for KX-TC1205RUF)	S
105	PQKM10510W1	FRONT CABINET (for KX-TC1205RUB)	S
105	PQKM10510W5	FRONT CABINET (for KX-TC1205RUW)	S
105	PQKM10510W4	FRONT CABINET (for KX-TC1205RUS)	S
105	PQKM10510W2	FRONT CABINET (for KX-TC1205RUF)	S
106	PQSA10084U	ANTENNA (for KX-TC1205RUB/KX-TC1205RUF)	
106	PQSA10084V	ANTENNA (for KX-TC1205RUW/KX-TC1205RUS)	
107	PQSX10191Z	KEYBOARD SWITCH (for KX-TC1205RUB/KX-TC1205RUF)	
107	PQSX10191V	KEYBOARD SWITCH (for KX-TC1205RUW)	
107	PQSX10191W	KEYBOARD SWITCH (for KX-TC1205RUS)	
108	PQXA36ASVC	BATTERY	
109	FH1T1200011	CUSHION, URETHANE FORM	
110	CG2P1200012	SPEAKER	
111	FE4T1200019	SP NET	
112	FH2T1200012	BUZZER SHEET	
113	PQHR10896Z	LIGHT PIPE	
114	FE4T1200027	MIC NET	

24.2.2. MAIN P.C.BOARD PARTS

Ref. No.	Part No.	Part Name & Description	Remarks
PCB100	PQWPC1205RUR	MAIN P.C.BOARD ASS'Y (RTL) (ICS)	
IC1	SA133122409	IC	
IC2	SA138780731	IC	
		(TRANSISTORS)	
Q1	SB110390405	TRANSISTOR(SI)	
Q2	SB110390405	TRANSISTOR(SI)	
Q3	SB110390405	TRANSISTOR(SI)	
Q4	SB010390608	TRANSISTOR(SI)	
Q5	SB110390405	TRANSISTOR(SI)	
Q6	SB110390405	TRANSISTOR(SI)	

Ref. No.	Part No.	Part Name & Description	Remarks
Q7	SB010390608	TRANSISTOR(SI)	
Q8	SB110390405	TRANSISTOR(SI)	
Q9	SB110390405	TRANSISTOR(SI)	
Q11	SB110390405	TRANSISTOR(SI)	
		(DIODES)	
D1	SC15L414808	DIODE(SI)	
D2	SC15L414808	DIODE(SI)	
D3	SC15L414808	DIODE(SI)	
DV1	BC6K0025101	DIODE(SI)	
ZD1	BC4579C1005	DIODE(SI)	
ZD3	SC455C5V601	DIODE(SI)	
		(LEDS)	
LED1	SC5E0192115	LED	
LED2	SC5E0192115	LED	
LED3	SC5E0192115	LED	
LED4	SC5E0192115	LED	
LED5	SC5E0192115	LED	
LED6	SC5E0192123	LED	
		(COILS)	
L1	PQLQZKR68J	COIL	
L2	PQLQZM120K	COIL	
L3	PQLQZM120K	COIL	
L4	PQLQZK120J	COIL	
L5	PQLQZK120J	COIL	
L6	PQLQZK1R8J	COIL	
L7	SH590121N75	COIL	
		(CERAMIC FILTERS)	
CF1	BDFL107MA53	CERAMIC FILTER	
CF2	BDFL0455E02	CERAMIC FILTER	
DPX1	BDFL0083012	CERAMIC FILTER	
		(CRYSTAL OSCILLATORS)	
X1	BD5R1024501	CRYSTAL OSCILLATOR	
X2	BD8R3276805	CRYSTAL OSCILLATOR	
X3	BD1R0399202	CRYSTAL OSCILLATOR	
		(TRANSFORMERS)	
T1	CLIP1200053	TRANSFORMER	
T3	CLIP1200070	TRANSFORMER	
T5	CLIP1200061	TRANSFORMER	
T6	CLIP1200088	TRANSFORMER	
		(OTHERS)	
E101	CK15HC12G10	RINGER	
E102	CGAP1200019	MICROPHONE	
E103	PQJT10183Z	CHARGE CONTACT	
BATT1	PQJP2D13Z	CONNECTOR	
VC1	CR00020RRT5	TRIMMER CAPACITOR	
		(RESISTORS)	
R1	ERJ3GEYJ331	330	
R2	ERJ3GEYJ153	15k	
R3	ERJ3GEYJ682	6.8k	
R5	ERJ3GEYJ103	10k	
R6	ERJ3GEYJ103	10k	
R8	ERJ3GEYJ224	220k	
R9	ERJ3GEYJ823	82k	
R10	ERJ3GEYJ823	82k	
R11	ERJ3GEYJ562	5.6k	
R12	ERJ3GEYJ224	220k	
R13	ERJ3GEYJ123	12k	
R14	ERJ3GEYJ153	15k	
R15	ERJ3GEY0R00	0	
R16	ERJ3GEYJ103	10k	
R17	ERJ3GEYJ512	5.1k	
R18	ERJ3GEYJ103	10k	
R19	ERJ3GEYJ472	4.7k	
R20	ERJ3GEYJ182	1.8k	
R21	ERJ3GEYJ823	82k	
R22	ERJ3GEYJ472	4.7k	
R23	ERJ3GEYJ473	47k	
R24	ERJ3GEYJ472	4.7k	
R25	ERJ3GEYJ563	56k	
R26	ERJ3GEYJ103	10k	
R28	ERJ3GEYJ124	120k	
R29	ERJ3GEYJ682	6.8k	
R30	ERJ3GEY0R00	0	

Ref. No.	Part No.	Part Name & Description	Remarks
R34	ERJ3GEYJ224	220k	
R35	ERJ3GEYJ473	47k	
R36	ERJ3GEYJ202	2k	
R37	ERJ3GEYJ102	1k	
R38	ERJ3GEY0R00	0	
R39	ERJ3GEYJ224	220k	
R40	ERJ3GEYJ330	33	
R41	ERJ3GEYJ683	68k	
R42	ERJ3GEYJ223	22k	
R43	ERJ3GEYJ104	100k	
R44	ERJ3GEYJ393	39k	
R45	ERJ3GEYJ104	100k	
R46	ERJ3GEYJ434	430k	
R47	ERJ3GEYJ222	2.2k	
R48	ERJ3GEYJ223	22k	
R49	ERJ3GEYJ473	47k	
R50	ERJ3GEYJ822	8.2k	
R51	ERJ3GEYJ272	2.7k	
R52	ERJ3GEYJ681	680	
R53	ERJ3GEYJ820	82	
R54	ERJ3GEYJ104	100k	
R55	ERJ3GEYJ390	39	
R56	ERJ3GEYJ222	2.2k	
R57	ERJ3GEYJ332	3.3k	
R58	ERJ3GEYJ470	47	
R59	ERJ3GEYJ222	2.2k	
R60	ERJ3GEYJ222	2.2k	
R61	ERJ3GEYJ331	330	
R62	ERJ3GEYJ222	2.2k	
R63	ERJ3GEYJ103	10k	
R64	ERJ3GEYJ103	10k	
R65	ERJ3GEYJ331	330	
R66	ERJ3GEYJ222	2.2k	
R67	ERJ3GEYJ222	2.2k	
R68	ERJ3GEYJ103	10k	
R69	ERJ3GEYJ222	2.2k	
R70	ERJ3GEYJ222	2.2k	
R72	ERJ3GEYJ105	1M	
R74	ERJ3GEYJ104	100k	
R75	ERJ3GEYJ104	100k	
R76	ERJ3GEYJ104	100k	
R77	ERJ3GEYJ103	10k	
R78	ERJ3GEYJ104	100k	
R79	ERJ3GEYJ105	1M	
R81	ERJ3GEYJ105	1M	
R82	ERJ3GEY0R00	0	
R83	ERJ3GEY0R00	0	
R84	ERJ3GEYJ105	1M	
R85	ERJ3GEYJ102	1k	
R86	ERJ3GEYJ104	100k	
R87	ERJ3GEYJ104	100k	
R91	ERJ3GEY0R00	0	
R93	ERJ3GEYJ103	10k	
R94	ERJ3GEYJ334	330k	
R95	ERJ3GEYJ393	39k	
R96	ERJ3GEY0R00	0	
R97	ERJ3GEYJ104	100k	
R98	ERJ3GEYJ475	4.7M	
R99	ERJ3GEYJ472	4.7k	
R101	ERJ3GEY0R00	0	
R103	ERJ3GEYJ105	1M	
R105	ERJ3GEYJ103	10k	
R106	ERJ3GEYJ151	150	
R107	ERJ3GEYJ222	2.2k	
R108	ERJ3GEYJ102	1k	
R109	ERJ3GEYJ102	1k	
R110	ERJ3GEYJ102	1k	
R111	ERJ3GEYJ102	1k	
R112	ERJ3GEYJ102	1k	
		(CAPACITORS)	
C1	ECEA1EK470	47	S
C2	ECUV1H473MDV	0.047	S
C3	ECUV1H390JCV	39p	

Ref. No.	Part No.	Part Name & Description	Remarks
C4	ECUV1H270JCV	27p	
C5	ECUV1C104ZFB	0.1	
C6	ECUV1H102KBV	0.001	
C7	ECUV1C104ZFB	0.1	
C8	ECUV1H473MDV	0.047	S
C9	ECUV1H103KBV	0.01	
C12	ECEA1HKA2R2	2.2	
C13	ECUV1H270JCV	27p	
C14	ECUV1H103KBV	0.01	
C15	ECEA1CKA100	10	
C16	ECUV1C473KBV	0.047	
C17	ECUV1H102KBV	0.001	
C18	ECEA1HKA2R2	2.2	
C21	ECUV1H223KBV	0.022	S
C22	ECUV1H390JCV	39p	
C23	ECUV1H102KBV	0.001	
C24	ECUV1H220JCV	22p	
C26	ECUV1H103KBV	0.01	
C27	ECUV1C104KBV	0.1	
C28	ECUV1H682KBV	0.0068	
C29	ECEA1HKA2R2	2.2	
C30	ECUV1C104KBV	0.1	
C31	ECUV1H103KBV	0.01	
C32	ECUV1C104KBV	0.1	
C33	ECUV1C104KBV	0.1	
C34	ECUV1H101JCV	100p	
C35	ECUV1H681JCV	680p	
C36	ECUV1H180JCV	18p	
C37	ECEA1HKA010E	1	
C38	ECUV1H101JCV	100p	
C39	ECUV1H151JCV	150p	
C40	ECUV1H103KBV	0.01	S
C41	ECUV1H220JCV	22p	
C42	ECEA1EK470	47	S
C43	ECEA1HKA2R2	2.2	
C44	ECUV1C105ZFB	1	
C45	ECUV1C683KBV	0.068	
C47	ECUV1H682KBV	0.0068	
C48	ECEA1EK470	47	S
C49	ECUV1H223KBV	0.022	S
C50	ECUV1H103KBV	0.01	S
C51	ECEA1CKA100	10	
C52	ECUV1H103KBV	0.01	S
C53	ECUV1H223KBV	0.022	S
C54	ECUV1H100DCV	10p	S
C55	ECUV1H103KBV	0.01	S
C56	ECUV1H010CCV	1p	
C57	ECUV1H150JCV	15p	
C58	ECUV1H103KBV	0.01	
C59	ECUV1H270JCV	27p	
C60	ECUV1H270JCV	27p	
C61	ECUV1C104ZFB	0.1	
C62	ECUV1H560JCV	56p	
C63	ECEA1CK101	100	S
C64	ECUV1H103KBV	0.01	S
C65	ECUV1H150JCV	15p	
C66	ECUV1H150JCV	15p	
C69	ECUV1C104ZFB	0.1	
C70	ECUV1H330JCV	33p	
C71	ECUV1H330JCV	33p	
C72	ECUV1C104ZFB	0.1	
C73	ECUV1C104ZFB	0.1	
C74	ECUV1H473MDV	0.047	S
C75	ECUV1H103KBV	0.01	
C76	ECUV1H471JCV	470p	
C77	ECUV1H471JCV	470p	
C78	ECUV1H103KBV	0.01	
C79	ECUV1H103KBV	0.01	
C80	ECUV1H103KBV	0.01	
C84	ECUV1C104ZFB	0.1	
C85	ECUV1C105ZFB	1	
C86	ECUV1C104ZFB	0.1	
C88	ECUV1C104ZFB	0.1	

Ref. No.	Part No.	Part Name & Description	Remarks
R102	ECUV1H333KBV	0.033	S

24.3. ACCESSORIES AND PACKING MATERIALS

Ref. No.	Part No.	Part Name & Description	Remarks
A1	PQJA10075Z	TEL CORD	
A2	PQLV16CEZ	AC ADAPTOR	△
A3	PQOX13178Z	INSTRUCTION BOOK	
A4	PQQW12509Z	LEAFLET	
P1	PQPP10090Z	POLY BAG (for Base Unit)	
P2	PQPP10091Z	POLY BAG (for Handset)	
P3	PQPP10092Z	POLY BAG	
P4	PQPK13522Z	GIFT BOX	

25 FOR SCHEMATIC DIAGRAM

25.1. Base Unit (SCHEMATIC DIAGRAM (Base Unit))

1. DC voltage measurements are taken with an oscilloscope or a tester with a ground.
2. The schematic diagrams and circuit board may be modified at any time with the development of new technology.

Important Safety Notice:

Components identified by \triangle mark have special characteristics important for safety. When replacing any of these components, use only the manufacturer's specified parts.

25.2. Handset (SCHEMATIC DIAGRAM (Handset))

1. DC voltage measurements are taken with an oscilloscope or a tester with a ground.
2. The schematic diagrams and circuit board may be modified at any time with the development of new technology.

26 SCHEMATIC DIAGRAM (Base Unit)

26.1. Base Unit

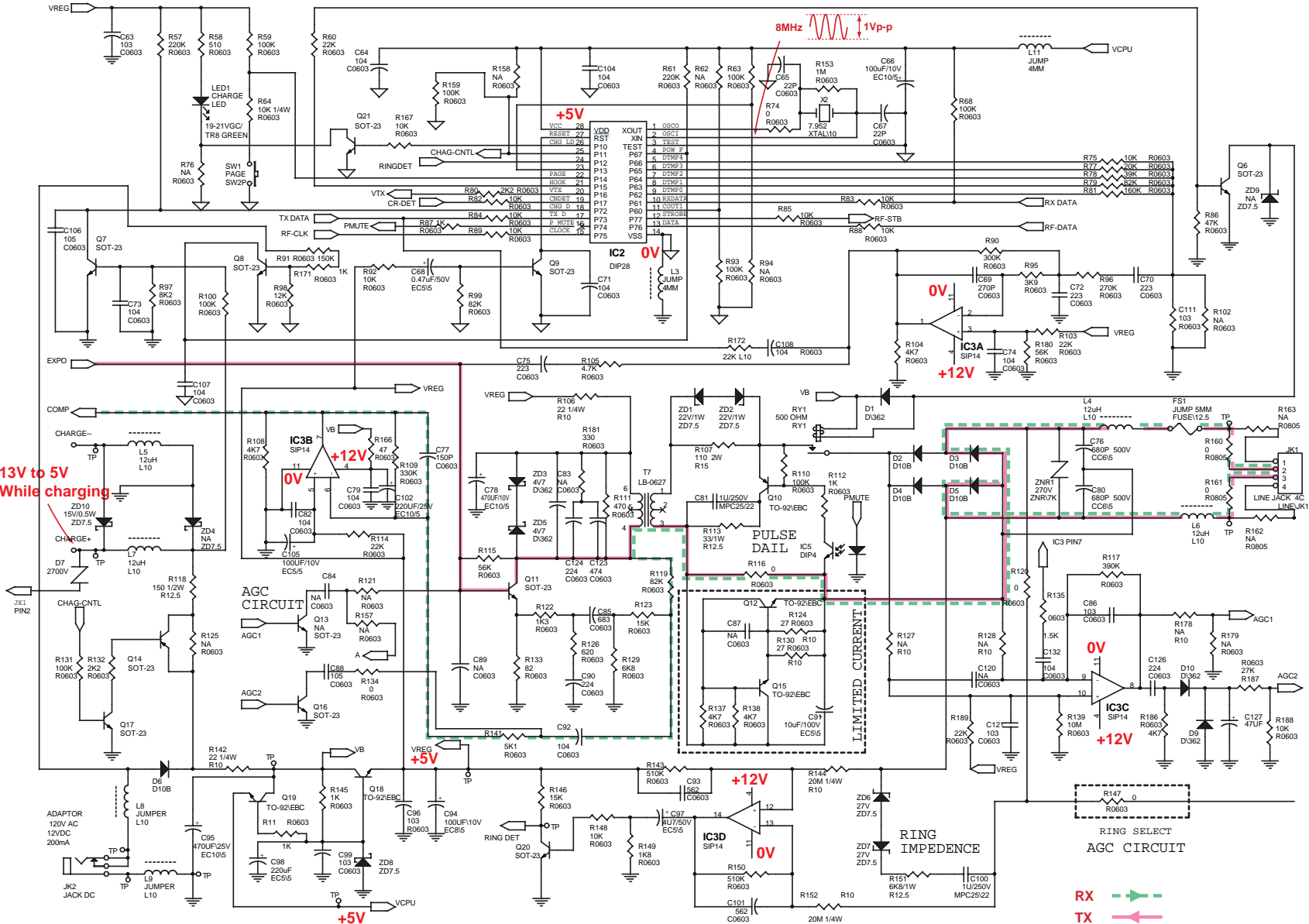

KX-TC1205RUB/W/S/F SCHEMATIC DIAGRAM (Base Unit)

KX-TC1205RUB / KX-TC1205R UW / KX-TC1205RUS / KX-TC1205RUF

26.2. RF Unit (Base Unit)

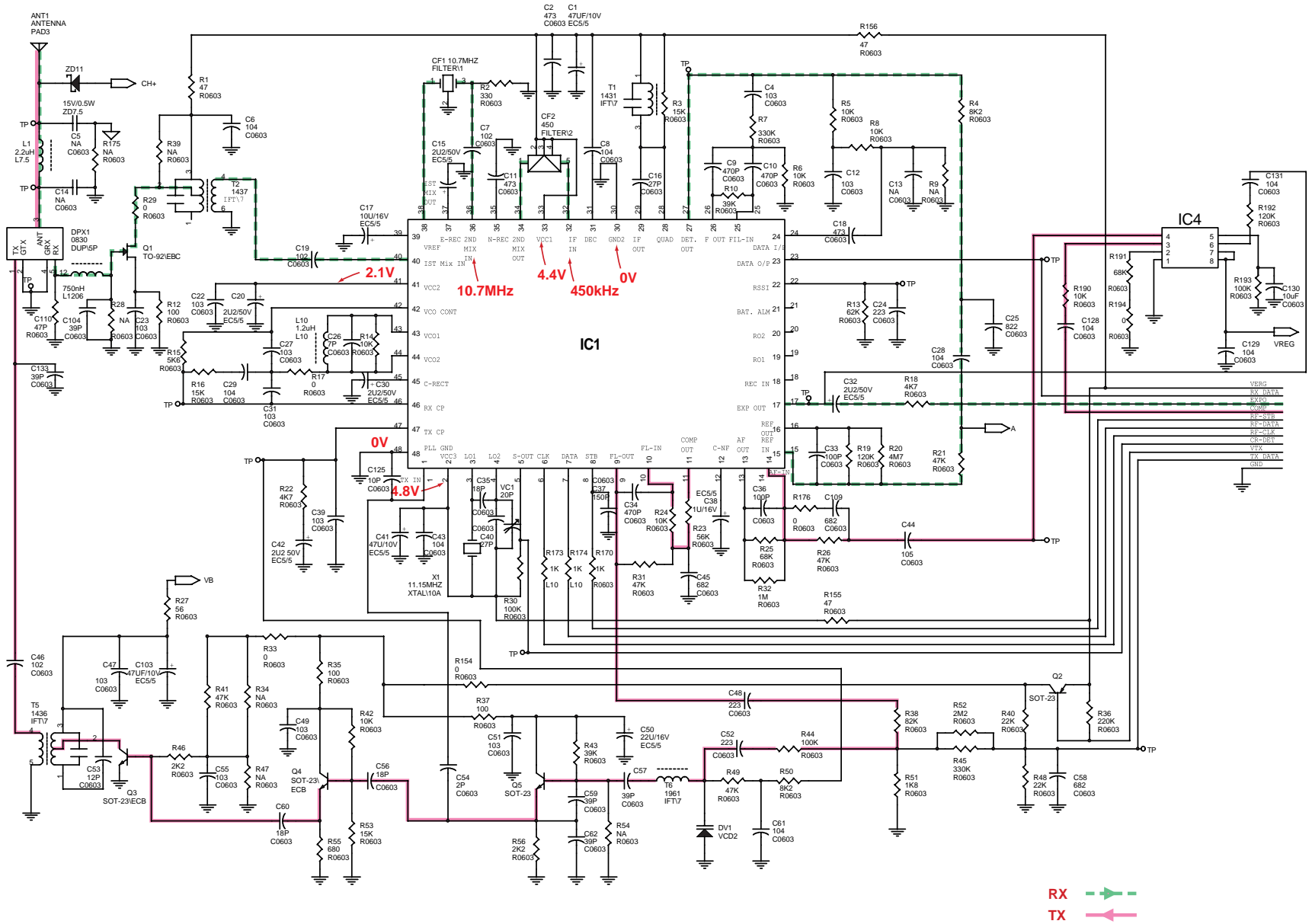

KX-TC1205RUB/W/S/F SCHEMATIC DIAGRAM (RF Unit (Base Unit))

27 SCHEMATIC DIAGRAM (Handset)

27.1. Handset

62

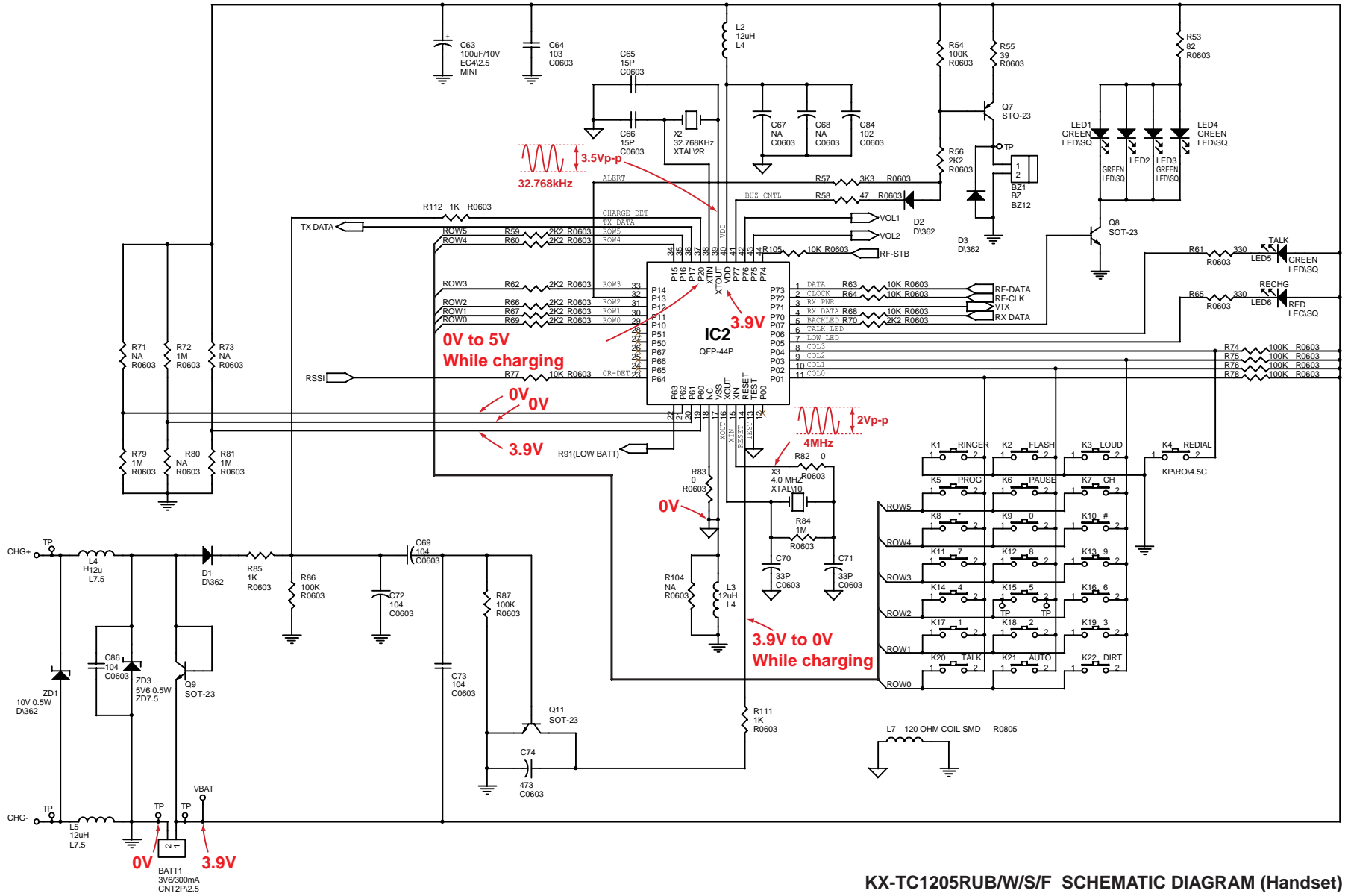

KX-TC1205RUB/W/S/F SCHEMATIC DIAGRAM (Handset)

27.2. RF Unit (Handset)

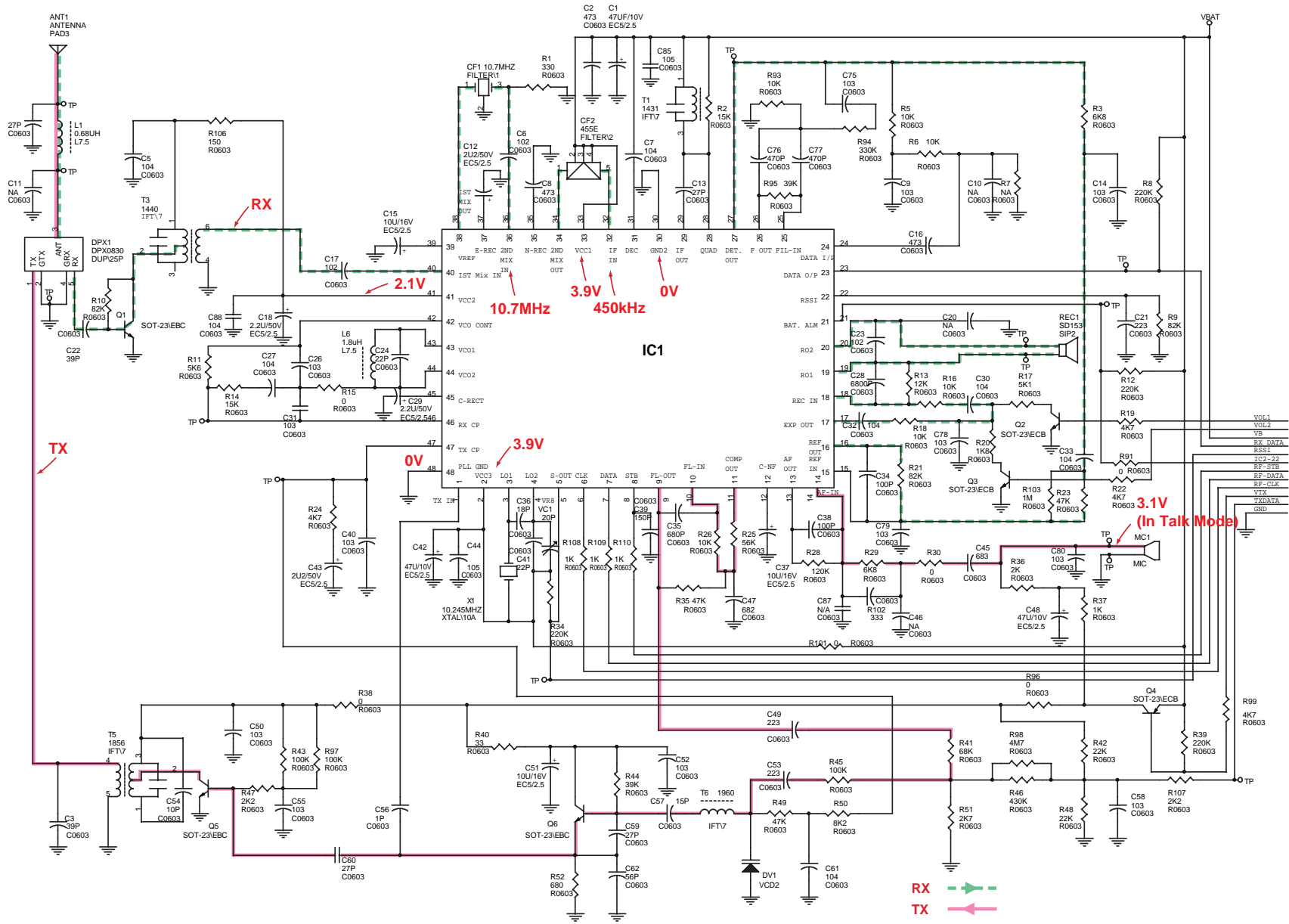

KX-TC1205RUB/W/S/F SCHEMATIC DIAGRAM (Handset (RF Unit))

28 CIRCUIT BOARD (Base Unit)

28.1. Component View

KX-TC1205RUB / KX-TC1205RUW / KX-TC1205RUS / KX-TC1205RUF

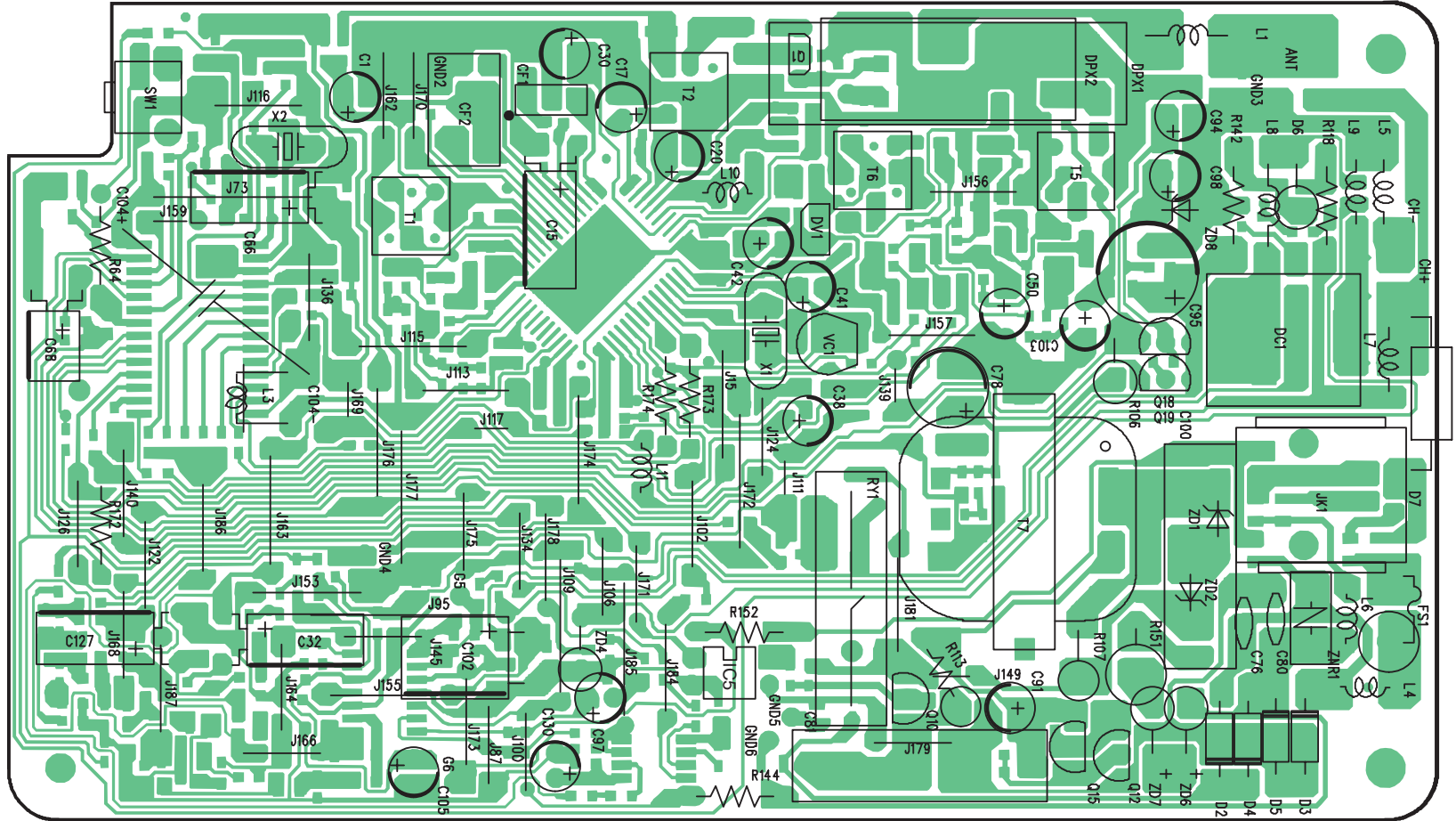

KX-TC1205RUB/W/S/F CIRCUIT BOARD (Component View (Base Unit))

28.2. Flow Solder Side View

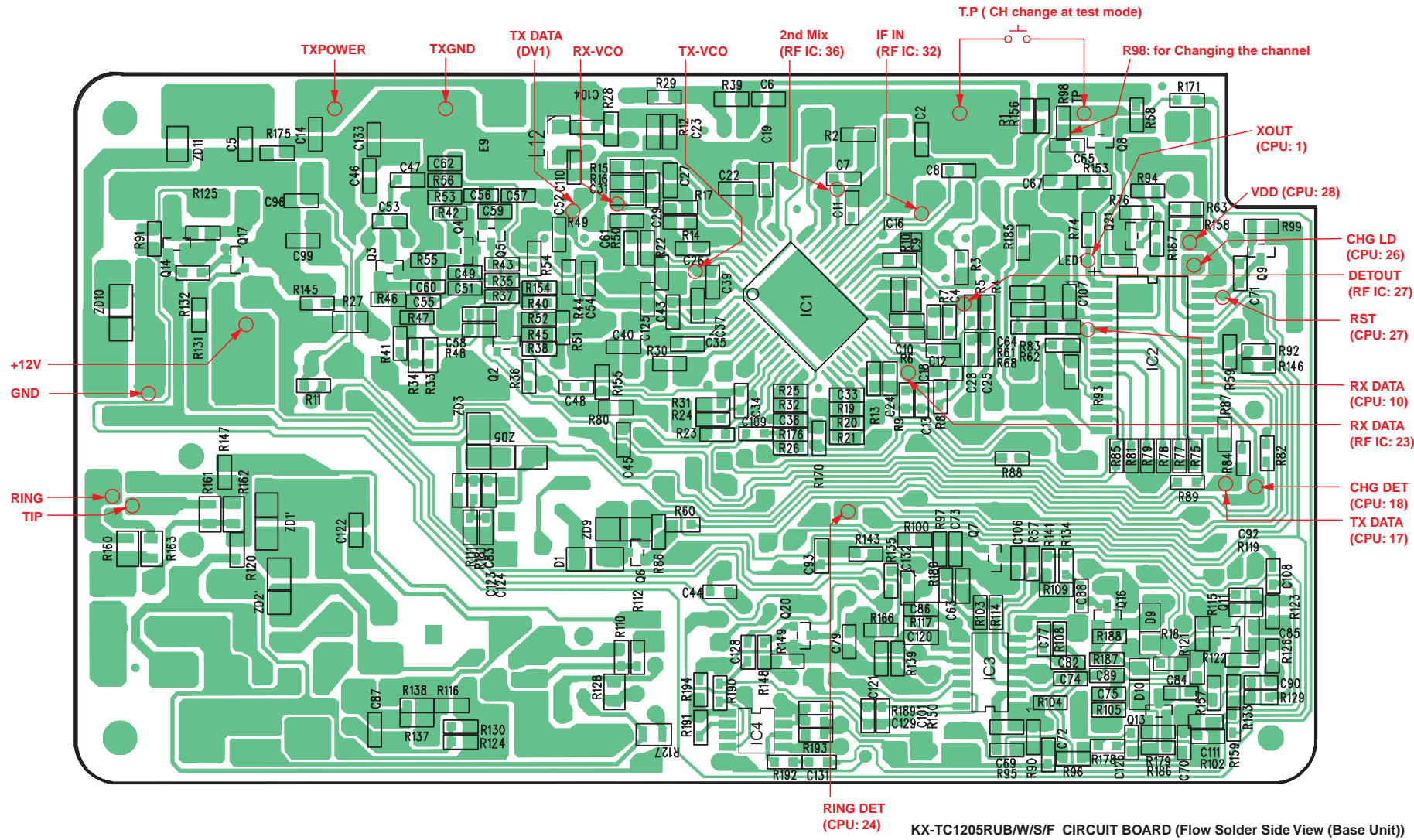

29 CIRCUIT BOARD (Handset)

29.1. Component View

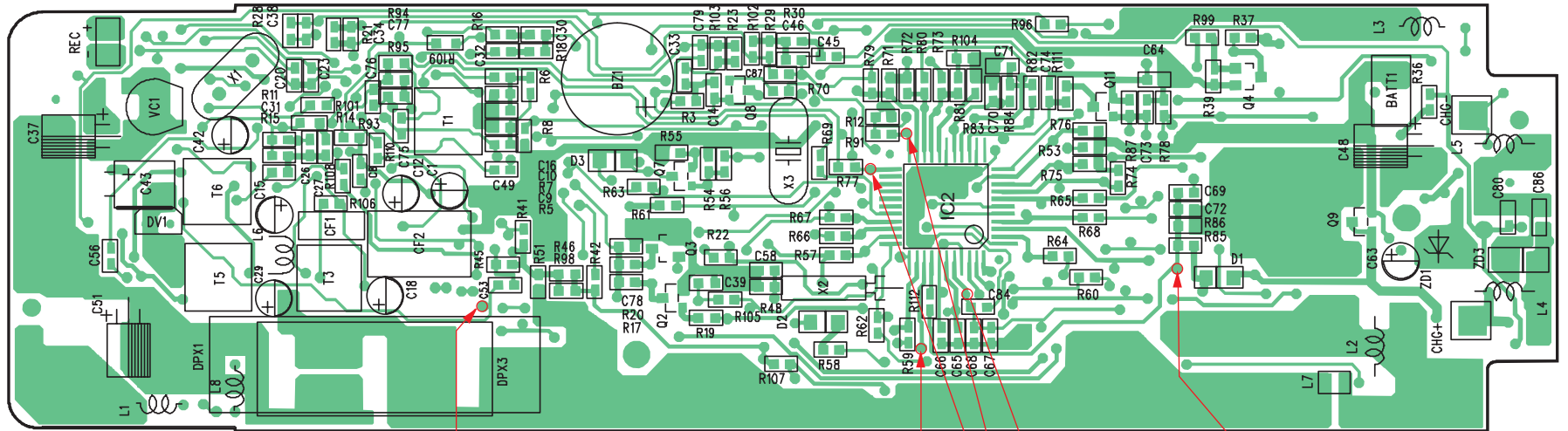

TX DATA (DV1)

TX DATA (CPU: 36)

VDD (CPU: 40)

(A) Battery Low

(G) Noise Squelch

CHG DET (CPU: 37)

KX-TC1205RUB/W/S/F CIRCUIT BOARD (Component View (Handset))

29.2. Flow Solder Side View

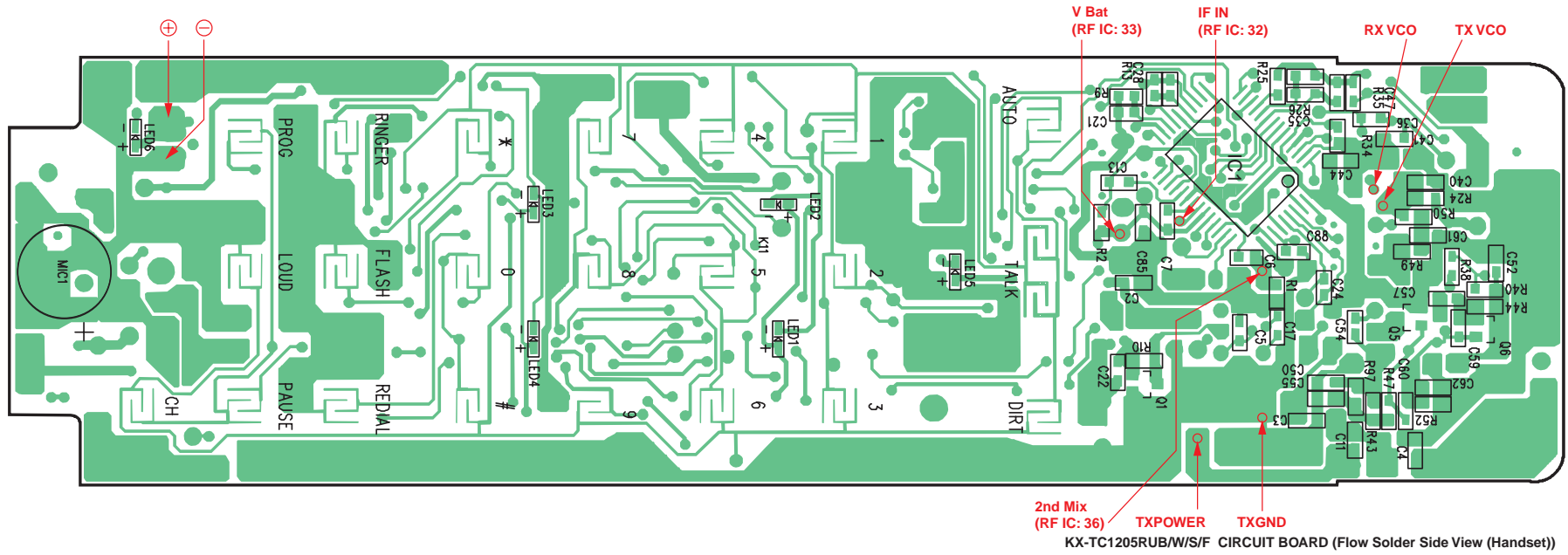

I
KXTC1205RUB
KXTC1205RUW
KXTC1205RUS
KXTC1205RUF