

The home of the turntable

THE VINYL ENGINE®

For more turntable manuals and setup information
please visit www.vinylengine.com

MICRO SEIKI®

TURNTABLE SYSTEM

DDX-1000

SERVICE MANUAL

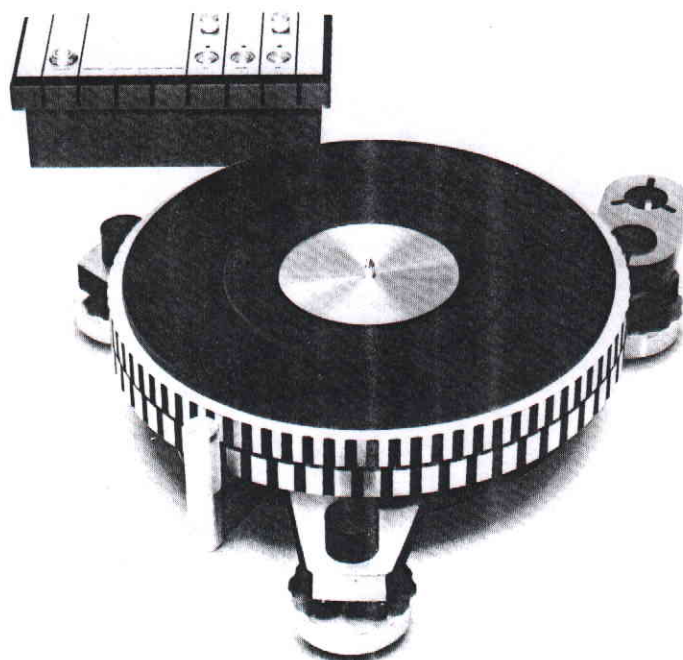

CONTENTS

1. PARTS NOMENCLATURE & SPECIFICATIONS	2
2. REPLACEMENT	
TURNTABLE UNIT	
MOTOR REPLACEMENT	3
NEON TUBE REPLACEMENT	3
POWER SUPPLY CIRCUIT BOARD REPLACEMENT	4
FOOT ASSEMBLY REPLACEMENT	4
CONTROL UNIT	
FUSE REPLACEMENT	5
CONTROL CIRCUIT BOARD REPLACEMENT	5
VARIABLE RESISTOR REPLACEMENT	5
SPEED SELECTION SWITCH REPLACEMENT	5
POWER SWITCH REPLACEMENT	6
3. ADJUSTMENTS	
FINE SPEED ADJUSTMENT FOR TURNTABLE SPEEDS	6
CHECK & ADJUSTMENT OF NEON STROBE LAMP OSILLATOR	7
4. PRINTED CIRCUIT BOARD	8
PARTS LIST FOR PRINTED CIRCUIT BOARD	9
5. EXPLODED VIEW(TURNTABLE UNIT)	10
PARTS LIST FOR EXPLODED VIEW	11
6. EXPLODED VIEW(CONTROL UNIT)	12
PARTS LIST FOR EXPLODED VIEW	13
7. SCHEMATIC DIAGRAM	14 · 15
8. PACKING FOR SHIPMENT	16

PARTS NOMENCLATURE

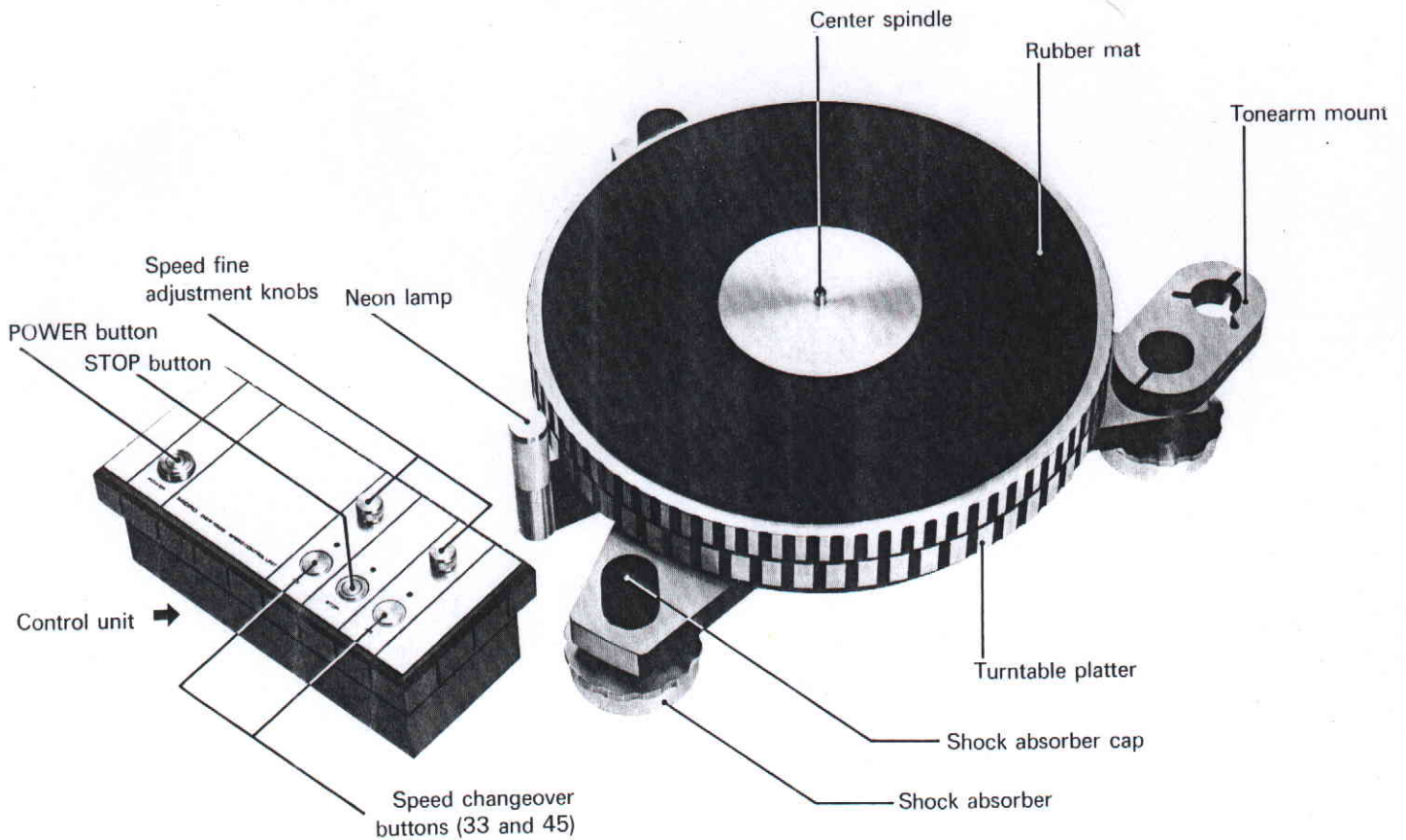

DDX-1000 Specifications

Drive System	Direct drive, frequency governed DC servo motor
Speeds	33-1/3 and 45 rpm
Platter	Aluminium alloy, 31 cm, 2 kg. (12.2 in. 4.4 lbs.) 330 kg·cm ² moment of inertia (113 lbs·in ²)
Power Consumption	117V, 5W
Wow and Flutter	less than 0.025%
S/N Ratio	more than 63 dB
Speed adjustment range.....	± 6% of the rated speed
Dimensions (W) × (D) × (H)	444 × 444 × 125 mm (174.8 × 174.8 × 49.21 in.)
Weight	10 kg (22 lbs.) without control unit

REPLACEMENT

Turntable Unit

• Motor Replacement

1. Remove the turntable platter.
2. Remove the 3 bolts retaining the motor cover to the motor frame. (Photo 2)

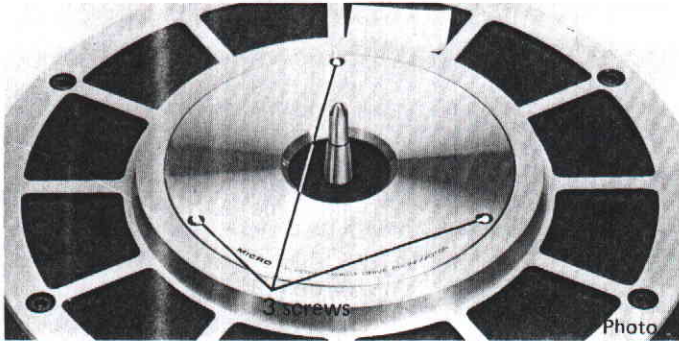

3. Remove the 6 screws retaining the bottom cover to the motor frame.
4. Remove the 3 screws securing the motor to the motor frame. (Photo 3)

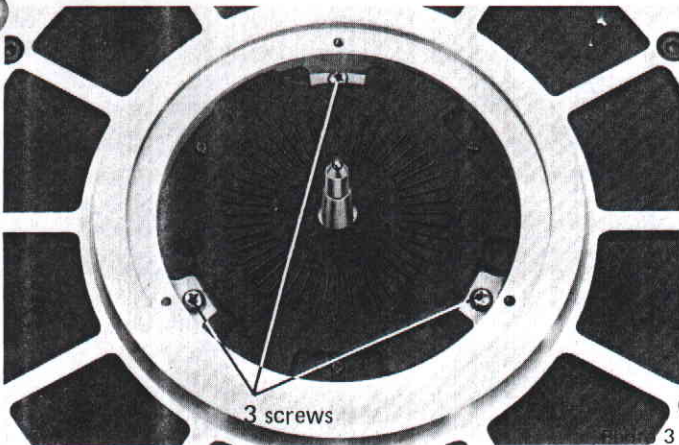

5. Remove the 2 screws retaining the mounting plate to the motor frame. (Photo 4)

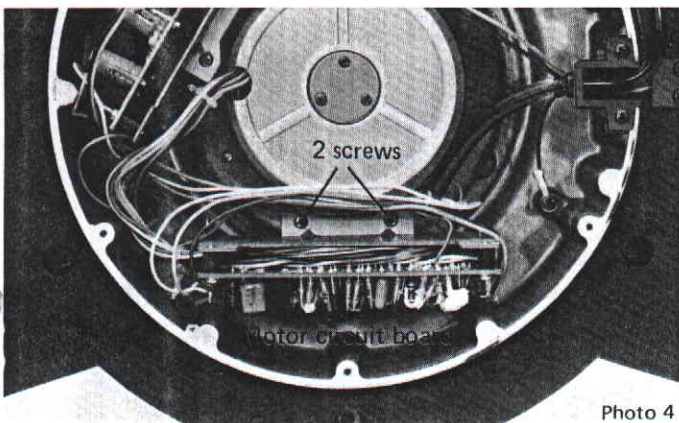

Photo 4

6. Remove the 4 screws retaining the motor circuit board to the mounting plate. (Photo 5)

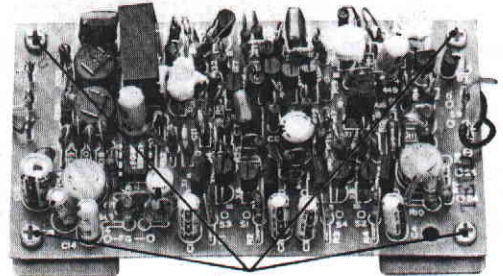
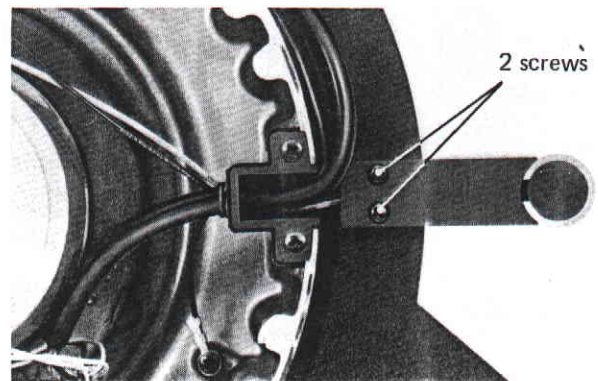

Photo 5

7. Unsolder the lead wires from the motor circuit board.
8. After replacing the motor assembly, adjust the turntable speeds.

• Neon Tube Replacement

1. Remove the 6 screws retaining the bottom cover to the motor frame.
2. Unsolder the 2 lead wires (red and black).
3. Remove the 2 screws retaining the holder bracket to the motor frame. (Photo 6)



4. Remove the 2 screws retaining the neon tube holder. (Photo 7)

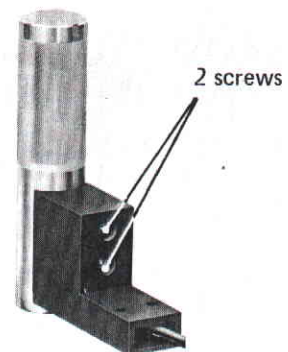
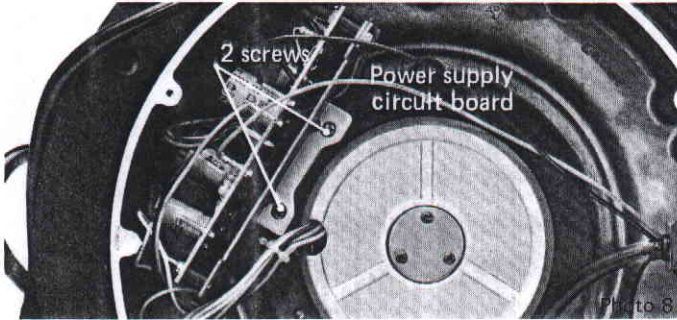

Photo 7

- Power Supply Circuit Board Replacement

1. Remove the 6 screws retaining the bottom cover to the motor frame.
2. Remove the 2 screws retaining the mounting plate to the motor frame.(Photo 8)



3. Remove the 3 screws retaining the circuit board to the mounting plate.(Photo 9)

polycarbonate screw

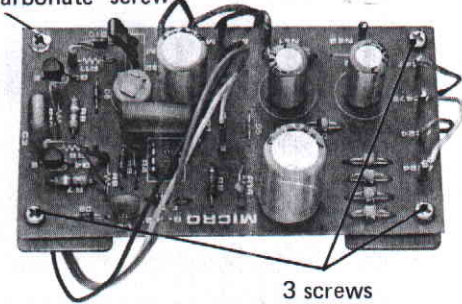

3 screws

Photo 9

4. Remove the nut retaining the transistor to the backside of the mounting plate.
5. Remove the polycarbonate screw.
6. Unsolder the lead wires from the circuit board.

Note: When replacing the board and remounting the transistor to the backside of the mounting plate, avoid overtightening the polycarbonate screw as you may damage its threading.

- Foot Assembly Replacement

1. Remove the screw retaining the cushion rubber to the foot assembly.(Photo 10)

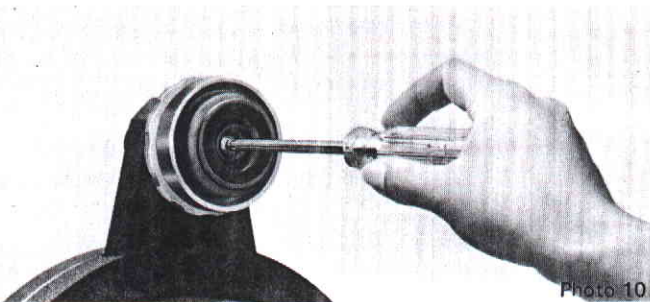

Photo 10

2. Align the holes of the height adjustment ring with those of the cushion cover.(Photo 11)

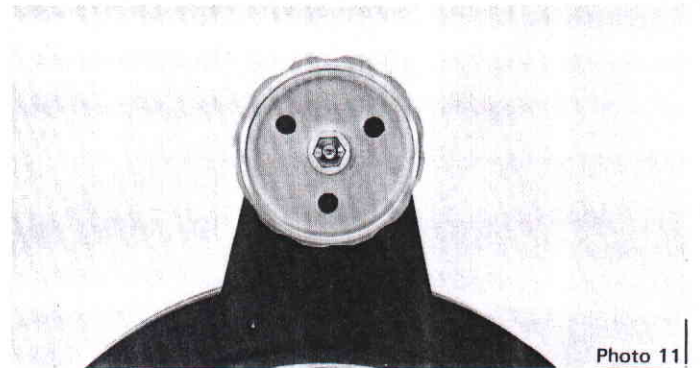

Photo 11

3. Remove the 3 screws retaining the foot assembly to the main frame.(Photo 12)

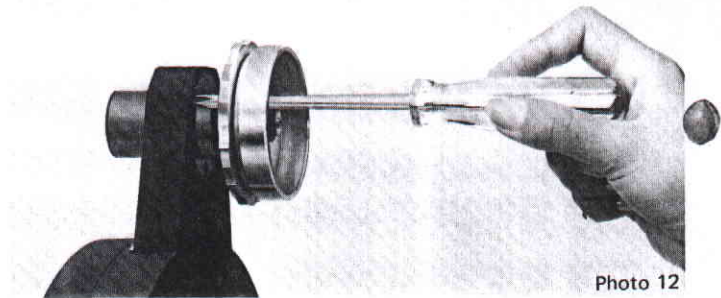
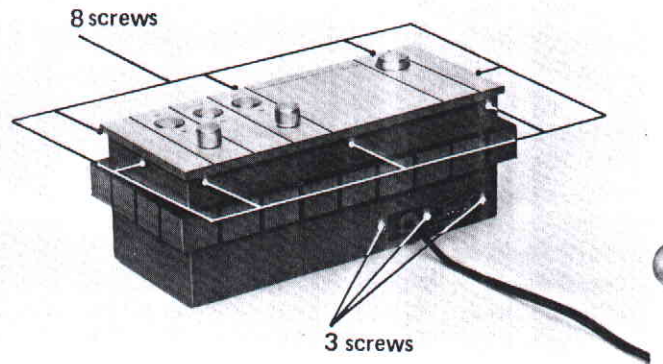

Photo 12

Control Unit

For the replacement of the components contained in the control unit, remove the case in accordance with the following procedure.

1. Disconnect the connector plug.
2. Extend the protector which is stuck to the case by adhesive tape, and shift it down to expose the 8 screw heads.
3. Remove the 8 screws retaining the sub-chassis to the case. (Photo 13)
4. Remove the 3 screws securing the connector mounting plate to the case.(Photo 13)



3 screws

Photo 13

- Fuse Replacement

The fuse is mounted on the circuit board.(Photo 14)

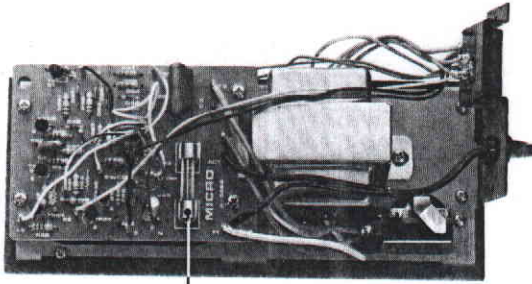

Fuse

Photo 14

- Control Circuit Board Replacement

1. Unsolder the lead wires from the circuit board.
2. Remove the 4 screws retaining the circuit board to the mounting spacer studs.(Photo 15)

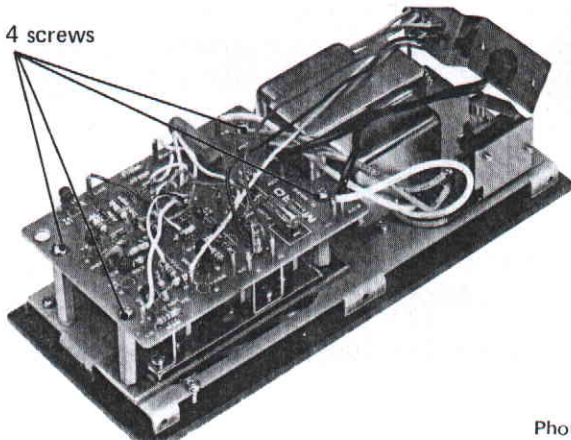

Photo 15

- Variable Resistor Replacement

1. To remove the speed adjustment knobs, which are push-on types to variable resistor knurled shafts, insert the minus screwdriver to the bottom surfaces of the knobs and push up gently. (Fig. 1)

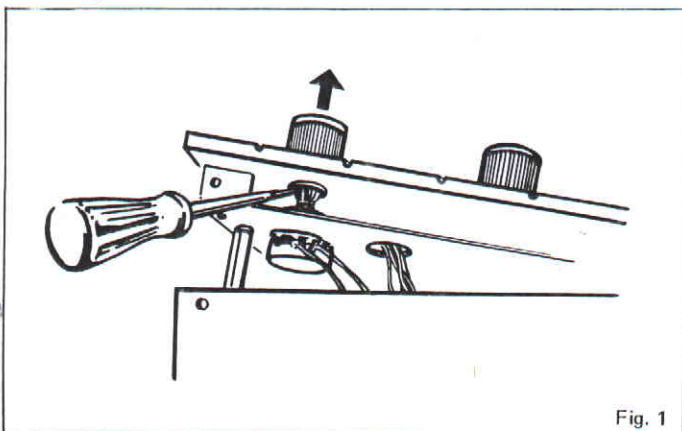

Fig. 1

2. Remove the 4 screws retaining the circuit board to the mounting spacer studs. (Photo 15)
3. Remove the 2 screws securing the power transformer to the sub-chassis. (Photo 16)

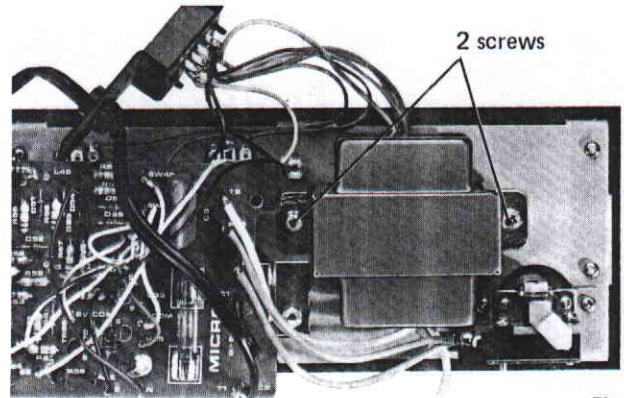

Photo 16

4. Remove the 5 screws securing the sub-chassis to the front panel.(Photo 17)

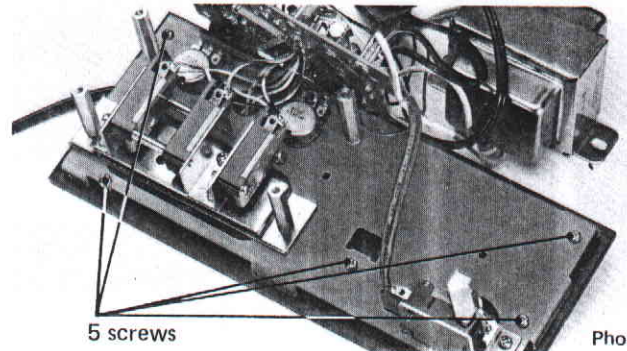

Photo 17

5. Unsolder the lead wires.

- Speed Selection Switch Replacement

1. Remove the 4 screws retaining the circuit board to the mounting spacer studs.(Photo 15)
2. Remove the 2 mounting spacer studs secured to the sub-chassis.(Photo 18)

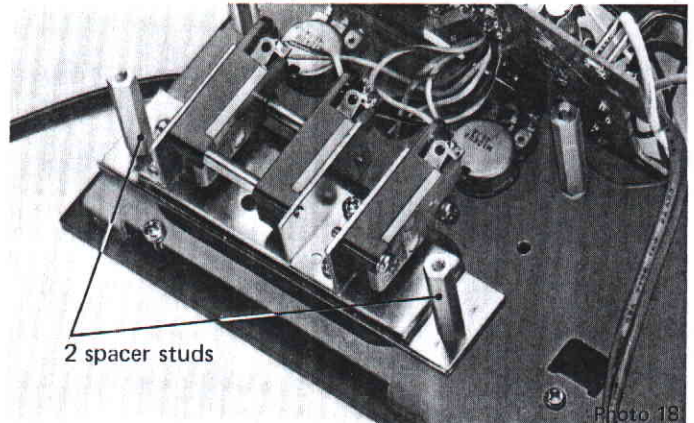
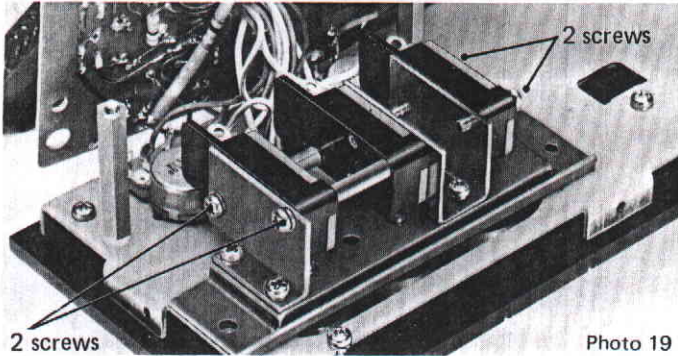

Photo 18

ADJUSTMENTS

3. Remove the 2 screws retaining the micro switch to the switch holder. (Photo 19)



● Power Switch Replacement

1. Remove the 2 screws retaining the switch mounting to the sub-chassis. (Photo 20)

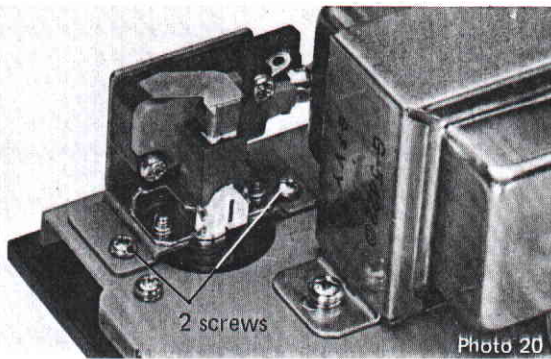

2. Remove the 2 screws retaining the push switch to the mounting plate. (Photo 21)
3. Remove the 2 screws retaining the micro switch to the mounting plate. (Photo 21)

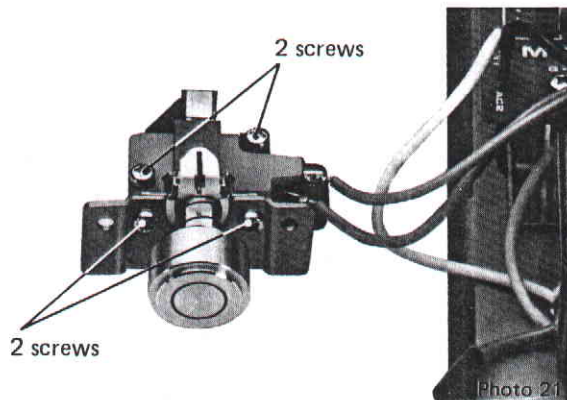

● Fine Speed Adjustment for Turntable Speeds

When adjustment of the speed fine adjustment knob does not give a satisfactory speed, adjust the motor in accordance with the following procedure.

1. Remove the 6 screws retaining the bottom cover to the motor frame.
2. Set the speed fine adjustment knobs located on the control unit to the middle position.
3. Push the power button and then one of the speed change over button.
4. While watching the stroboscope markings on the turntable platter, adjust the variable resistor mounted on the motor circuit board for appropriate static display of the strobe. (Photo 22)

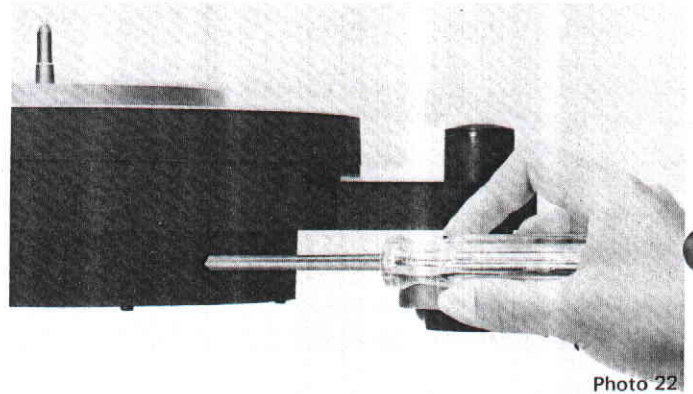

5. Alternate switching between 33 and 45 rpm speeds while making adjustment. Make sure that both speeds are correct. (Fig 2)

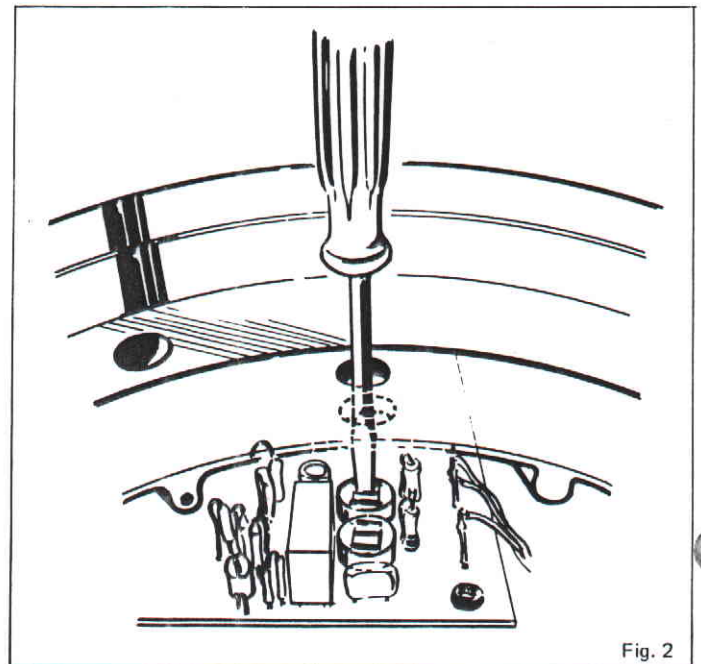

● Check & Adjustment of Neon Strobe Lamp Oscillator

The neon lamp is driven by a built-in 45Hz oscillator with a frequency fluctuation of less than 0.03%. The DDX-1000, therefore, does not rely on an external 60Hz or 50Hz frequency from the power line.

Check and adjustment of strobe lamp oscillator are as follows: (see Fig 3)

1. Remove the 6 screws retaining the bottom cover to the motor frame.
2. Remove the 2 screws retaining the mounting plate to the motor frame.
3. Unsolder the red colored lead wire from the M⁺ terminal on the power supply circuit board.
4. Connect a lead wire between the M⁻ terminal on the circuit board and the ⊖ terminals (grounded) of the frequency counter and the oscilloscope.

5. Connect a lead wire between the collector of TR4 (T.P.) and the ⊕ terminal of the oscilloscope and frequency counter.
6. Check that the frequency range is from 22.200 ms to 22.244 ms (center 22.222 ms).
7. Check the wave-form characteristic simultaneously.
8. When the frequency counter does not show the above frequency, adjust the variable resistor on the circuit board.

Note: When measuring a very low frequency such as 45Hz with a frequency counter more accurately, it is recommended to measure the period rather than frequency. For this purpose, please use the frequency counter, measurable the period.

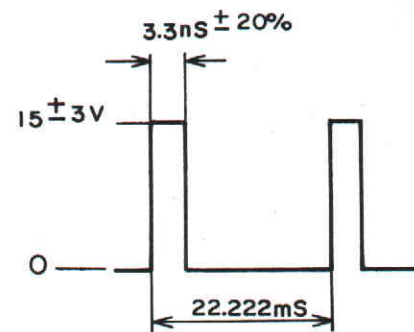
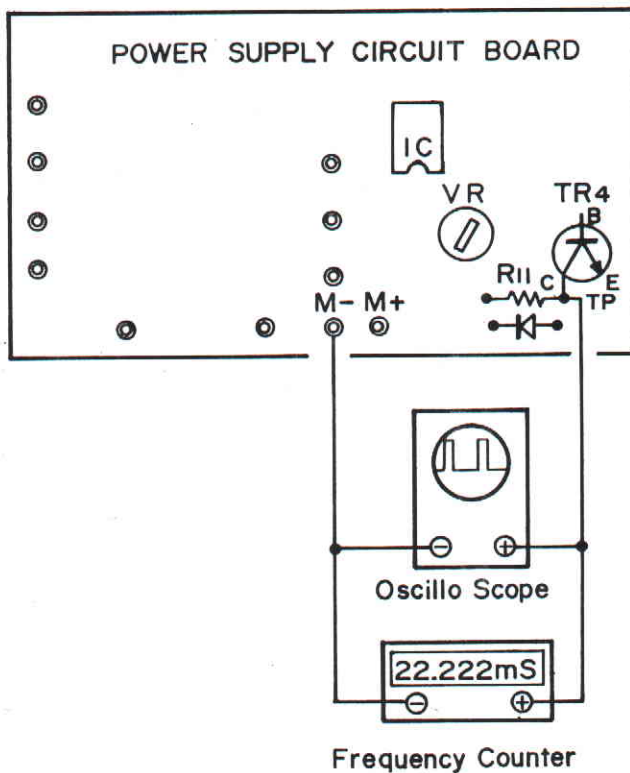
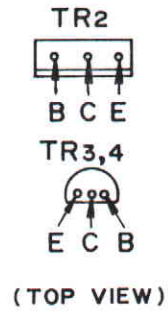
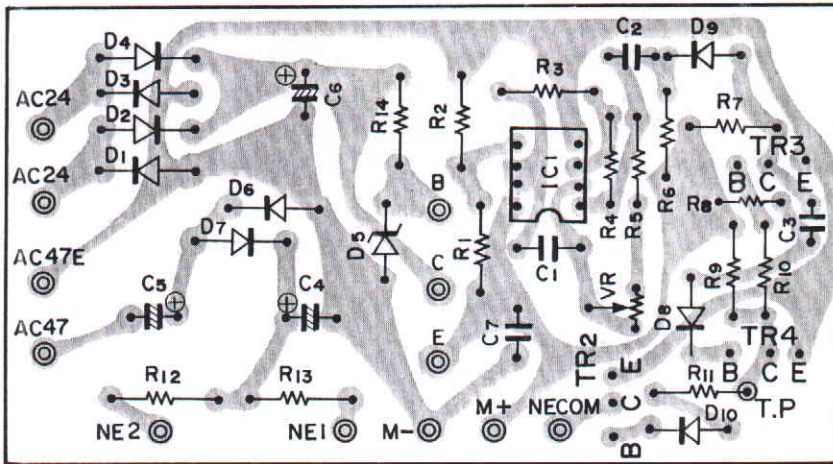

Fig. 3

PRINTED CIRCUIT BOARD

POWER SUPPLY PRINTED CIRCUIT BOARD ASS'Y
(TOP VIEW)



CONTROL UNIT PRINTED CIRCUIT BOARD ASS'Y
(TOP VIEW)

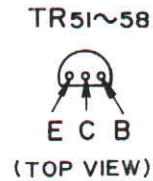
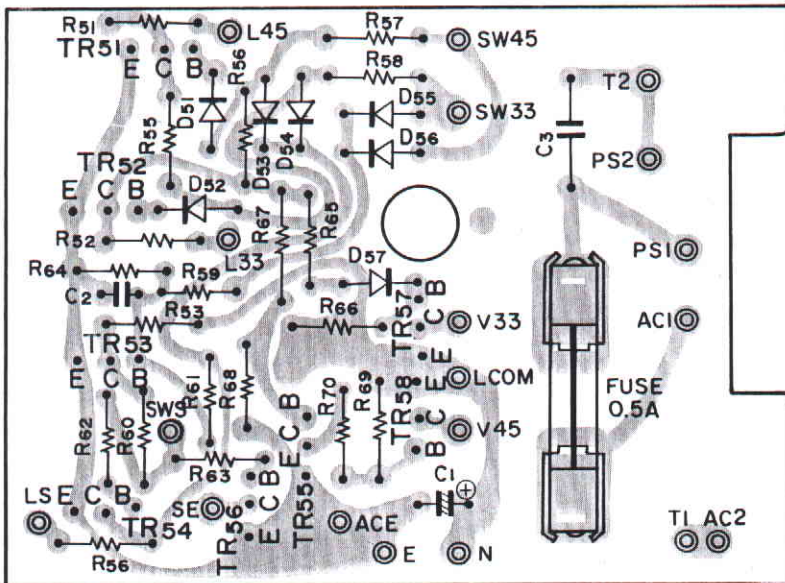

LED PRINTED CIRCUIT BOARD ASS'Y
(TOP VIEW)

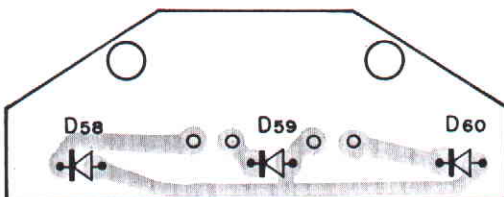

CIRCUIT REF. No.	PARTS No.	DESCRIPTION
D58-D60	00031-06	TLR 102 (LED)

PARTS LIST FOR PRINTED CIRCUIT BOARD

POWER SUPPLY UNIT

REF. NO.	PARTS NO.	DESCRIPTION
	44039-03	PC Bd. Ass'y POWER SUPPLY UNIT
	44037-10	PC Bd. (Only)
IC		
	00003-04	RC4558 (DN) or (NB)
TRANSISTORS		
Tr3-Tr4	00004-09	2SC 372 (Y) or 2SC 945
Tr2	00005-03	2SC 983 (O)
Tr1	00006-08	2SD 325 or 2SD 313
DIODES		
D1-D4	00007-02	V06B
D6,D7	00008-07	V06E
D8-D10	00010-04	ISI 555
D5	00009-01	Zener, WZ-240
VARIABLE RESISTOR		
VR	00027-00	SR19R 22kΩ (B)
RESISTORS		
R1,R2	00011-09	1.5kΩ ¼ W

REF. NO.	PARTS NO.	DESCRIPTION
R6	00013-08	33kΩ ¼ W
R7,R9	00012-03	3.9kΩ ¼ W
R8,R10	00014-02	100kΩ ¼ W
R11	00015-07	6.8kΩ ¼ W
R14	00016-01	1.2kΩ ¼ W
R12	00017-06	2.2kΩ ½ W
R3	00019-05	2.4kΩ ¼ W ±1%
R4	00020-08	10kΩ ¼ W ±1%
R5	00018-00	120kΩ ¼ W ±1%
CAPACITORS		
C1	00021-02	0.22μF 50WV
C2	00022-07	0.001μF 50WV
C3	00023-01	0.047μF 50WV
C4,C5	00026-05	10μF 100WV
C6	00024-06	330μF 35WV
C7	00025-00	220μF 35WV

CONTROL UNIT

REF. NO.	PARTS NO.	DESCRIPTION
	30764-18	RC Bd. Ass'y CONTROL UNIT
	30761-40	RC Bd. (Only) CONTROL UNIT
	44364-00	LED PC Bd. Only
	5005-08	Fuse Holder SN-5051
	5004-03	Fuse 0.5A
TRANSISTORS		
Tr51-Tr56	00033-05	2SC 372 (Y)
Tr57-Tr58	00034-00	2SA 495 (Y)
DIODES		
D51-D56	00035-04	ISI 588
D57	00036-09	Zener, WZ-050
D58-D60	00031-06	TLR 102 (LED)
RESISTORS		
R51-R54	00037-03	5.6kΩ ¼ W

REF. NO.	PARTS NO.	DESCRIPTION
R69	00037-03	5.6kΩ ¼ W
R55,R56	00038-08	150kΩ ¼ W
R61,R64	00038-08	150kΩ ¼ W
R57,R58	00039-02	22kΩ ¼ W
R59,R65	00040-05	39kΩ ¼ W
R60	00041-00	100kΩ ¼ W
R62,R63	00042-04	47kΩ ¼ W
R66,R70	00043-09	15kΩ ¼ W
R67	00048-01	220kΩ ¼ W
R71-R73	00049-06	10kΩ ¼ W
CAPACITORS		
C1	00045-04	10μF 25WV
C2	00044-03	0.0068μF 50WV
C3	00071-00	0.01μF 250V

EXPLODED VIEW (TURNTABLE UNIT)

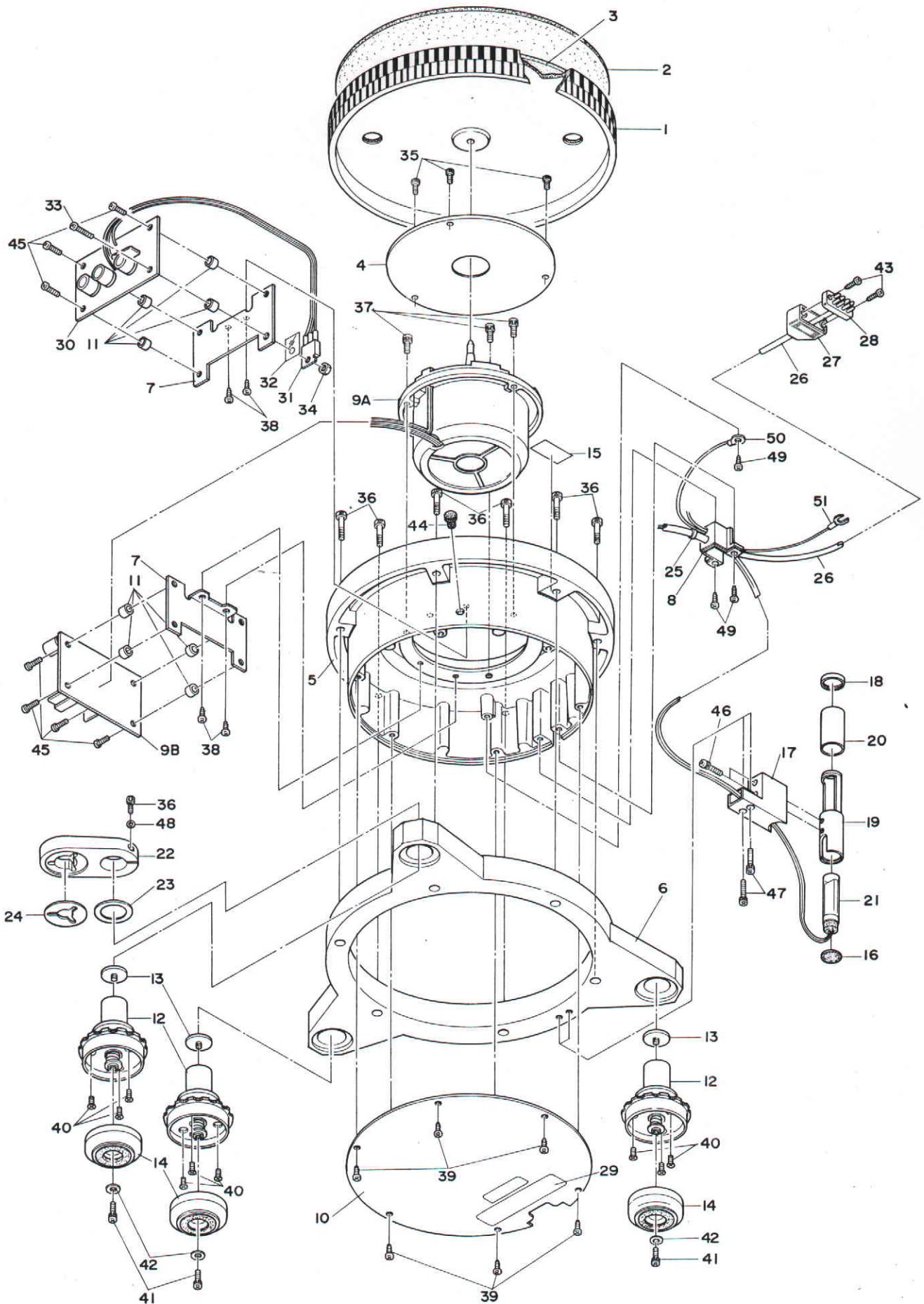

PARTS LIST FOR EXPLODED VIEW

TURNTABLE UNIT

REF. NO.	PARTS NO.	DESCRIPTION	REF. NO.	PARTS NO.	DESCRIPTION
1	20493-20	Turntable platter	41	60020-03	⊕ Binding screw M3 × 5
2	44143-02	Rubber mat (A)	42	60021-08	Washer $\phi 3 \times \phi 8 \times 1t$
3	44145-17	Rubber mat (B)	43	60023-07	⊕ Pan head tapping screw $\phi 2.6 \times 10$ ⊕
4	30849-00	Motor cover	44	43583-06	Rubber plug
5	10205-41	Motor frame	45		⊕ Pan head tapping screw M3 × 10
6	10212-41	Main frame	46	60028-00	⊕ Pan head screw M3 × 20
7	44021-30	Circuit board mounting plate	47	60029-04	⊕ Pan head screw M3 × 15
8	30787-19	Cord bushing	48	60030-07	Washer $\phi 5 \times \phi 10 \times 0.5t$
9A	00001-15	Motor M922C	49	60025-06	⊕ Binding tapping screw $\phi 3 \times 8$
9B		Motor circuit board	50	60039-08	Oval lug 3 ϕ
10		Bottom cover	51		Forked lug
11	42843-08	8 mm Spacer			
12	44184-22	Foot pole ass'y			
13	44177-22	Pole cap			
14	44132-04	Rubber cushion ass'y			
15	43806-09	Caution label			
16	44171-04	Bottom cap			
17	30786-20	Neon tube holder bracket			
18	44029-15	Holder cap			
19	44165-20	Neon tube holder			
20	44030-65	Acrylic ring			
21	00002-00	Neon tube NL77LA			
22	44453-04	Arm mount			
23	44098-16	Mount spacer			
24	444170-00	Retainer washer			
25					
26	44420-00	Eight-core cable			
27	30774-12	Connector cover			
28	00028-04	Connector MC8F			
29	44407-04	Specification seal			
30		Power supply circuit board ass'y			
31	00006-08	Transistor 2SD-325 or 313			
32		Insulator sheet			
33		Polycarbonate screw M3 × 15			
34	60036-04	Nut M3			
35	60014-08	Hexagonal hall head M3 × 5 bolt ⊕ (Black colored)			
36	60015-02	Hexagonal hall head M5 × 25 bolt ⊕			
37	60016-07	⊕ Pan head screw M4 × 15			
38	60017-01	⊕ Pan head tapping screw $\phi 3 \times 5$			
39	60018-06	⊕ Binding tapping screw $\phi 3 \times 5$ ⊕			
40	60019-00	⊕ Countersunk screw M3 × 10 ⊕			

EXPLODED VIEW (CONTROL UNIT)

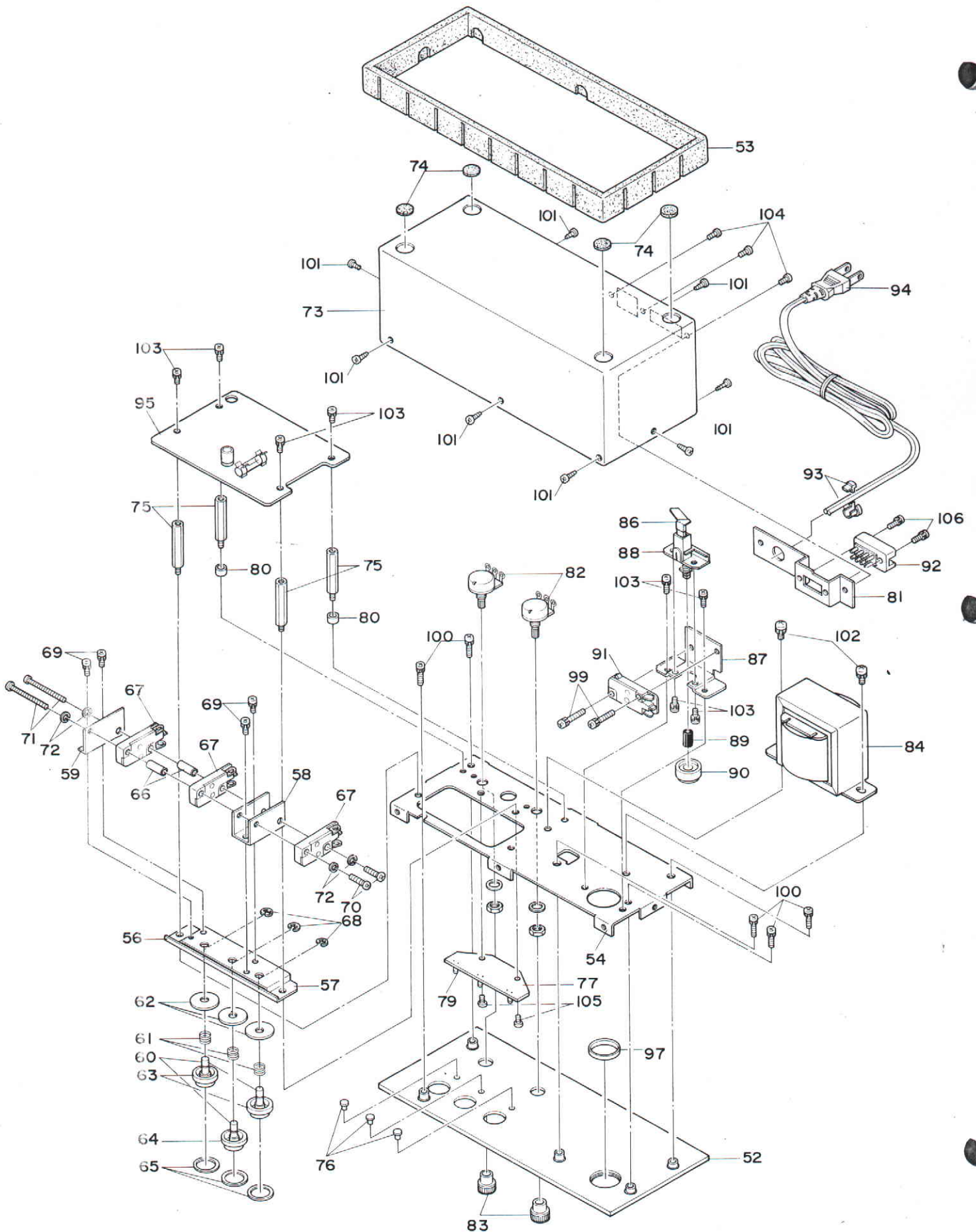

PARTS LIST FOR EXPLODED VIEW

CONTROL UNIT

REF. NO.	PARTS NO.	DESCRIPTION	REF. NO.	PARTS NO.	DESCRIPTION
52	30756-40	Front panel	93	50001-00	Cord bushing Bv3270 (Small)
53	30759-22	Protector	94	00081-04	AC Cord
54	30793-14	Sub-chassis	95	30764-18	Control circuit board ass'y
55	30781-06	Switching mechanism ass'y	96	30761-40	Control circuit board
56	43047-06	Rod holder (A)	97	44138-01	Button guide ring
57	43052-07	Rod holder (B)	98	60006-03	⊕ Pan head screw M3 × 6
58	30546-09	Switch holder	99	60029-04	⊕ Pan head screw M3 × 15
59	43040-04	Switch mounting angle bracket	100	60033-00	⊕ Pan head screw M3 × 12
60	43051-02	Push rod	101	60010-00	⊕ Binding tap-tight screw M3 × 5 ⊕
61	43048-00	Return spring	102	60009-07	⊕ Pan head screw M4 × 5
62	43049-05	Power switch cushion	103	60007-08	⊕ Pan head screw M4 × 5
63	44089-17	Push button (A)	104	60032-06	⊕ Binding screw M3 × 5 ⊕
64	44090-10	Push button (B)	105	60010-00	⊕ Pan head tap-tight screw M3 × 5
65	44133-09	Cushion washer	106	60011-04	⊕ Pan head screw M2.6 × 8 ⊕
66	60001-00	Spacer φ3 × 141	107	60034-05	⊕ Flat head screw M3 × 30
67	00029-09	Micro switch AM4700	108	90001-03	Six sided wrench M5
68	60012-09	E-ring φ4 × 0.6t	109	41554-06	Record adaptor 45 rpm
69	60006-03	⊕ Pan head screw M3 × 6	110	44454-09	Carton box
70	60033-00	⊕ Pan head screw M3 × 12	111	30800-10	Top packing
71	60008-02	⊕ Pan head screw M3 × 40	112	20548-07	Middle packing
72	60013-03	Spring washer M3	113	30799-06	Bottom packing
73	30776-26	Case	114		Turntable ass'y
74	44079-13	Cushion felt	115		Control unit ass'y
75	44066-21	Circuit board mounting spacer stud	116	70006-04	Polystyrene sheet
76	44067-26	Display acryl	117	44161-00	Arm rest base
77		LED Circuit board ass'y	118	44217-18	Rest base collar 61
78	44364-00	LED Circuit board	119	44218-12	Rest base collar 81
79	00031-06	LED TLR-102	120	60003-00	Hexagonal hall head bolt M5 × 8 ⊕
80	43042-03	Collar	121	60004-04	Washer M5
81	44129-39	Connector mounting	122	60005-09	Spring washer M5
82	00032-00	Variable resistor 10kΩ (B)			
83	44094-02	Speed adjustment			
84	30763-29	Power transformer			
85	44075-15	Power switch mechanism ass'y			
86	43856-33	Switch lever			
87	44084-20	Switch mounting plate			
88	43971-04	Push switch			
89	44044-04	Power switch button			
90	44088-07	Push button (Power)			
91	00053-02	Micro switch AM-4100			
92	00047-07	Connector MC8M			

SCHEMATIC DIAGRAM

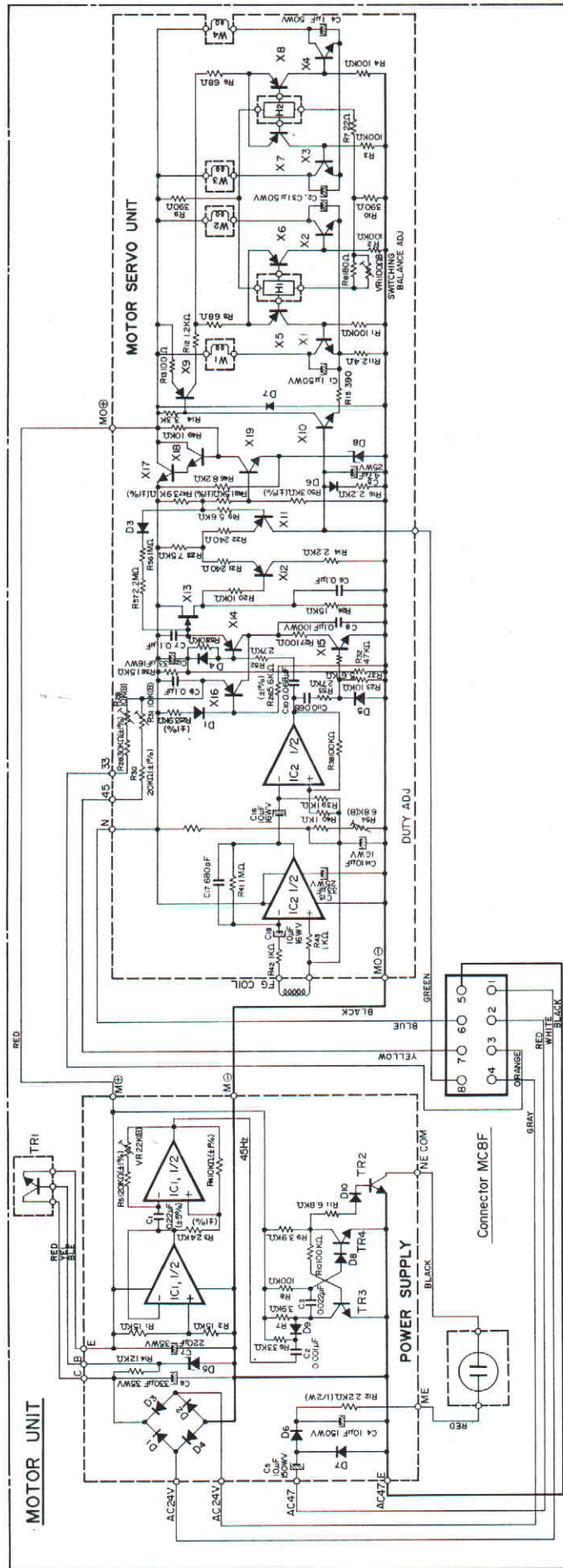

DIAGRAM

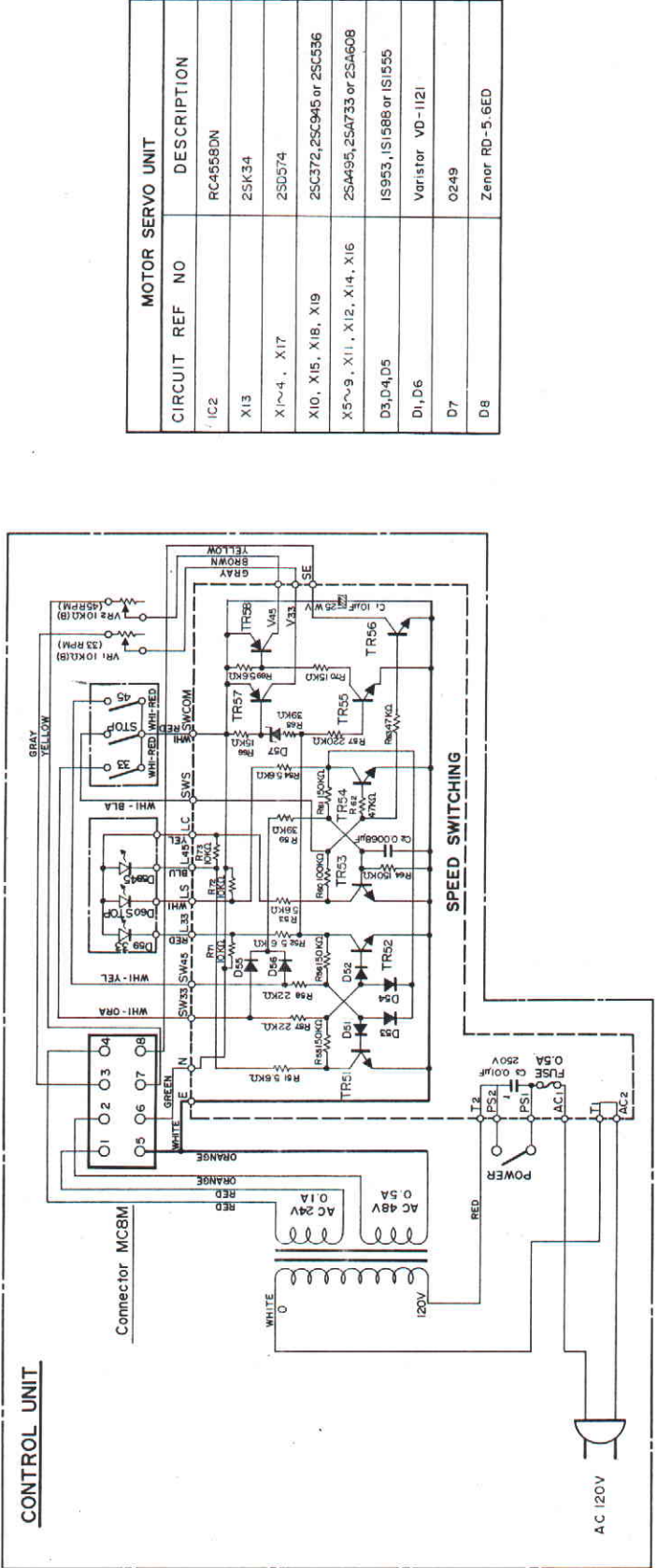

CIRCUIT REF NO	DESCRIPTION
IC2	RC4558DN
X13	25K34
X1~4, X17	25D574
X10, X15, X18, X19	25C372, 25C945 or 25C536
X5~9, X11, X12, X14, X16	25A495, 25A733 or 25A608
D3, D4, D5	IS953, IS1588 or IS1555
D1, D6	Varistor VD-1121
D7	0249
D8	Zenor RD-5.6ED

PACKING FOR SHIPMENT

