

Boost Controller for WLED Driver in Medium-sized LCD Panel AP3041

General Description

The AP3041 is a current mode high voltage low-side channel MOSFET controller, which is ideal for boost regulators. It contains all the features needed to implement single-ended primary topology DC/DC converters.

The input voltage of AP3041 ranges from 5V to 27V. Its operation frequency is adjustable from 100kHz to 1MHz.

The AP3041 has UVLO (Under Voltage Lock Out) circuit. It uses two external resistors to set the UVLO voltage. The AP3041 also has an over output voltage protection to limit the output voltage. The OVP voltage can be set through external resistors. If the output voltage is higher than the OVP high threshold point, it will disable the driver and the system is latched up. The output short circuit protection as well as LED low side short to ground detection function can be applied in system.

The AP3041 has other protection functions, such as LED short protection, LED high side short to ground protection, diode short protection, over current protection, over temperature protection and so on.

The AP3041 is available in SOIC-16 package.

Features

- Input Voltage Range: 5V to 27V
- 1A Peak and 10V MOSFET Gate Driver
- 20ns Quick MOSFET Gate Driver
- Duty Cycle Limit of 90%
- Programmable UVLO
- PWM Dimming Control
- Programmable Over Voltage Protection
- LED Open Protection
- LED Short Circuit Protection
- Diode Short Circuit Protection
- Output Short Circuit Protection
- LED Low-side Short to Ground Detection
- OV Pin Under Voltage Protection
- Over Current Protection
- Programmable Slope Compensation
- Adjustable Soft-start
- Adjustable Protection Delay
- Fault Status Indication
- Adjustable Operation Frequency from 100kHz to 1MHz
- Over Temperature Protection

Applications

- LED Lighting
- LED TV
- LCD Display Modules

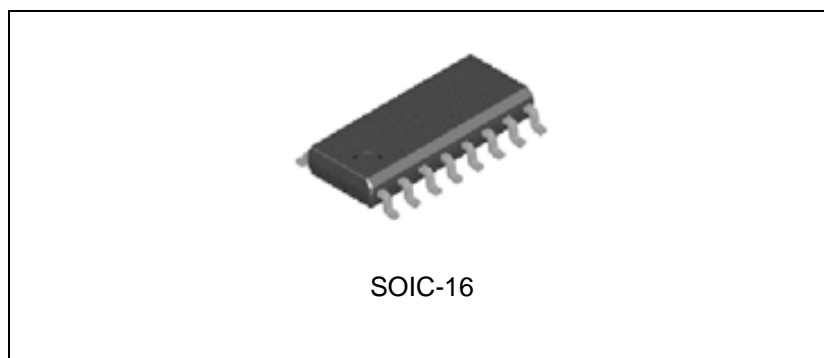

Figure 1. Package Type of AP3041

Boost Controller for WLED Driver in Medium-sized LCD Panel AP3041**Pin Configuration**

Figure 2. Pin Configuration of AP3041 (Top View)

**Boost Controller for WLED Driver in Medium-sized LCD Panel AP3041****Pin Description**

Pin Number	Pin Name	Function
1	CT	Capacitor setting shut down delay time
2	OV	Over output voltage protection pin
3	UVLO	Two resistors connected from this pin to GND and the power supply respectively are used to set start-up and shutdown level
4	EN	Enable pin
5	VIN	Input supply pin. This pin must be locally bypassed
6	VCC	This pin should be bypassed to GND with a ceramic capacitor
7	OUT	Connect this pin to the gate of external MOSFET, the gate driver has 1A peak current capability
8	GND	Ground
9	FAULT	This pin can be used to drive the external MOSFET. The logic of the driver signal is controlled by that of PWM pin and the signal phase of them is the same. This pin is pulled to ground under fault condition of OVP, UVLO, OTP, diode short circuit and LED short circuit.
10	RT	An external resistor connected from this pin to GND is used to set the operating frequency
11	CS	Sense switch current pin, which is used for current mode control and for current limit. The current limit voltage is 500mV
12	SC	Slope compensation for current sense. A resistor between SC and GND will program the slope compensation
13	SS/COMP	An external soft-start time capacitor is placed from this pin to GND and is charged by an internal 20 μ A current source to control regulator soft-start time. Compensation pin. This pin is the output of the internal error amplifier.
14	FB	Voltage feedback pin. The reference voltage is 500mV
15	PWM	This pin can be connected to current matched chip and receives error signal used to shut down the system
16	FLAG	Fault condition output pin. When the output is in short circuit condition, the FLAG outputs logic low to shut down the power path. Please refer to the application circuit

Boost Controller for WLED Driver in Medium-sized LCD Panel AP3041

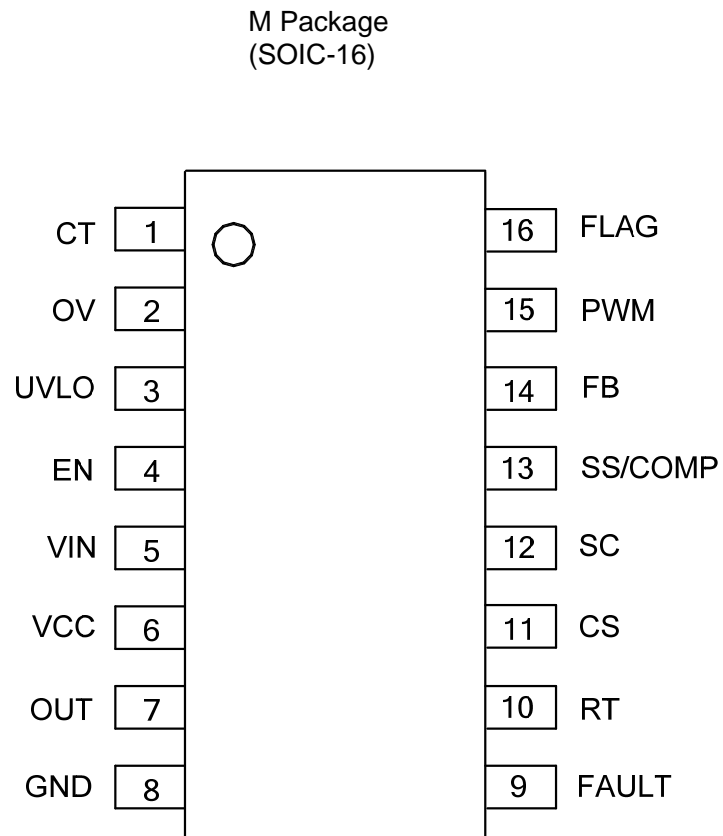
Functional Block Diagram

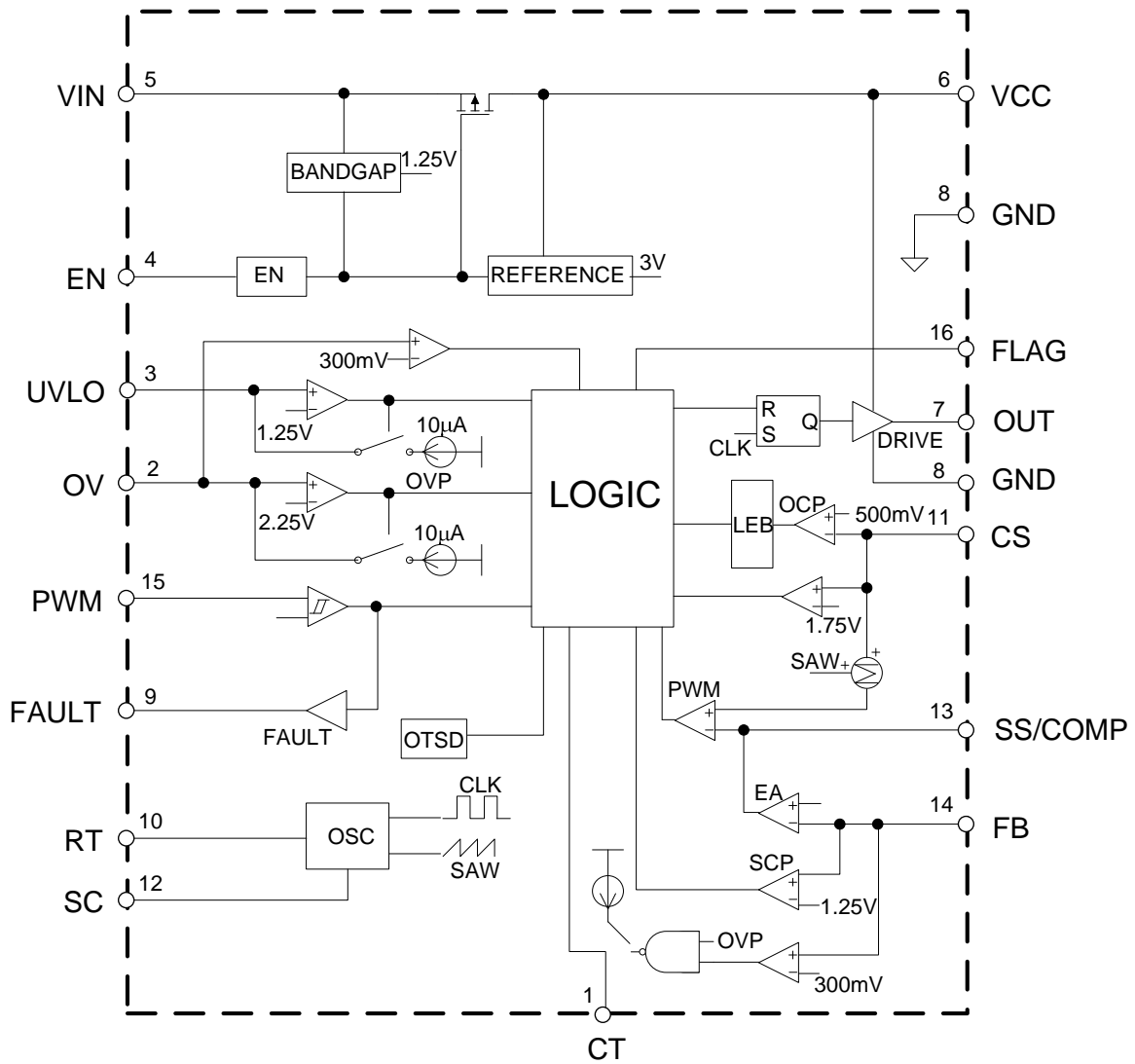
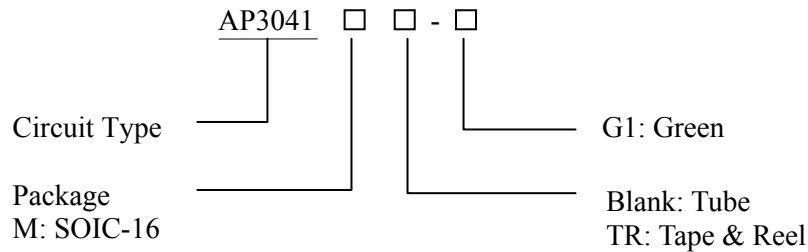

Figure 3. Functional Block Diagram of AP3041

Boost Controller for WLED Driver in Medium-sized LCD Panel AP3041
Ordering Information

Package	Temperature Range	Part Number	Marking ID	Packing Type
SOIC-16	-40 to 85°C	AP3041M-G1	AP3041M-G1	Tube
		AP3041MTR-G1	AP3041M-G1	Tape & Reel

BCD Semiconductor's Pb-free products, as designated with "G1" suffix in the part number, are RoHS compliant and green.

Absolute Maximum Ratings (Note 1)

Parameter	Symbol	Value	Unit
Input Voltage	V_{IN}	30	V
VCC Pin Voltage	V_{CC}	20	V
OUT Pin Voltage	V_{OUT}	20	V
FAULT Pin Voltage	V_{FAULT}	20	V
FB Pin Voltage	V_{FB}	20	V
UVLO Pin Voltage	V_{UVLO}	7	V
CS Pin Voltage	V_{CS}	20	V
SC Pin Voltage	V_{SC}	7	V
FLAG Pin Voltage	V_{FLAG}	7	V
SS/COMP Pin Voltage	$V_{SS/COMP}$	7	V
RT Pin Voltage	V_{RT}	7	V
PWM Pin Voltage	V_{PWM}	7	V
EN Pin Voltage	V_{EN}	30	V
OV Pin Voltage	V_{OV}	7	V
Thermal Resistance (Junction to Ambient, No Heat Sink, Free Air)	θ_{JA}	82	°C/W

**Boost Controller for WLED Driver in Medium-sized LCD Panel AP3041****Absolute Maximum Ratings (Note 1, Continued)**

Parameter	Symbol	Value	Unit
Operating Junction Temperature	T_J	150	°C
Storage Temperature	T_{STG}	-65 to 150	°C
Lead Temperature (Soldering, 10 sec)	T_{LEAD}	260	°C
ESD (Human Body Model)		2000	V
ESD (Machine Model)		200	V

Note 1: Stresses greater than those listed under “Absolute Maximum Ratings” may cause permanent damage to the device. These are stress ratings only, and functional operation of the device at these or any other conditions beyond those indicated under “Recommended Operating Conditions” is not implied. Exposure to “Absolute Maximum Ratings” for extended periods may affect device reliability.

Recommended Operating Conditions

Parameter	Symbol	Min	Max	Unit
Input Voltage	V_{IN}	5	27	V
Operating Frequency	f	0.1	1	MHz
Operating Temperature Range	T_J	-40	85	°C

Electrical Characteristics

$V_{CC}=12V$, $V_{EN}=3.3V$, $T_A=25^\circ C$, unless otherwise specified.

Parameter	Symbol	Conditions	Min	Typ	Max	Unit
Input Voltage	V_{IN}		5		27	V
Feedback Voltage	V_{FB}		490	500	510	mV
Supply Current	I_{CC}	$V_{FB}=V_{IN}$, no switching		1.5	5	mA
Shutdown Supply Current	I_Q	$V_{EN}=0$		1	2	μA
VCC Voltage	V_{CC}	$11V \leq V_{IN} \leq 27V$	9.5	10.0	10.5	V
		$5V \leq V_{IN} \leq 10V$, $I_{CC}=5mA$	$V_{IN}-0.5$			V
VCC Current Limit	I_{CC-LIM}			35		mA
VCC Pin UVLO Rising Threshold	V_{CC-HI}			4.7		V
VCC Pin UVLO Falling Hysteresis	V_{CC-HYS}			300		mV
Oscillator Frequency	f_{OSC}		0.1		1	MHz
SC Peak Voltage	V_{SC_PK}		530		680	mV
UVLO Threshold	V_{UVLO}		1.20	1.25	1.30	V
UVLO Hysteresis Current Source	$I_{UVLO-HYS}$			10		μA

**Boost Controller for WLED Driver in Medium-sized LCD Panel AP3041****Electrical Characteristics (Continued)**

$V_{CC}=12V$, $V_{EN}=3.3V$, $T_A=25^{\circ}C$, unless otherwise specified.

Parameter	Symbol	Conditions	Min	Typ	Max	Unit
Current Limit Threshold Voltage	V_{CS}		0.48	0.5	0.52	V
RT Voltage	V_{RT}		1.20	1.25	1.30	V
Error Amplifier Voltage Gain	G_V			680		V/V
Error Amplifier Transconductance	G_S			500		$\mu A/V$
EN Pin Threshold Voltage	V_{EH}		2.5			V
	V_{EL}				0.5	
PWM Pin Threshold Voltage	V_{IH}		2.5			V
	V_{IL}				0.5	
OV Threshold	V_{OV}			2.25		V
OV Hysteresis Current Source	I_{OV-HYS}			10		μA
LED- Short to GND Detection Level	V_{FB_LOW}			0.3		V
LED+ Short to LED-Detection Level	V_{FB_HIGH}			1.25		V
LED+ Short to GND Detection Level	V_{OV_LOW}			0.3		V
Diode Short Detection Level	V_{CS_HIGH}			1.75		V
CT Current Source	I_{CT}			5		μA
CT Threshold Voltage	V_{CT}			2.6		V
Maximum Duty Cycle	D_{MAX}	$f=200kHz$	80	90		%
Soft-start Current Source	I_{SS}		16	22	28	μA
OUT Pin Rising Time	t_{RISE}	$C_{OUT}=1nF$		20		ns
OUT Pin Falling Time	t_{FALL}	$C_{OUT}=1nF$		20		
OUT High Voltage Level ($V_{CC}-V_{OUT}$)	V_{OUT-H}	$I_{OUT}=50mA$		0.25	0.75	V
OUT Low Voltage Level (V_{OUT})	V_{OUT-L}	$I_{OUT}=50mA$		0.25	0.75	V
FAULT Pin Rising Time	t_{RISE}	$C_{FAULT}=1nF$		100		ns
FAULT Pin Falling Time	t_{FALL}	$C_{FAULT}=1nF$		100		
FAULT High Voltage Level ($V_{CC}-V_{FAULT}$)	V_{FAULT_H}	$I_{FAULT}=10mA$		0.25	0.75	V
FAULT Low Voltage Level	V_{FAULT_L}	$I_{FAULT}=10mA$		0.25	0.75	V
FAULT Minimum Pulse Width	t_D	Oscillator Frequency=200kHz		20		μs
FLAG High Voltage Level	V_{FLAG-H}	$I_{FLAG}=500\mu A$		2		V
FLAG Low Voltage Level	V_{FLAG-L}	$I_{FLAG}=500\mu A$		0.25	0.75	V
Thermal Shutdown Temperature	T_{OTSD}			160		$^{\circ}C$
Thermal Shutdown Hysteresis	T_{HYS}			20		$^{\circ}C$

Boost Controller for WLED Driver in Medium-sized LCD Panel AP3041

Typical Performance Characteristics

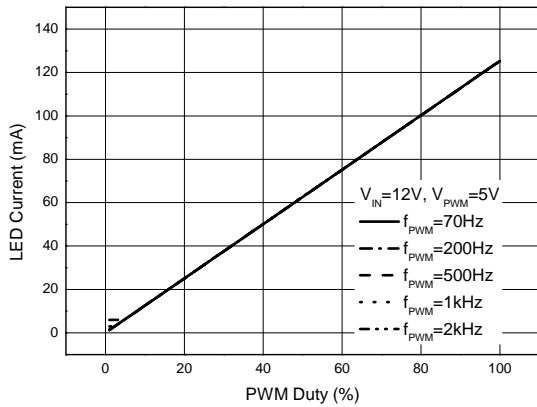

Figure 4. LED Current vs. PWM Duty

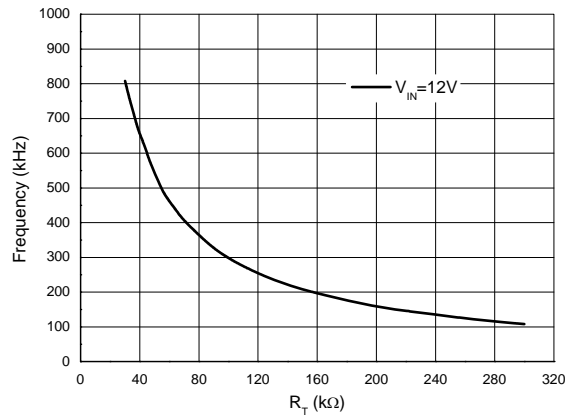

Figure 5. Frequency vs. R_T

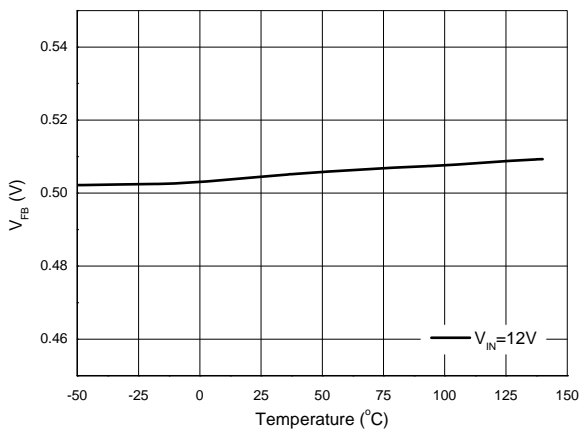

Figure 6. V_{FB} vs. Temperature

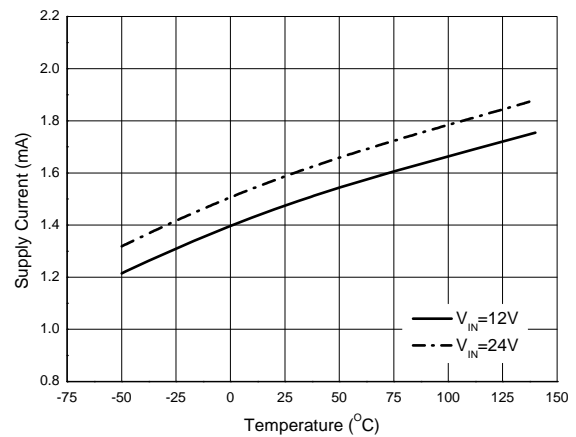

Figure 7. Supply Current vs. Temperature

Boost Controller for WLED Driver in Medium-sized LCD Panel AP3041

Typical Performance Characteristics (Continued)

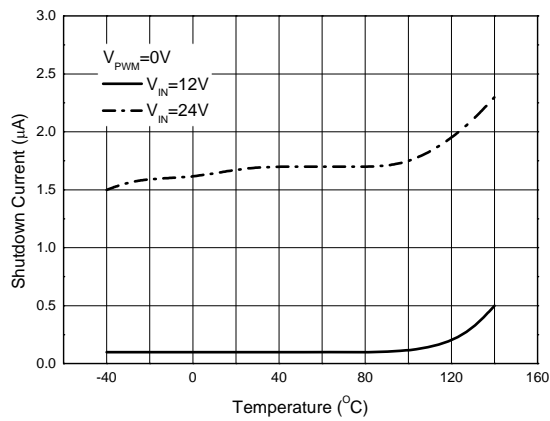

Figure 8. Supply Current vs. Temperature

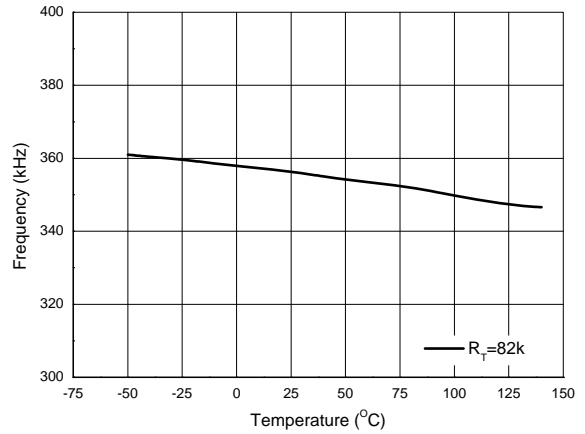

Figure 9. Frequency vs. Temperature

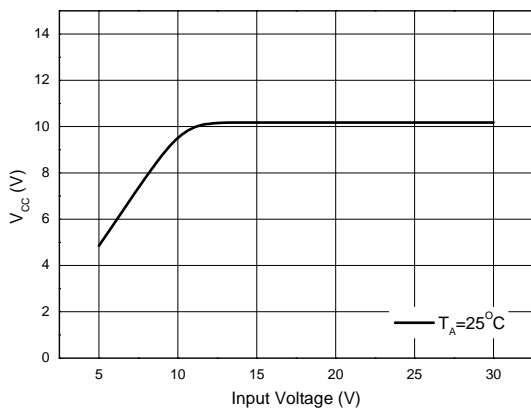

Figure 10. V_{CC} vs. Input Voltage

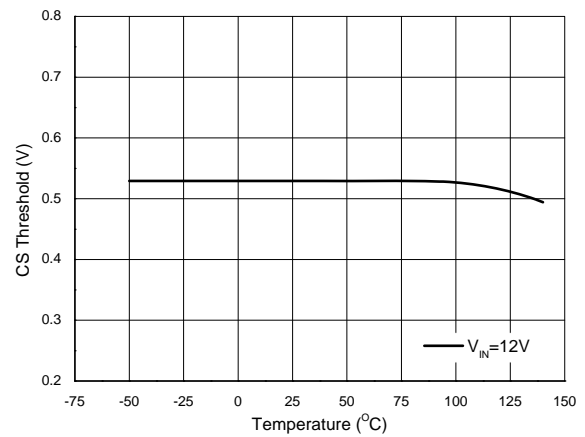

Figure 11. CS Threshold vs. Temperature

Boost Controller for WLED Driver in Medium-sized LCD Panel AP3041

Typical Performance Characteristics (Continued)

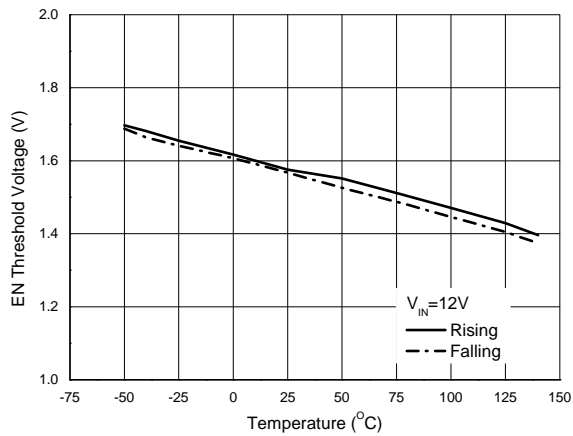

Figure 12. EN Threshold Voltage vs. Temperature

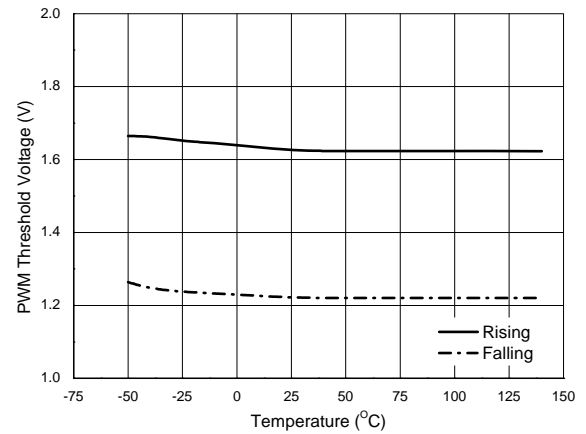

Figure 13. PWM Threshold Voltage vs. Temperature

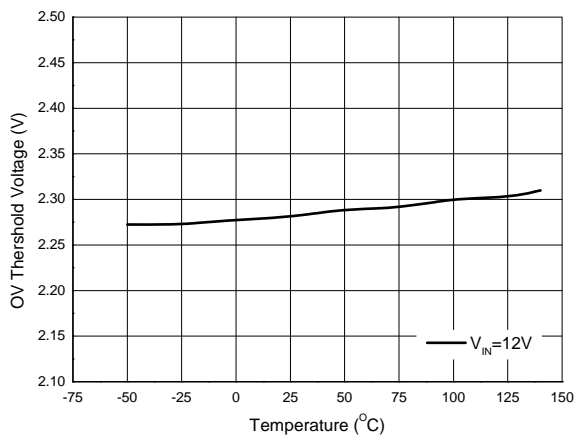

Figure 14. OV Threshold Voltage vs. Temperature

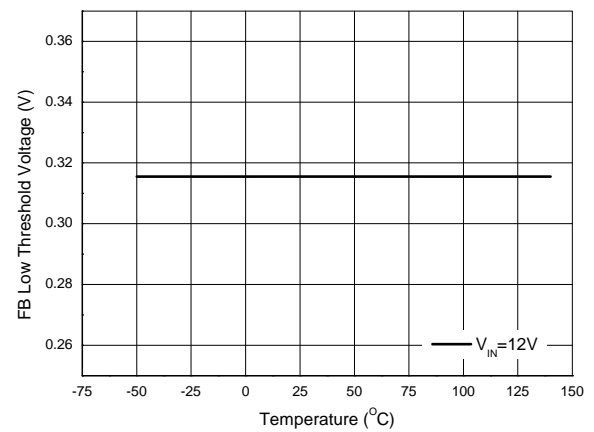

Figure 15. FB Low Threshold Voltage vs. Temperature

Boost Controller for WLED Driver in Medium-sized LCD Panel AP3041

Typical Performance Characteristics (Continued)

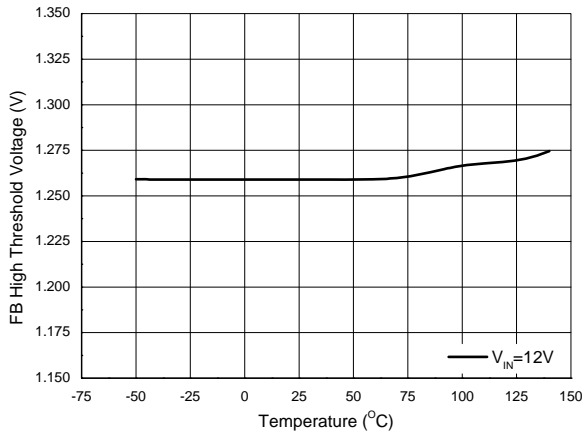

Figure 16. FB High Threshold Voltage vs. Temperature

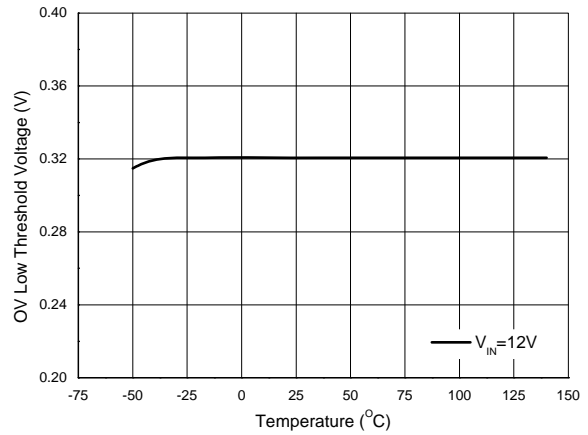

Figure 17. OV Low Threshold Voltage vs. Temperature

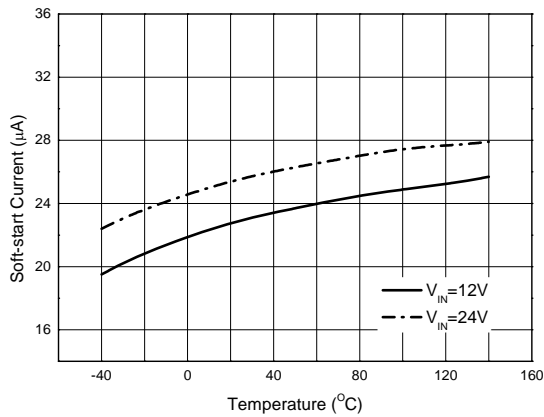

Figure 18. Soft-start Current vs. Temperature

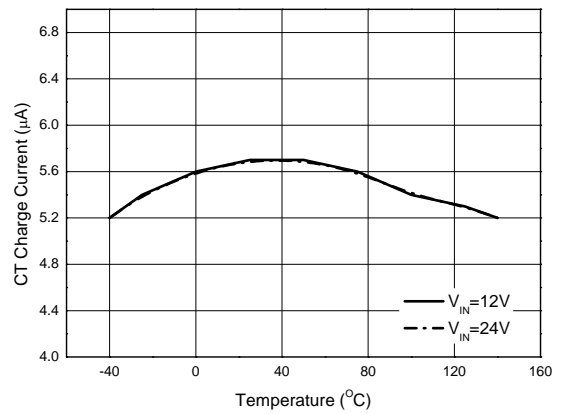

Figure 19. CT Charge Current vs. Temperature

Boost Controller for WLED Driver in Medium-sized LCD Panel AP3041

Typical Application

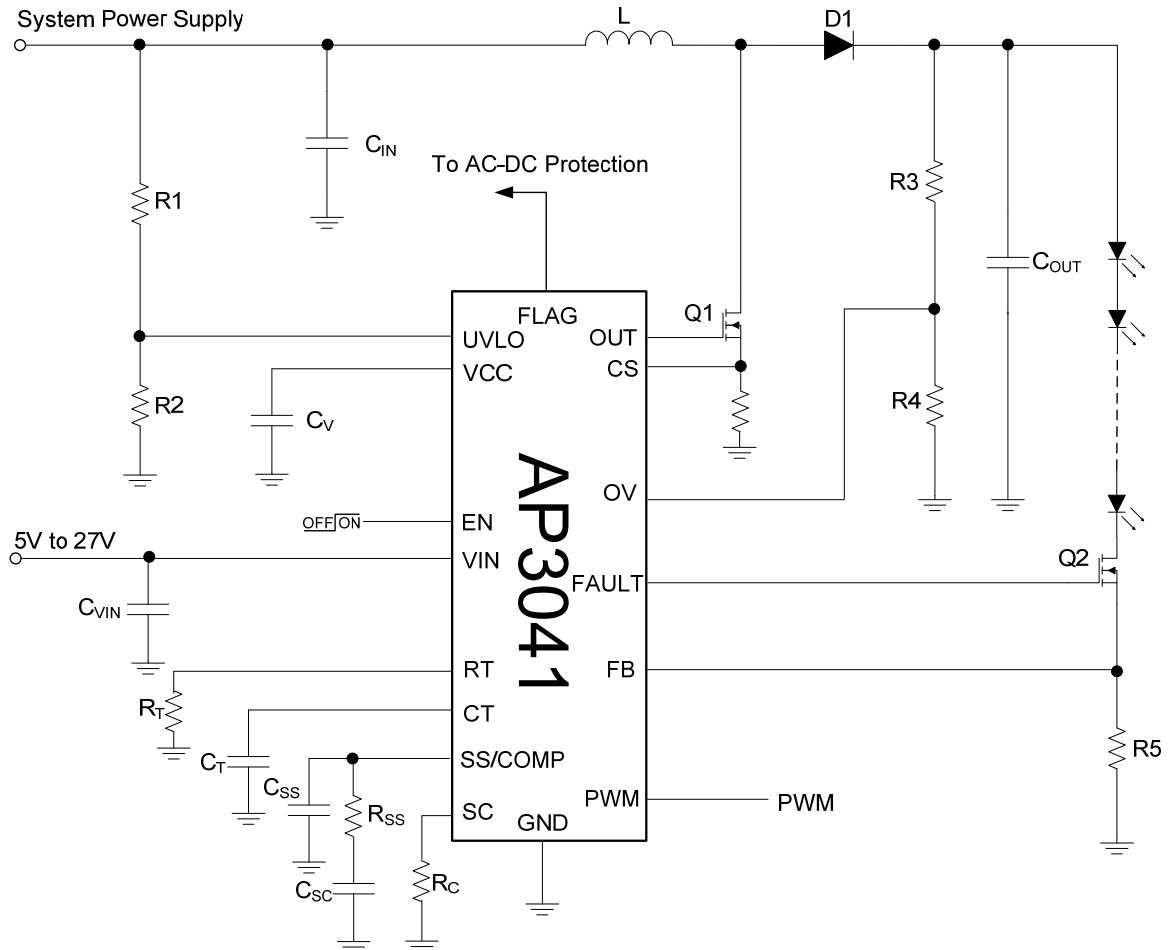

Figure 20. Typical Application Circuit of AP3041



BCD Semiconductor Manufacturing Limited

<http://www.bcdsemi.com>

IMPORTANT NOTICE

BCD Semiconductor Manufacturing Limited reserves the right to make changes without further notice to any products or specifications herein. BCD Semiconductor Manufacturing Limited does not assume any responsibility for use of any its products for any particular purpose, nor does BCD Semiconductor Manufacturing Limited assume any liability arising out of the application or use of any its products or circuits. BCD Semiconductor Manufacturing Limited does not convey any license under its patent rights or other rights nor the rights of others.

MAIN SITE

- Headquarters

BCD Semiconductor Manufacturing Limited

No. 1600, Zi Xing Road, Shanghai Zizhu Science-based Industrial Park, 200241, China
Tel: +86-21-24162266, Fax: +86-21-24162277

- Wafer Fab

Shanghai SIM-BCD Semiconductor Manufacturing Co., Ltd.

800 Yi Shan Road, Shanghai 200233, China
Tel: +86-21-6485 1491, Fax: +86-21-5450 0008

REGIONAL SALES OFFICE

Shenzhen Office

Shanghai SIM-BCD Semiconductor Manufacturing Co., Ltd., Shenzhen Office

Unit A Room 1203, Skyworth Bldg., Gaoxin Ave. 1.S., Nanshan District, Shenzhen, China
Tel: +86-755-8826 7951
Fax: +86-755-8826 7865

Taiwan Office

BCD Semiconductor (Taiwan) Company Limited

4F, 298-1, Rui Guang Road, Nei-Hu District, Taipei, Taiwan
Tel: +886-2-2656 2808
Fax: +886-2-2656 2806

USA Office

BCD Semiconductor Corp.

30920 Huntwood Ave. Hayward, CA 94544, USA
Tel : +1-510-324-2988
Fax: +1-510-324-2788