

**2SC4664**  
**(TP8V20FS)**

**8A NPN**

### OUTLINE DIMENSIONS

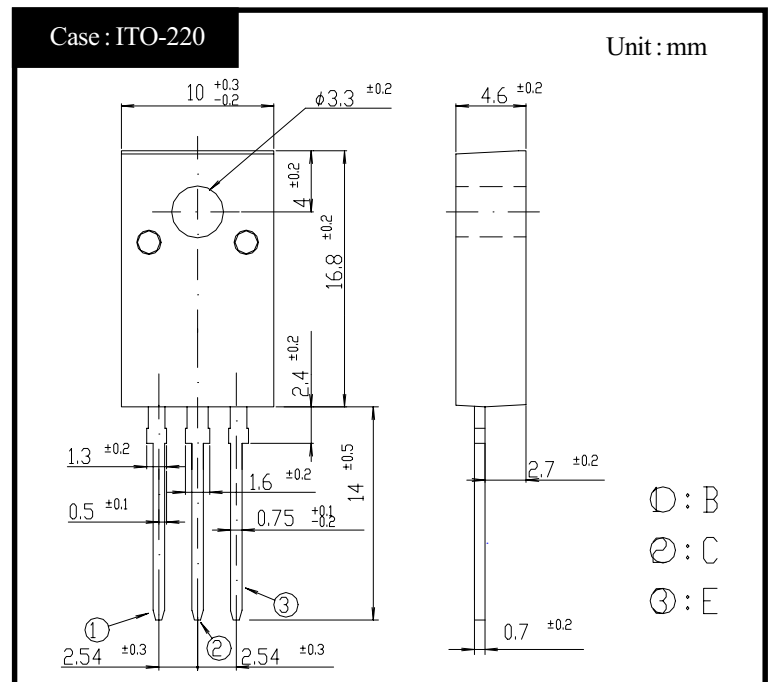

### RATINGS

#### ● Absolute Maximum Ratings

Item	Symbol	Conditions	Ratings	Unit
Storage Temperature	$T_{stg}$		-55~150	°C
Junction Temperature	$T_j$		150	°C
Collector to Base Voltage	$V_{CBO}$		250	V
Collector to Emitter Voltage	$V_{CEO}$		200	V
Emitter to Base Voltage	$V_{EBO}$		7	V
Collector Current DC	$I_C$		8	A
Collector Current Peak	$I_{CP}$		16	
Base Current DC	$I_B$		3	A
Base Current Peak	$I_{BP}$		6	
Total Transistor Dissipation	$P_T$	$T_c = 25^\circ\text{C}$	30	W
Dielectric Strength	$V_{dis}$	Terminals to case, AC 1 minute	2	kV
Mounting Torque	TOR	(Recommended torque : 0.3N·m)	0.5	N·m

#### ● Electrical Characteristics ( $T_c=25^\circ\text{C}$ )

Item	Symbol	Conditions	Ratings	Unit
Collector to Emitter Sustaining Voltage	$V_{CEO}(\text{sus})$	$I_C = 0.1\text{A}$	Min 200	V
Collector Cutoff Current	$I_{CBO}$	At rated Voltage	Max 0.1	mA
	$I_{CEO}$		Max 0.1	
Emitter Cutoff Current	$I_{EBO}$	At rated Voltage	Max 0.1	mA
DC Current Gain	$h_{FE}$	$V_{CE} = 2\text{V}, I_C = 4\text{A}$	10~25 <sup>*1</sup>	
	$h_{FEL}$	$V_{CE} = 2\text{V}, I_C = 1\text{mA}$	Min 10	
Collector to Emitter Saturation Voltage	$V_{CE}(\text{sat})$	$I_C = 4\text{A}$	Max 1.0	V
Base to Emitter Saturation Voltage	$V_{BE}(\text{sat})$	$I_B = 0.8\text{A}$	Max 1.5	V
Thermal Resistance	$\theta_{jc}$	Junction to case	Max 4.17	°C/W
Transition Frequency	$f_T$	$V_{CE} = 10\text{V}, I_C = 0.8\text{A}$	TYP 13	MHz
Turn on Time	$t_{on}$	$I_C = 4\text{A}$ $I_{B1} = 0.8\text{A}, I_{B2} = 1.6\text{A}$ $R_L = 37.5\Omega, V_{BB2} = 4\text{V}$	Max 0.3	$\mu\text{s}$
Storage Time	$t_s$		Max 1.0	
Fall Time	$t_f$		Max 0.1	

2SC4664

$h_{FE} - I_C$

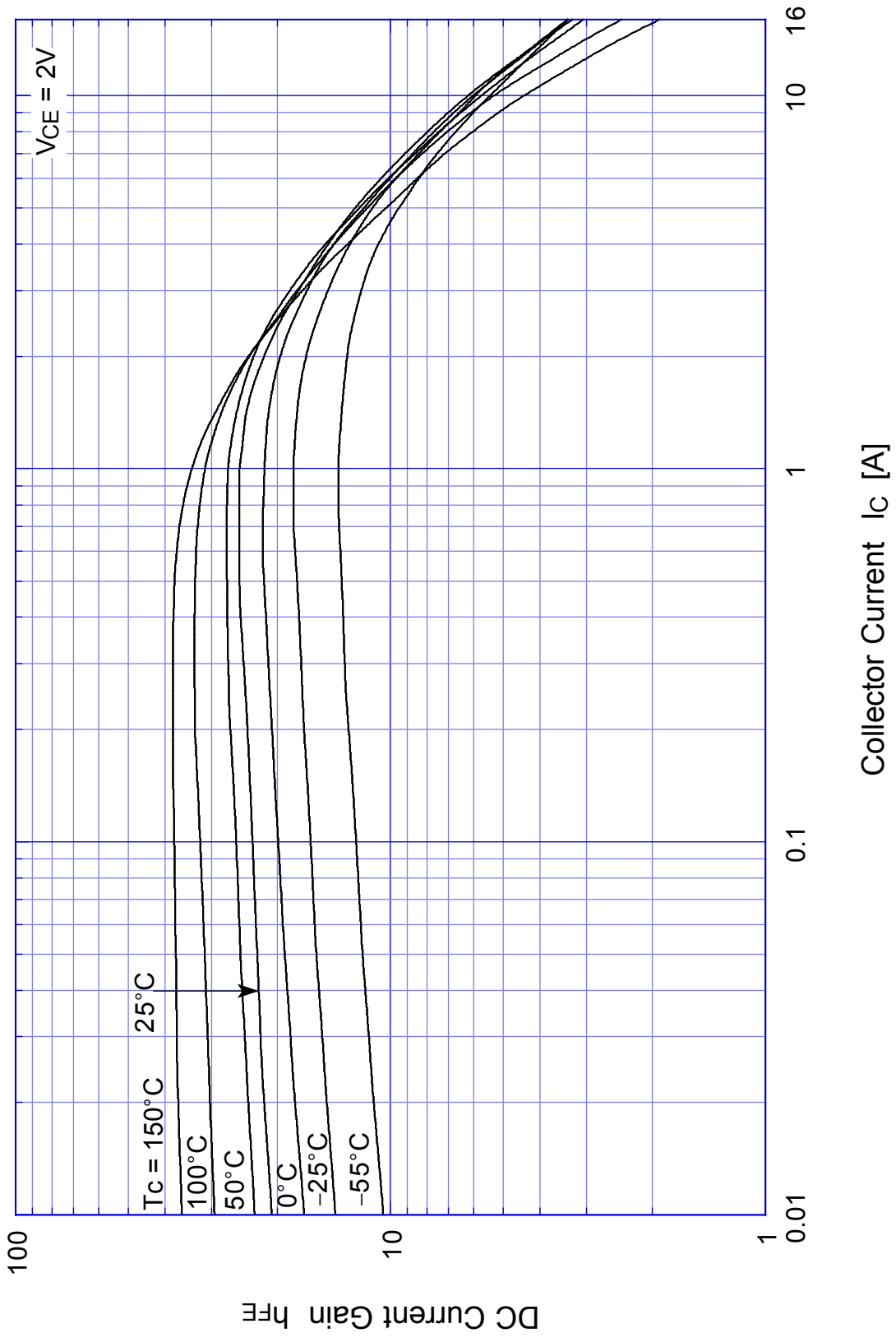

# 2SC4664 Saturation Voltage

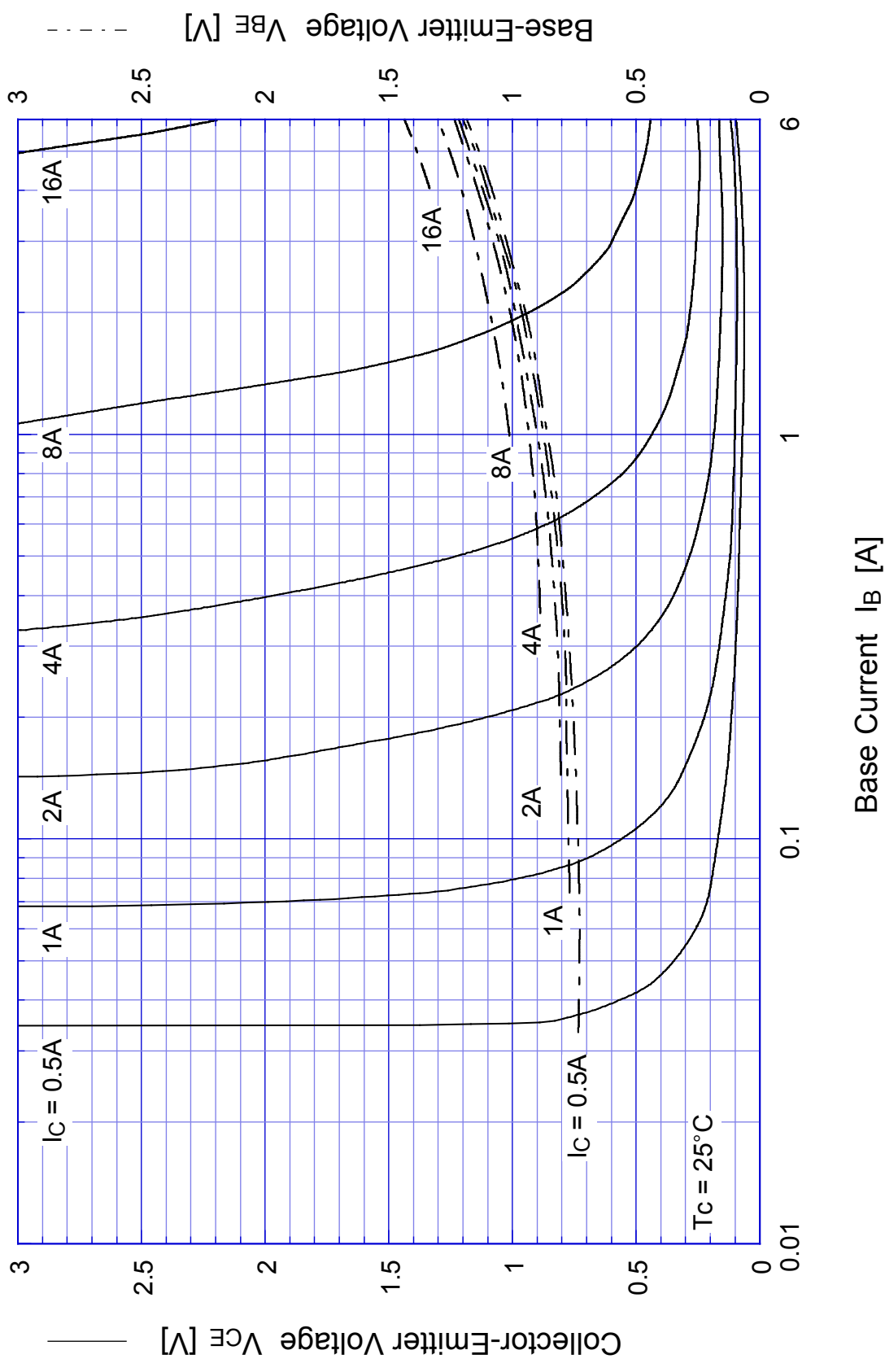

# 2SC4664

## Switching Time - $I_C$

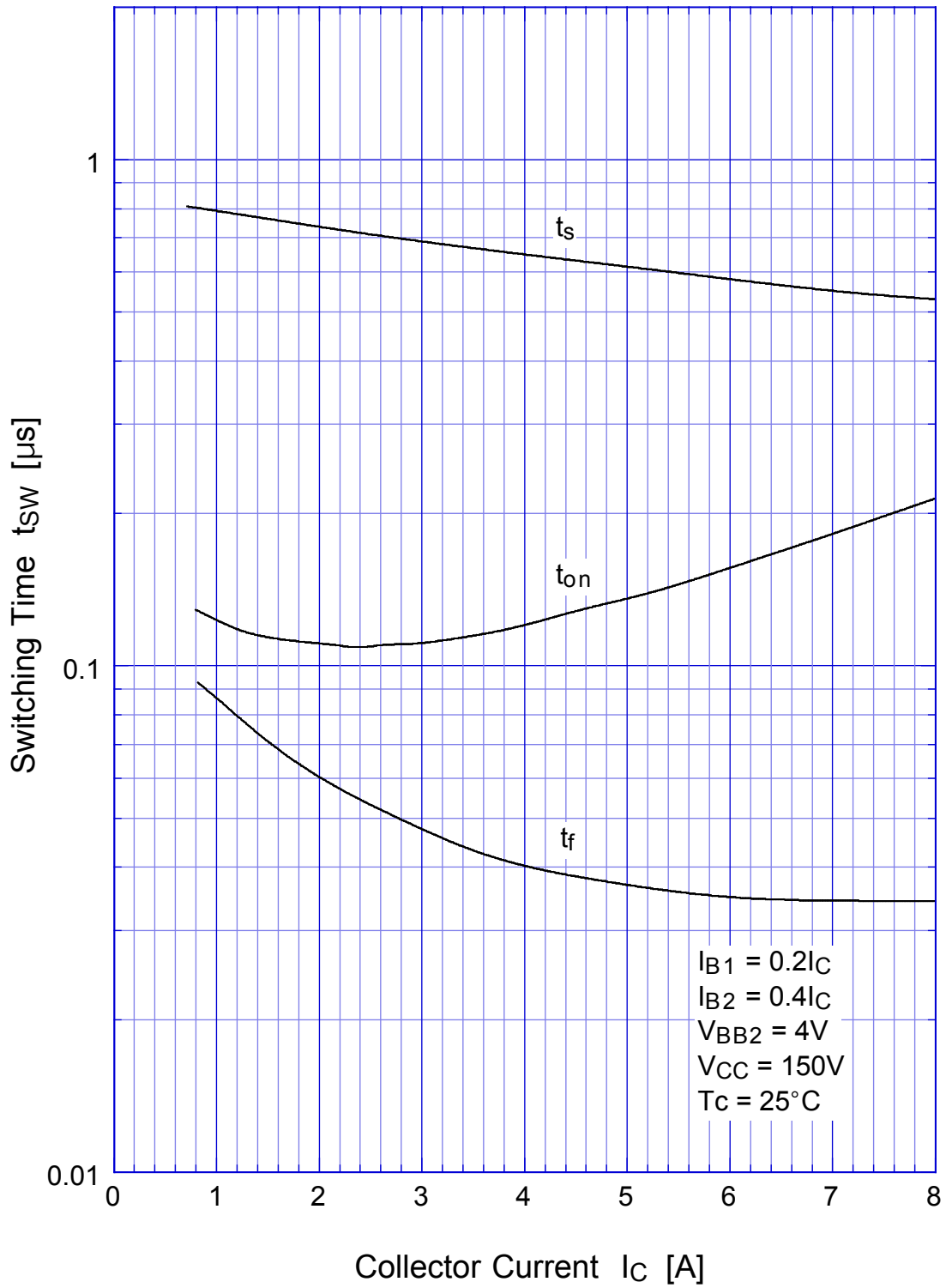

# 2SC4664

## Switching Time - Tc

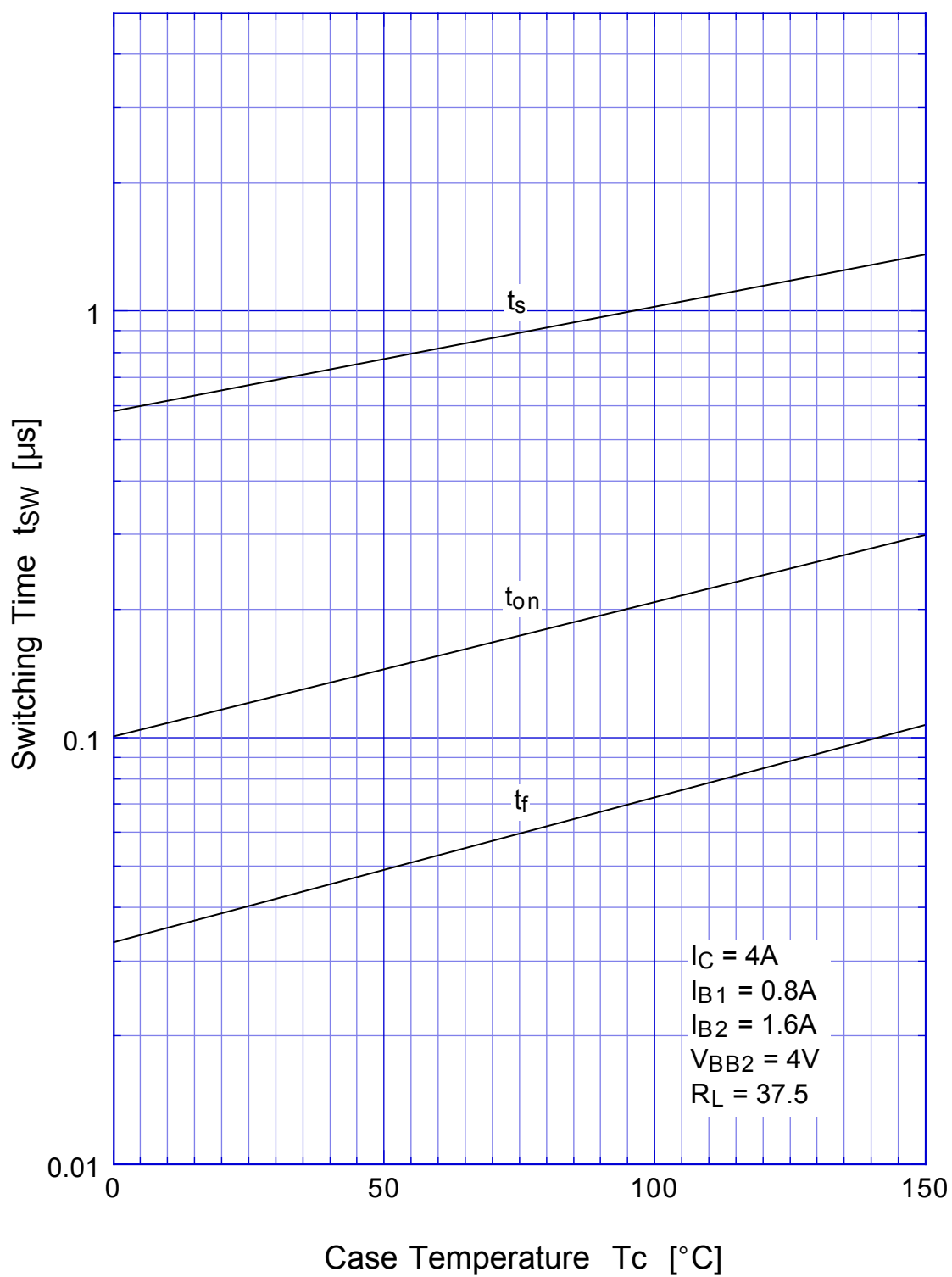

# 2SC4664

## Forward Bias SOA

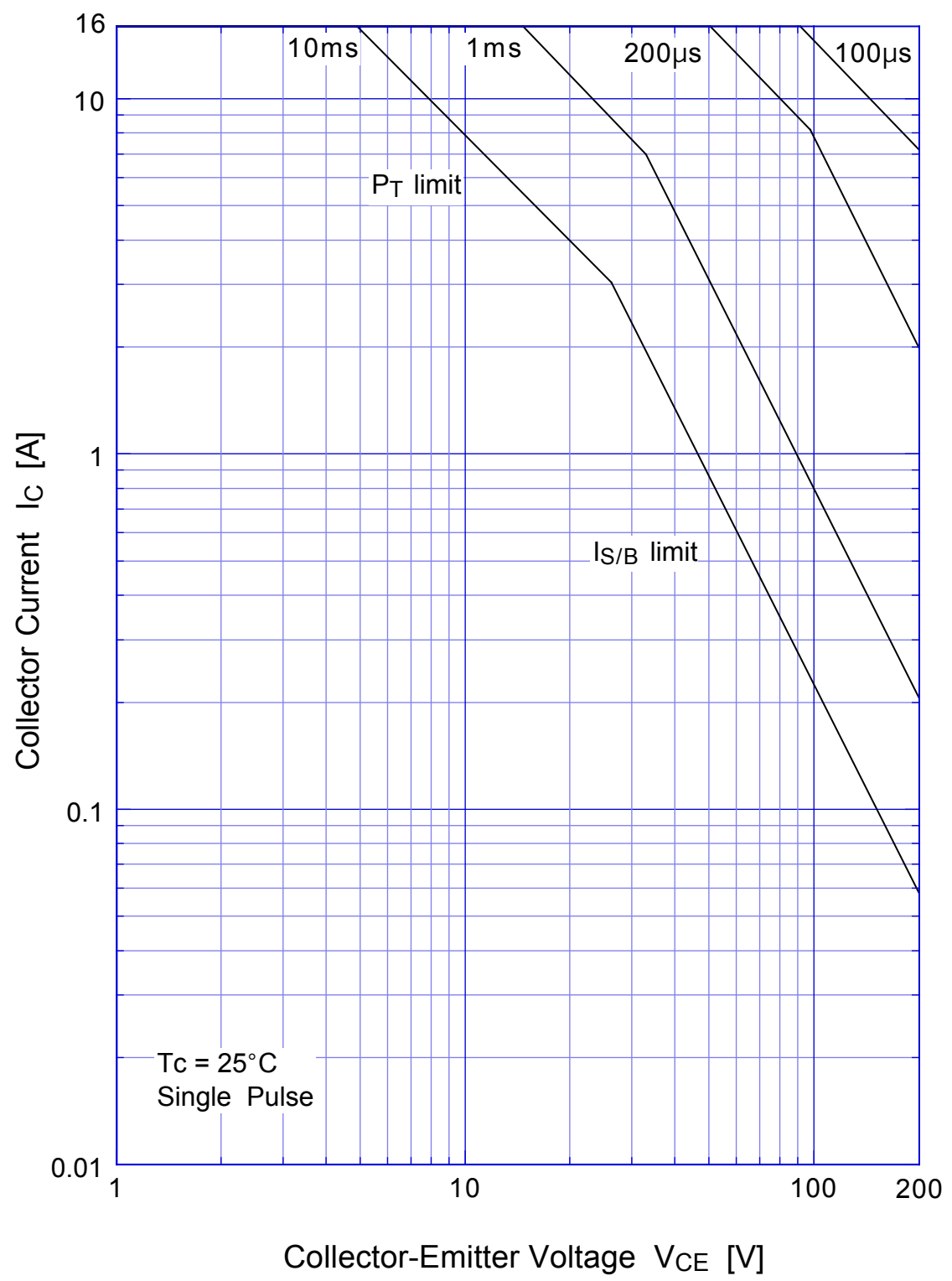

## 2SC4664 Collector Current Derating

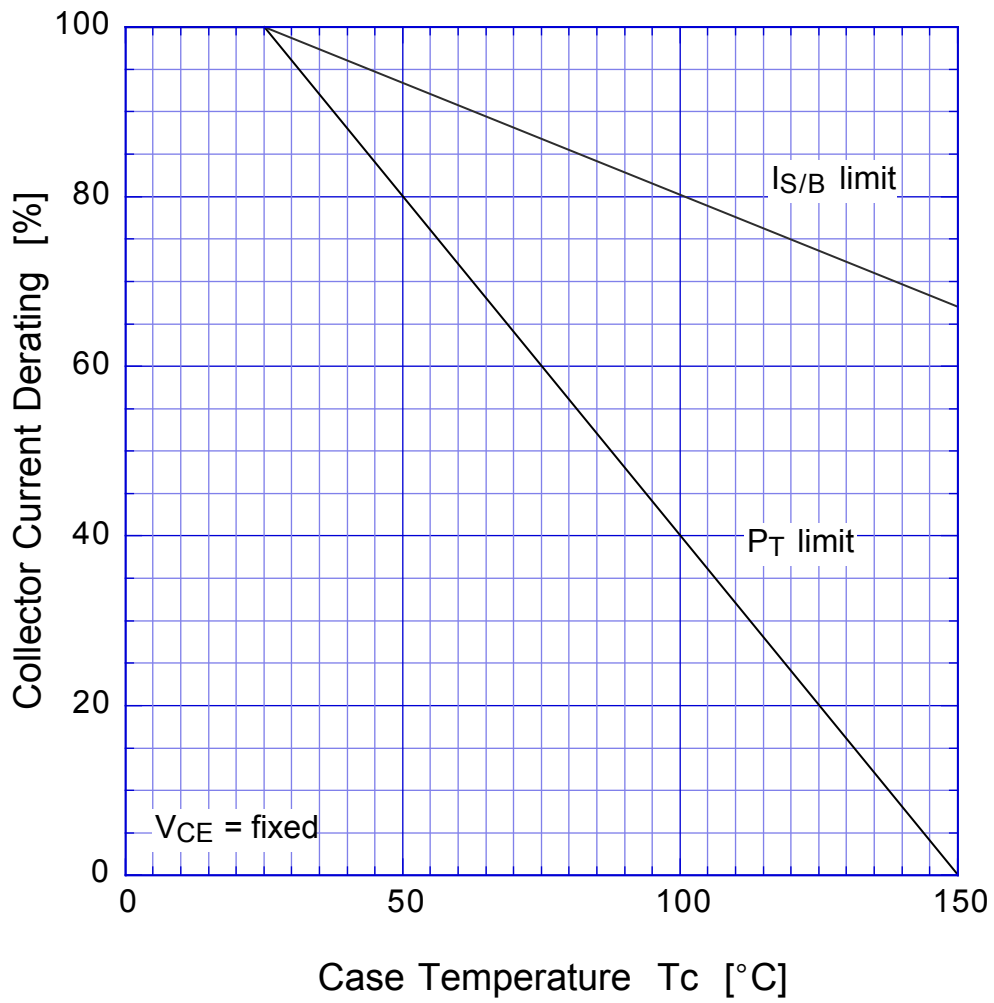

2SC4664

Reverse Bias SOA

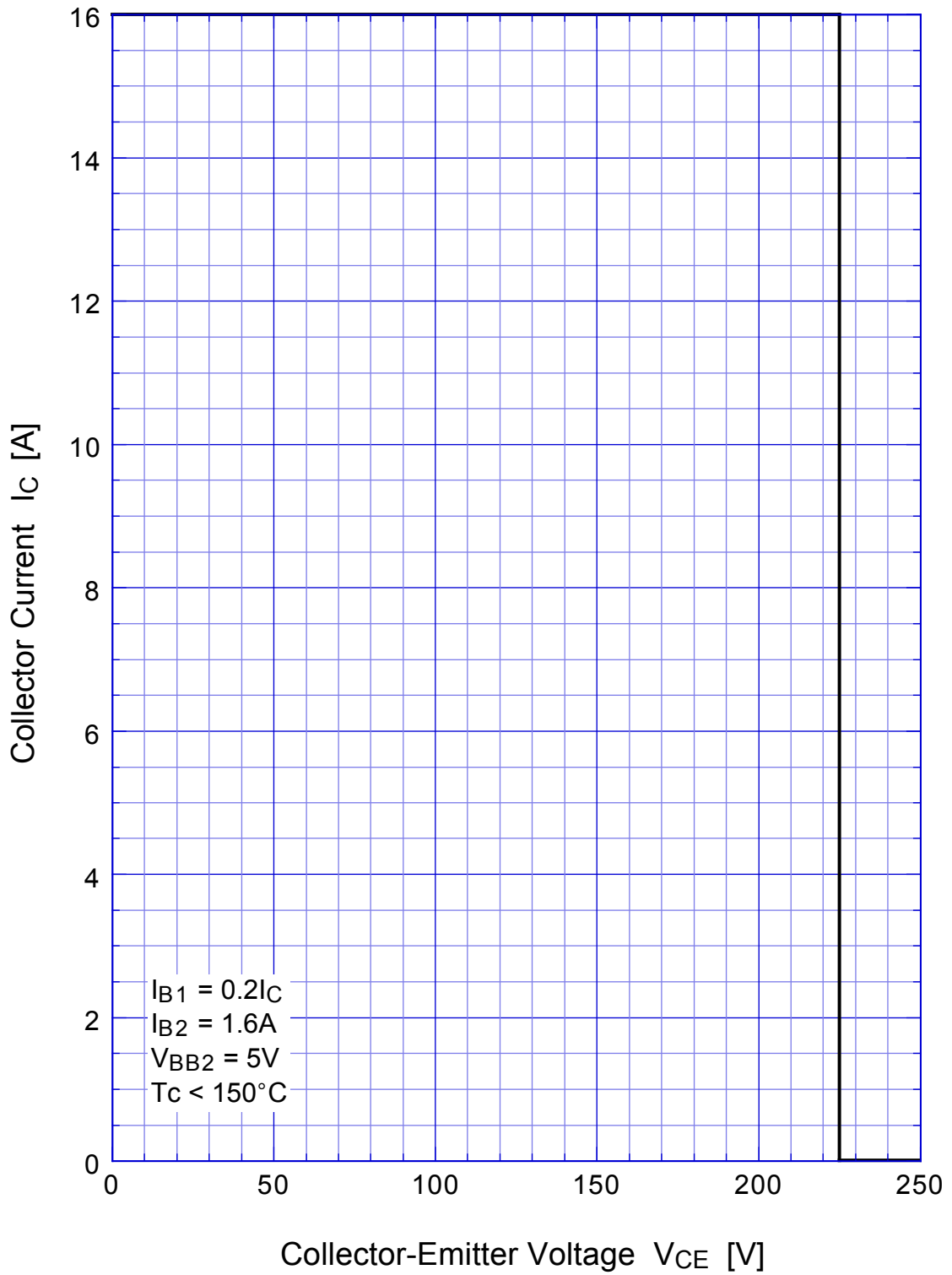



# 2SC4664 Transient Thermal Impedance

