

- ▼ Simple Drive Requirement
- ▼ Good Thermal Performance
- ▼ Fast Switching Performance

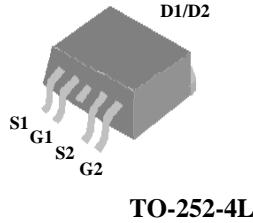

N-CH	BV_{DSS}	40V
	$R_{DS(ON)}$	28mΩ
	I_D	15A
P-CH	BV_{DSS}	-40V
	$R_{DS(ON)}$	42mΩ
	I_D	-12A

Description

Advanced Power MOSFETs from APEC provide the designer with the best combination of fast switching, ruggedized device design, low on-resistance and cost-effectiveness.

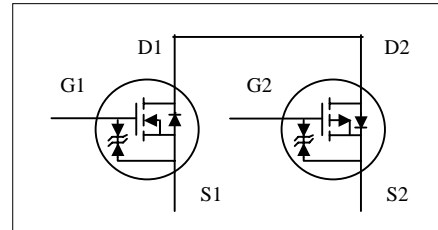

Absolute Maximum Ratings

Symbol	Parameter	Rating		Units
		N-channel	P-channel	
V_{DS}	Drain-Source Voltage	40	-40	V
V_{GS}	Gate-Source Voltage	±16	±16	V
$I_D@T_A=25^\circ C$	Continuous Drain Current	15.0	-12.0	A
$I_D@T_A=70^\circ C$	Continuous Drain Current	12.0	-10.0	A
I_{DM}	Pulsed Drain Current ¹	50	-50	A
$P_D@T_A=25^\circ C$	Total Power Dissipation	10.4		W
	Linear Derating Factor	0.083		W/°C
T_{STG}	Storage Temperature Range	-55 to 150		°C
T_J	Operating Junction Temperature Range	-55 to 150		°C

Thermal Data

Symbol	Parameter	Value	Unit
Rthj-c	Maximum Thermal Resistance, Junction-case	12	°C/W
Rthj-a	Maximum Thermal Resistance, Junction-ambient	110	°C/W



AP4525GEH

N-CH Electrical Characteristics @ $T_j=25^\circ\text{C}$ (unless otherwise specified)

Symbol	Parameter	Test Conditions	Min.	Typ.	Max.	Units
BV_{DSS}	Drain-Source Breakdown Voltage	$V_{GS}=0V, I_D=250\mu A$	40	-	-	V
$\Delta BV_{DSS}/\Delta T_j$	Breakdown Voltage Temperature Coefficient	Reference to 25°C , $I_D=1\text{mA}$	-	0.03	-	V/°C
$R_{DS(ON)}$	Static Drain-Source On-Resistance ²	$V_{GS}=10V, I_D=6A$	-	-	28	mΩ
		$V_{GS}=4.5V, I_D=4A$	-	-	32	mΩ
$V_{GS(th)}$	Gate Threshold Voltage	$V_{DS}=V_{GS}, I_D=250\mu A$	1	-	3	V
g_{fs}	Forward Transconductance	$V_{DS}=10V, I_D=6A$	-	6	-	S
I_{DSS}	Drain-Source Leakage Current	$V_{DS}=40V, V_{GS}=0V$	-	-	1	μA
	Drain-Source Leakage Current ($T_j=70^\circ\text{C}$)	$V_{DS}=32V, V_{GS}=0V$	-	-	25	μA
I_{GSS}	Gate-Source Leakage	$V_{GS}=\pm 16V$	-	-	±30	μA
Q_g	Total Gate Charge ²	$I_D=6A$	-	9	14	nC
Q_{gs}	Gate-Source Charge	$V_{DS}=20V$	-	1.5	-	nC
Q_{gd}	Gate-Drain ("Miller") Charge	$V_{GS}=4.5V$	-	4	-	nC
$t_{d(on)}$	Turn-on Delay Time ²	$V_{DS}=20V$	-	7	-	ns
t_r	Rise Time	$I_D=6A$	-	20	-	ns
$t_{d(off)}$	Turn-off Delay Time	$R_G=3\Omega, V_{GS}=10V$	-	20	-	ns
t_f	Fall Time	$R_D=3.3\Omega$	-	4	-	ns
C_{iss}	Input Capacitance	$V_{GS}=0V$	-	580	930	pF
C_{oss}	Output Capacitance	$V_{DS}=25V$	-	100	-	pF
C_{riss}	Reverse Transfer Capacitance	$f=1.0\text{MHz}$	-	70	-	pF
R_g	Gate Resistance	$f=1.0\text{MHz}$	-	2	3	Ω

Source-Drain Diode

Symbol	Parameter	Test Conditions	Min.	Typ.	Max.	Units
V_{SD}	Forward On Voltage ²	$I_S=15A, V_{GS}=0V$	-	-	1.8	V
t_{rr}	Reverse Recovery Time ²	$I_S=6A, V_{GS}=0V$	-	20	-	ns
Q_{rr}	Reverse Recovery Charge	$dI/dt=100A/\mu s$	-	15	-	nC

**P-CH Electrical Characteristics @T_j=25°C(unless otherwise specified)**

Symbol	Parameter	Test Conditions	Min.	Typ.	Max.	Units
BV _{DSS}	Drain-Source Breakdown Voltage	V _{GS} =0V, I _D =-250uA	-40	-	-	V
ΔBV _{DSS} /ΔT _j	Breakdown Voltage Temperature Coefficient	Reference to 25°C, I _D =-1mA	-	-0.03	-	V/°C
R _{DS(ON)}	Static Drain-Source On-Resistance ²	V _{GS} =-10V, I _D =-5A	-	-	42	mΩ
		V _{GS} =-4.5V, I _D =-3A	-	-	60	mΩ
V _{GS(th)}	Gate Threshold Voltage	V _{DS} =V _{GS} , I _D =-250uA	-0.8	-	-2.5	V
g _{fs}	Forward Transconductance	V _{DS} =-10V, I _D =-5A	-	5	-	S
I _{DSS}	Drain-Source Leakage Current	V _{DS} =-40V, V _{GS} =0V	-	-	-1	uA
	Drain-Source Leakage Current (T _j =70°C)	V _{DS} =-32V, V _{GS} =0V	-	-	-25	uA
I _{GSS}	Gate-Source Leakage	V _{GS} =±16V	-	-	±30	uA
Q _g	Total Gate Charge ²	I _D =-5A	-	9	24	nC
Q _{gs}	Gate-Source Charge	V _{DS} =-20V	-	2	-	nC
Q _{gd}	Gate-Drain ("Miller") Charge	V _{GS} =-4.5V	-	5	-	nC
t _{d(on)}	Turn-on Delay Time ²	V _{DS} =-20V	-	8.5	-	ns
t _r	Rise Time	I _D =-5A	-	15	-	ns
t _{d(off)}	Turn-off Delay Time	R _G =3Ω, V _{GS} =-10V	-	27	-	ns
t _f	Fall Time	R _D =4Ω	-	25	-	ns
C _{iss}	Input Capacitance	V _{GS} =0V	-	770	1230	pF
C _{oss}	Output Capacitance	V _{DS} =-20V	-	165	-	pF
C _{rss}	Reverse Transfer Capacitance	f=1.0MHz	-	115	-	pF
R _g	Gate Resistance	f=1.0MHz	-	6	9	Ω

Source-Drain Diode

Symbol	Parameter	Test Conditions	Min.	Typ.	Max.	Units
V _{SD}	Forward On Voltage ²	I _S =-12A, V _{GS} =0V	-	-	-1.8	V
t _{rr}	Reverse Recovery Time ²	I _S =-5A, V _{GS} =0V	-	20	-	ns
Q _{rr}	Reverse Recovery Charge	di/dt=-100A/μs	-	16	-	nC

Notes:

- 1.Pulse width limited by Max. junction temperature.
- 2.Pulse width ≤300us , duty cycle ≤2%.
- 3.N-CH , P-CH are same .

THIS PRODUCT IS SENSITIVE TO ELECTROSTATIC DISCHARGE, PLEASE HANDLE WITH CAUTION.

USE OF THIS PRODUCT AS A CRITICAL COMPONENT IN LIFE SUPPORT OR OTHER SIMILAR SYSTEMS IS NOT AUTHORIZED.

APEC DOES NOT ASSUME ANY LIABILITY ARISING OUT OF THE APPLICATION OR USE OF ANY PRODUCT OR CIRCUIT DESCRIBED HEREIN; NEITHER DOES IT CONVEY ANY LICENSE UNDER ITS PATENT RIGHTS, NOR THE RIGHTS OF OTHERS.

APEC RESERVES THE RIGHT TO MAKE CHANGES WITHOUT FURTHER NOTICE TO ANY PRODUCTS HEREIN TO IMPROVE RELIABILITY, FUNCTION OR DESIGN.



AP4525GEH

N-Channel

www.datasheet4u.com

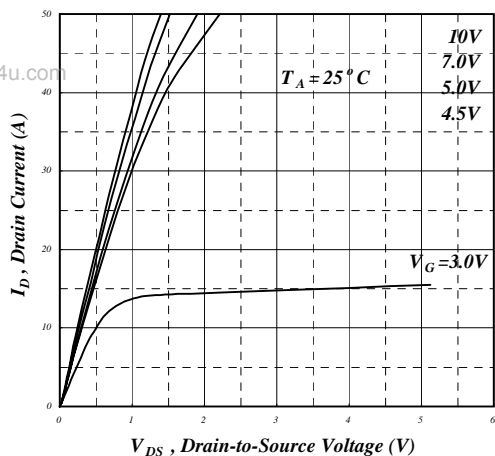

Fig 1. Typical Output Characteristics

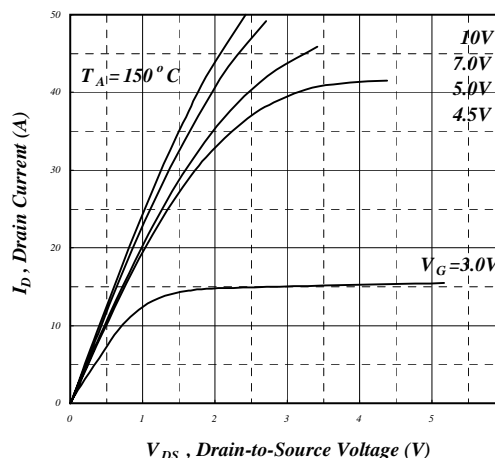

Fig 2. Typical Output Characteristics

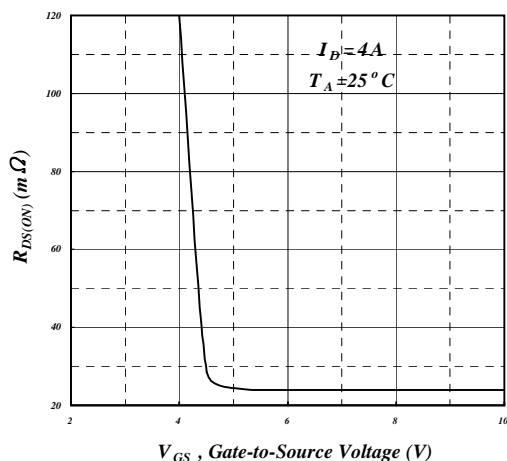

Fig 3. On-Resistance v.s. Gate Voltage

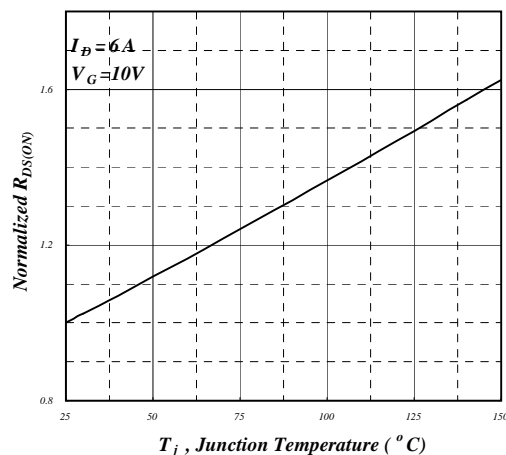

Fig 4. Normalized On-Resistance v.s. Junction Temperature

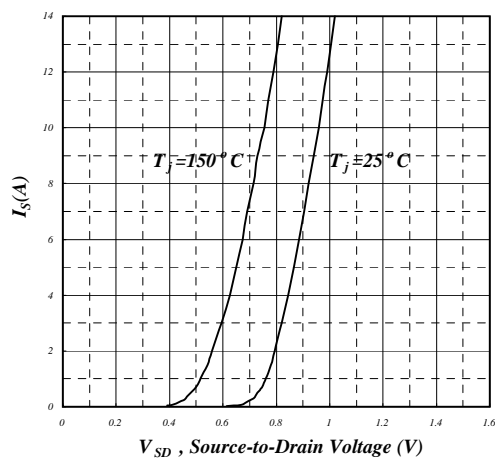

Fig 5. Forward Characteristic of Reverse Diode

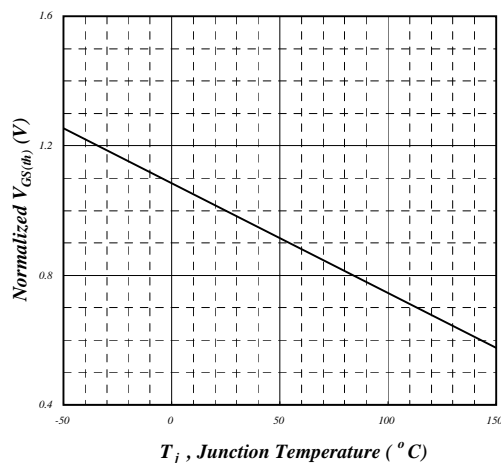

Fig 6. Gate Threshold Voltage v.s. Junction Temperature



N-Channel

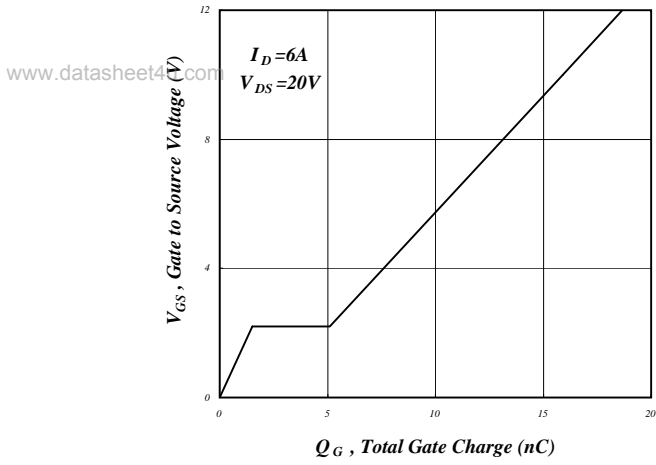

Fig 7. Gate Charge Characteristics

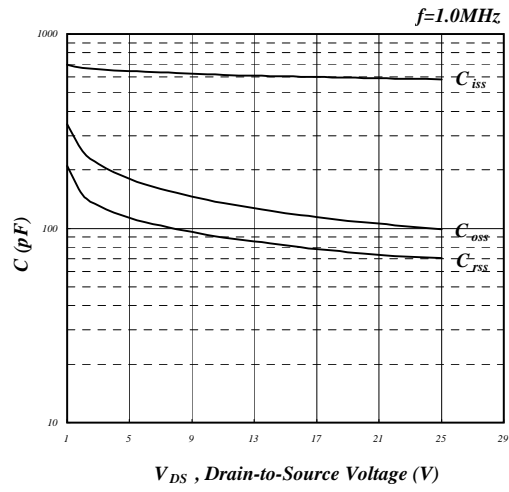

Fig 8. Typical Capacitance Characteristics

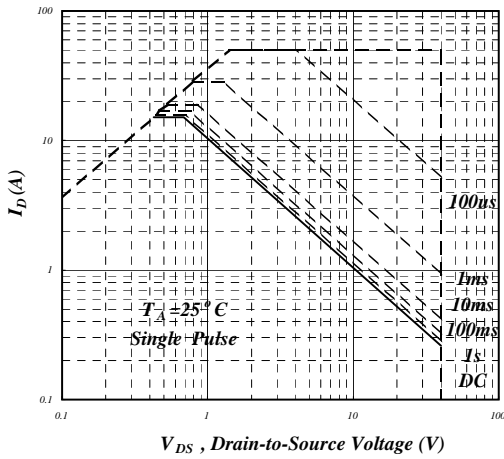

Fig 9. Maximum Safe Operating Area

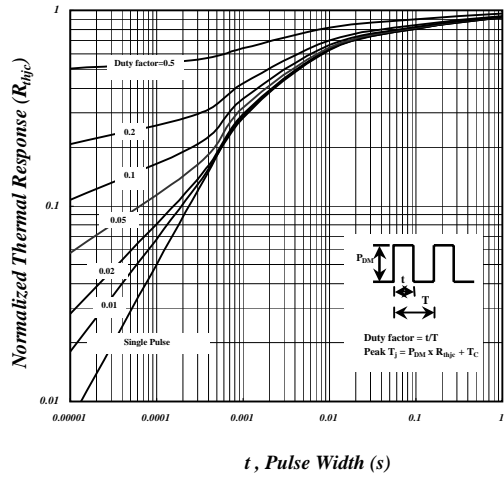

Fig 10. Effective Transient Thermal Impedance

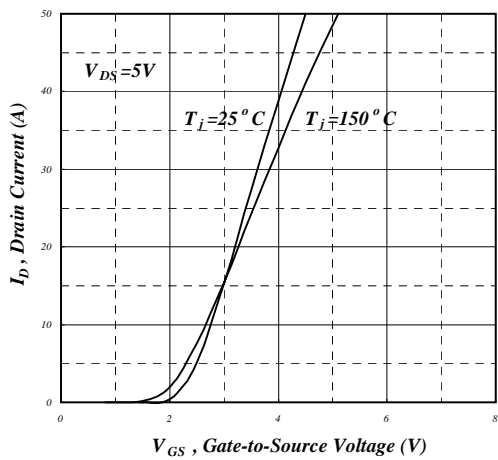

Fig 11. Transfer Characteristics

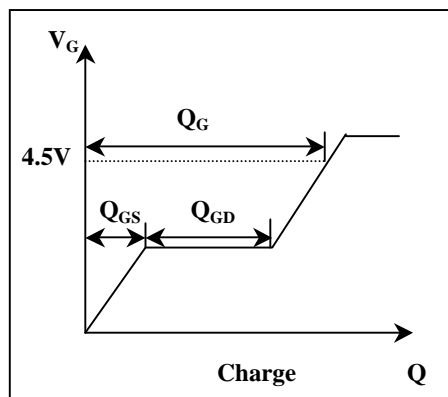

Fig 12. Gate Charge Waveform



AP4525GEH

P-Channel

www.datasheet4u.com

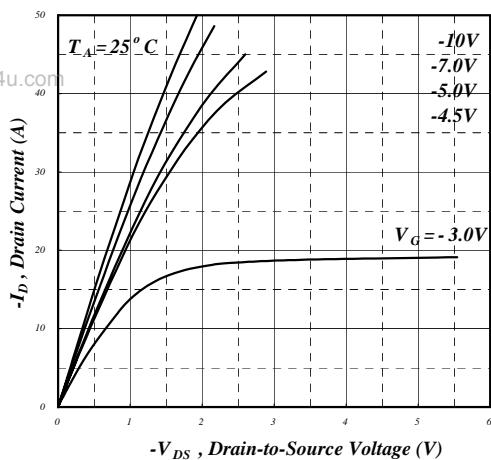

Fig 1. Typical Output Characteristics

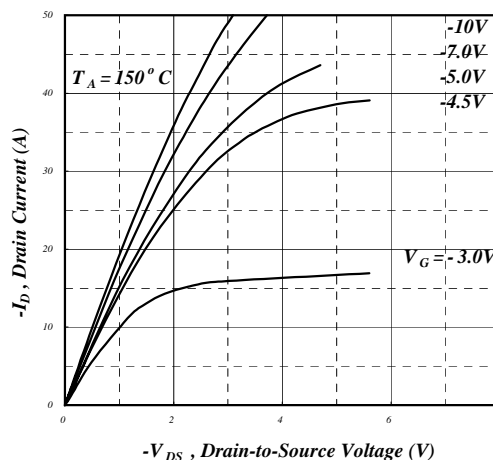

Fig 2. Typical Output Characteristics

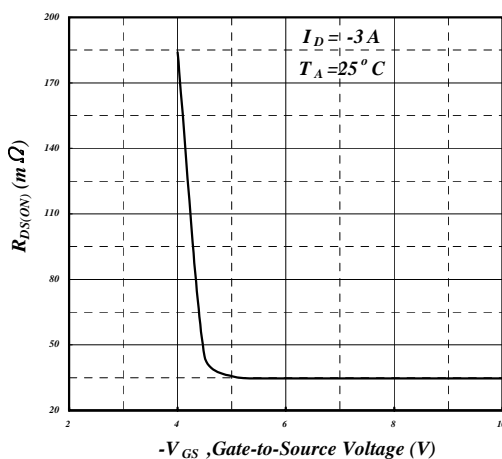

Fig 3. On-Resistance v.s. Gate Voltage

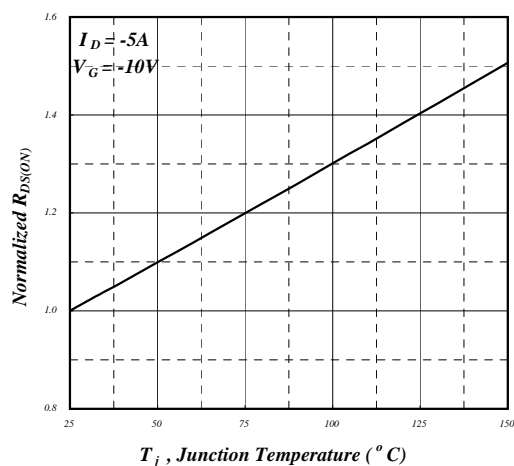

Fig 4. Normalized On-Resistance v.s. Junction Temperature

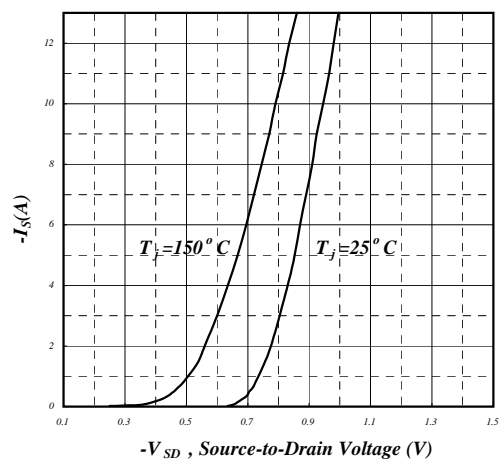

Fig 5. Forward Characteristic of Reverse Diode

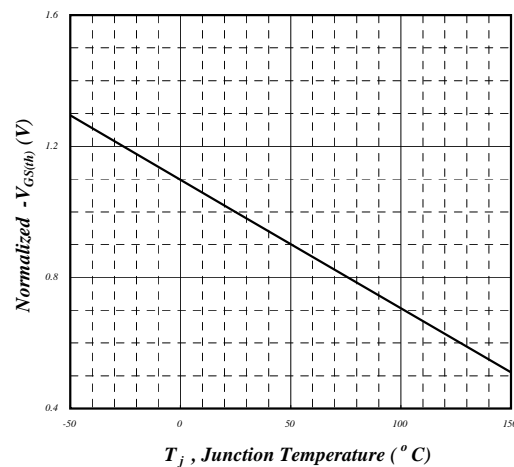

Fig 6. Gate Threshold Voltage v.s. Junction Temperature



P-Channel

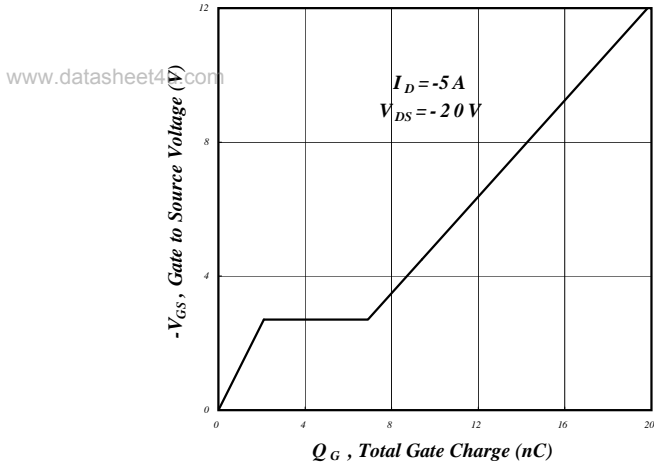

Fig 7. Gate Charge Characteristics

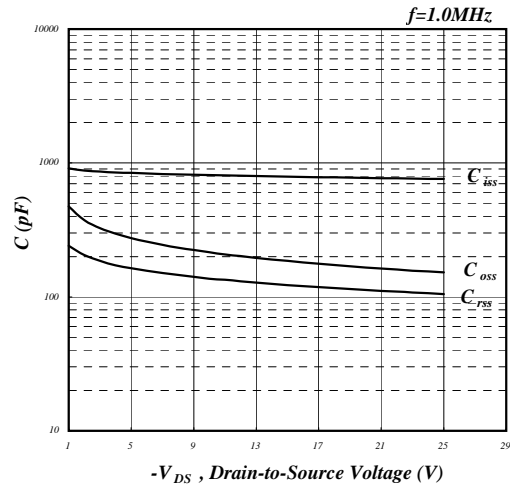

Fig 8. Typical Capacitance Characteristics

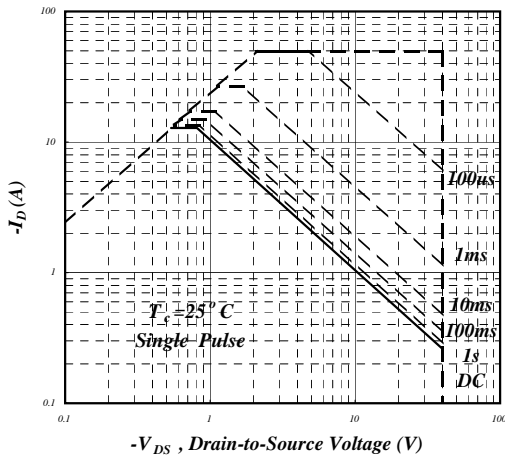

Fig 9. Maximum Safe Operating Area

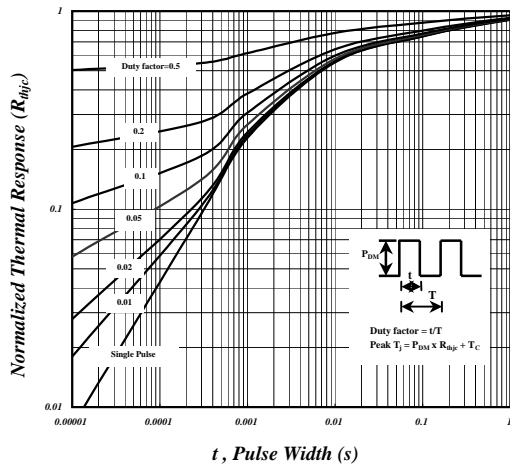

Fig 10. Effective Transient Thermal Impedance

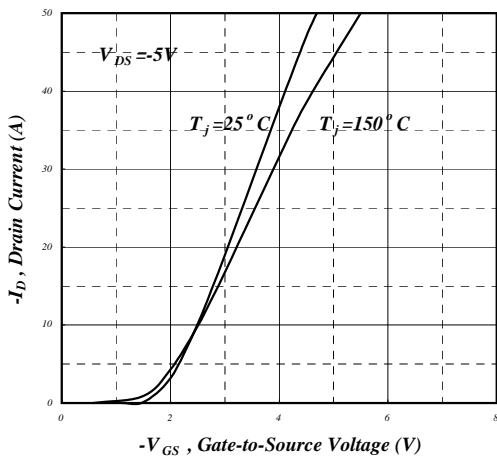

Fig 11. Transfer Characteristics

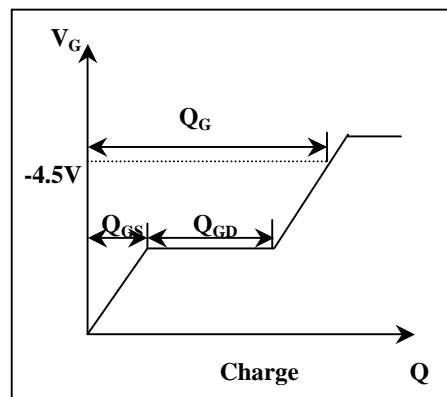
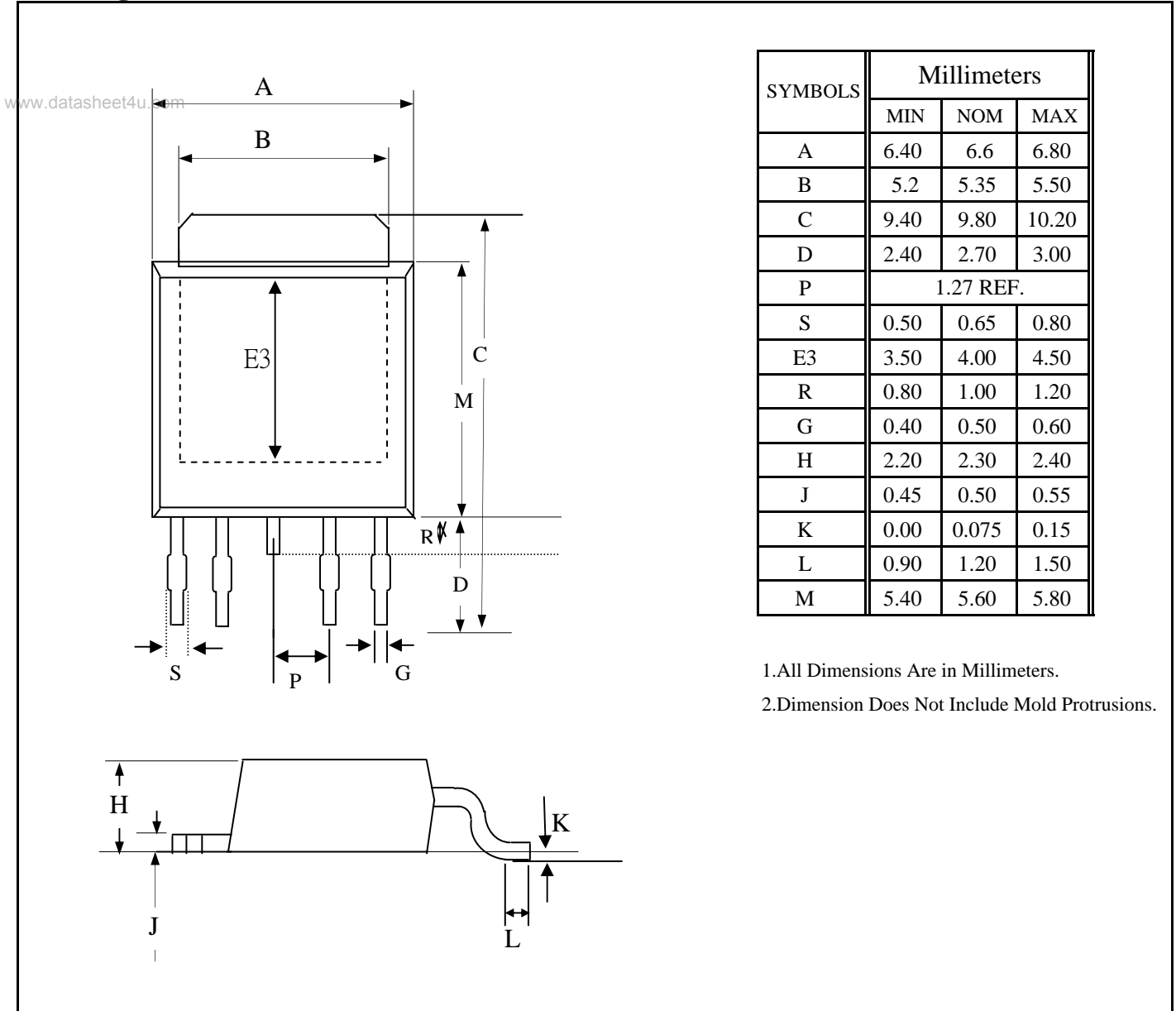

Fig 12. Gate Charge Waveform



Package Outline : TO-252(4L)



SYMBOLS	Millimeters		
	MIN	NOM	MAX
A	6.40	6.6	6.80
B	5.2	5.35	5.50
C	9.40	9.80	10.20
D	2.40	2.70	3.00
P	1.27 REF.		
S	0.50	0.65	0.80
E3	3.50	4.00	4.50
R	0.80	1.00	1.20
G	0.40	0.50	0.60
H	2.20	2.30	2.40
J	0.45	0.50	0.55
K	0.00	0.075	0.15
L	0.90	1.20	1.50
M	5.40	5.60	5.80

- 1.All Dimensions Are in Millimeters.
- 2.Dimension Does Not Include Mold Protrusions.

Part Marking Information & Packing : TO-252(4L)

