

MODEL: TV 2180MK6

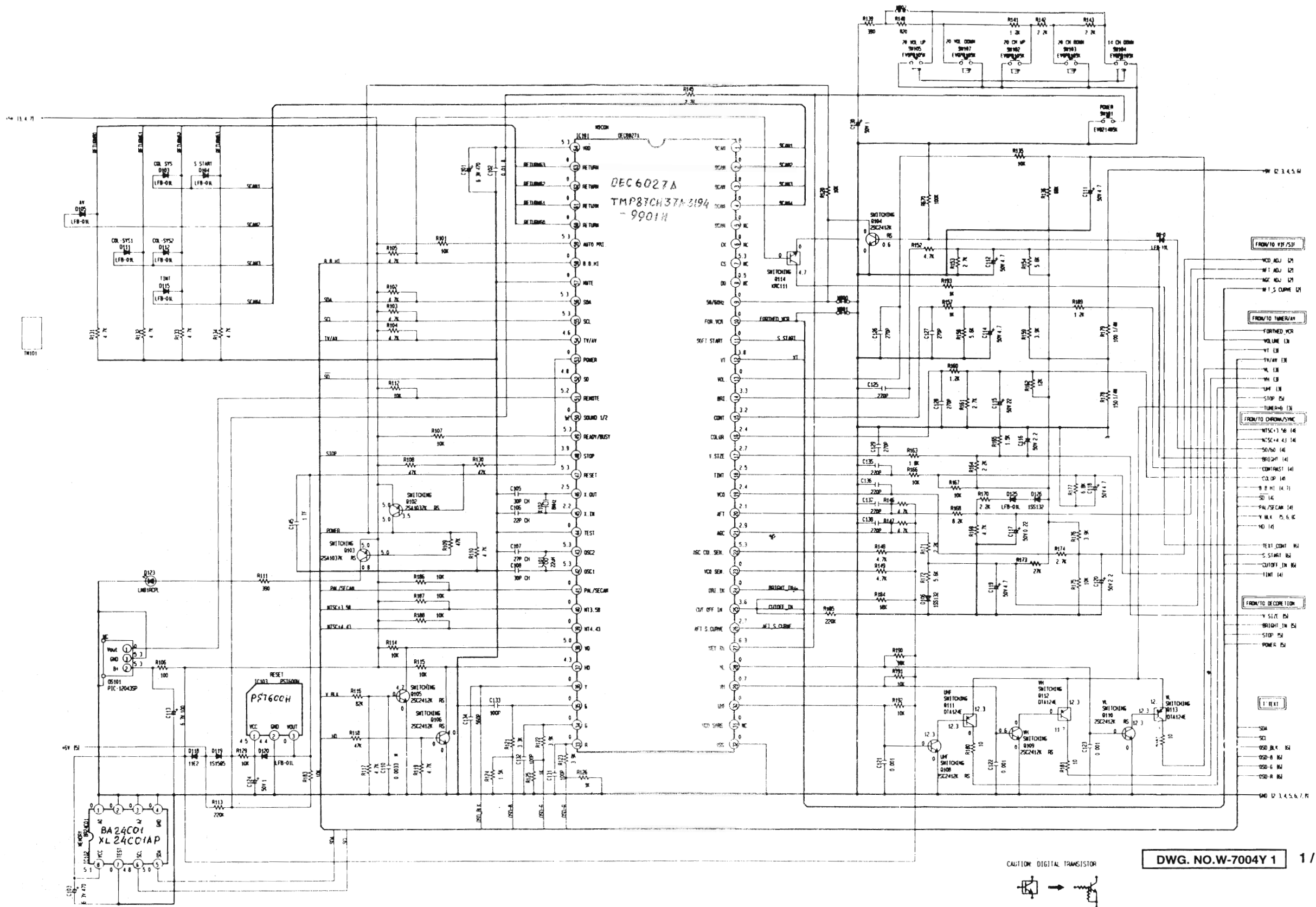

DWG. NO. W-7004Y 1 1 / 8

CAUTION: DIGITAL TRANSISTOR



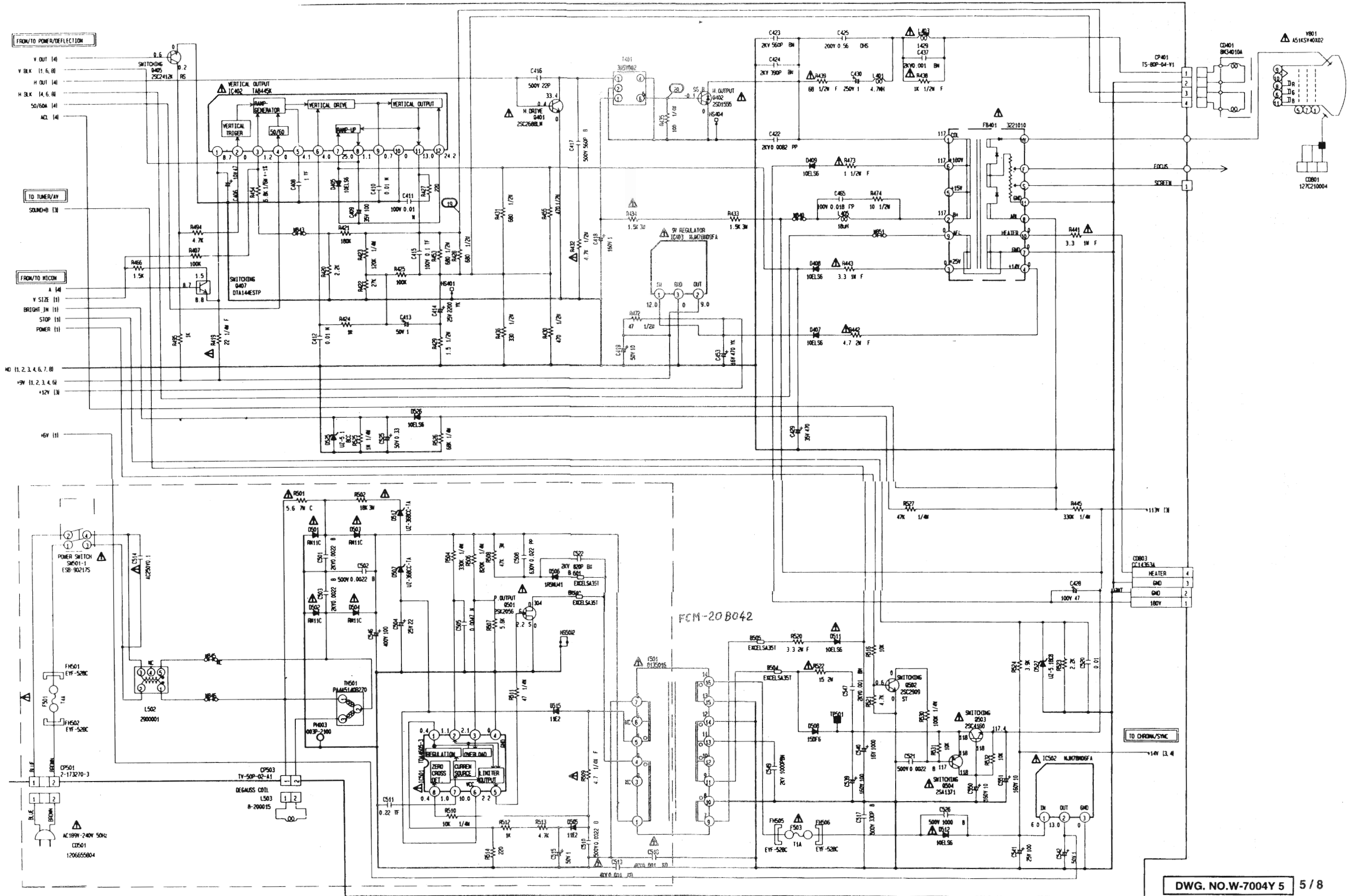

27

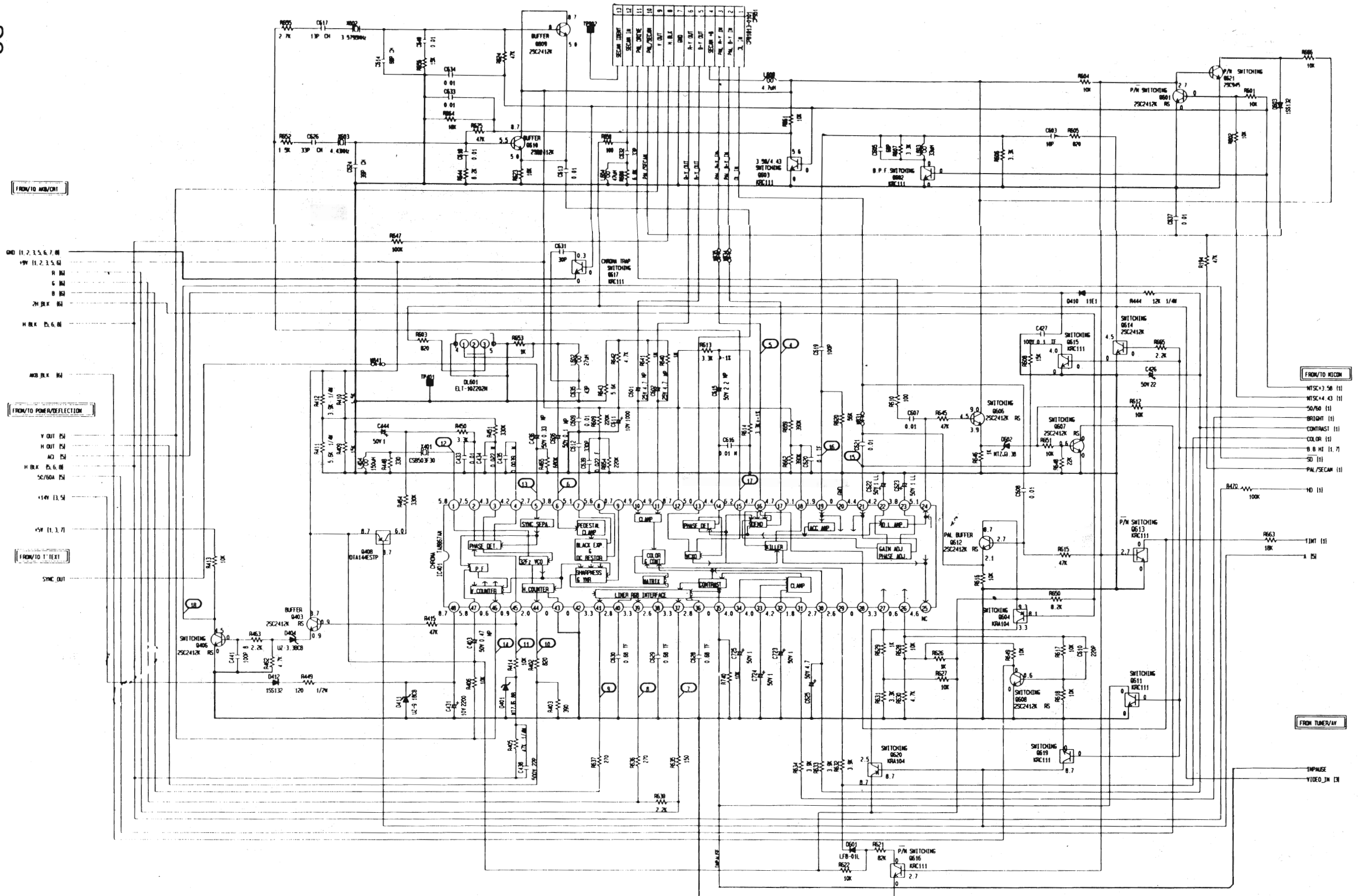

CAUTION: DIGITAL TRANSISTOR

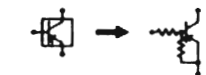

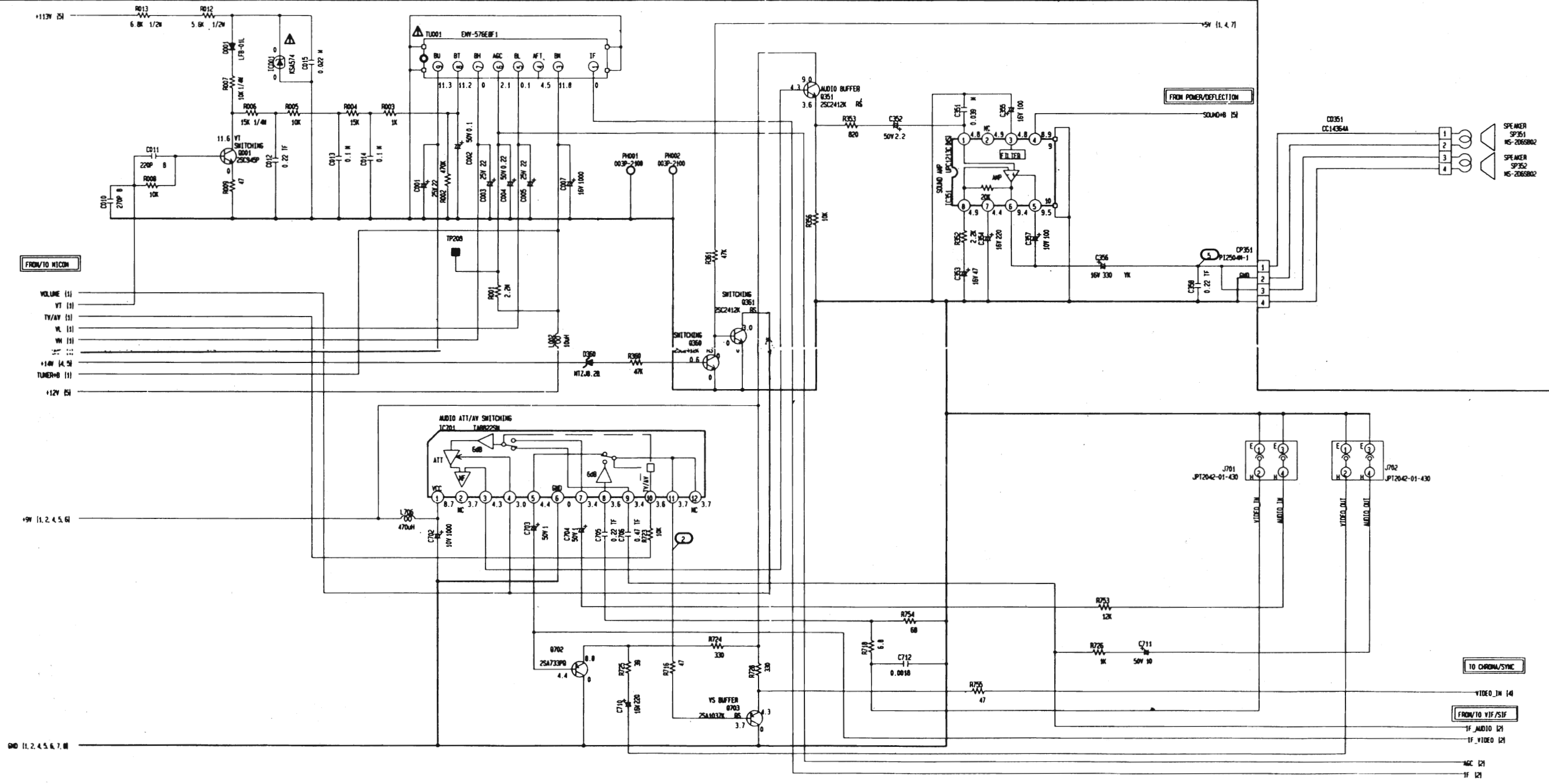
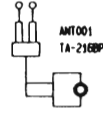

29

FROM TO AKB/CRT

TEXT CONT 111

- S START 111
- CUTOFF_IM 111
- GND 11, 2, 3, 4, 5, 7, 8
- +5V 11, 2, 3, 4, 5
- R 14
- G 14
- B 14
- 2H_BULK 14
- V_BULK 11, 5, 8
- H_BULK 14, 5, 8
- TEXT-R
- TEXT-G
- TEXT-B
- TEXT_BULK
- AKB_BULK 14
- OSD_BULK 111
- OSD-R 111
- SW-R
- OSD-G 111
- SW-G
- OSD-B 111
- SW-B 171

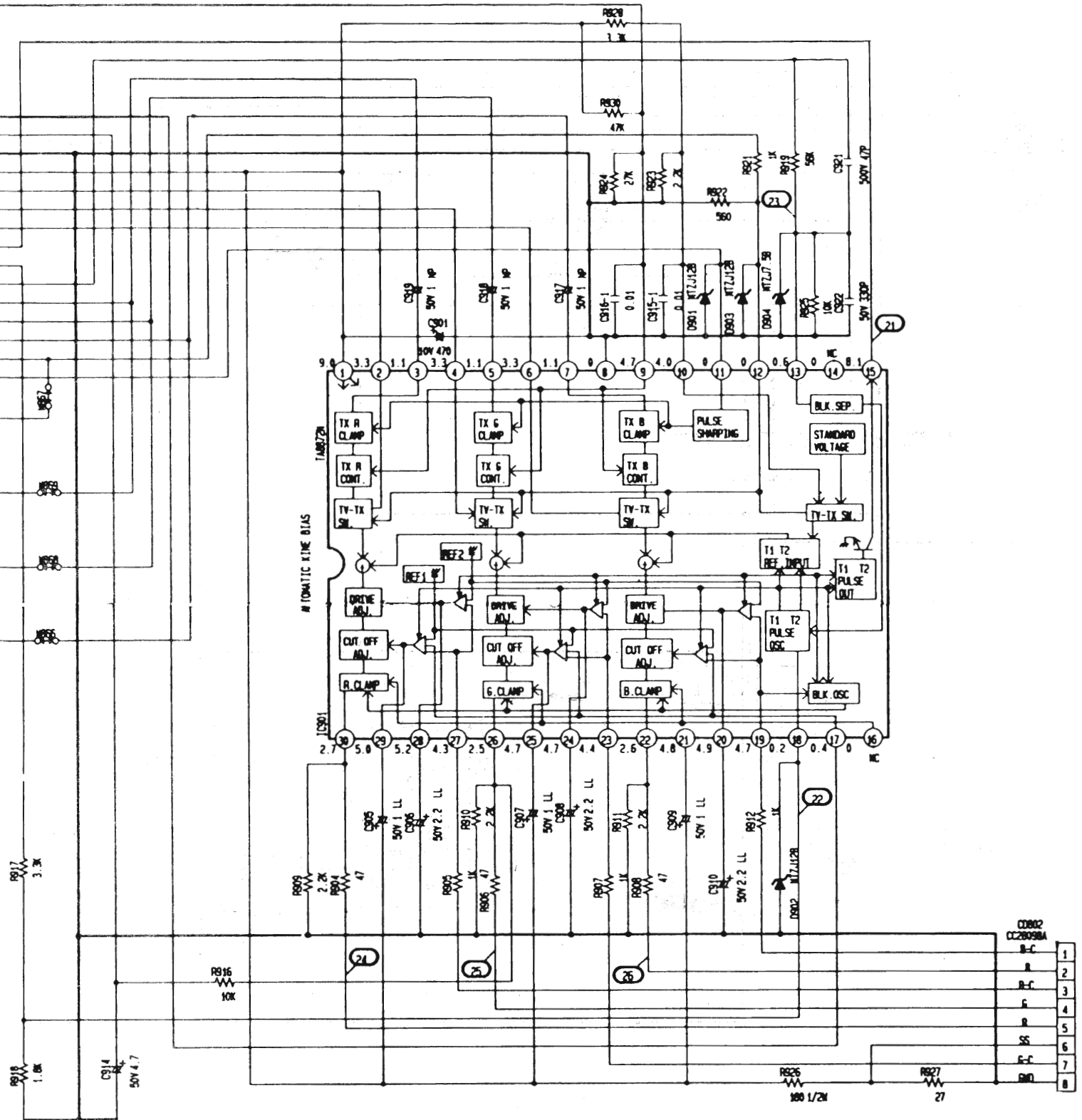

0951-A
 0989813-0101

1 D.J.N
 2 PM B-Y LN
 3 PM B-Y LN
 4 SW
 5 B-Y OUT
 6 B-Y OUT
 7 SW
 8 H.R.X
 9 Y.M.X
 10 PM JIBENT
 11 PM JIBENT
 12 SECAN LN
 13 TRER JNL

10 3/8
 10 MAIN PCB

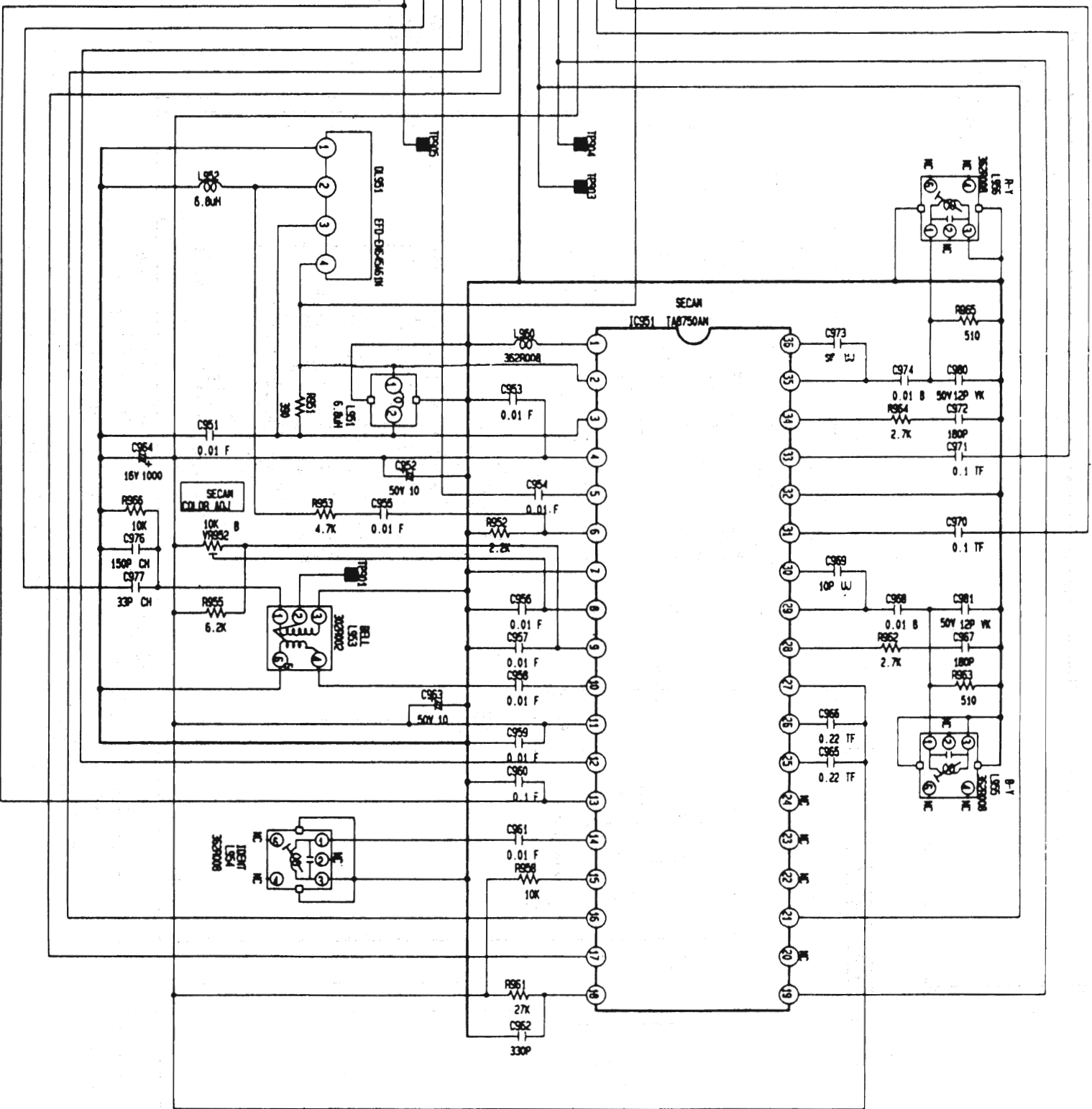

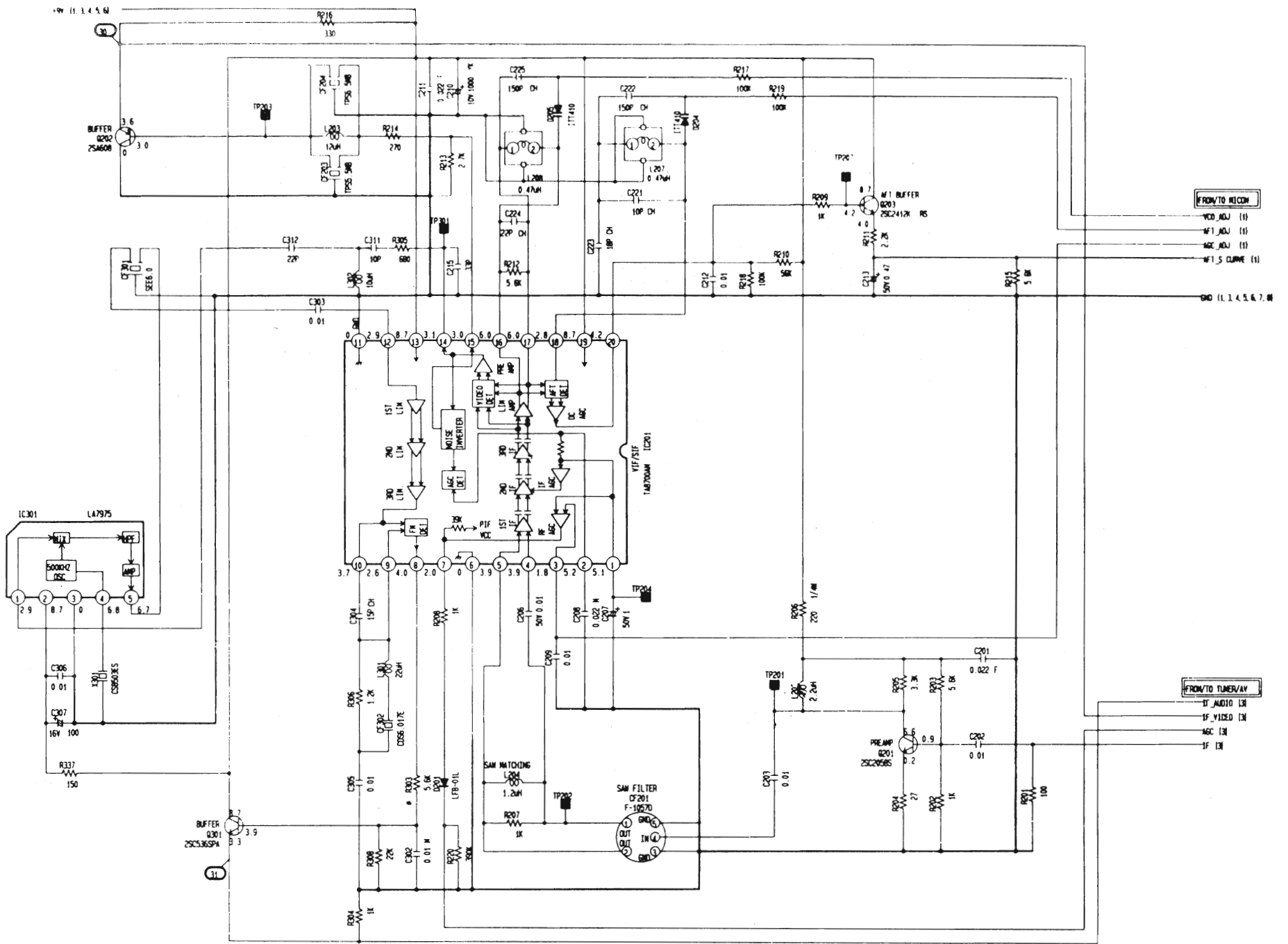

DWG. NO.W-7004Y 2 2 / 8

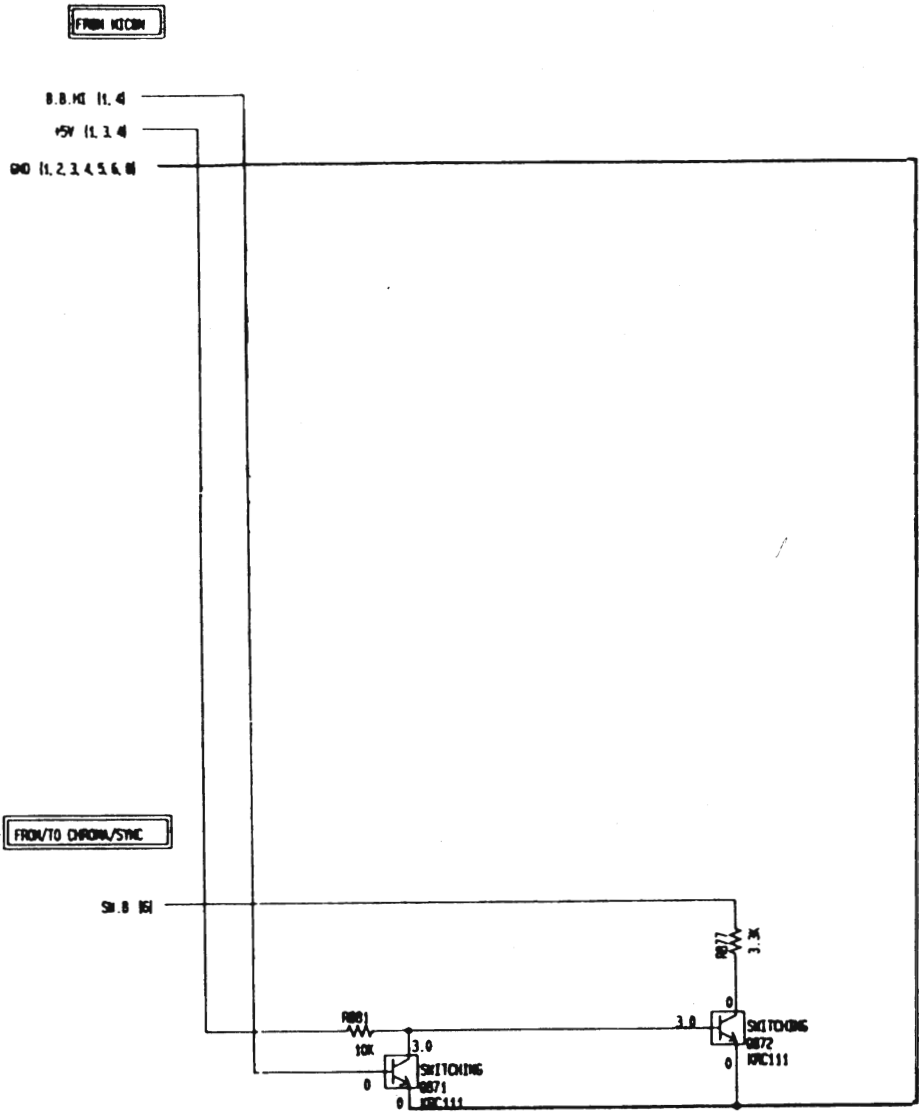

DWG. NO.W-7004Y 7 7 / 8