

Power Distribution Switch

Features

- 70mΩ High-Side MOSFET (G524A,G524B,G524C,G524D)
- Available with 4 Versions of Current Limits with Foldback
- Operating Range:2.7V to 5.5V
- 1mS Typical Rise Time
- Fast Overcurrent Response -1.5μs (TYPICAL)
- Under voltage Lockout
- 130μA Quiescent Supply Current
- 1μA Maximum Shutdown Supply Current
- Logic Level Enable Pin, Available with Active-High or Active-Low Version
- No Reverse Current when Power Off
- Deglitched Open-Drain Over-Current Flag Output (\overline{OC})
- Available with or without Output Shutdown Pull-low Resistor
- Output Reverse-Voltage Protection
- SOT-23-5, TSOT-23-6, MSOP-8 and MSOP-8 (FD) Packages
- UL Certification_#E232223
- CB Test Certification by IEC 60950-1:2005 (2nd Edition); Am 1:2009 + Am 2:2013

General Description

The G524 is an integrated power switch for self-powered and bus-powered Universal Serial Bus (USB) applications. G524A, G524B, G524C, G524D are 70mΩ $R_{DS(ON)}$.

Several Protection features include current limiting and thermal shutdown to prevent catastrophic switch failure caused by increasing power dissipation when continuous heavy loads or short circuit occurs. A built-in charge pump is used to drive the N-channel MOSFET that is free of parasitic body diode to eliminate any reversed current flow across the switch when it is powered off. When the output voltage is higher than input voltage, the power switch is turned off by internal output reverse-voltage comparator.

\overline{OC} is an open-drain output report over-current or over-temperature event and has typical 9ms deglitch timeout period. In addition, \overline{OC} (G524X3/4, X=A, B, C, D) also reports output reverse-voltage condition with typical 5ms deglitch timeout period.

Applications

- High-Side Power Protection Switch
- USB Power Management
- USB Host and Self-Powered Bubs
- USB Bus-Powered Hubs
- Hot Plug-In Power Supplies
- Battery-Charger Circuits

Pin Configuration

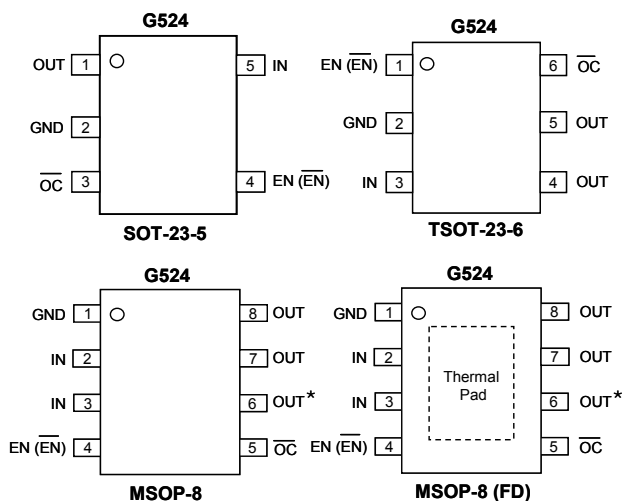

Note: Recommend connecting the Thermal Pad to the GND for excellent power dissipation.

* Pin#6 should be considered as OUT when circuit design and PCB layout, but it is NC pin actually.

Typical Application Circuit

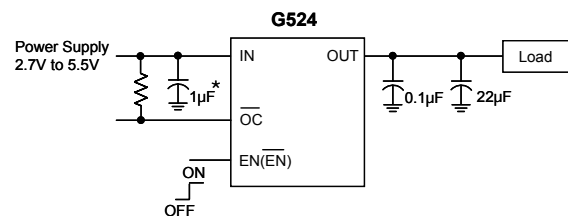

*: 1μF of input capacitor is enough in most application cases. If the PCB trace of power rail to IN is long, larger input capacitor is necessary.

Ordering Information

ORDER NUMBER	MARKING	ENABLE	Current Limit	Output MOS $R_{DS(ON)}$	Output Shutdown Resistor	TEMP. RANGE	PACKAGE (Green)
G524D1T11U	54D1x	Active High	1.5A	70mΩ	Yes	-40°C to +85°C	SOT-23-5
G524D2T11U	54D2x	Active Low	1.5A	70mΩ	Yes	-40°C to +85°C	SOT-23-5
G524D3T11U	54D3x	Active High	1.5A	70mΩ	No	-40°C to +85°C	SOT-23-5
G524D4T11U	54D4x	Active Low	1.5A	70mΩ	No	-40°C to +85°C	SOT-23-5
G524C1T11U	54C1x	Active High	2A	70mΩ	Yes	-40°C to +85°C	SOT-23-5
G524C2T11U	54C2x	Active Low	2A	70mΩ	Yes	-40°C to +85°C	SOT-23-5
G524C3T11U	54C3x	Active High	2A	70mΩ	No	-40°C to +85°C	SOT-23-5
G524C4T11U	54C4x	Active Low	2A	70mΩ	No	-40°C to +85°C	SOT-23-5
G524B1T11U	54B1x	Active High	2.5A	70mΩ	Yes	-40°C to +85°C	SOT-23-5
G524B2T11U	54B2x	Active Low	2.5A	70mΩ	Yes	-40°C to +85°C	SOT-23-5
G524B3T11U	54B3x	Active High	2.5A	70mΩ	No	-40°C to +85°C	SOT-23-5
G524B4T11U	54B4x	Active Low	2.5A	70mΩ	No	-40°C to +85°C	SOT-23-5
G524A1T11U	54A1x	Active High	2.1A	70mΩ	Yes	-40°C to +85°C	SOT-23-5
G524A2T11U	54A2x	Active Low	2.1A	70mΩ	Yes	-40°C to +85°C	SOT-23-5
G524A3T11U	54A3x	Active High	2.1A	70mΩ	No	-40°C to +85°C	SOT-23-5
G524A4T11U	54A4x	Active Low	2.1A	70mΩ	No	-40°C to +85°C	SOT-23-5
G524D1TP1U	54D1x	Active High	1.5A	70mΩ	Yes	-40°C to +85°C	TSOT-23-6
G524D2TP1U	54D2x	Active Low	1.5A	70mΩ	Yes	-40°C to +85°C	TSOT-23-6
G524D3TP1U	54D3x	Active High	1.5A	70mΩ	No	-40°C to +85°C	TSOT-23-6
G524D4TP1U	54D4x	Active Low	1.5A	70mΩ	No	-40°C to +85°C	TSOT-23-6
G524C1TP1U	54C1x	Active High	2A	70mΩ	Yes	-40°C to +85°C	TSOT-23-6
G524C2TP1U	54C2x	Active Low	2A	70mΩ	Yes	-40°C to +85°C	TSOT-23-6
G524C3TP1U	54C3x	Active High	2A	70mΩ	No	-40°C to +85°C	TSOT-23-6
G524C4TP1U	54C4x	Active Low	2A	70mΩ	No	-40°C to +85°C	TSOT-23-6
G524B1TP1U	54B1x	Active High	2.5A	70mΩ	Yes	-40°C to +85°C	TSOT-23-6
G524B2TP1U	54B2x	Active Low	2.5A	70mΩ	Yes	-40°C to +85°C	TSOT-23-6
G524B3TP1U	54B3x	Active High	2.5A	70mΩ	No	-40°C to +85°C	TSOT-23-6
G524B4TP1U	54B4x	Active Low	2.5A	70mΩ	No	-40°C to +85°C	TSOT-23-6
G524A1TP1U	54A1x	Active High	2.1A	70mΩ	Yes	-40°C to +85°C	TSOT-23-6
G524A2TP1U	54A2x	Active Low	2.1A	70mΩ	Yes	-40°C to +85°C	TSOT-23-6
G524A3TP1U	54A3x	Active High	2.1A	70mΩ	No	-40°C to +85°C	TSOT-23-6
G524A4TP1U	54A4x	Active Low	2.1A	70mΩ	No	-40°C to +85°C	TSOT-23-6
G524D1P81U	G524D1	Active High	1.5A	70mΩ	Yes	-40°C to +85°C	MSOP-8
G524D2P81U	G524D2	Active Low	1.5A	70mΩ	Yes	-40°C to +85°C	MSOP-8
G524D3P81U	G524D3	Active High	1.5A	70mΩ	No	-40°C to +85°C	MSOP-8
G524D4P81U	G524D4	Active Low	1.5A	70mΩ	No	-40°C to +85°C	MSOP-8
G524C1P81U	G524C1	Active High	2A	70mΩ	Yes	-40°C to +85°C	MSOP-8
G524C2P81U	G524C2	Active Low	2A	70mΩ	Yes	-40°C to +85°C	MSOP-8
G524C3P81U	G524C3	Active High	2A	70mΩ	No	-40°C to +85°C	MSOP-8
G524C4P81U	G524C4	Active Low	2A	70mΩ	No	-40°C to +85°C	MSOP-8
G524B1P81U	G524B1	Active High	2.5A	70mΩ	Yes	-40°C to +85°C	MSOP-8
G524B2P81U	G524B2	Active Low	2.5A	70mΩ	Yes	-40°C to +85°C	MSOP-8
G524B3P81U	G524B3	Active High	2.5A	70mΩ	No	-40°C to +85°C	MSOP-8
G524B4P81U	G524B4	Active Low	2.5A	70mΩ	No	-40°C to +85°C	MSOP-8
G524A1P81U	G524A1	Active High	2.1A	70mΩ	Yes	-40°C to +85°C	MSOP-8
G524A2P81U	G524A2	Active Low	2.1A	70mΩ	Yes	-40°C to +85°C	MSOP-8
G524A3P81U	G524A3	Active High	2.1A	70mΩ	No	-40°C to +85°C	MSOP-8
G524A4P81U	G524A4	Active Low	2.1A	70mΩ	No	-40°C to +85°C	MSOP-8

Ordering Information (Continued)

ORDER NUMBER	MARKING	ENABLE	Current Limit	Output MOS $R_{DS(ON)}$	Output Shutdown Resistor	TEMP. RANGE	PACKAGE (Green)
G524D1F51U	G524D1	Active High	1.5A	70m Ω	Yes	-40°C to +85°C	MSOP-8 (FD)
G524D2F51U	G524D2	Active Low	1.5A	70m Ω	Yes	-40°C to +85°C	MSOP-8 (FD)
G524D3F51U	G524D3	Active High	1.5A	70m Ω	No	-40°C to +85°C	MSOP-8 (FD)
G524D4F51U	G524D4	Active Low	1.5A	70m Ω	No	-40°C to +85°C	MSOP-8 (FD)
G524C1F51U	G524C1	Active High	2A	70m Ω	Yes	-40°C to +85°C	MSOP-8 (FD)
G524C2F51U	G524C2	Active Low	2A	70m Ω	Yes	-40°C to +85°C	MSOP-8 (FD)
G524C3F51U	G524C3	Active High	2A	70m Ω	No	-40°C to +85°C	MSOP-8 (FD)
G524C4F51U	G524C4	Active Low	2A	70m Ω	No	-40°C to +85°C	MSOP-8 (FD)
G524B1F51U	G524B1	Active High	2.5A	70m Ω	Yes	-40°C to +85°C	MSOP-8 (FD)
G524B2F51U	G524B2	Active Low	2.5A	70m Ω	Yes	-40°C to +85°C	MSOP-8 (FD)
G524B3F51U	G524B3	Active High	2.5A	70m Ω	No	-40°C to +85°C	MSOP-8 (FD)
G524B4F51U	G524B4	Active Low	2.5A	70m Ω	No	-40°C to +85°C	MSOP-8 (FD)
G524A1F51U	G524A1	Active High	2.1A	70m Ω	Yes	-40°C to +85°C	MSOP-8 (FD)
G524A2F51U	G524A2	Active Low	2.1A	70m Ω	Yes	-40°C to +85°C	MSOP-8 (FD)
G524A3F51U	G524A3	Active High	2.1A	70m Ω	No	-40°C to +85°C	MSOP-8 (FD)
G524A4F51U	G524A4	Active Low	2.1A	70m Ω	No	-40°C to +85°C	MSOP-8 (FD)

Note: T1: SOT-23-5 TP:TSOT-23-6 P8: MSOP-8 F5: MSOP-8 (FD)

1: Bonding Code

U: Tape & Reel

Green : Lead Free / Halogen Free.

Absolute Maximum Ratings

Supply Voltage (V_{IN})	-0.3V to 6V
Output Voltage (V_{OUT})	-0.3V to 6V
Output Current (I_{OUT})	Internally Limited
Enable Input (V_{EN})	-0.3V to 6V
OC Output (OC)	-0.3V to 6V
Thermal Resistance Junction to Ambient, (θ_{JA})*	
SOT-23-5	250°C/W
TSOT-23-6	250°C/W
MSOP-8	200°C/W
MSOP-8(FD)	190°C/W
Continuous Power Dissipation ($T_A = +25^\circ\text{C}$)*	
SOT-23-5	0.5W
TSOT-23-6	0.5W
MSOP-8	0.6W
MSOP-8(FD)	0.65W

Thermal Resistance Junction to Case, (θ_{JC})	
SOT-23-5	60°C/W
TSOT-23-6	60°C/W
MSOP-8	55°C/W
MSOP-8(FD)	35°C/W
Junction Temperature	150°C
Storage Temperature (T_S)	-65°C to +150°C
Reflow Temperature (soldering, 10sec)	260°C
ESD(HBM)	2KV
ESD(MM)	200V
ESD(CDM)	1KV
Output ESD Protection	4KV

Operating Ratings

Supply Voltage (V_{IN})	3V to 5.5V
Operating Temperature (T_A)	-40°C to +85°C

*Please refer to Minimum Footprint PCB Layout Section.

Electrical Characteristics

$V_{IN} = 5V$, $C_{IN} = 1\mu F$, $C_{OUT} = 1\mu F$, $R_L = 10\Omega$, $T_A = 25^\circ\text{C}$.

The device is not guaranteed to function outside its operating conditions. Parameters with MIN and/or MAX limits are 100% tested at +25°C, unless otherwise specified.

PARAMETER	CONDITION	MIN	TYP	MAX	UNITS	
Input Voltage Range		2.7	---	5.5	V	
Output MOS $R_{DS(ON)}$	G524A1/G524A2/G524A3/G524A4, $I_{OUT} = 1.6A$	---	70	85	m Ω	
	G524B1/G524B2/G524B3/G524B4, $I_{OUT} = 2.0A$					
	G524C1/G524C2/G524C3/G524C4, $I_{OUT} = 1.5A$					
	G524D1/G524D2/G524D3/G524D4, $I_{OUT} = 1.0A$					
Supply Current	EN=Enable, $V_{OUT} = V_{IN} = 5V$ @ $I_{OUT} = 0A$	---	130	190	μA	
Output Turn-on Rising Time	$R_L = 10\Omega$, 90% Settling	$V_{IN} = 5V$	1	1.4	1.8	ms
		$V_{IN} = 3.3V$	1.6	2	2.4	
Over Current Trigger Point	G524A1/G524A2/G524A3/G524A4	1.9	2.1	2.4	A	
	G524B1/G524B2/G524B3/G524B4	2.2	2.5	2.8		
	G524C1/G524C2/G524C3/G524C4	1.7	2	2.3		
	G524D1/G524D2/G524D3/G524D4	1.2	1.5	1.8		
Fold-Back Current	G524A1/G524A2/G524A3/G524A4, $V_{IN} > 3.5V$ and $V_{OUT} < 1V$	0.9	1.4	2	A	
	G524B1/G524B2/G524B3/G524B4, $V_{IN} > 3.5V$ and $V_{OUT} < 1V$	1	1.6	2.3		
	G524C1/G524C2/G524C3/G524C4, $V_{IN} > 3.5V$ and $V_{OUT} < 1V$	0.8	1.3	1.8		
	G524D1/G524D2/G524D3/G524D4, $V_{IN} > 3.5V$ and $V_{OUT} < 1V$	0.6	1	1.4		
EN Input Threshold-High V_{IH}		1.2	---	---	V	
EN Input Threshold-Low V_{IL}		---	---	0.6	V	
Shutdown Supply Current	EN=Disable, $V_{OUT} = \text{"OPEN"}$	---	0.1	1	μA	
Shutdown Pull Low Resistance	EN=Disable	---	150	---	Ω	
Output Leakage Current	EN=Disable, $V_{OUT} = 5V$	---	0.5	1	μA	
V_{IN} Under Voltage Lockout		2.2	2.4	2.6	V	
Thermal Limit		---	140	---	$^\circ\text{C}$	
Thermal Limit Hysteresis		---	20	---	$^\circ\text{C}$	
OC Deglitch	OC assertion or deassertion	4	9	15	ms	
Output Reverse-Voltage Trigger Point ($V_{OUT} - V_{IN}$)	$V_{IN} = 5V$, G524X1/2, X=A, B, C, D	20	30	---	mV	
	G524X3/4, X=A, B, C, D	10	20	---	mV	
Output Reverse-current Trigger Point	G524X1/2, X=A, B, C, D	400	600	---	mA	
	G524X3/4, X=A, B, C, D	200	400	---	mA	
Output Reverse-Voltage Deglitch Time	$V_{IN} = 5V$	---	5	---	ms	
t_{IOS} Response Time to Short Circuit	$V_{IN} = 5V$, see figure 1,2	---	1.5	3.5	μs	

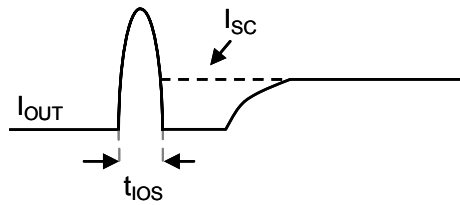

Figure 1

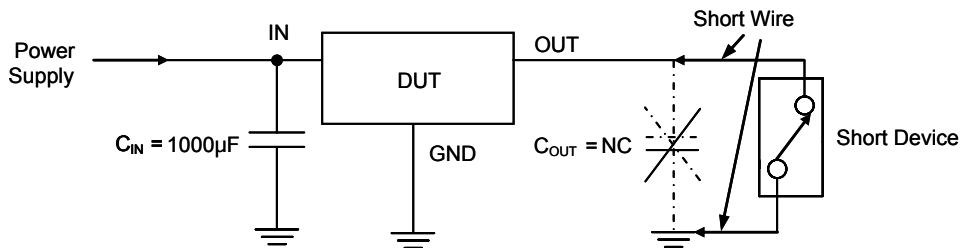

Figure 2

Note:

To exactly identify the short circuit characteristic of IC, avoid the test result interfered by parasitic inductor, output capacitor, and contact resistor. It is necessary to follow the recommendation as follows.

Please,

1. Add 1000µF of capacitor between V_{IN} and GND, and close to IC.
2. Remove output capacitor.
3. Shorter the short circuit device wire.
4. Measure output current (I_{OUT}).

Minimum Footprint PCB Layout Section

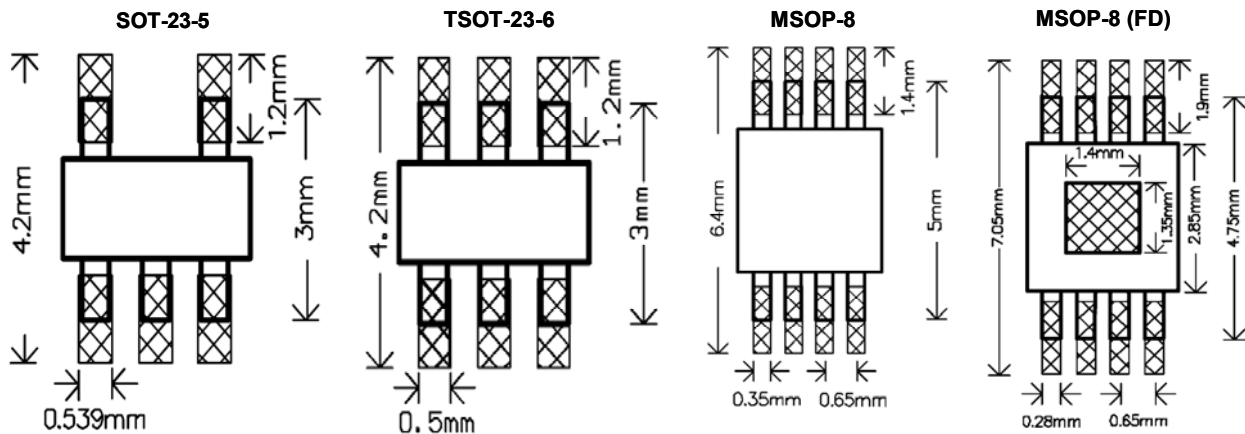

Typical Performance Characteristics

G524B1P81U, $V_{IN} = 5V$, $C_{IN} = 1\mu F$, $C_{OUT} = 1\mu F$, $T_A = 25^\circ C$, unless otherwise noted.

Supply Current vs. Input Voltage

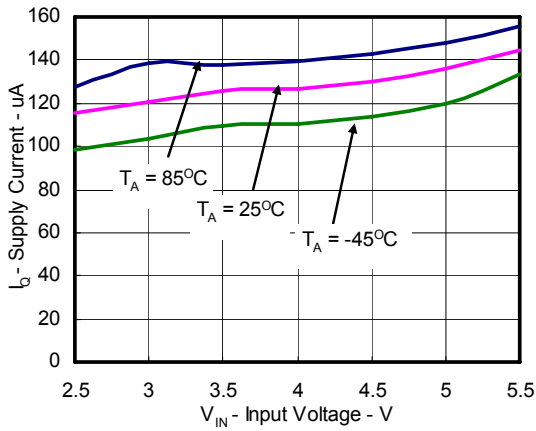

Shutdown Supply Current vs. Input Voltage

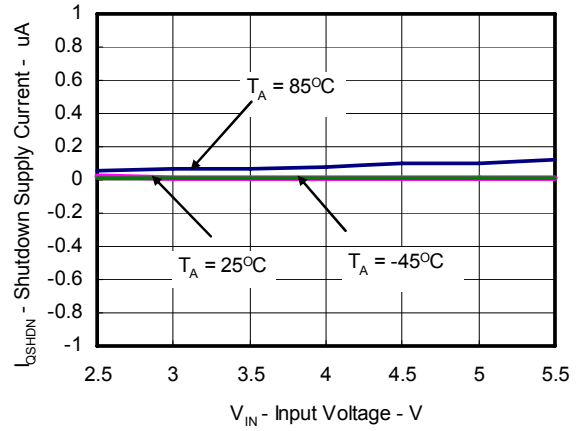

Enable Input Threshold vs. Input Voltage

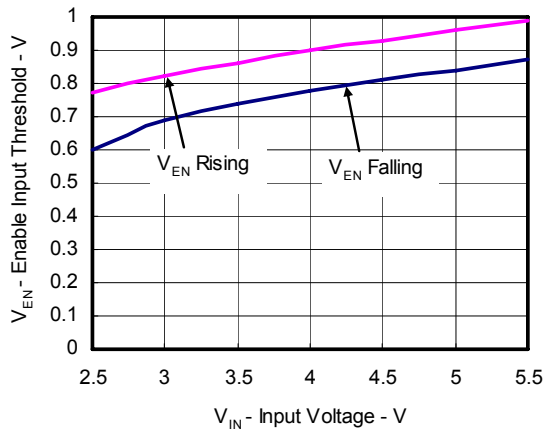

Enable Input Threshold vs. Temperature

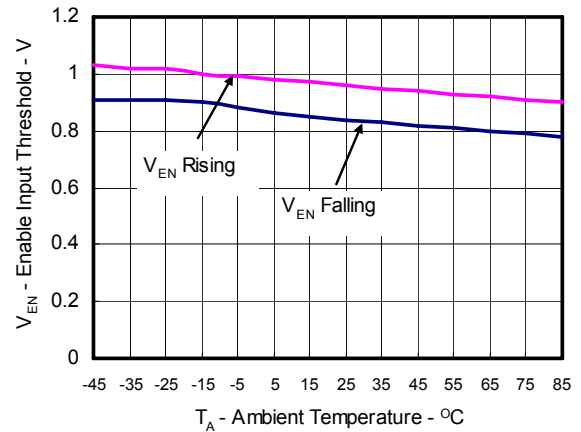

OC Deglitch Time vs. Input Voltage

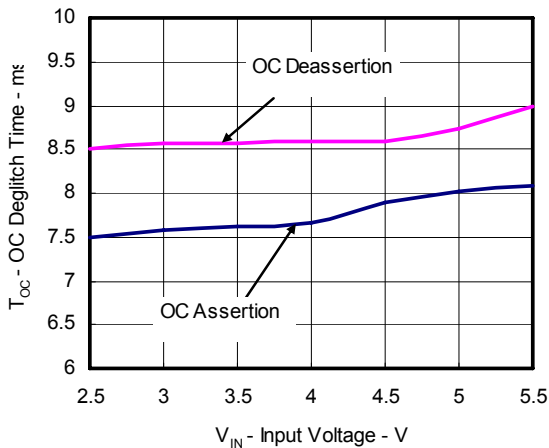

UVLO Threshold vs. Temperature

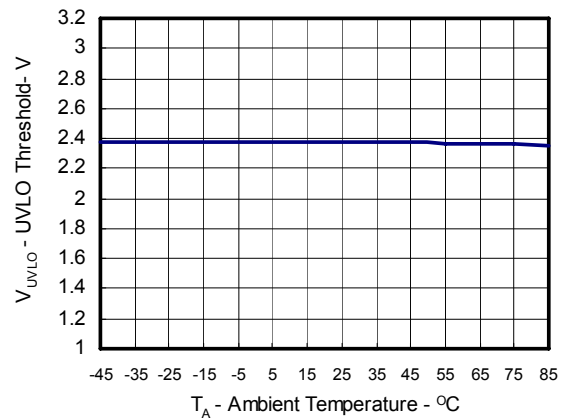

Typical Performance Characteristics (continued)

ON-Resistance vs. Input Voltage

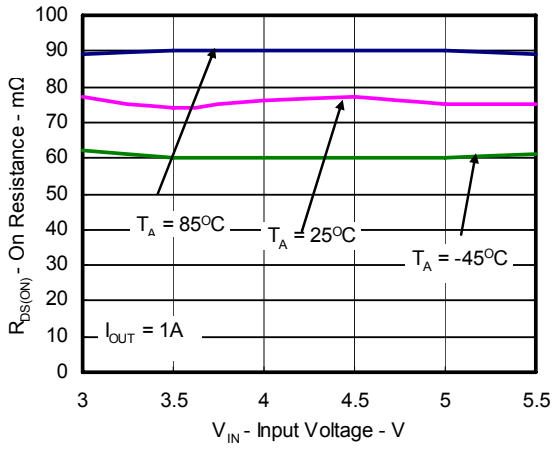

ON-Resistance vs. Temperature

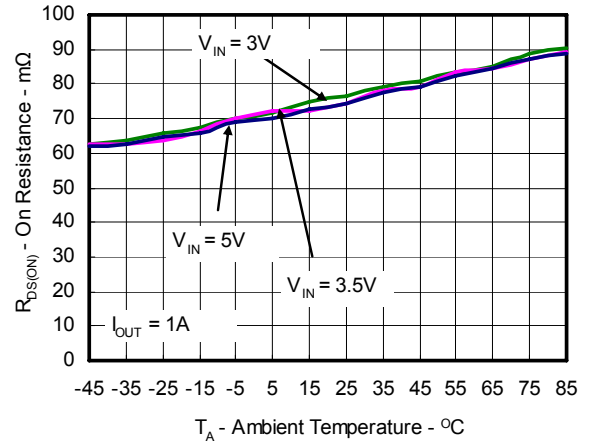

Over Current Trigger Point vs. Input Voltage

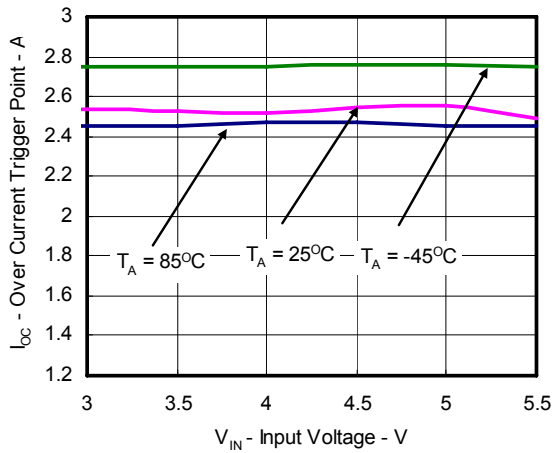

Short Circuit Current vs. Input Voltage

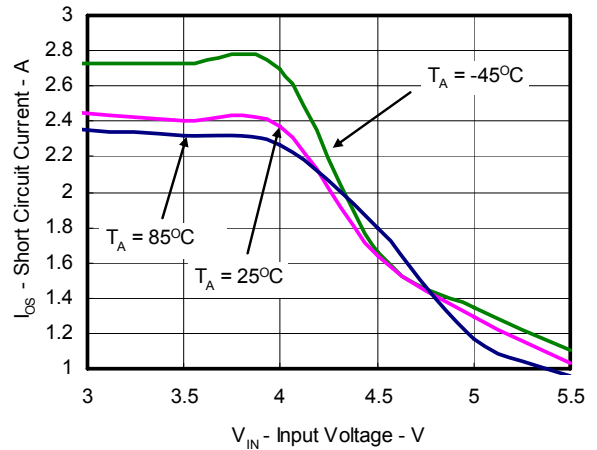

Overcurrent Protection Characteristics

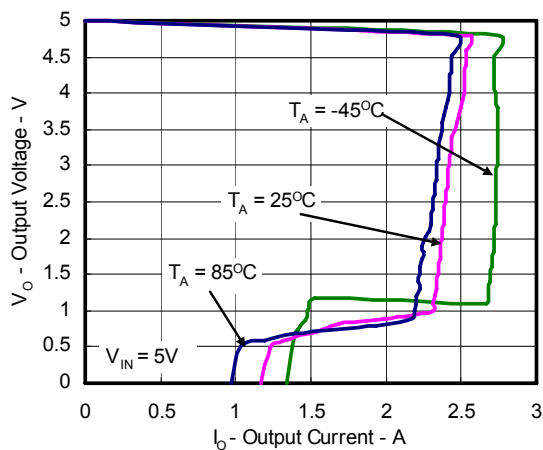

Overcurrent Protection Characteristics

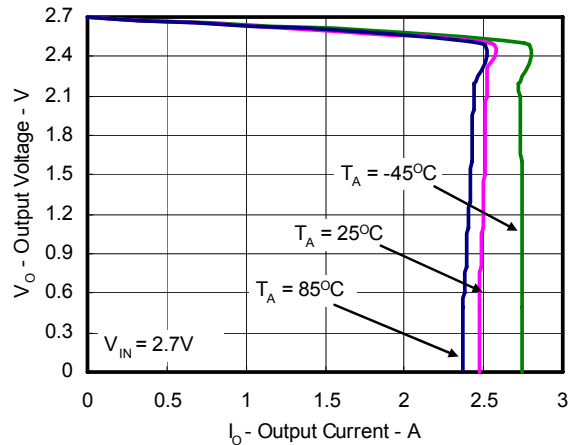

Typical Performance Characteristics (continued)

G524A Overcurrent Protection Characteristics

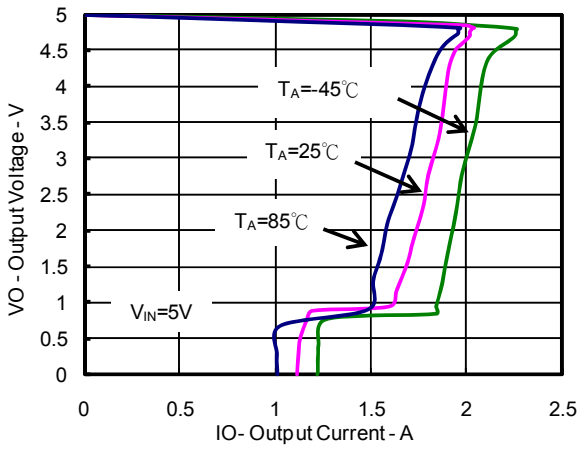

G524A Overcurrent Protection Characteristics

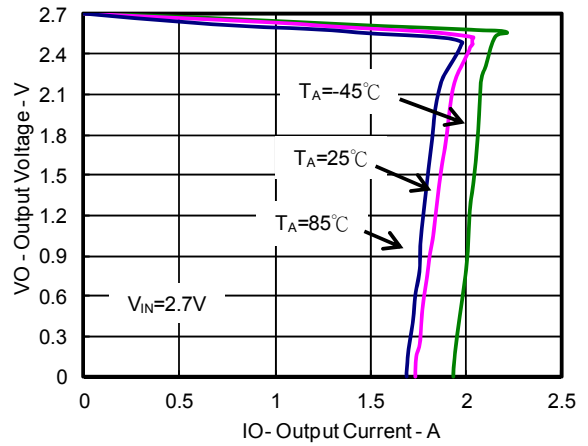

G524C Overcurrent Protection Characteristics

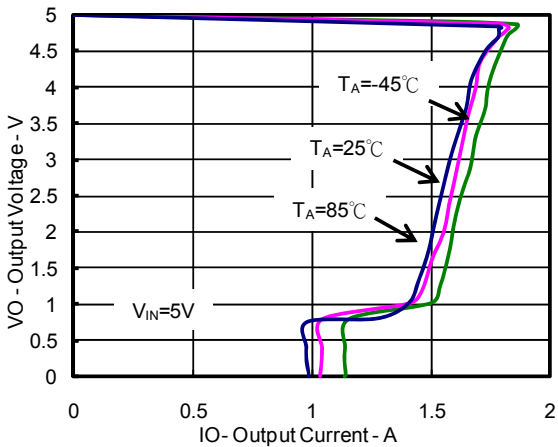

G524C Overcurrent Protection Characteristics

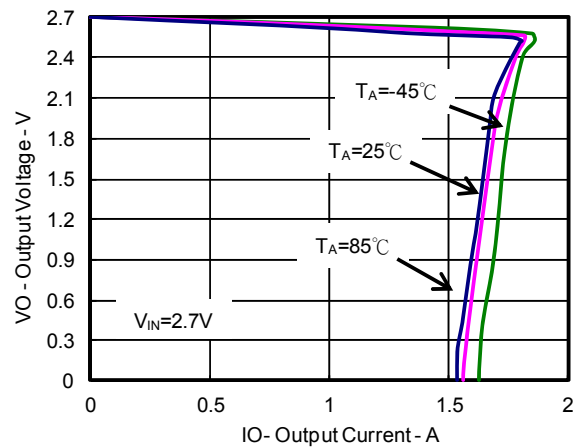

G524D Overcurrent Protection Characteristics

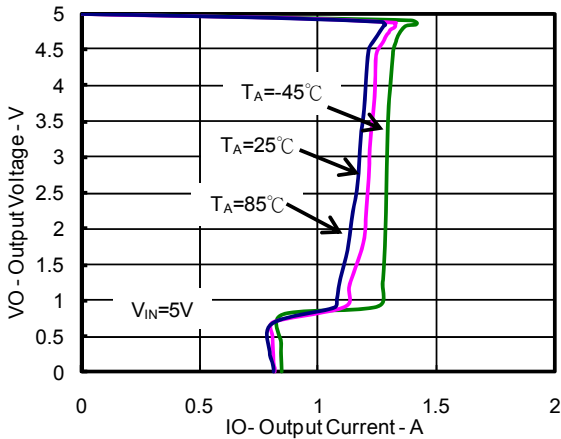

G524D Overcurrent Protection Characteristics

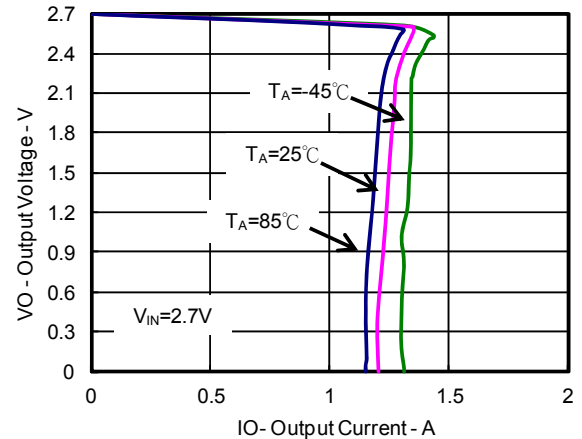

Typical Performance Characteristics (continued)

Output Reverse Current vs. Input Voltage

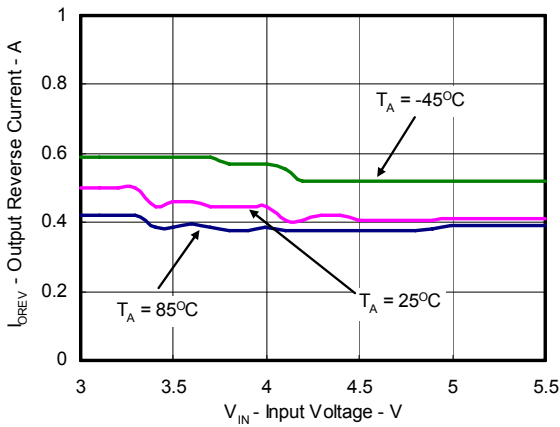

Output Reverse Current vs. Temperature

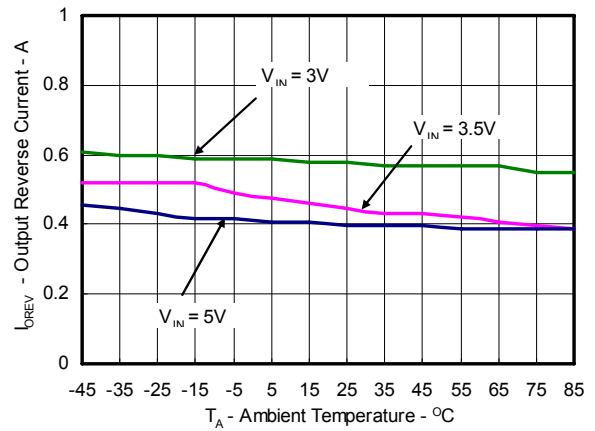

Turn on Delay Time and Rise Time

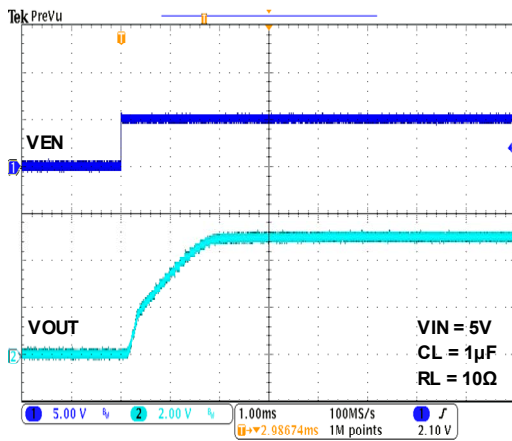

Turn off Delay Time and Fall Time

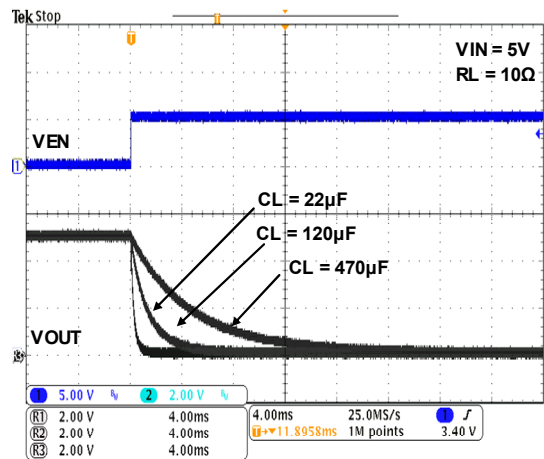

Inrush Current with Different Load Capacitance

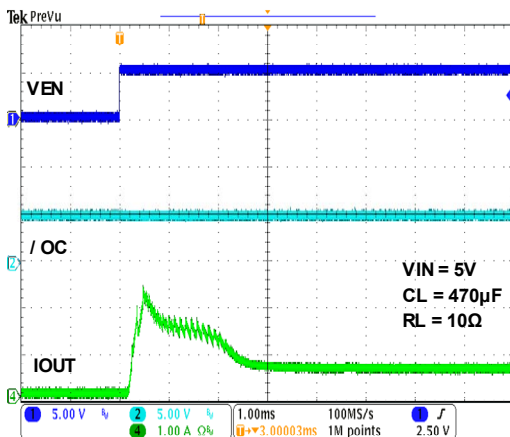

Thermal Shutdown Response

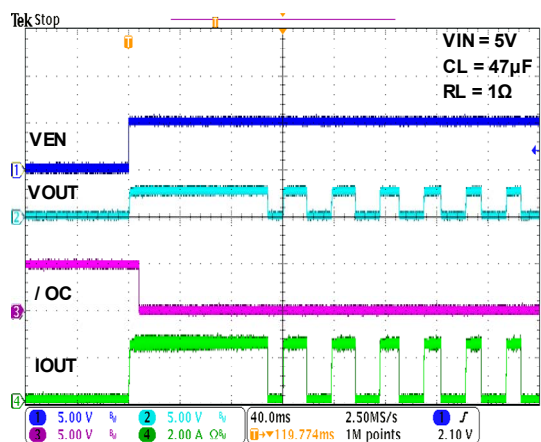

Typical Performance Characteristics (continued)

UVLO Protection at Rising

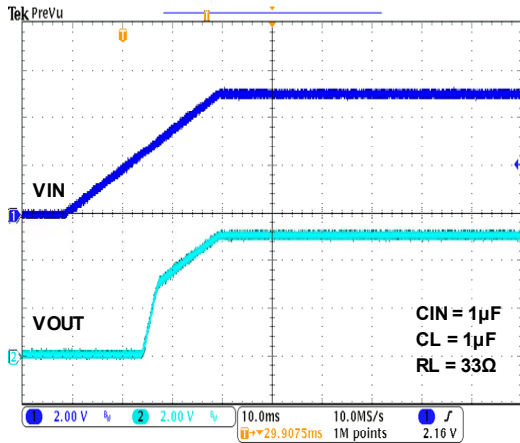

UVLO Protection at Falling

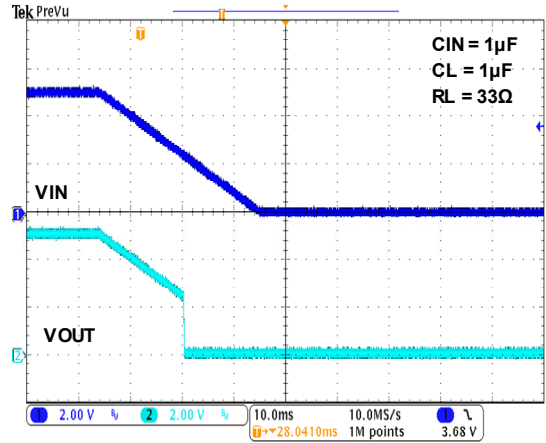

Inrush Short Circuit Response

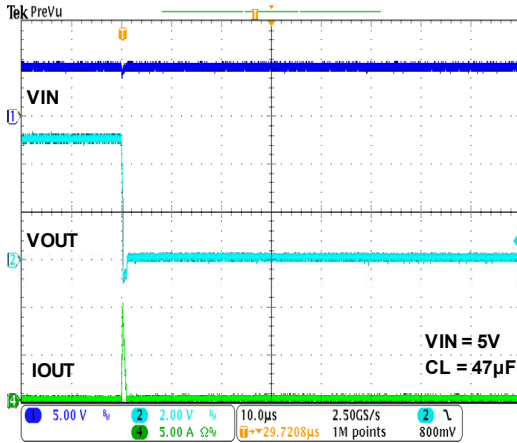

Short Circuit Response at Start up

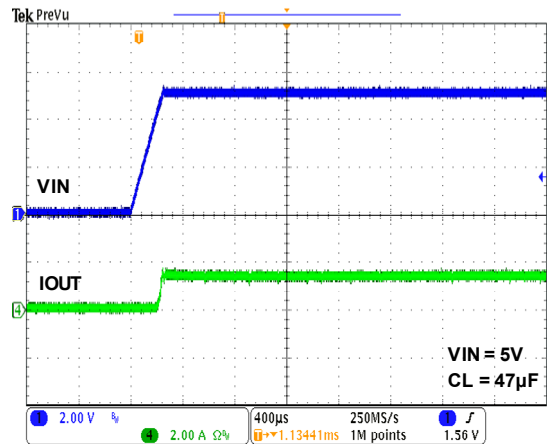

Short-Circuit Current, Device Enable into Short

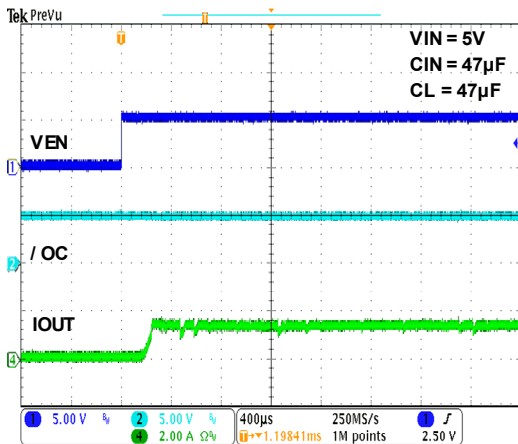

Resistance Load Inrush Response

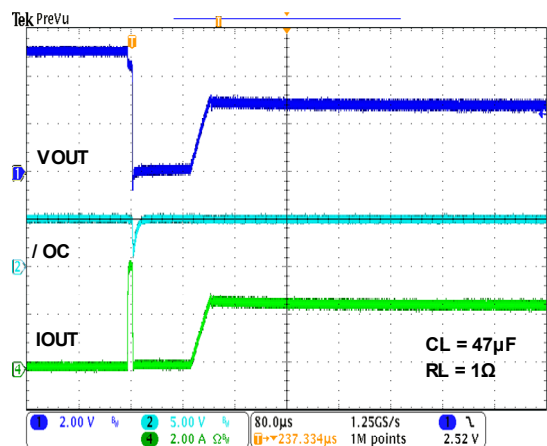

Typical Performance Characteristics (continued)

Capacitance Load Inrush Response

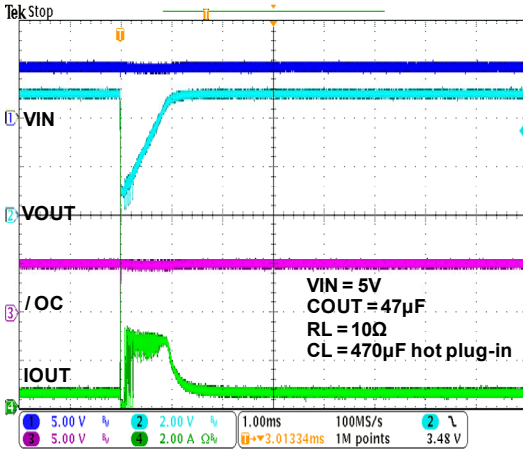

Capacitance Load Inrush Response

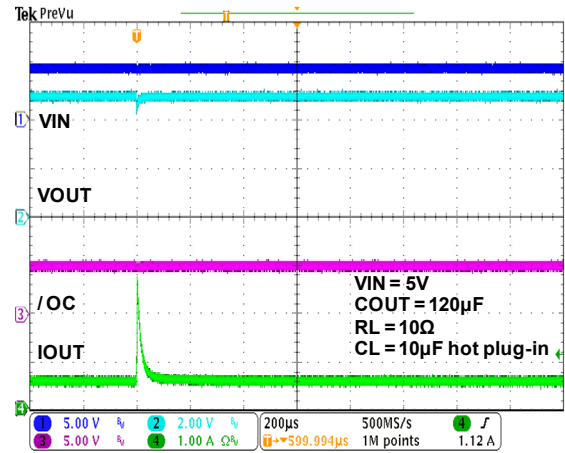

Reverse-Voltage Protection Response

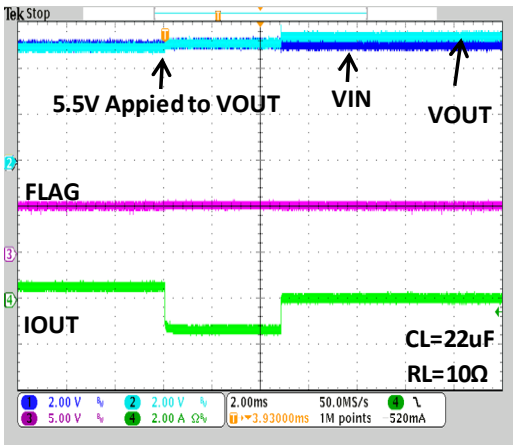

Reverse-Voltage Protection Recovery

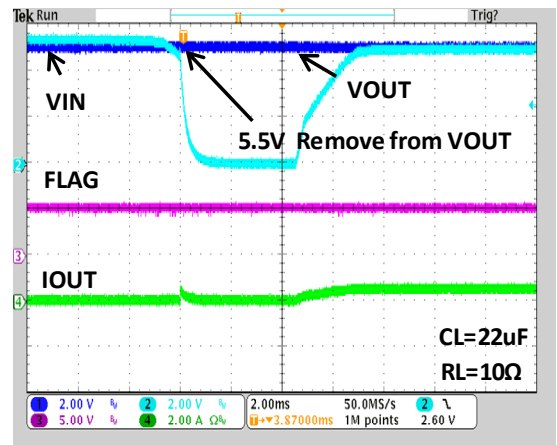

G524B3P81U

Reverse-Voltage Protection Response

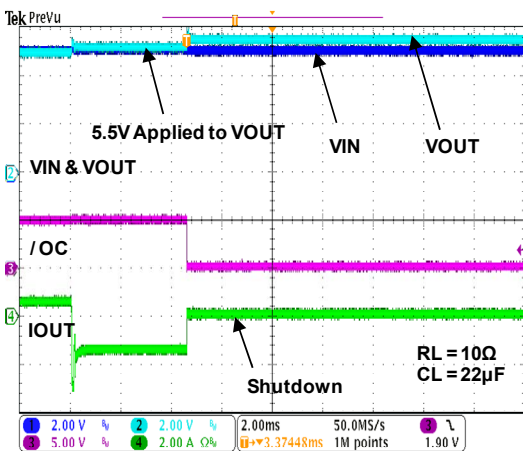

Reverse-Voltage Protection Recovery

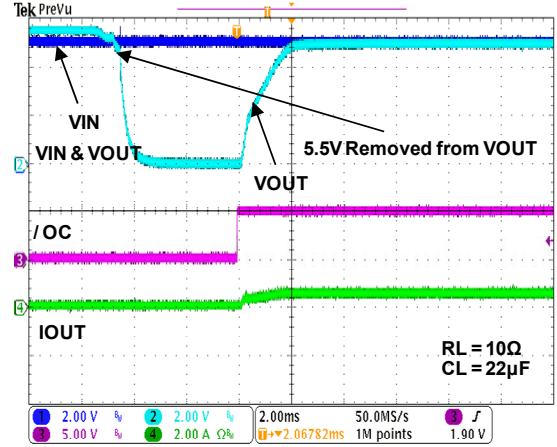

Pin Description

PIN				NAME	PIN FUNCTION
SOT-23-5	TSOT-23-6	MSOP-8	MSOP-8 (FD)		
2	2	1	1	GND	Ground
5	3	2,3	2,3	IN	Input Supply: Output MOSFET Drain, which also supplies IC's internal circuitry. Connect to positive supply.
4	1	4	4	EN($\overline{\text{EN}}$)	Enable: Logic level enable input. Make sure EN pin never floating.
3	6	5	5	$\overline{\text{OC}}$	Over-Current: Open-Drain $\overline{\text{OC}}$ output.
1	4,5	6,7,8	6,7,8	OUT	Switch Output: Output MOSFET Source of switch. Typically connect to switched side of load.
			Thermal Pad		Recommend connecting the Thermal Pad to the GND for excellent power dissipation.

Block Diagram

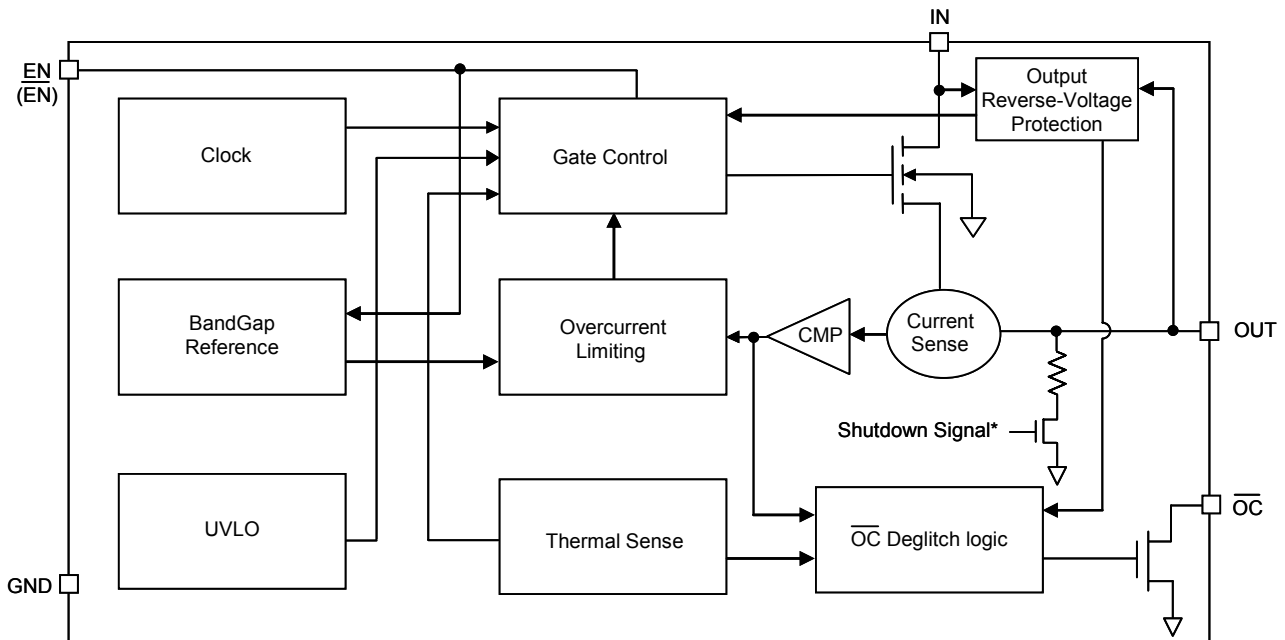

*Output Shutdown Pull-low Resistor is available in G524X1 and G524X2, X=A, B, C, and D.

Functional Description

Input and Output

IN (input) is the power supply connection to the logic circuitry and the drain of the output MOSFET. OUT (output) is the source of the output MOSFET. In a typical application, current flows through the switch from IN to OUT toward the load. Both OUT pins must be connected together to the load.

Thermal Shutdown

Thermal shutdown protects G524 from excessive power dissipation. If the die temperature exceeds 140°C, the MOSFETS switch is shut off. 20°C of hysteresis prevents the switch from turning on until the die temperature drops to 120°C. Thermal shutdown circuit functions only when the switch is enabled.

Undervoltage Lockout

UVLO (undervoltage lockout) prevents the output MOSFET from turning on until IN (input voltage) exceeds 2.4V typically. After the switch turns on, if the voltage drops below 2.4V typically, UVLO shuts off the output MOSFET.

Over Current Trigger Point

The typical over current trigger point of G524 is 2.5A, 2.1A, 2A, 1.5A. There is foldback of current limit when $V_{IN} > 3.5V$ and $V_{OUT} < 1V$. (See Typical Performance Characteristics)

Output Reverse-Voltage Protection

The output reverse-voltage protection turns off the MOSFET switch whenever the output voltage is higher than the input voltage by 20mV (typ) for 5ms (typ) and the MOSFET switch will turn on when output reverse-voltage condition is removed for 5ms (typ).

\overline{OC} Function

The \overline{OC} open-drain output is asserted (active low) when an over current condition is encountered after a 9-ms deglitch timeout. The output remains asserted until the overcurrent condition is removed. Over temperature condition is also reported immediately by \overline{OC} open-drain output. In addition, \overline{OC} (G524X3/4, X=A, B, C, D) is also asserted (active low) in output reverse-voltage condition with typical 5ms deglitch timeout period until the output reverse-voltage condition is removed.

Applications Information

Supply Filtering

A 1 μ F bypass capacitor from IN to GND, located near the G524, is strongly recommended to control supply transients. Without a bypass capacitor, an output short may cause sufficient ringing on the input (from supply lead inductance) to damage internal control circuitry.

Input transients must not exceed the absolute maximum supply voltage ($V_{IN\ max} = 6V$) even for a short duration.

EN, the Enable Input

EN must be driven logic high or logic low for a clearly defined input. Floating the input may cause unpredictable operation. EN should not be allowed to go negative with respect to GND.

Test Circuit

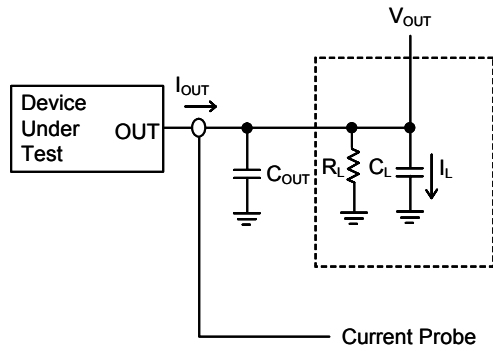

Timing Diagrams

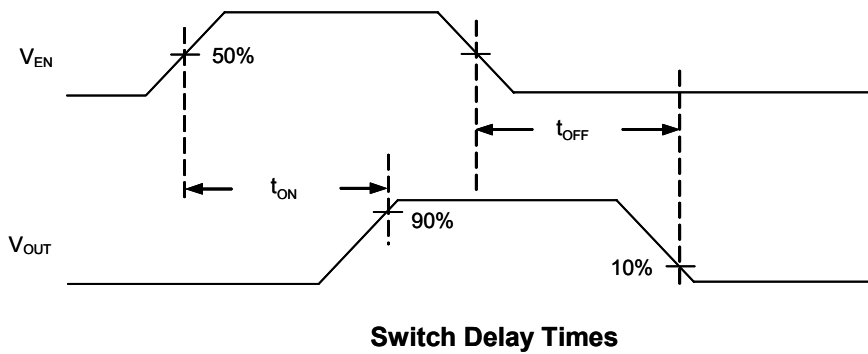
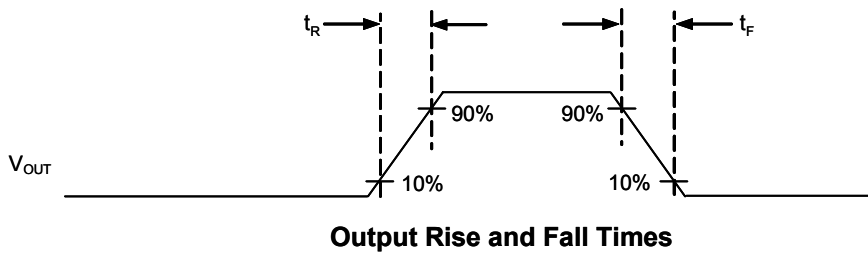

Layout Consideration

Top View

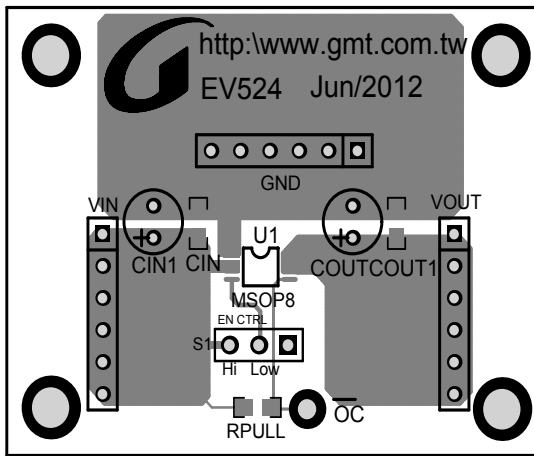

Bottom View

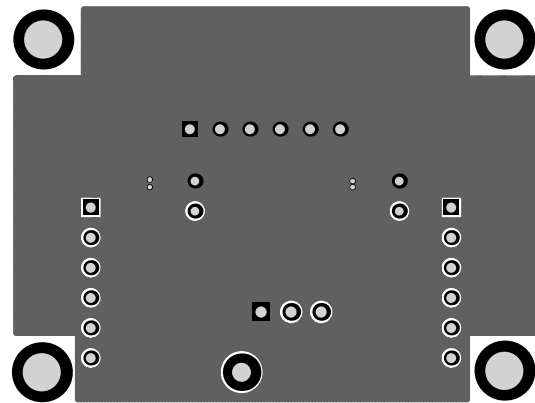

EV524 PCB	Information
Board Material	FR4
Size	46×36mm ²
Board Thickness	1.6mm
Layers	2
Copper Thickness	2 oz.

Route input and output traces as wide as possible, a whole plane is recommended
Place input capacitor as close to the G524 as possible

Package Information

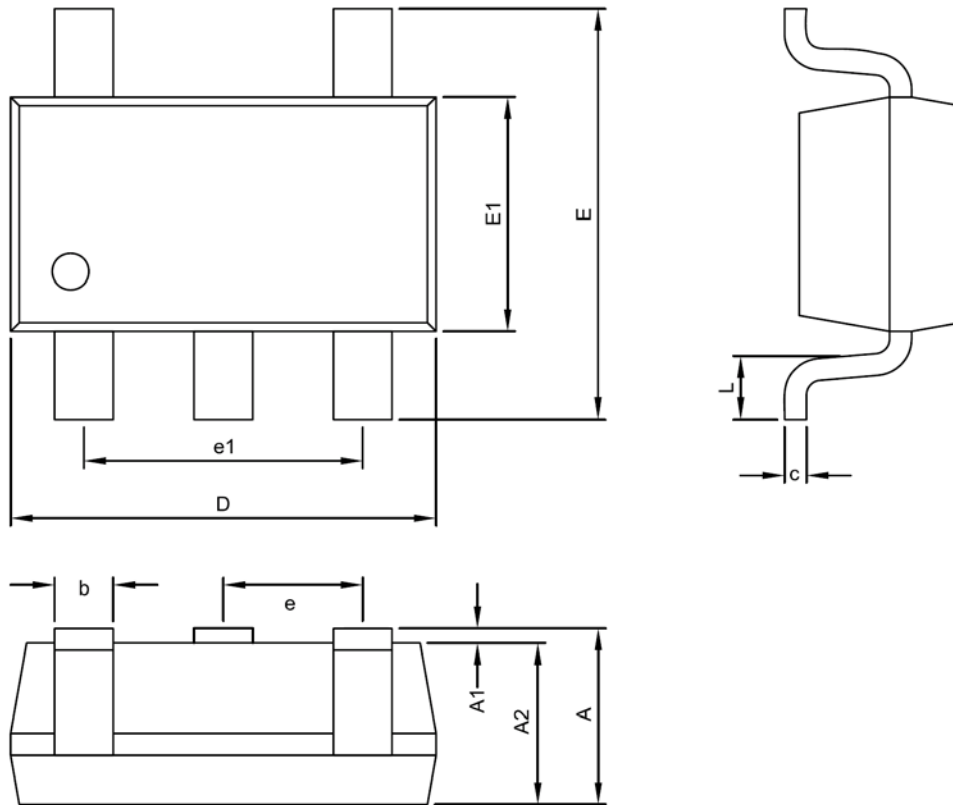

SOT-23-5 Package

Symbol	DIMENSION IN MM			DIMENSION IN INCH		
	MIN.	NOM.	MAX.	MIN.	NOM.	MAX.
A	0.95	1.10	1.45	0.037	0.043	0.057
A1	0.00	---	0.15	0.000	---	0.006
A2	0.90	1.10	1.30	0.035	0.043	0.051
D	2.70	2.90	3.10	0.106	0.114	0.122
E	2.60	2.80	3.00	0.102	0.110	0.118
E1	1.50	1.60	1.70	0.059	0.063	0.067
c	0.08	0.15	0.25	0.003	0.006	0.010
b	0.30	0.40	0.50	0.012	0.016	0.020
e	0.95 BSC			0.037 BSC		
e1	1.90 BSC			0.075 BSC		
L	0.30	0.45	0.60	0.012	0.018	0.024

Taping Specification

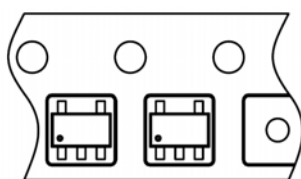

Feed Direction

PACKAGE	Q'TY/REEL
SOT-23-5	3,000 ea

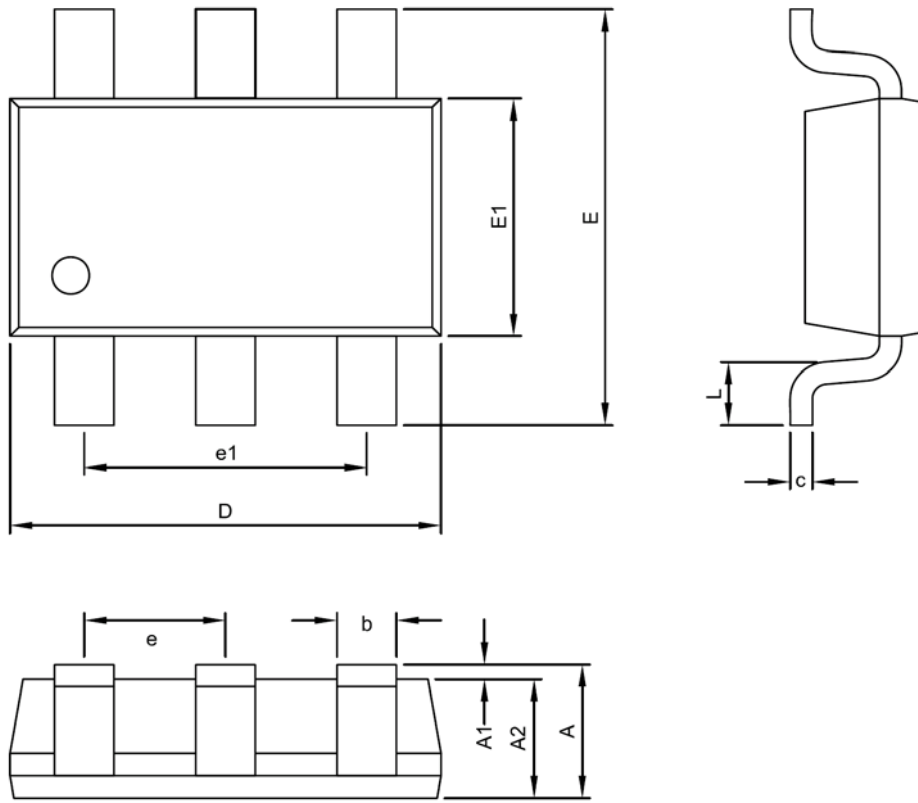

TSOT-23-6 Package

Symbol	DIMENSION IN MM			DIMENSION IN INCH		
	MIN.	NOM.	MAX.	MIN.	NOM.	MAX.
A	---	---	0.90	---	---	0.035
A1	0.00	0.05	0.10	0.000	0.002	0.004
A2	0.70	0.75	0.80	0.028	0.030	0.031
D	2.70	2.90	3.10	0.106	0.114	0.122
E	2.60	2.80	3.00	0.102	0.110	0.118
E1	1.50	1.60	1.70	0.059	0.063	0.067
c	0.08	0.15	0.25	0.003	0.006	0.010
b	0.30	0.40	0.50	0.012	0.016	0.020
e	0.95 BSC			0.037 BSC		
e1	1.90 BSC			0.075 BSC		
L	0.30	0.45	0.60	0.012	0.018	0.024

Taping Specification

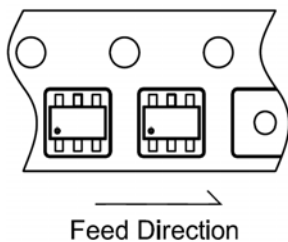

PACKAGE	Q'TY/REEL
TSOT-23-6	3,000 ea

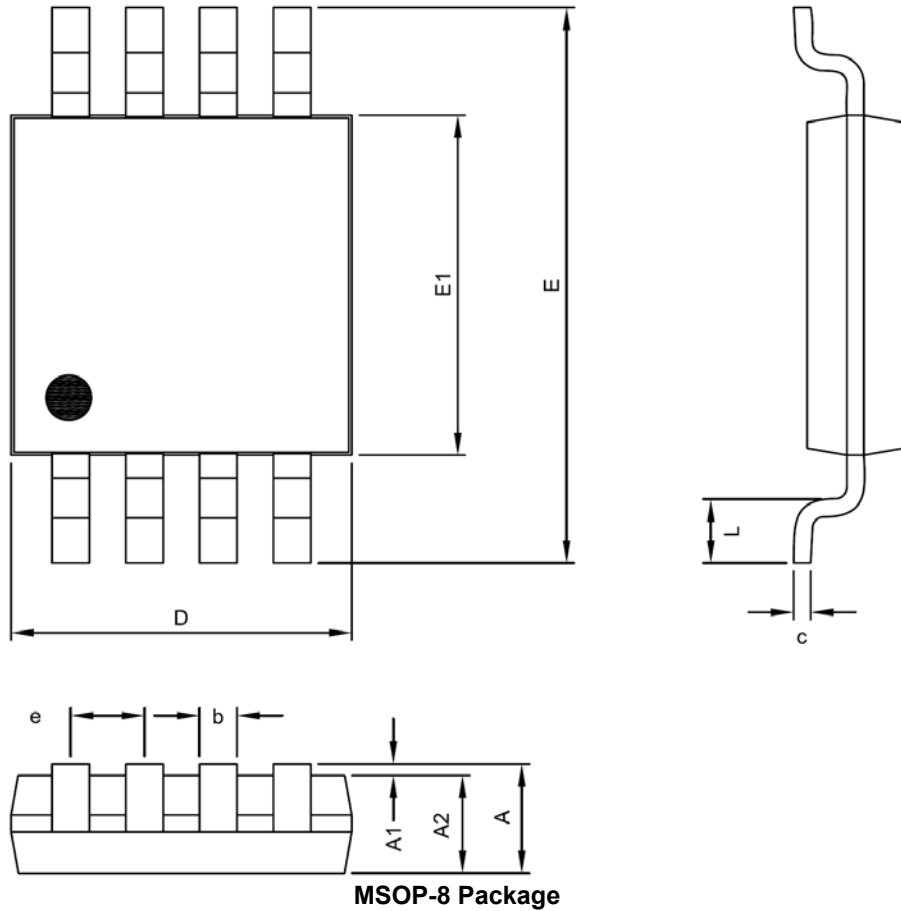

Symbol	DIMENSION IN MM			DIMENSION IN INCH		
	MIN.	NOM.	MAX.	MIN.	NOM.	MAX.
A	0.81	0.95	1.10	0.032	0.037	0.043
A1	0.00	---	0.15	0.000	---	0.006
A2	0.75	0.86	0.96	0.030	0.034	0.038
D	2.85	3.00	3.15	0.112	0.118	0.124
E	4.75	4.90	5.05	0.187	0.193	0.199
E1	2.85	3.00	3.15	0.112	0.118	0.124
b	0.22	0.30	0.38	0.009	0.012	0.015
c	0.15 REF			0.006 REF		
e	0.65 BSC			0.026 BSC		
L	0.4	0.53	0.8	0.016	0.021	0.031

Taping Specification

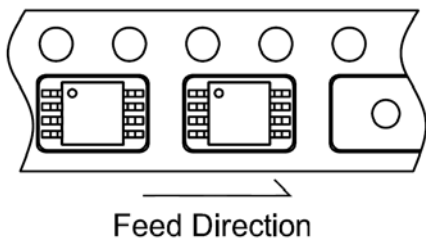

PACKAGE	Q'TY/REEL
MSOP-8	3,000 ea

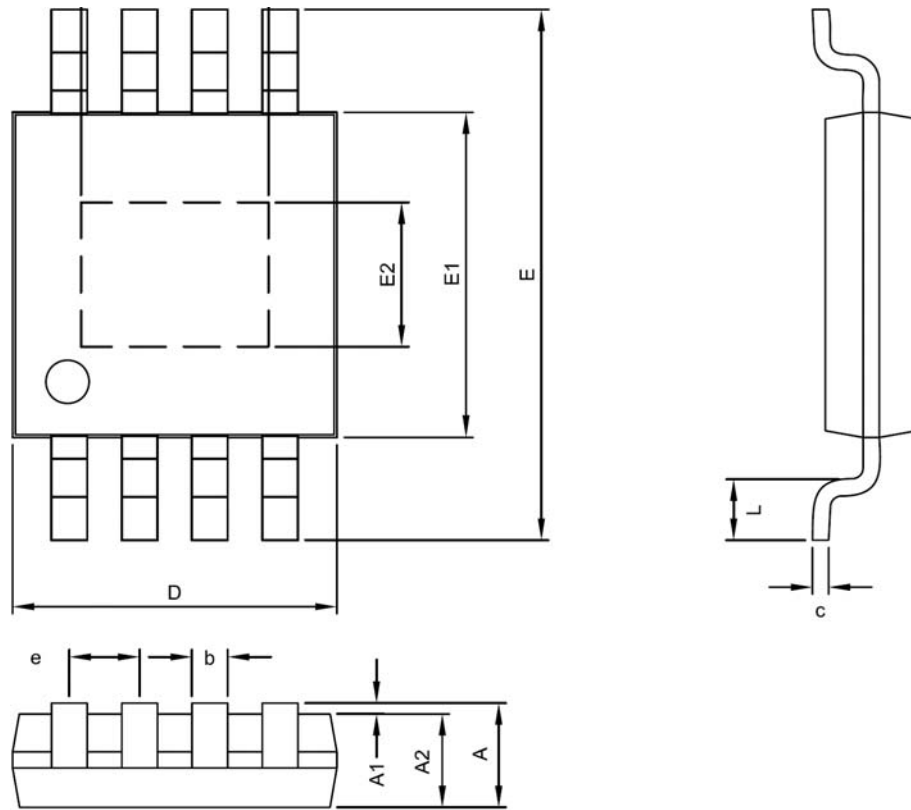
MSOP-8 (FD) Package

Symbol	DIMENSION IN MM			DIMENSION IN INCH		
	MIN.	NOM.	MAX.	MIN.	NOM.	MAX.
A	0.81	0.95	1.10	0.032	0.037	0.043
A1	0.00	---	0.15	0.000	---	0.006
A2	0.75	0.86	0.96	0.030	0.034	0.038
D	2.85	3.00	3.15	0.112	0.118	0.124
D1	1.40	1.90	2.10	0.055	0.074	0.083
E	4.75	4.90	5.05	0.187	0.193	0.199
E1	2.85	3.00	3.15	0.112	0.118	0.124
E2	1.35	1.60	1.75	0.053	0.063	0.069
b	0.22	0.30	0.38	0.009	0.012	0.015
c	0.15 REF			0.006 REF		
e	0.65 BSC			0.026 BSC		
L	0.4	0.53	0.8	0.016	0.021	0.031

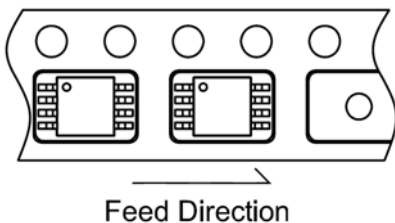
Taping Specification

PACKAGE	Q'TY/REEL
MSOP-8 (FD)	3,000 ea

GMT Inc. does not assume any responsibility for use of any circuitry described, no circuit patent licenses are implied and GMT Inc. reserves the right at any time without notice to change said circuitry and specifications.