

10.2 A01 715G5246 PSU 42" 3500/4000 series
10-2-1 Power Circuit

A01

Power Circuit

A01

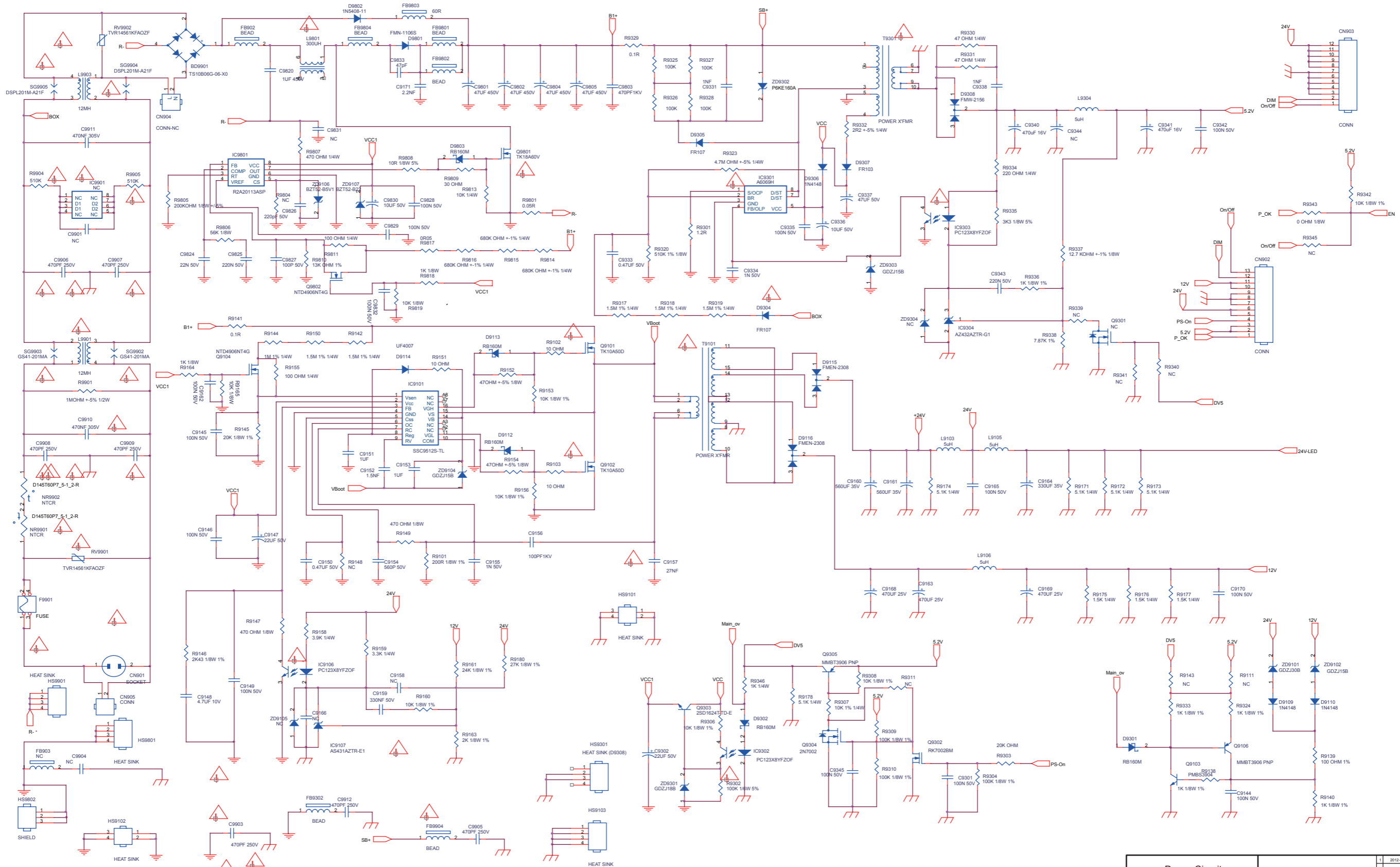

Power Circuit	715G5246	1	2012-01-10

10-2-2 24 V to VLED

A02

24 V to VLED

A02

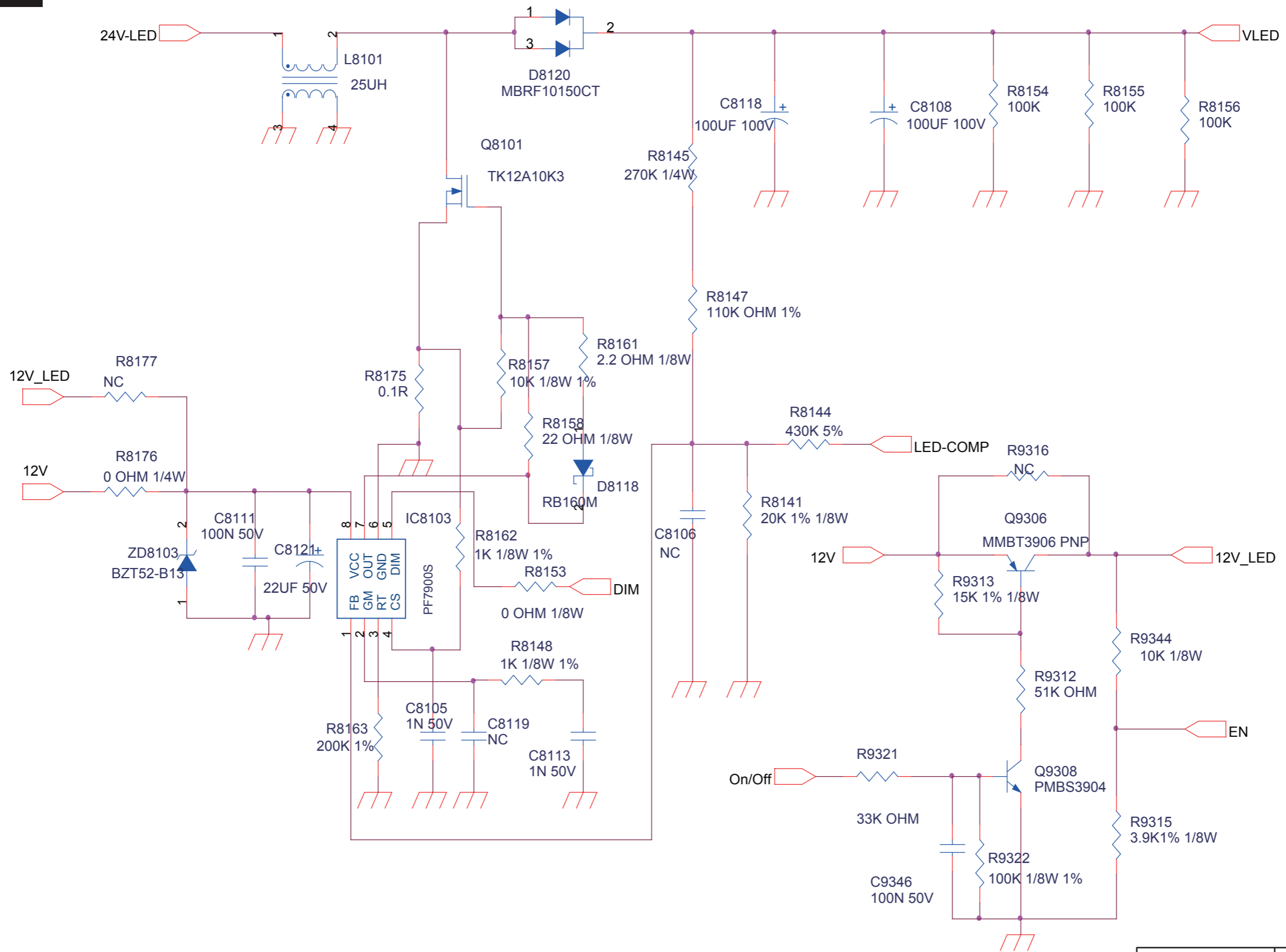

24 V to VLED	715G5246	1	2012-01-18

A03

LED Driver

A03

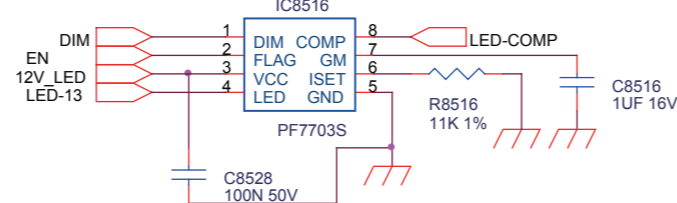
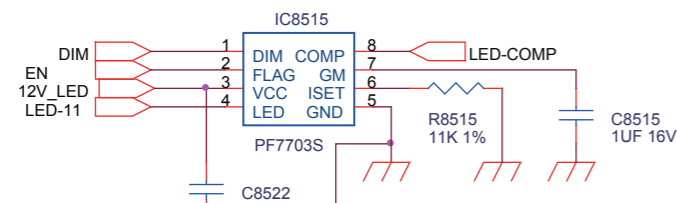
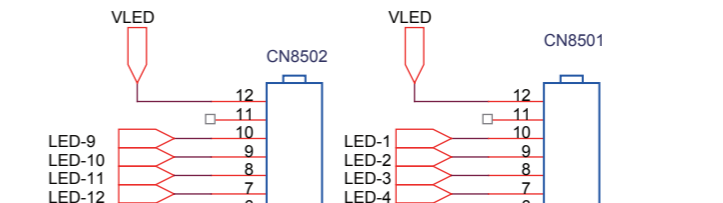
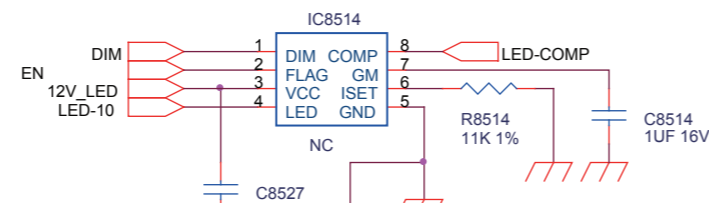
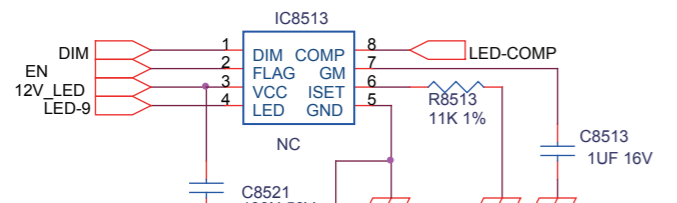
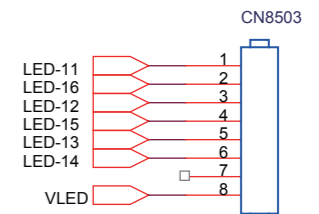
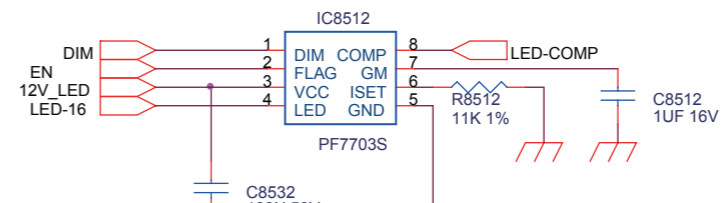
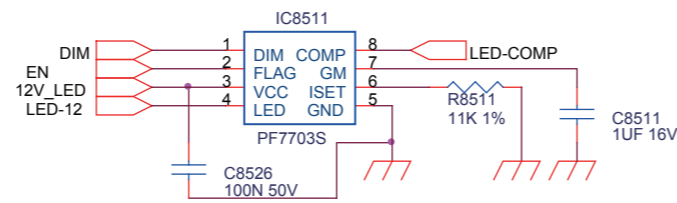
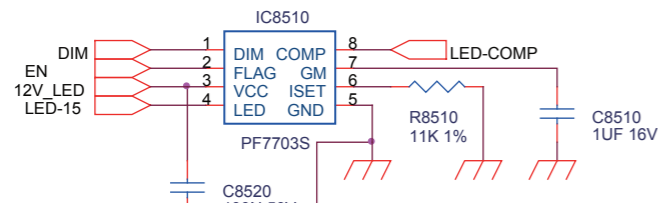
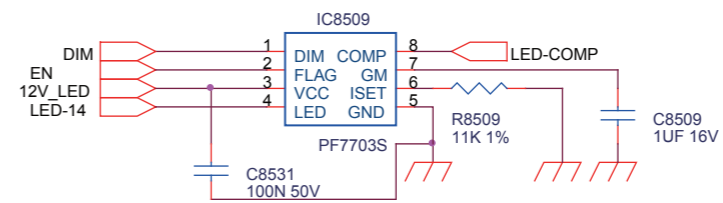
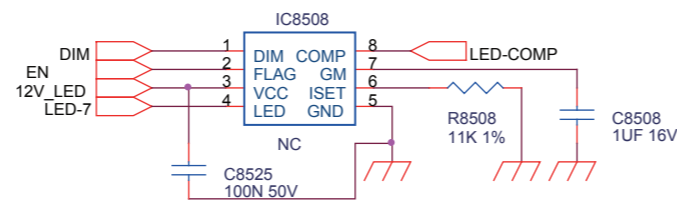
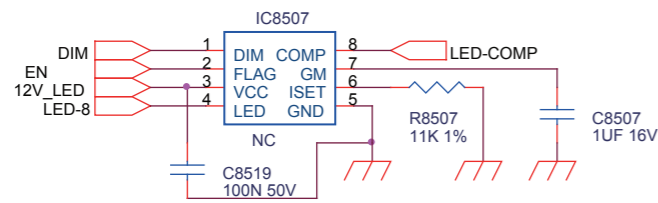
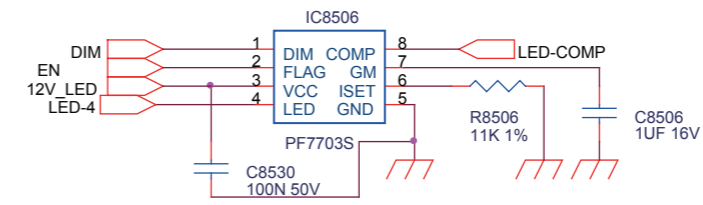
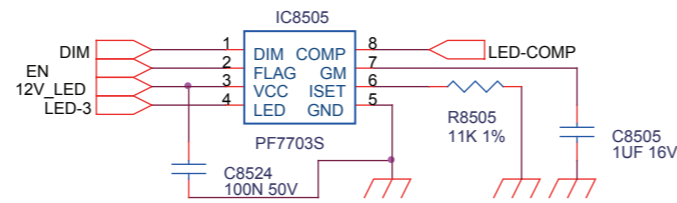
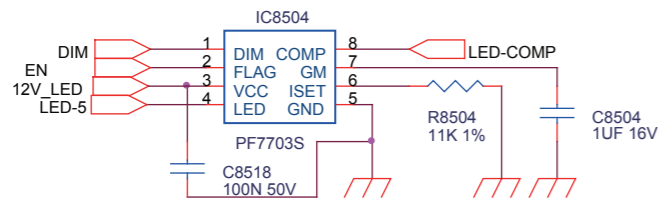
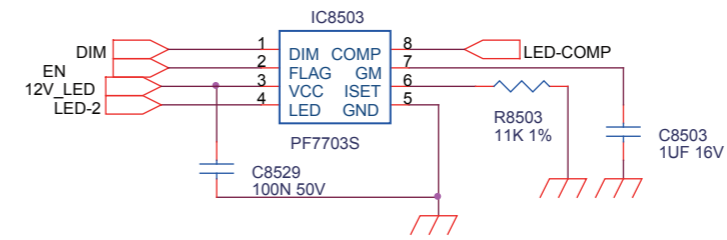
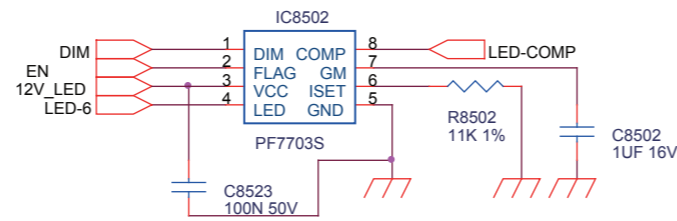
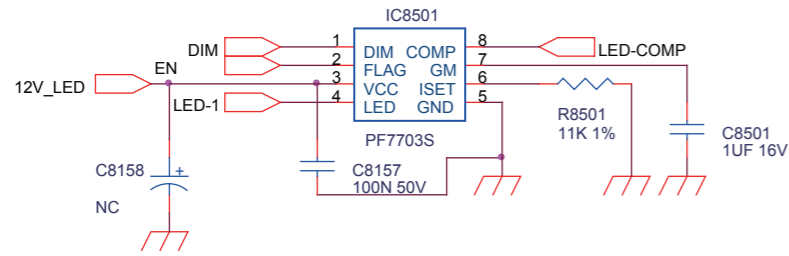

LED Driver	715G5246	1	2012-01-10

10-2-4 Power layout top

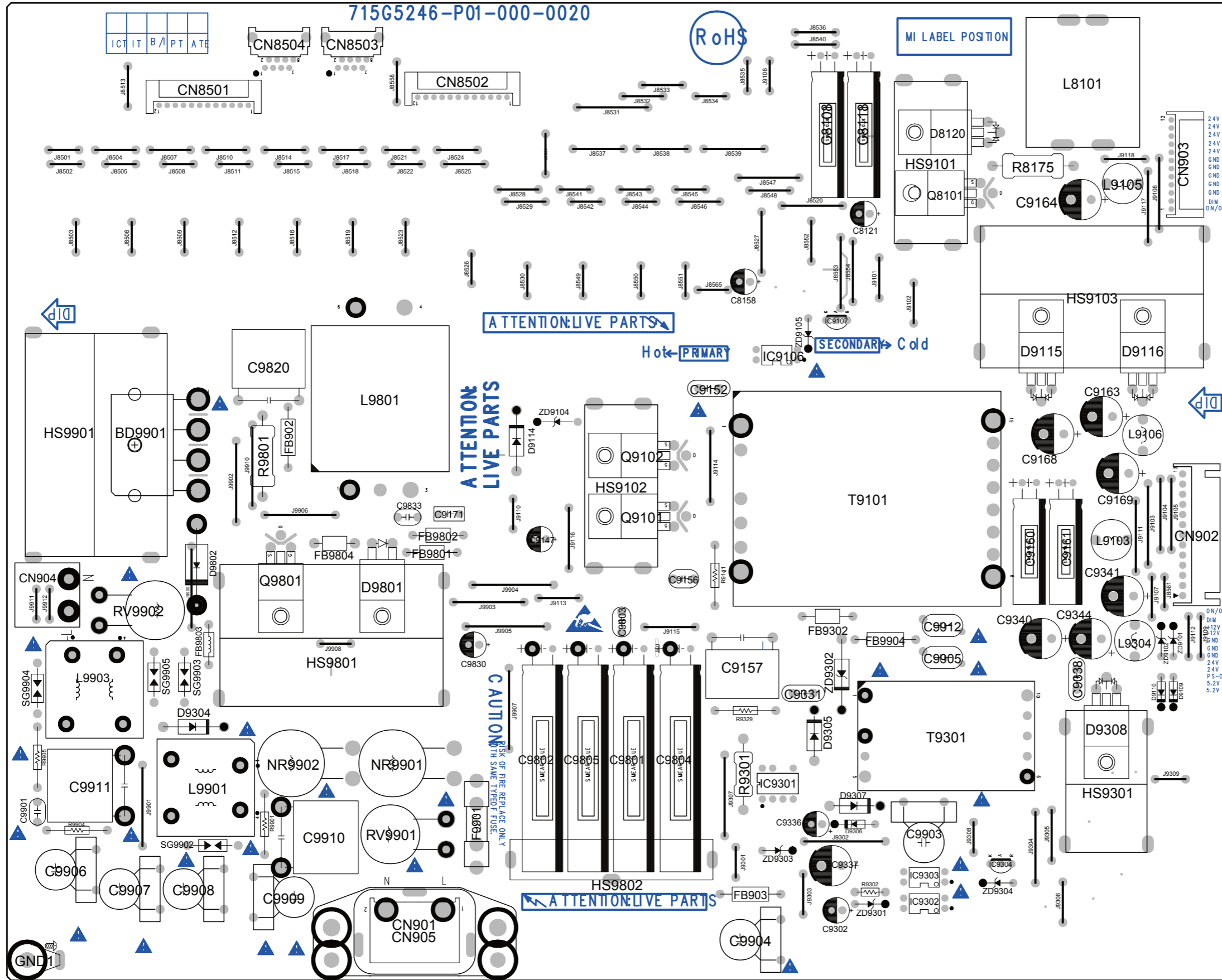

Power layout top	715G5246	1	2011.12.22

10-2-5 Power layout bottom

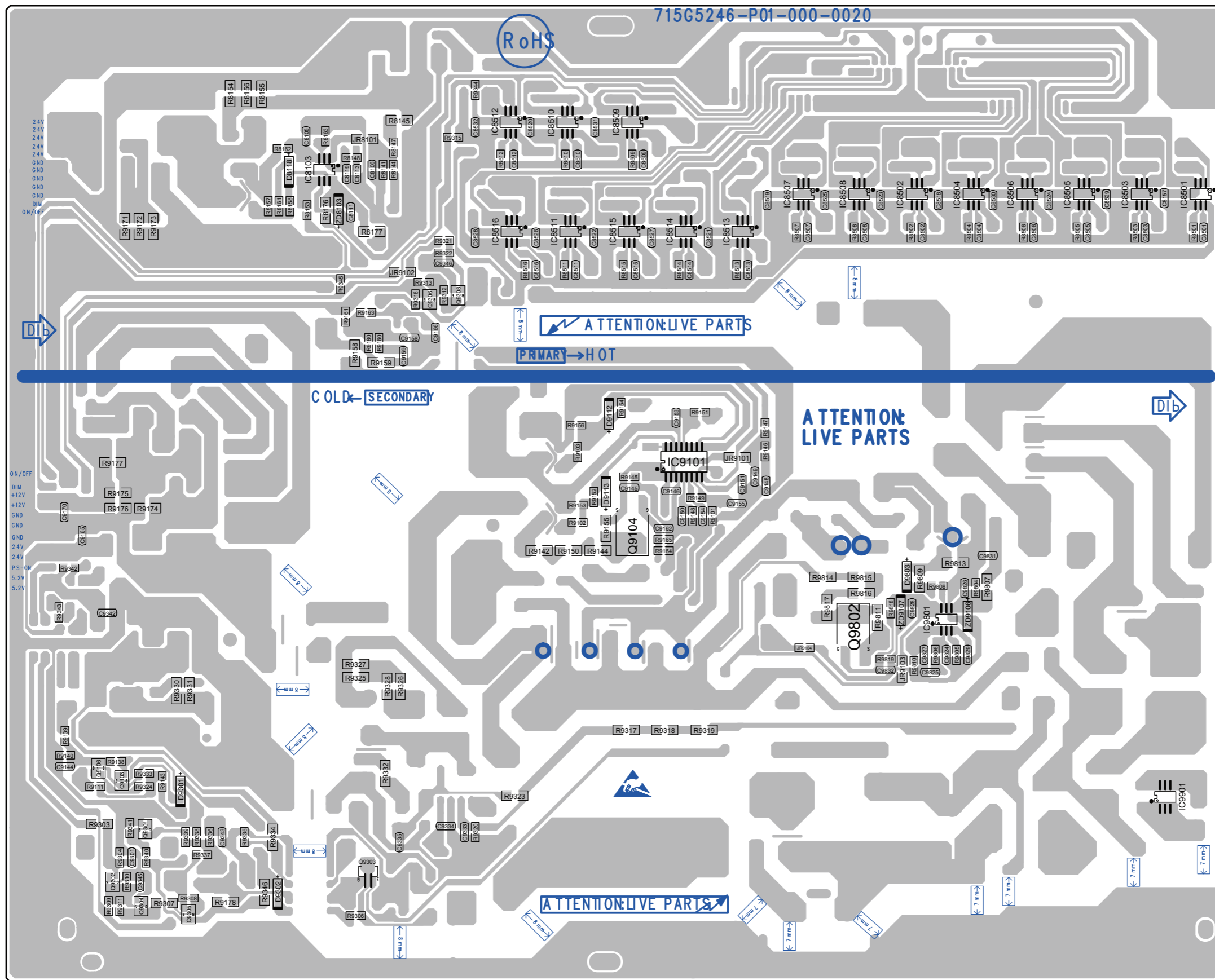

Power layout bottom	715G5246	1	2011.12.22