

JVC

SERVICE MANUAL

COLOUR TELEVISION

BASIC CHASSIS

CH

AV-29LS2 AV-29LX2 /A AV-29LX2 AV-2968TEE



RM-C1020-1H
[AV-29LS2]



RM-C1024-1H
[AV-29LX2]
[AV-29LX2/A]



RM-C1023-1H
[AV-2968TEE]

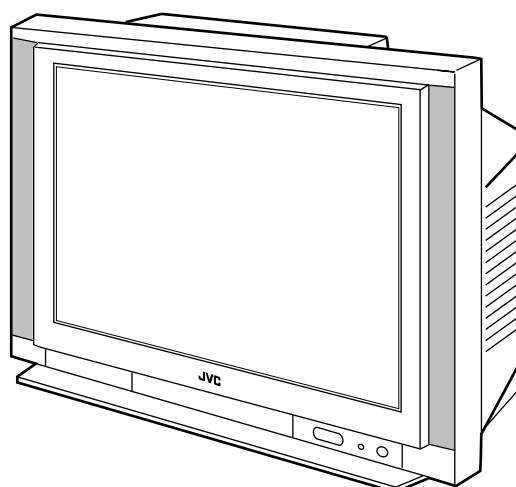

CONTENTS

■ SPECIFICATIONS	2
■ OPERATING INSTRUCTIONS (APPENDIX)	
■ SAFETY PRECAUTIONS	3
■ FEATURES	4
■ FUNCTIONS	5
■ SPECIFIC SERVICE INSTRUCTIONS	6
■ SERVICE ADJUSTMENTS	14
■ STANDARD CIRCUIT DIAGRAM (APPENDIX)	2-1
■ PARTS LIST	41

AV-29LS2 AV-29LX2 AV-29LX2 /A AV-2968TEE STANDARD CIRCUIT DIAGRAM

■ NOTE ON USING CIRCUIT DIAGRAMS

1. SAFETY

The components identified by the \triangle symbol and shading are critical for safety. For continued safety replace safety critical components only with manufactures recommended parts.

2. SPECIFIED VOLTAGE AND WAVEFORM VALUES

The voltage and waveform values have been measured under the following conditions.

- (1) Input signal : Colour bar signal
- (2) Setting positions of each knob/button and variable resistor : Original setting position when shipped
- (3) Internal resistance of tester : DC 20k Ω /V
- (4) Oscilloscope sweeping time : H \Rightarrow 20 μ S/div
: V \Rightarrow 5mS/div
: Others \Rightarrow Sweeping time is specified
- (5) Voltage values : All DC voltage values

*Since the voltage values of signal circuit vary to some extent according to adjustments, use them as reference values.

3. INDICATION OF PARTS SYMBOL [EXAMPLE]

- In the PW board : R1209 \rightarrow R209

4. INDICATIONS ON THE CIRCUIT DIAGRAM

(1) Resistors

• Resistance value

- No unit : [Ω]
- k : [k Ω]
- M : [M Ω]

• Rated allowable power

- No indication : 1/16 [W]
- Others : As specified

• Type

- No indication : Carbon resistor
- OMR : Oxide metal film resistor
- MFR : Metal film resistor
- MPR : Metal plate resistor
- UNFR : Uninflammable resistor
- FR : Fusible resistor

*Composition resistor 1/2 [W] is specified as 1/2S or Comp.

(2) Capacitors

• Capacitance value

- 1 or higher : [pF]
- less than 1 : [μ F]

• Withstand voltage

- No indication : DC50[V]
- AC indicated : AC withstand voltage [V]
- Others : DC withstand voltage [V]

* Electrolytic Capacitors

47/50[Example] : Capacitance value [μ F]/withstand voltage[V]





• Type

- No indication : Ceramic capacitor
- MY : Mylar capacitor
- MM : Metalized mylar capacitor
- PP : Polypropylene capacitor
- MPP : Metalized polypropylene capacitor
- MF : Metalized film capacitor
- TF : Thin film capacitor
- BP : Bipolar electrolytic capacitor
- TAN : Tantalum capacitor

(3) Coils



- No unit : [μ H]
- Others : As specified

(4) Power Supply



-  : B1
-  : B2(12V)
-  : 9V
-  : 5V

*Respective voltage values are indicated



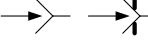

(5) Test point

-  : Test point
-  : Only test point display

(6) Connecting method

-  : Connector
-  : Wrapping or soldering
-  : Receptacle

(7) Ground symbol

-  : LIVE side ground
-  : ISOLATED(NEUTRAL) side ground
-  : EARTH ground
-  : DIGITAL ground

5. NOTE FOR REPAIRING SERVICE

This model's power circuit is partly different in the GND. The difference of the GND is shown by the LIVE : (\perp) side GND and the ISOLATED(NEUTRAL) : (---) side GND. Therefore, care must be taken for the following points.

- (1) Do not touch the LIVE side GND or the LIVE side GND and the ISOLATED(NEUTRAL) side GND simultaneously. If the above caution is not respected, an electric shock may be caused. Therefore, make sure that the power cord is surely removed from the receptacle when, for example, the chassis is pulled out.
- (2) Do not short between the LIVE side GND and ISOLATED(NEUTRAL) side GND or never measure the LIVE side GND and ISOLATED(NEUTRAL) side GND at the same time with a measuring apparatus (oscilloscope, etc.). If the above precaution is not respected , a fuse or any parts will be broken.

• Since the circuit diagram is a standard one, the circuit and circuit constants may be subject to change for improvement without any notice.

CONTENTS

SEMICONDUCTOR SHAPES 2-2

BLOCK DIAGRAM 2-3

CIRCUIT DIAGRAMS

MAIN PWB CIRCUIT DIAGRAM (1/2) [AV-29LS2] 2-5

MAIN PWB CIRCUIT DIAGRAM (2/2) [AV-29LS2] 2-7

MAIN PWB CIRCUIT DIAGRAM (1/2) [AV-29LX2, AV-29LX2/A, AV-2968TEE] 2-9

MAIN PWB CIRCUIT DIAGRAM (2/2) [AV-29LX2, AV-29LX2/A, AV-2968TEE] 2-11

CRT SOCKET PWB CIRCUIT DIAGRAM 2-13

FRONT CONTROL PWB CIRCUIT DIAGRAM 2-15

PATTERN DIAGRAMS

MAIN PWB PATTERN 2-17

CRT SOCKET PWB PATTERN 2-19

FRONT CONTROL PWB PATTERN 2-20

SEMICONDUCTOR SHAPES

TRANSISTOR

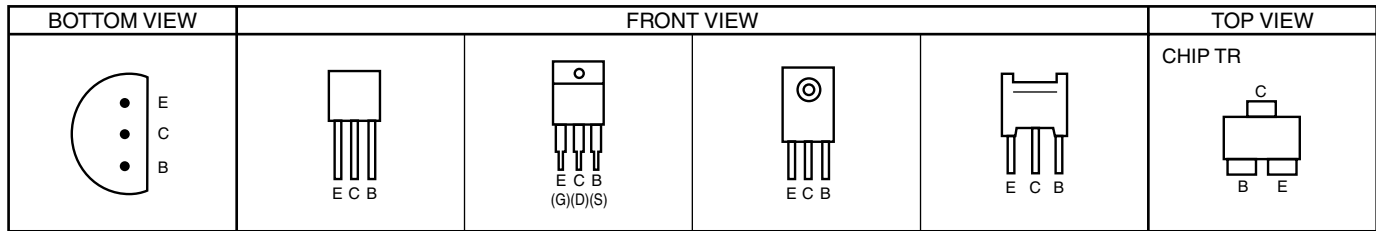

IC

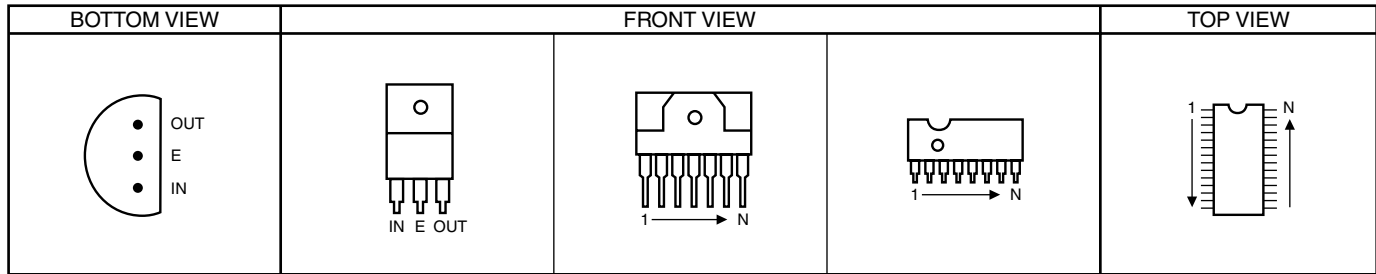

CHIP IC

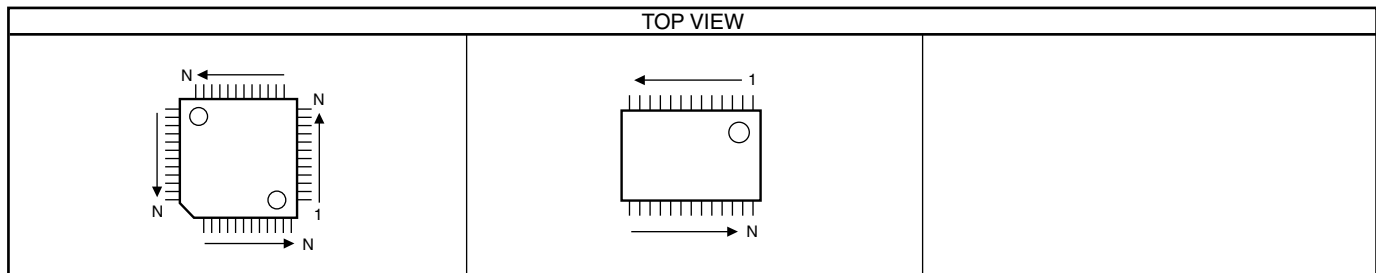

BLOCK DIAGRAM

AV-29LS2
AV-29LX2
AV-2968TEE

AV-29LS2
AV-29LX2
AV-2968TEE

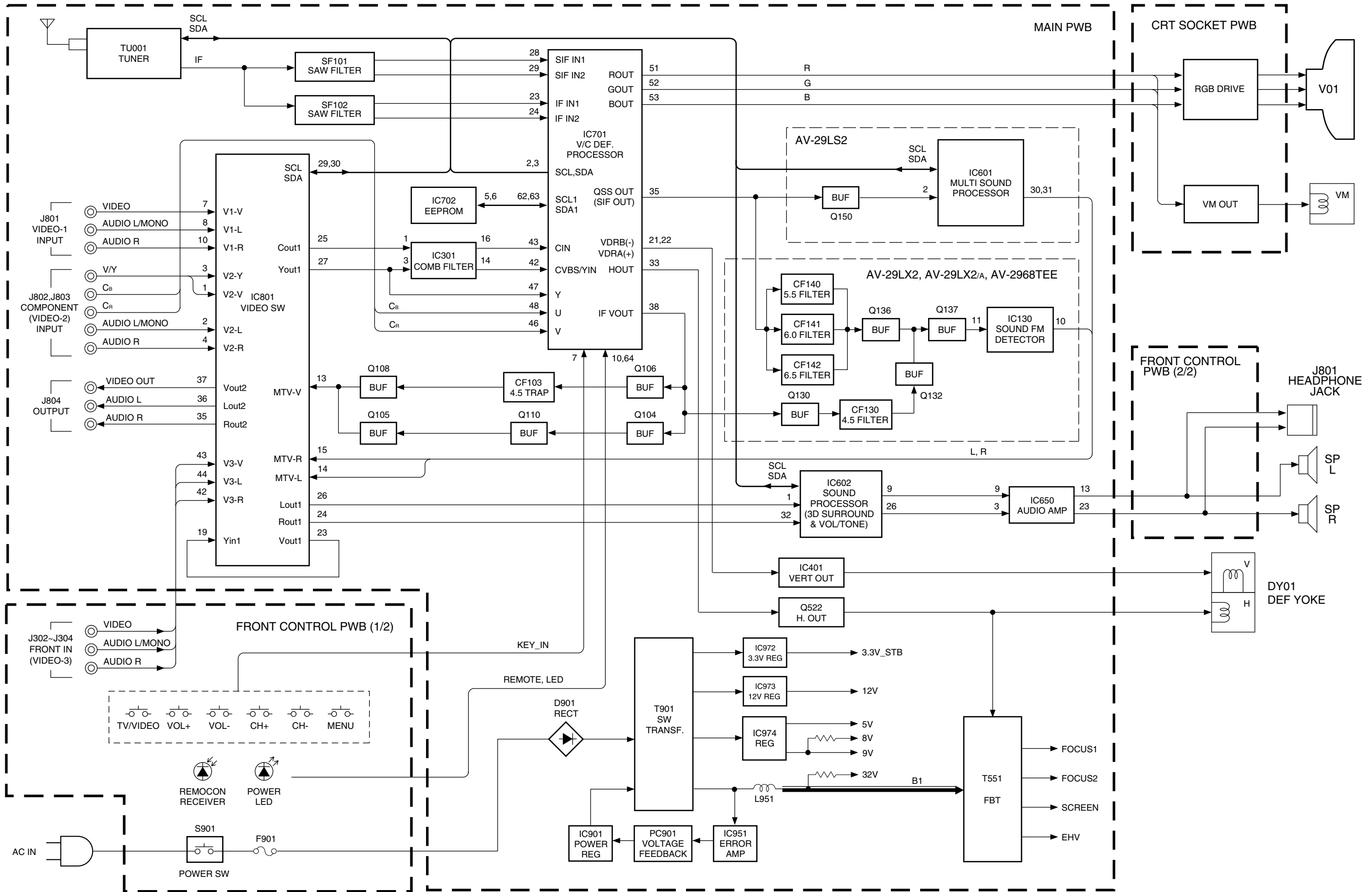

CIRCUIT DIAGRAMS

MAIN PWB CIRCUIT DIAGRAM (1/2) [AV-29LS2]

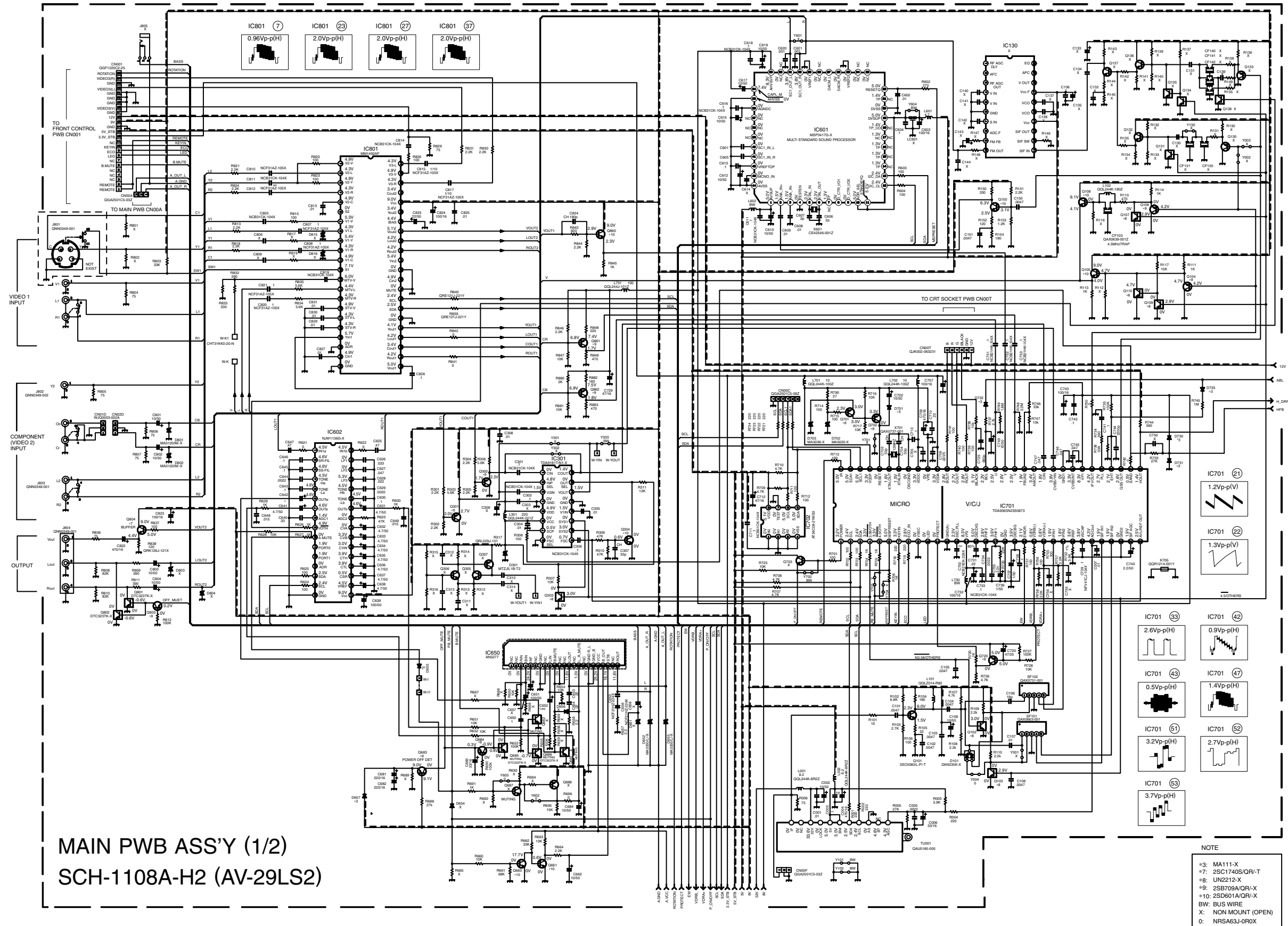

MAIN PWB ASS'Y (1/2)
SCH-1108A-H2 (AV-29LS2)

NOTE

- *3: MA111-X
- *7: 2SC1740S/QR/T
- *8: UN2212-X
- *9: 2SB709A/QR/-X
- *10: 2SD601A/QR/-X
- BW: BUS WIRE
- X: NON MOUNT (OPEN)
- 0: NRS6A3J-0R0X

MAIN PWB CIRCUIT DIAGRAM (2/2) [AV-29LS2]

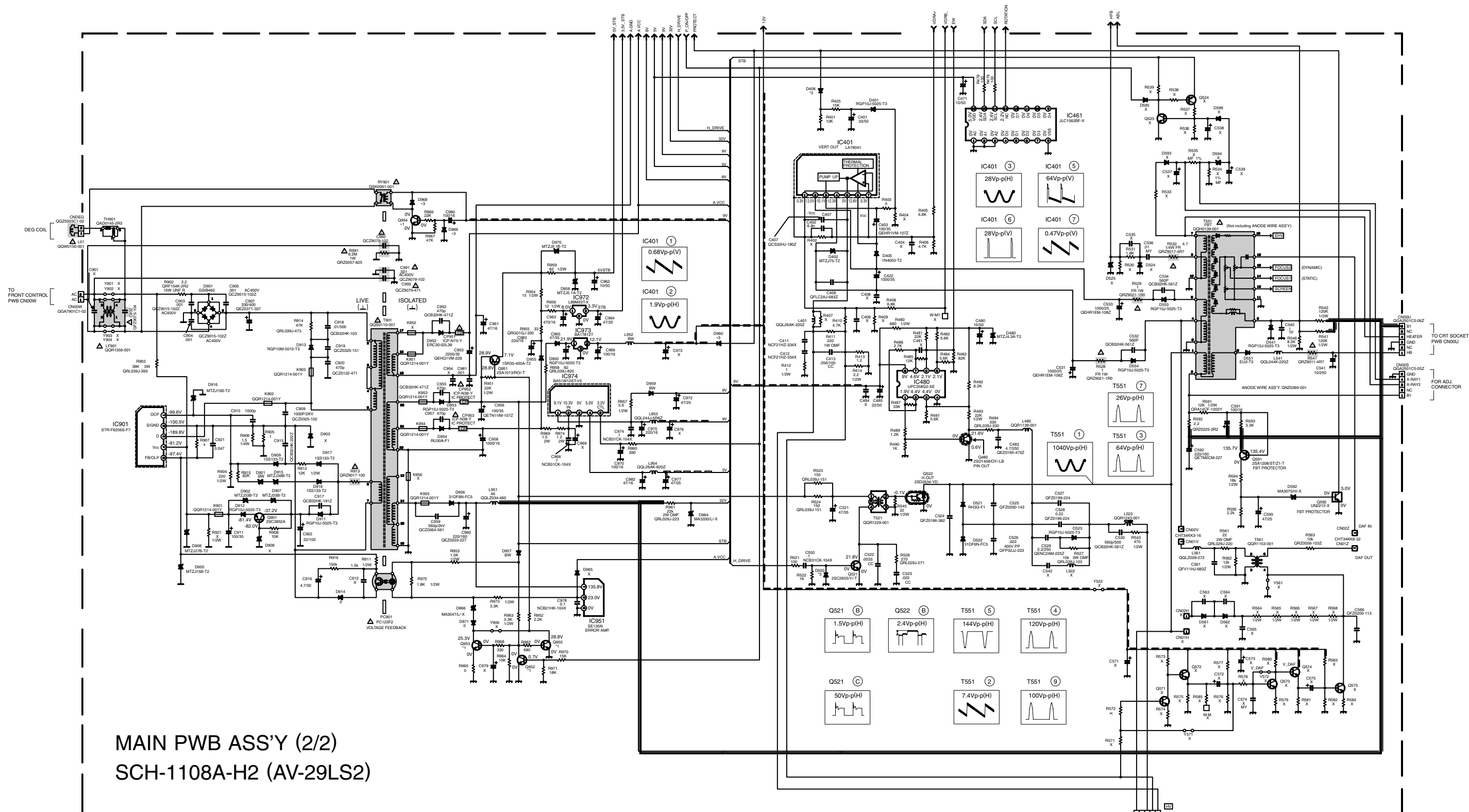

MAIN PWB ASS'Y (2/2)
SCH-1108A-H2 (AV-29LS2)

NOTE

- *1: 2SC2412K/QR-X
- *3: MA111-X
- BW: BUS WIRE
- X: NON MOUNT (OPEN)
- 0: NRSAB3J-OROX

MAIN PWB CIRCUIT DIAGRAM (1/2) [AV-29LX2, AV-29LX2/A, AV2968TEE]

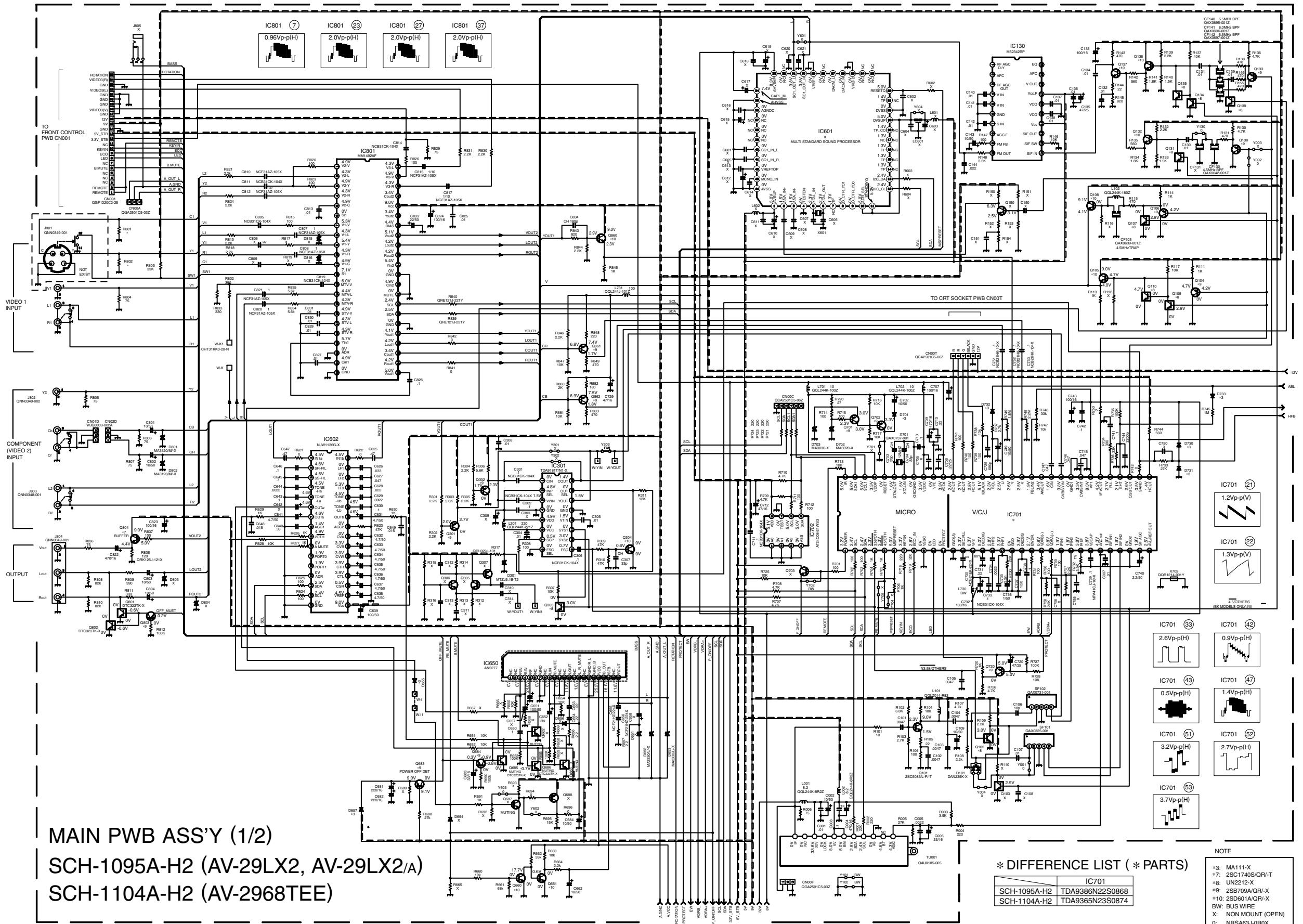

MAIN PWB ASS'Y (1/2)
SCH-1095A-H2 (AV-29LX2, AV-29LX2/A)
SCH-1104A-H2 (AV-2968TEE)

MAIN PWB CIRCUIT DIAGRAMS (2/2) [AV-29LX2, AV-29LX2/A, AV-2968TEE]

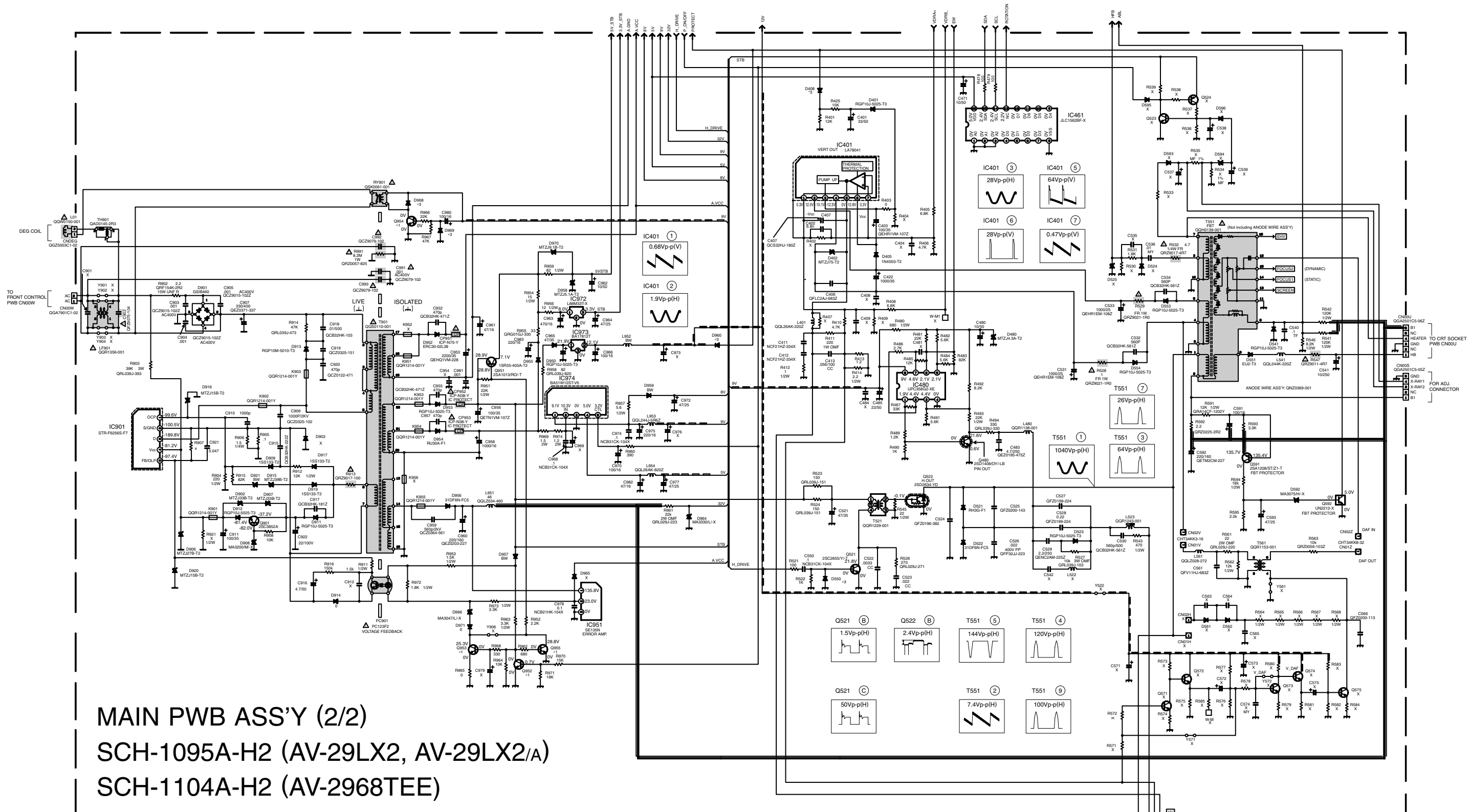

MAIN PWB ASS'Y (2/2)
 SCH-1095A-H2 (AV-29LX2, AV-29LX2/A)
 SCH-1104A-H2 (AV-2968TEE)

NOTE
 *1: 2SC2412K/QRV-X
 *3: MA111-X
 BW: BUS WIRE
 X: NON MOUNT (OPEN)
 0: NRS463J-DROX

CRT SOCKET PWB ASS'Y
 SCH-3005A-H2

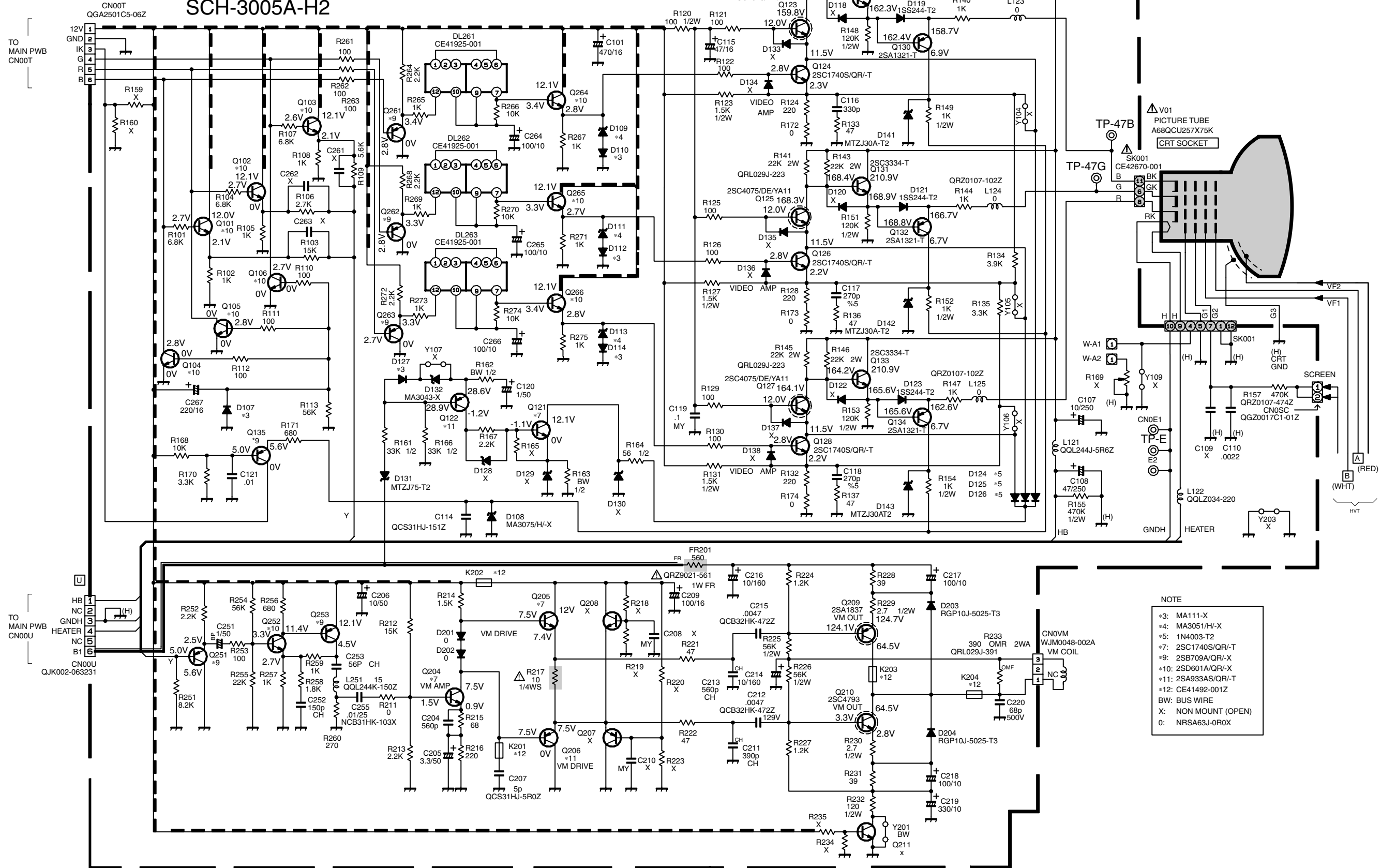

NOTE

- *3: MA111-X
- *4: MA3051/H-X
- *5: 1N4003-T2
- *7: 2SC1740S/QR/-T
- *9: 2SB709A/QR/-X
- *10: 2SD601A/QR/-X
- *11: 2SA933AS/QR/-T
- *12: CE41492-001Z
- BW: BUS WIRE
- X: NON MOUNT (OPEN)
- 0: NRSA63J-0R0X

FRONT CONTROL PWB CIRCUIT DIAGRAM

AV-29LS2
AV-29LX2
AV-2968TEE

AV-29LS2
AV-29LX2
AV-2968TEE

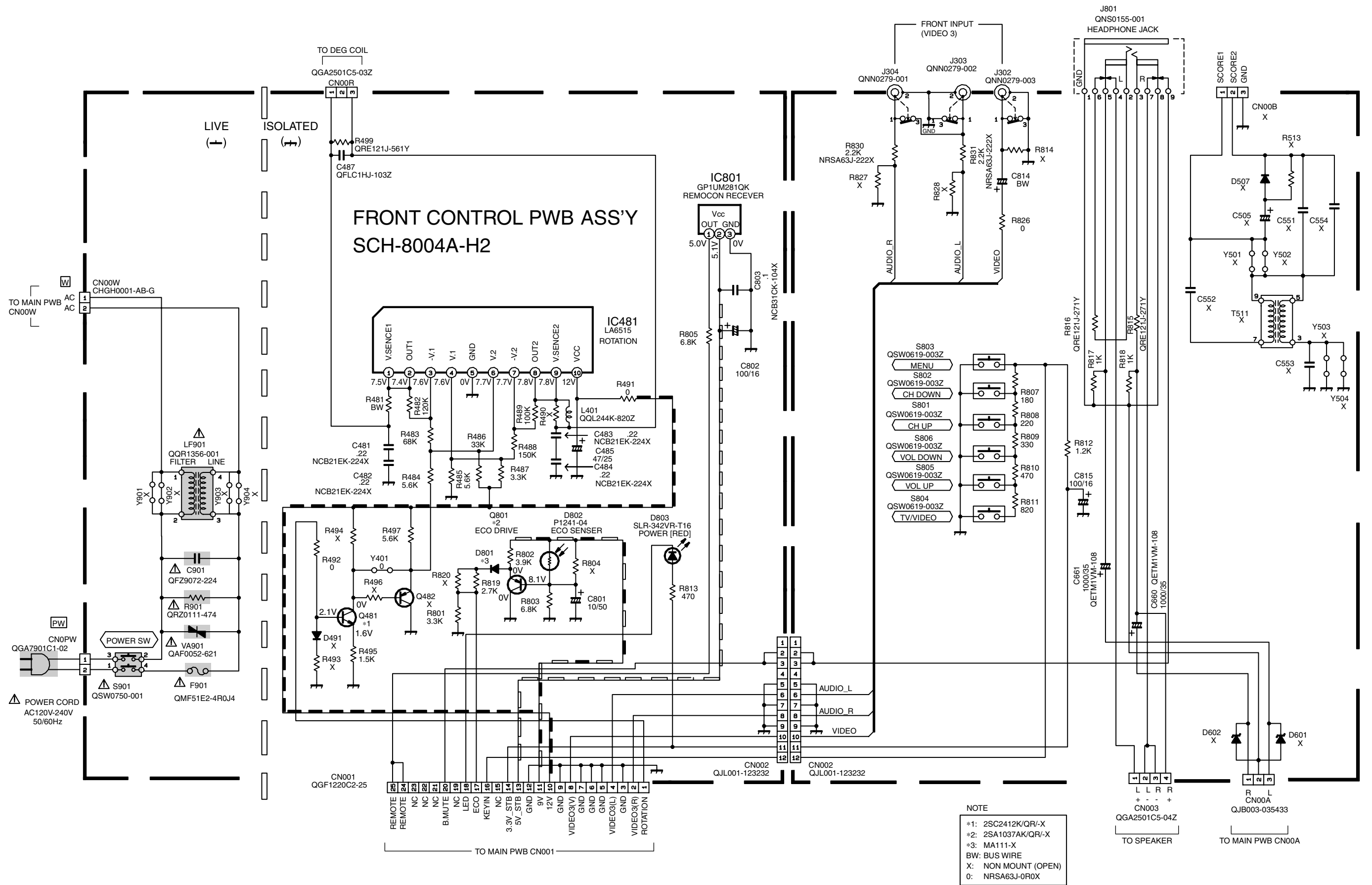

NOTE
*1: 2SC2412K/QR/-X
*2: 2SA1037AK/QR/-X
*3: MA111-X
BW: BUS WIRE
X: NON MOUNT (OPEN)
0: NRSA63J-0R0X

SPECIFICATIONS

Items		Contents			
		AV-29LS2	AV-29LX2	AV-29LX2/A	AV-2968TEE
Dimensions (W × H × D)		73.2cm × 58.8cm × 51.8cm			
Mass		47kg			
TV RF System		B, G, I, D, K, K1, M			
Colour System	TV Mode	PAL / SECAM / NTSC3.58 / NTSC4.43			
	VIDEO Mode	PAL / SECAM / NTSC3.58 / NTSC4.43			
Stereo system		A2 / NICAM (B/G, I, D/K) system	Playback only		
Teletext system FLOF(Fastext), WST(World Standard Text)		○	—	○	
Receiving Frequency	VHF (VL)	46.25MHz – 140.25MHz	(AS0 – S6)		
	VHF (VH)	147.25MHz – 423.25MHz	(S7 – S36)		
	UHF	431.25MHz – 863.25MHz	(S37 – CHINA 57)		
	CATV	● Cable TVs of Mid (X-Z, S1-S10) Super (S11-S20) & Hyper (S21-S41) bands receivable			
Intermediate Frequency	VIF Carrier	38.0MHz			
	SIF Carrier	31.5MHz (6.5MHz)			
		32.0MHz (6.0MHz)			
		32.5MHz (5.5MHz)			
33.5MHz (4.5MHz)					
Colour Sub Carrier Frequency		PAL (4.43MHz), SECAM (4.40625MHz / 4.25MHz) NTSC (3.58MHz / 4.43MHz)			
Aerial Input Terminal		75Ω Unbalanced			
Power Input		AC110 – 240V, 50 / 60Hz			
Power Consumption		175W (Max.) / 116W (Avg.)			
Picture Tube		Visible size : 68cm measured diagonally			
High Voltage		32.0kV +1/ – 1.5kV (at cut-off in service mode)			
Speaker		5 × 12cm Oval type x2			
Audio Output		7W + 7W			
Video / Audio Input (1 / 2 / 3)		Video(1,3) : 1Vp-p, 75Ω (RCA pin jack) Audio(1,2,3) : 500mVrms (-4dBs), High Impedance (RCA pin jack) Component Input (Input 2) Y : 1Vp-p positive (negative sync provided, when terminated with 75Ω) Cb/CR : 0.7Vp-p 75Ω			
Video/Audio Output		1Vp-p, 75Ω (RCA pin jack) 500mVrms(-4dBs) Low impedance (400Hz when modulated 100%) (RCA pin jack)			
Headphone Jack		Stereo mini jack (3.5φ)			
Remote Control Unit		RM-C1020-1H	RM-C1024-1H	RM-C1023-1H	
		(Battery size: AA/R06/UM-3 × 2)			

Design & specifications are subject to change without notice.

FUNCTIONS

FRONT PANEL

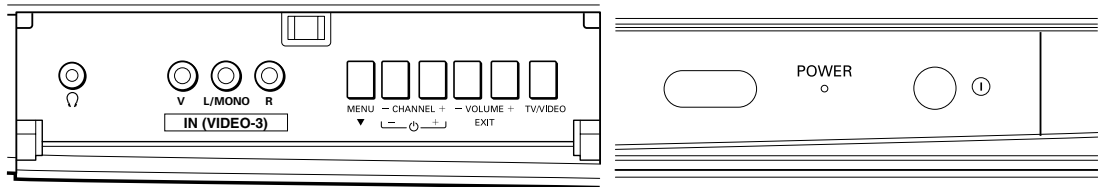

REAR PANEL

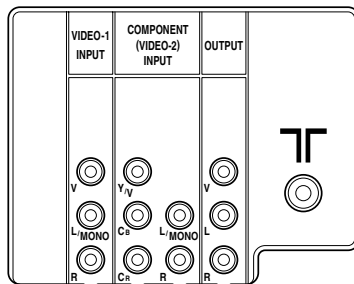

REMOTE CONTROL UNIT

RM-C1020-1H
[AV-29LS2]

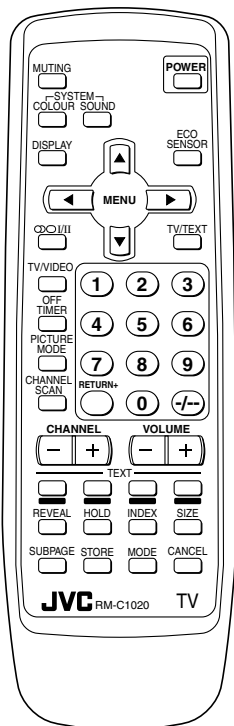

RM-C1024-1H
[AV-29LX2]
[AV-29LX2/A]

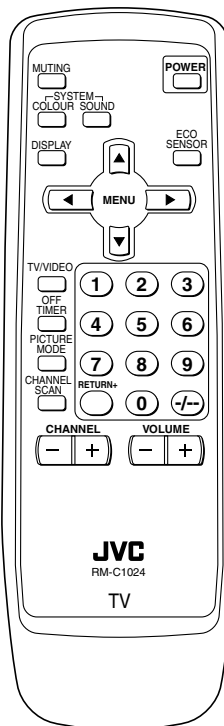

RM-C1023-1H
[AV-2968TEE]

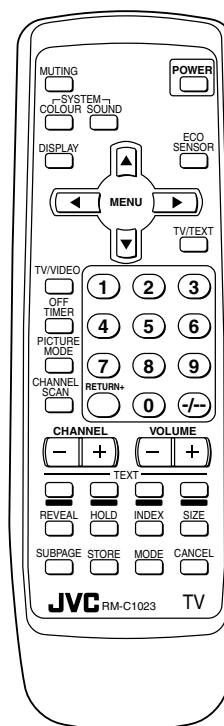

SPECIFIC SERVICE INSTRUCTIONS

DISASSEMBLY PROCEDURE

REMOVING THE REAR COVER

1. Unplug the power supply cord.
2. Remove the 16 screws marked (A) as shown in Fig.1.
3. Withdraw the Rear cover toward you.

[CAUTION]

- When reinstalling the rear cover, carefully push it inward after inserting the Main PWB into the rear cover groove.

REMOVING THE CHASSIS (CHASSIS BASE AND CONTROL BASE)

- After removing the rear cover.
1. Slightly raise the both sides of the chassis by hand and remove the 2 claws marked (B) under the chassis from the front cabinet as shown in Fig.1.
 2. Withdraw the chassis backward.

(If necessary, take off the wire clamp, connector's etc.)

* When conducting a check with power supplied, be sure to confirm that the CRT earth wire is connected to the CRT SOCKET PWB and the Main PWB.

CHECKING THE MAIN PW BOARD

1. To check the back side of the Main PWB.
 - 1) Pull out the chassis. (Refer to REMOVING THE CHASSIS).
 - 2) Erect the chassis vertically so that you can easily check the back side of the Main PWB.

[CAUTION]

- When erecting the chassis, be careful so that there will be no contacting with other PW Board.
- Before turning on power, make sure that the CRT earth wire and other connectors are properly connected.
- When repairing, connect the Deg. coil to the DEG. connector on the Main PWB.

WIRE CLAMPING AND CABLE TYING

1. Be sure to clamp the wire.
2. Never remove the cable tie used for tying the wires together. Should it be inadvertently removed, be sure to tie the wires with a new cable tie.

REMOVING THE AV TERMINAL BOARD

- After removing the rear cover.
1. Remove the 4 screws marked (C) as shown in Fig.1.
 2. When you pull out the AV Terminal board in the direction of arrow marked (D) as shown in Fig.1, it can be removed.

REMOVING THE CONTROL BASE

- After removing the rear cover and the chassis.
1. While pushing down the 2 claws marked (E) as shown in Fig. 2 and pull out the Control base in the direction of arrow marked (F) as shown in Fig. 2, the control base can be removed.
(If necessary, take off the wire, connector's etc.)

REMOVING THE SPEAKER

- After removing the rear cover.
1. Remove the 4 screws marked (G) and 2 screws marked (H) as shown in Fig.1.
 2. Withdraw the speaker backward.
 3. Follow the same steps when removing the other hand speaker.

REPLACEMENT OF MEMORY IC

1. MEMORY IC

This TV uses the following memory IC.

Memory IC: IC1702 on MAIN PW Board

The memory IC memorizes data for correctly operating the video and deflection circuits. When replacing the memory IC, be sure to use the same type IC written with the initial values of data. In other words, use the specific IC listed in "PRINTED WIRING BOARD PARTS LIST". For its mounting location, refer to "ADJUSTMENT LOCATIONS".

2. PROCEDURE FOR REPLACING MEMORY IC

(1) Power off

Switch the power off and unplug the power cord from the wall outlet.

(2) Replacing the memory IC

Replace the memory IC with new one. Be sure to use the memory IC written with the initial data values.

(3) Power on

Plug the power cord into the wall outlet and switch the power on.

(4) Check and setting of SYSTEM CONSTANT SET:

1) Press the DISPLAY key and the PICTURE MODE key on the remote control unit simultaneously.

The SERVICE MENU screen will be displayed.(See Fig.1.)

2) In the SERVICE MENU, press the DISPLAY key and PICTURE MODE key simultaneously. Then, the SYSTEM CONSTANT SET screen will be displayed.(See Fig.2.)

3) Check whether the setting values of the SYSTEM CONSTANT SET are the same as those indicated in Table1.

If the value is different, select the setting item with the MENU ∇/Δ key, and set the correct value with the MENU $\triangleleft/\triangleright$ key.

4) Press the DISPLAY key twice to return to the normal screen.

(5) Receive channel setting

Refer to the **OPERATING INSTRUCTIONS** and set the receive channels (channels preset).

(6) User setting

Check the user setting values in Table 2, and if setting value is different, set the correct value.

For setting, refer to the **OPERATING INSTRUCTIONS**.

(7) Setting of SERVICE MENU

Verify the setting for each setting item in the SERVICE MENU.(See Table 3.) If readjustment is necessary, perform adjustment referring to "SERVICE ADJUSTMENTS".

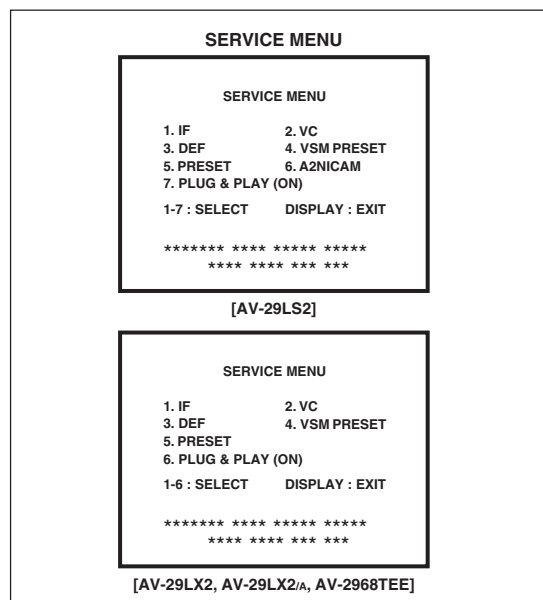
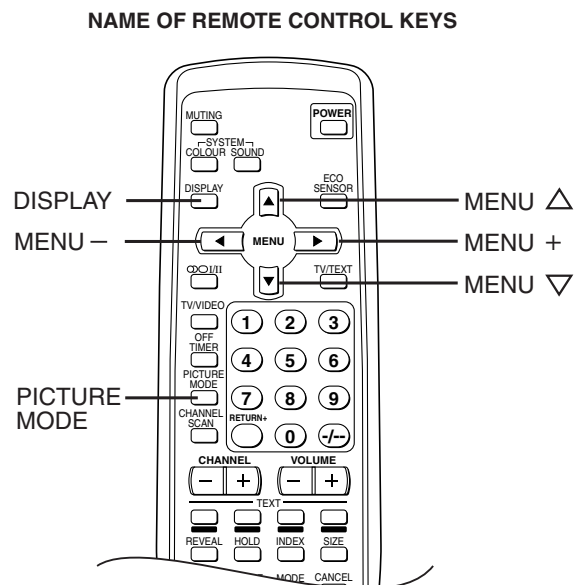

Fig. 1

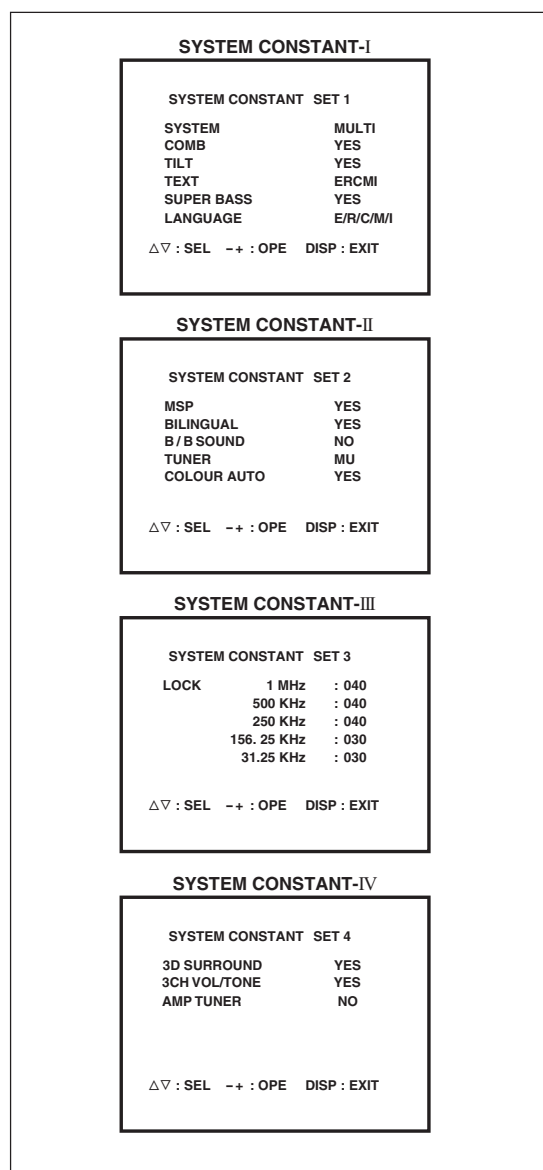

Fig. 2

SETTING OF SYSTEM CONSTANT SET

Setting item	Setting content	Setting value			
		AV-29LS2	AV-29LX2	AV-29LX2/A	AV-2968TEE
SYSTEM	→ MULTI → TRIPLE → PAL → SINGLE → VIET ←	MULTI	←	←	←
COMB	→ YES → NO ←	YES	←	←	←
TILT	→ YES → NO ←	YES	←	←	←
TEXT	→ ERCMI → ERAPU → NO ←	ERCMI	NO	←	ERAPU
SUPER BASS	→ YES → NO ←	NO	←	←	←
LANGUAGE	→ E/R/C/M/I → E/R/C → E/C ←	E/R/C/M/I	-	-	-
	→ E/R/A/P/U → E/R/A/P → E/R/U ←	-	E/R/A/P	←	E/R/A/P/U
MSP	→ YES → NO ←	YES	NO	←	←
BILINGUAL	→ YES → NO ←	NO	←	←	←
B/B SOUND	→ YES → NO ←	NO	←	YES	NO
TUNER	→ MU → MA ←	MU	←	←	←
COLOUR AUTO	→ YES → NO ←	NO	←	YES	NO
LOCK 1MHz	→ 000 → 240 ←	040	←	←	←
500KHz	→ 000 → 240 ←	040	←	←	←
250KHz	→ 000 → 240 ←	040	←	←	←
156.25KHz	→ 000 → 240 ←	030	←	←	←
31.25KHz	→ 000 → 240 ←	030	←	←	←
3D SURROUND	→ YES → NO ←	NO	←	←	←
3CH VOL/TONE	→ YES → NO ←	YES	←	←	←
AMP TUNER	→ YES → NO ←	NO	←	←	←

Table 1

USER SETTING VALUES

Setting item	Setting value
SUB POWER	ON
CHANNEL POSITION	1 POSITION
CHANNEL PRESET	REFER TO OPERATING INSTRUCTIONS
VOLUME	15 ± 2
TV/VIDEO	TV
VNR	OFF
COMPRESS (16:9)	OFF
AUTO SHUTOFF	OFF
CHILD LOCK	OFF
BLUE BACK	ON
VIDEO-2 SET	VIDEO
LANGUAGE	ENG
AI VOLUME	ON
ON SCREEN DISPLAY	POSITION INDICATION
COLOUR SYSTEM	PAL
SOUND SYSTEM	B/G
STEREO MODE	STEREO [AV-29LS2 only]
PICTURE MODE-VSM	BRIGHT
OFF TIMER	00
ECO SENSOR	OFF
BASS	CENTRE
TREBLE	CENTRE
BALANCE	CENTRE

Table 2

SERVICE MENU SETTING ITEMS

Service menu	Setting item	Service menu	Setting item
1. IF	1. VCO 2. DELAY POINT	5. PRESET Do not adjust	1. PSNS 2. ACL 3. MUS 4. MAT 5. FCO 6. BPS 7. IFLH 8. VID 9. STM 10. AFCW 11. VSW 12. FFI 13. AGC 14. CL 15. AKB 16. HBL 17. BKS 18. READ STATUS 19. VNR 20. PEAK 21. IVG 22. WPL 23. SOFT CLIPPER 24. IF PLL OFFSET 25. OVERSHOOT 26. HCO 27. HP2 28. AI VOLUME ADN 31. CCCLOOP
2. VC	1. CUTOFF(R/G) 2. DRIVE(R/G/B) 3. BRIGHT 4. CONT 5. COLOUR 6. TINT 7. SHARP 8. YDELAY 9. AMP T. SHARP		Do not adjust
3. DEF	1. VER. SLOPE 2. VER. HEIGHT 3. VER. POSITION 4. VER. SCURVE 5. HOR. POSITION 6. HOR. WIDTH 7. EW-PIN 8. EW-TRAPEZ 9. UP CORNER 10. DW CORNER 11. HOR. PARALL 12. HOR. BOW 13. V. ZOOM		
4. VSM PRESET (BRIGHT/STD/SOFT) Do not adjust	1. TINT 2. COLOUR 3. BRIGHT 4. PICTURE 5. DETAIL		6. A2NICAM [AV-29LS2 only] Do not adjust
		6/7. PLUG & PLAY(ON) Do not adjust	

Table 3

SERVICE ADJUSTMENTS

ADJUSTMENT PREPARATION

1. You can make the necessary adjustments for this unit with either the remote control unit or with the adjustment equipment and parts as given below.
2. Adjustment with the remote control unit is made on the basis of the initial setting values, however, the new setting values which set the screen to its optimum condition may differ from the initial settings.
3. Make sure that AC power is turned on correctly.
4. Turn on the power for the set and test equipment before use, and start the adjustment procedures after waiting at least 30 minutes.
5. Unless otherwise specified, prepare the most suitable reception or input signal for adjustment.
6. Never touch any adjustment parts, which are not specified in the list for this adjustment-variable resistors, transformers, capacitors, etc.
7. Presetting before adjustment.

Unless otherwise specified in the adjustment instructions, preset the following functions with the remote control unit.

- User mode setting position

Setting item	Setting value
PICTURE MODE(VSM)	BRIGHT
VNR	OFF
BASS, TREBLE, BALANCE	CENTRE
TINT, COLOUR, BRIGHT, DETAIL	CENTRE
PICTURE	MAXIMUM

MEASURING INSTRUMENT

1. DC voltmeter (or Digital voltmeter)
2. Oscilloscope
3. Signal generator (Pattern generator) [PAL/SECAM/NTSC]
4. Remote control unit

ADJUSTMENT ITEMS

- B1 POWER SUPPLY
- FOCUS ADJUSTMENT
- IF CIRCUIT ADJUSTMENTS
 - Adjustment of VCO (CW)
 - Adjustment of DELAY POINT (AGC TAKE-OVER)
- VC (VIDEO/CHROMA) CIRCUIT ADJUSTMENTS
 - Adjustment of WHITE BALANCE (Low light)
 - Adjustment of WHITE BALANCE (High light)
 - Adjustment of SUB BRIGHT
 - Adjustment of SUB CONTRAST
 - Adjustment of SUB COLOUR-I
 - Adjustment of SUB COLOUR-II
 - Adjustment of SUB TINT-I
 - Adjustment of SUB TINT-II
- DEFLECTION CIRCUIT ADJUSTMENTS
 - Adjustment of V. SLOPE
 - Adjustment of V. POSITION
 - Adjustment of V. HEIGHT
 - Adjustment of H. POSITION
 - Adjustment of H. WIDTH
 - Adjustment of SIDE PIN
 - Adjustment of TRAPEZIUM
 - Adjustment of V. S-CURVE
 - Adjustment of CORNER
 - Adjustment of H. PARALLEL
 - Adjustment of H. BOW
- VSM PRESET SETTING
- PRESET SETTING
- AUDIO ADJUSTMENT [AV-29LS2 only]
- PURITY ADJUSTMENT
- CONVERGENCE ADJUSTMENTS
 - Adjustment of STATIC CONVERGENCE
 - Adjustment of DYNAMIC CONVERGENCE

BASIC OPERATION IN SERVICE MENU

1. TOOL OF SERVICE MENU OPERATION

Operate the SERVICE MENU with the remote control unit.

2. SERVICE MENU ITEMS

With the SERVICE MENU, various settings (adjustments) can be made, and they are broadly classified in the following items of settings:

- 1. IF For entering/adjusting the setting values (adjustment values) of the IF circuit.
- 2. VC For entering/adjusting the setting values (adjustment values) of the VIDEO/CHROMA circuit.
- 3. DEF For entering/adjusting the setting values (adjustment values) of the DEFLECTION circuit.
- 4. VSM PRESET For setting the values of STANDARD, SOFT and BRIGHT.
(VSM: video status memory)
- 5. PRESET For setting the values of the preset.
- 6. A2NICAM For entering/adjusting the setting values (adjustment values) of the multiplicity sound circuit. [AV-29LS2 only]
- 6/7. PLUG & PLAY (ON) This is not used for service.

3. BASIC OPERATION IN SERVICE MENU

(1) How to enter SERVICE MENU

Press the DISPLAY key and the PICTURE MODE key on the remote control unit simultaneously.
The SERVICE MENU screen will be displayed. (See Fig. 1 on the next page.)

(2) Selection of SUB MENU SCREEN

Press one of the keys 1 to 7 on the remote control unit, and select the SUB MENU SCREEN from the SERVICE MENU. (See Fig. 1 on the next page.)

SERVICE MENU → SUB MENU	1. IF
	2. VC
	3. DEF
	4. VSM PRESET
	5. PRESET
	6. A2NICAM [AV-29LS2 only]
	6/7. PLUG & PLAY (ON)

(3) Method of Setting

*Once the setting values are set, they are memorized automatically.

*It must not adjust without inputting a signal.

1) 1. IF

[1. VCO]

- (a) 1 Key Select **1. IF**.
- (b) 1 Key Select **1. VCO**.
- (c) DISPLAY Key When this is pressed twice, you will return to the SERVICE MENU.
 - Under normal conditions, no adjustment is required.

[2. DELAY POINT]

- (a) 1 Key Select **1. IF**.
- (b) 2 Key Select **2. DELAY POINT**.
- (c) MENU </> Key Adjust the setting value.
- (d) DISPLAY Key When this is pressed twice, you will return to the SERVICE MENU.

2) 2. VC, 3. DEF, 4. VSM PRESET, 5. PRESET and 6. A2NICAM

- (a) 2 ~6 Keys Select one from **2. VC**, **3. DEF**, **4. VSM PRESET**, **5. PRESET** and **6. A2NICAM**.
- (b) MENU ∇/△ key Select setting items.
- (c) MENU </> Key Adjust the setting values of the setting items.
 - Use the number keys on the remote control unit for setting of WHITE BALANCE.
For the setting, refer to each item concerned.
- (d) DISPLAY Key When this is pressed, you will return to the SERVICE MENU.

3) 6/7. PLUG & PLAY (ON)

This is not used for service.

(4) Release of SERVICE MENU

After completing the setting, return to the SERVICE MENU by pressing the DISPLAY key, then again press the DISPLAY key to return to the normal screen.

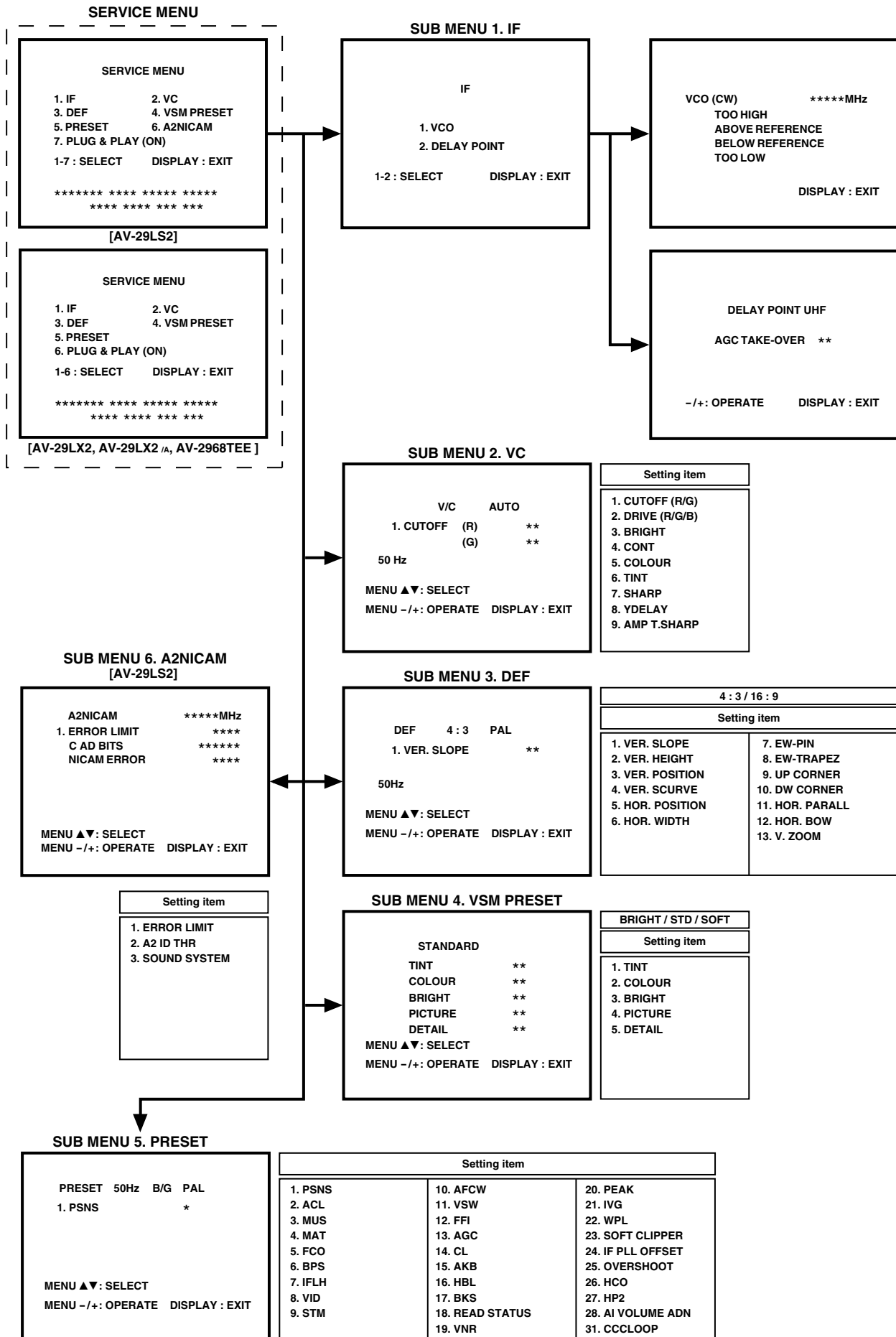

Fig. 1
 No. 52062

ADJUSTMENTS

B1 POWER SUPPLY

Item	Measuring instrument	Test point	Adjustment part	Description
Check of B1 POWER SUPPLY	Signal Generator DC Voltmeter	B1 (pin 1) GND (pin 5) [CN00S connector in MAIN PWB]		<ol style="list-style-type: none"> 1. Receive a black and white signal. 2. Connect a DC voltmeter between B1 and GND (between pins 1 and 5 of the connector CN00S). 3. Make sure that the voltage is DC134.5 ± 2V.

FOCUS ADJUSTMENT

Item	Measuring instrument	Test point	Adjustment part	Description
Adjustment of FOCUS	Signal generator		FOCUS VR [In HVT]	<p>Notes:</p> <ul style="list-style-type: none"> • Set PICTURE MODE (VSM) to "BRIGHT". • The final adjustment of CONVERGENCE must be done after the FOCUS adjustment. (CONVERGENCE is changed by FOCUS adjustment.) <p>When makes difference by FOCUS adjustment, should be reconfirming PURITY adjustment.</p> <ol style="list-style-type: none"> 1. Receive a cross-hatch signal. 2. While looking at the screen centre, adjust the FOCUS VR so that the vertical and horizontal lines will be clear and in fine detail. 3. Make sure that the picture is in focus even when the screen gets darkened.

IF CIRCUIT ADJUSTMENTS

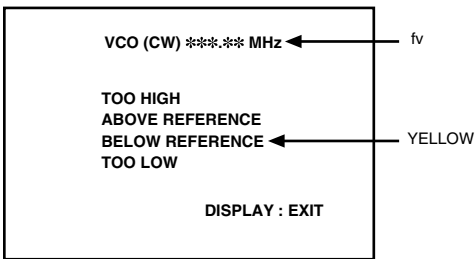
Item	Measuring instrument	Test point	Adjustment part	Description								
Adjustment of VCO (CW)	Remote control unit		VCO (CW)	<p>Note:</p> <ul style="list-style-type: none"> • Under normal conditions, no adjustment is required. <ol style="list-style-type: none"> 1. Select 1. IF from the SERVICE MENU. 2. Select 1. VCO by pressing the 1 key on the remote control unit. 3. Receive a broadcast signal. 4. Check the characters colour of the BELOW REFERENCE displayed to yellow. 5. Press the DISPLAY key three times to return to normal screen. 								
												
Adjustment of DELAY POINT (AGC TAKE-OVER)	Remote control unit		DELAY POINT	<ol style="list-style-type: none"> 1. Receive a black and white broadcast signal (colour off). 2. Select 1. IF from the SERVICE MENU. 3. Select 2. DELAY POINT by pressing the 2 key on the remote control unit. 4. Adjust the MENU </> key in order to eliminate any noise or beat from the image. Any increase above the initial value produces noise and any decrease below it produces beat. 5. Press the DISPLAY key three times to return to the normal screen. 6. Turn to other channels and make sure that there are no irregularities. 								
<table border="1" style="margin-left: auto; margin-right: auto;"> <thead> <tr> <th rowspan="2">Setting (Adjustment time)</th> <th colspan="2">Initial setting value</th> </tr> <tr> <th>NTSC 3.58</th> <th>OTHERS</th> </tr> </thead> <tbody> <tr> <td>DELAY POINT (AGC TAKE-OVER)</td> <td>30</td> <td>26</td> </tr> </tbody> </table>					Setting (Adjustment time)	Initial setting value		NTSC 3.58	OTHERS	DELAY POINT (AGC TAKE-OVER)	30	26
Setting (Adjustment time)	Initial setting value											
	NTSC 3.58	OTHERS										
DELAY POINT (AGC TAKE-OVER)	30	26										

VC (VIDEO/CHROMA) CIRCUIT ADJUSTMENTS

The setting (adjustment) using the remote control unit is made on the basis of the initial setting values.
The setting values which adjust the screen to the optimum condition can be different from the initial setting values.
● Do not change the initial setting values of the setting (adjustment) items not listed in "ADJUSTMENT".

[SUB MENU 2. VC] : Do not adjust.

	Setting (Adjustment) item	Variable range	Initial setting value				
			PAL	SECAM	NTSC3.58	NTSC4.43	COMPONENT (V-2)
1	CUT-OFF (R/G)	-32 - +31	0/0	←	←	←	-2/+14
2	DRIVE (R/G/B)	-32 - +31	0/0/0	←	←	←	←
3	BRIGHT (TV/V-1/V-2/V-3)	-32 - +31	-13/0/0/+1	←	←	←	-/-/-1/-
4	CONT	-32 - +31	-10	←	←	←	-
5	COLOUR	-32 - +31	-4	-13	-11	+1	0
6	TINT (TV/VIDEO)	-32 - +31	-	-	-15/+2	-/+1	-
7	SHARP (TV/VIDEO)	-32 - +31	-28/-22	←	←	←	-/0
8	Y DELAY (TV/VIDEO)	-8 - +7	-7/+1	←	0/+1	0/0	-/+1
9	AMP T. SHARP	-32 - +31	0	←	←	←	←

Item	Measuring instrument	Test point	Adjustment part	Description
Adjustment of WHITE BALANCE (Low light)	Signal generator		1. CUTOFF (R) CUTOFF (G)	<p>Note:</p> <ul style="list-style-type: none"> Set PICTURE MODE (VSM) to "BRIGHT". <ol style="list-style-type: none"> Receive a PAL black and white signal (colour off). Select 2. VC from the SERVICE MENU. Select 1. CUTOFF (R) and (G) with MENU ∇/Δ key, and set each value to initial setting value with the 4 and 7 keys, or 5 and 8 keys on the remote control unit. Press the 1 key on the remote control unit to produce a single horizontal line. Turn the SCREEN VR fully counterclockwise, then slowly turn it clockwise to where a red, blue or green colour is faintly visible. Use the keys 4 and 7 or 5 and 8 on the remote control unit and adjust the other 2 colours to where the single horizontal line appears white. Turn the SCREEN VR to where the single horizontal line glows faintly. Press the 2 key to return to 1. CUTOFF screen. Press the DISPLAY key twice to return to the normal screen.
	Remote control unit		SCREEN VR [In HVT]	

V/C PAL

1. CUTOFF (R) **

 (G) **

50 Hz

MENU \blacktriangle / \blacktriangledown : SELECT

MENU -/+ : OPERATE DISPLAY : EXIT

REMOTE CONTROL UNIT

Setting (Adjustment) item	Variable range	Initial setting value
1. CUT OFF	R	-32 - +31
	G	-32 - +31

Item	Measuring instrument	Test point	Adjustment part	Description													
Adjustment of WHITE BALANCE (High light)	Signal generator Remote control unit		2. DRIVE (R) DRIVE (G) DRIVE (B)	<p>Notes:</p> <ul style="list-style-type: none"> • Proceed to the following adjustment after having completed the adjustment of LOW LIGHT WHITE BALANCE. • Set PICTURE MODE (VSM) to "BRIGHT". <ol style="list-style-type: none"> 1. Receive a PAL black and white signal (colour off). 2. Select 2. VC from the SERVICE MENU. 3. Select 2. DRIVE (R), (G) and (B) with MENU ∇/Δ key, and set each value to initial setting value with the 4 to 9 keys on the remote control unit. 4. Use the keys 4 to 9 to produce a white screen. 5. Press the DISPLAY key twice to return to the normal screen. <table border="1" data-bbox="808 604 1417 779"> <thead> <tr> <th>Setting (Adjustment) Item</th> <th>Variable range</th> <th>Initial setting value</th> </tr> </thead> <tbody> <tr> <td rowspan="3">2. DRIVE</td> <td>R</td> <td>-32 — +31</td> <td>0</td> </tr> <tr> <td>G</td> <td>-32 — +31</td> <td>0</td> </tr> <tr> <td>B</td> <td>-32 — +31</td> <td>0</td> </tr> </tbody> </table>	Setting (Adjustment) Item	Variable range	Initial setting value	2. DRIVE	R	-32 — +31	0	G	-32 — +31	0	B	-32 — +31	0
Setting (Adjustment) Item	Variable range	Initial setting value															
2. DRIVE	R	-32 — +31	0														
	G	-32 — +31	0														
	B	-32 — +31	0														
Adjustment of SUB BRIGHT	Remote control unit		3. BRIGHT	<p>Notes:</p> <ul style="list-style-type: none"> • Proceed to the following adjustment after having completed the adjustments of LOW LIGHT WHITE BALANCE and HIGH LIGHT WHITE BALANCE. • Set PICTURE MODE (VSM) to "BRIGHT". <ol style="list-style-type: none"> 1. Receive a broadcast. 2. Select 2. VC from the SERVICE MENU. 3. Select 3. BRIGHT with the MENU ∇/Δ key. 4. Set the initial setting value with the MENU $\triangleleft/\triangleright$ key. 5. If the brightness is not best with the initial setting value, make fine adjustment until you get the best brightness. 6. Press the DISPLAY key twice to return to the normal screen. 													
Adjustment of SUB CONTRAST	Remote control unit		4. CONT	<p>Notes:</p> <ul style="list-style-type: none"> • Proceed to the following adjustment after having completed the adjustment of SUB BRIGHT. • Set PICTURE MODE (VSM) to "BRIGHT". <ol style="list-style-type: none"> 1. Receive a broadcast. 2. Select 2. VC from the SERVICE MENU. 3. Select 4. CONT with the MENU ∇/Δ key. 4. Set the initial setting value with the MENU $\triangleleft/\triangleright$ key. 5. If the contrast is not best with the initial setting value, make fine adjustment until you get the best contrast. 6. Press the DISPLAY key twice to return to the normal screen. 													

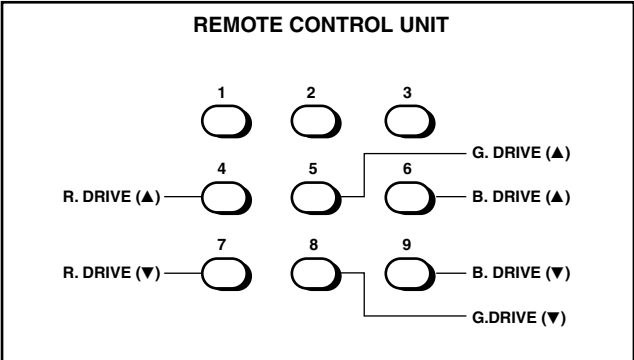
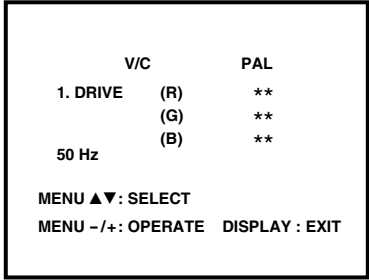

CONVERGENCE ADJUSTMENTS

STATIC CONVERGENCE ADJUSTMENT

1. Input a crosshatch signal.
2. Using 4-pole convergence magnets, overlap the red and blue lines in the center of the screen (Fig. 4) and turn them to magenta (red/blue).
3. Using 6-pole convergence magnets, overlap the magenta (red/blue) and green lines in the centre of the screen and turn them to white.
4. Repeat 2 and 3 above, and make best convergence.

DYNAMIC CONVERGENCE ADJUSTMENT

1. Using the Y_H VR on the deflection yoke, match the Y_H (CROSS). (Fig. 5 and 8)
2. Using the Y_V VR on the deflection yoke, match the Y_V . (Fig. 6 and 8)
3. Repeat the steps 1 and 2, obtain an optimum convergence.
4. Differential coil ADJUSTMENT.
 In case where the horizontal lines of red and blue around the center of both sides of the picture as shown in Fig. 7, adjust the X_v difference by using the differential coil on the top of the deflection yoke (Fig. 8) so as to minimize the X_v difference.

- After adjustment, fix the wedge at the original position.
 Fasten the retainer screw of the deflection yoke.
 Fix the P/C magnet with glue.

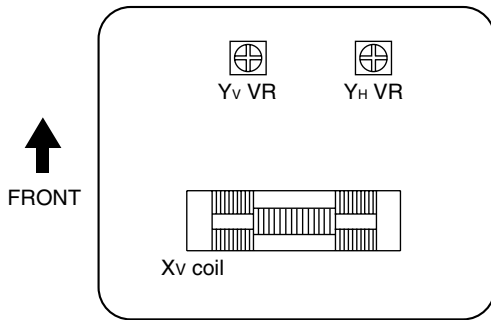

Fig. 8

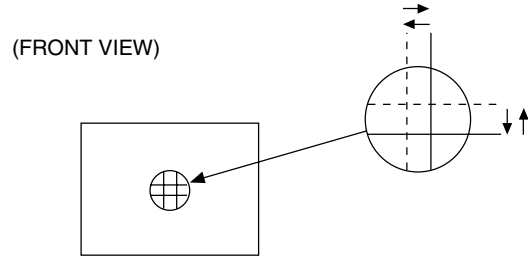

Fig. 4

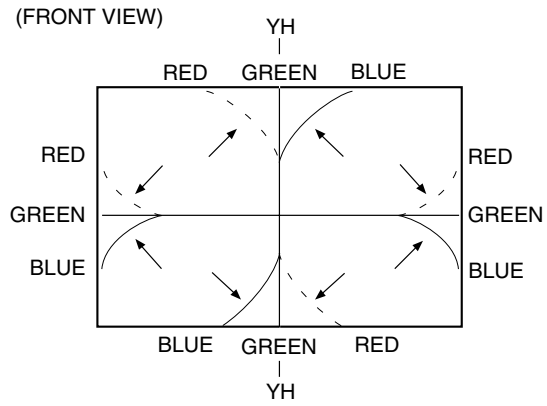

Fig. 5

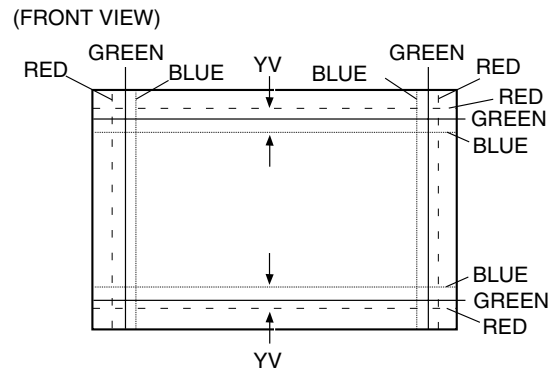

Fig. 6

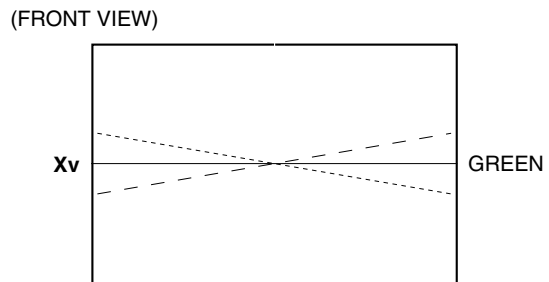

Fig. 7

SELF-CHECK FUNCTIONS

1. Outline

This model has self-check functions given below. When an abnormality has been detected, the SUB POWER is turned off and both ECO and ON TIMER LEDs flash to inform of the failure. An abnormality is detected by the signal input state of the control line connected to the microcomputer.

2. Self check items

Check item	Details of detection	Method of detection	State of abnormality
Over-current protection	An over-current on the low B line is detected.	The main microcomputer detects the possible abnormality at 30-msec.intervals and judges the results in every 16 time. Of the 16 times, if NG is detected more than 9 times, it is judged that there is an abnormality.	When an abnormality has been detected, the SUB-POWER is turned off. While the SUB-POWER is being turned off, the POWER key on the remote control unit is not operational until the power cord is taken out and put in again.
CRT NECK protection	Operation of CRT NECK protection circuit	DITTO	DITTO

3. Self check indicating function

When an abnormality has been detected at about 5 seconds after the power is turned on, the SUB POWER is turned off immediately and the LEDs flash.

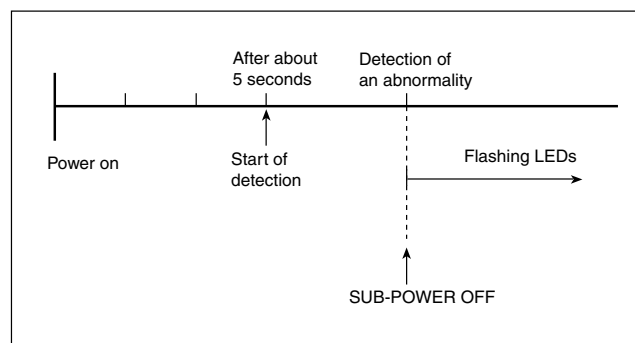

[Indication by the LEDs]

Item	LEDs flashing intervals	Priority of detection
① Over-current protection	At 0.2-second intervals	1
② CRT NECK protection	At 1-second intervals	2

Note: In case of ① + ②, the item ① is indicated.