



website:<http://biz.LGservice.com>  
e-mail:<http://www.LGservice.com/techsup.html>

# COLOR TV

# SERVICE MANUAL

CHASSIS : MC-049B

**MODEL:RT-21FA35R/RX/V/VX**  
**RT-21FA315EX/PX**

## CAUTION

BEFORE SERVICING THE CHASSIS,  
READ THE SAFETY PRECAUTIONS IN THIS MANUAL.

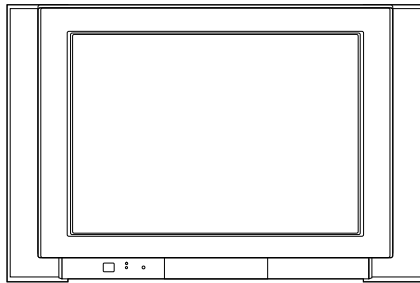

# CONTENTS

|                                       |           |
|---------------------------------------|-----------|
| <b>Contents .....</b>                 | <b>2</b>  |
| <b>Safety Precautions.....</b>        | <b>3</b>  |
| <b>Control Descriptions.....</b>      | <b>4</b>  |
| <b>Specifications .....</b>           | <b>7</b>  |
| <b>Adjustment Instructions .....</b>  | <b>8</b>  |
| <b>Trouble Shooting.....</b>          | <b>12</b> |
| <b>Printed circuit board.....</b>     | <b>16</b> |
| <b>Block Diagram .....</b>            | <b>19</b> |
| <b>Exploded View .....</b>            | <b>20</b> |
| <b>Exploded View Parts List .....</b> | <b>21</b> |
| <b>Replacement Parts List .....</b>   | <b>22</b> |
| <b>SVC. Sheet.....</b>                | <b></b>   |

# SAFETY PRECAUTIONS

## IMPORTANT SAFETY NOTICE

Many electrical and mechanical parts in this chassis have special safety-related characteristics. These parts are identified by  $\Delta$  in the Schematic Diagram and Replacement Parts List. It is essential that these special safety parts should be replaced with the same components as recommended in this manual to prevent X-RADIATION, Shock, Fire, or other Hazards. Do not modify the original design without permission of manufacturer.

### General Guidance

An **isolation Transformer should always be used** during the servicing of a receiver whose chassis is not isolated from the AC power line. Use a transformer of adequate power rating as this protects the technician from accidents resulting in personal injury from electrical shocks.

It will also protect the receiver and its components from being damaged by accidental shorts of the circuitry that may be inadvertently introduced during the service operation.

If any fuse (or Fusible Resistor) in this TV receiver is blown, replace it with the specified.

When replacing a high wattage resistor (Oxide Metal Film Resistor, over 1W), keep the resistor 10mm away from PCB.

Keep wires away from high voltage or high temperature parts.

Due to high vacuum and large surface area of picture tube, extreme care should be used in **handling the Picture Tube**. Do not lift the Picture tube by its Neck.

### X-RAY Radiation

#### Warning:

The source of X-RAY RADIATION in this TV receiver is the High Voltage Section and the Picture Tube. For continued X-RAY RADIATION protection, the replacement tube must be the same type tube as specified in the Replacement Parts List.

To determine the presence of high voltage, use an accurate high impedance HV meter.

Adjust brightness, color, contrast controls to minimum. Measure the high voltage.

The meter reading should indicate

23.5 ; 1.5KV: 14-19 inch, 26 ; 1.5KV: 19-21 inch,  
29.0 ; 1.5KV: 25-29 inch, 30.0 ; 1.5KV: 32 inch

If the meter indication is out of tolerance, immediate service and correction is required to prevent the possibility of premature component failure.

### Before returning the receiver to the customer,

always perform an **AC leakage current check** on the exposed metallic parts of the cabinet, such as antennas, terminals, etc., to be sure the set is safe to operate without damage of electrical shock.

#### Leakage Current Cold Check(Antenna Cold Check)

With the instrument AC plug removed from AC source, connect an electrical jumper across the two AC plug prongs. Place the AC switch in the on position, connect one lead of ohm-meter to the AC plug prongs tied together and touch other ohm-meter lead in turn to each exposed metallic parts such as antenna terminals, phone jacks, etc.

If the exposed metallic part has a return path to the chassis, the measured resistance should be between  $1M\Omega$  and  $5.2M\Omega$ .

When the exposed metal has no return path to the chassis the reading must be infinite.

Another abnormality exists that must be corrected before the receiver is returned to the customer.

#### Leakage Current Hot Check (See below Figure)

Plug the AC cord directly into the AC outlet.

**Do not use a line Isolation Transformer during this check.**

Connect 1.5K/10watt resistor in parallel with a 0.15uF capacitor between a known good earth ground (Water Pipe, Conduit, etc.) and the exposed metallic parts.

Measure the AC voltage across the resistor using AC voltmeter with 1000 ohms/volt or more sensitivity.

Reverse plug the AC cord into the AC outlet and repeat AC voltage measurements for each exposed metallic part. Any voltage measured must not exceed 0.75 volt RMS which corresponds to 0.5mA.

In case any measurement is out of the limits specified, there is possibility of shock hazard and the set must be checked and repaired before it is returned to the customer.

#### Leakage Current Hot Check circuit

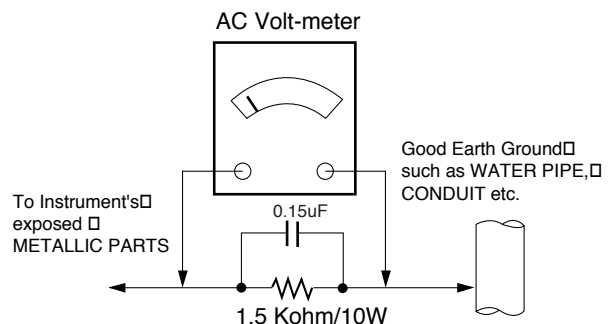

# DESCRIPTION OF CONTROLS

All the functions can be controlled with the remote control handset. Some functions can also be adjusted with the buttons on the front panel of the set.

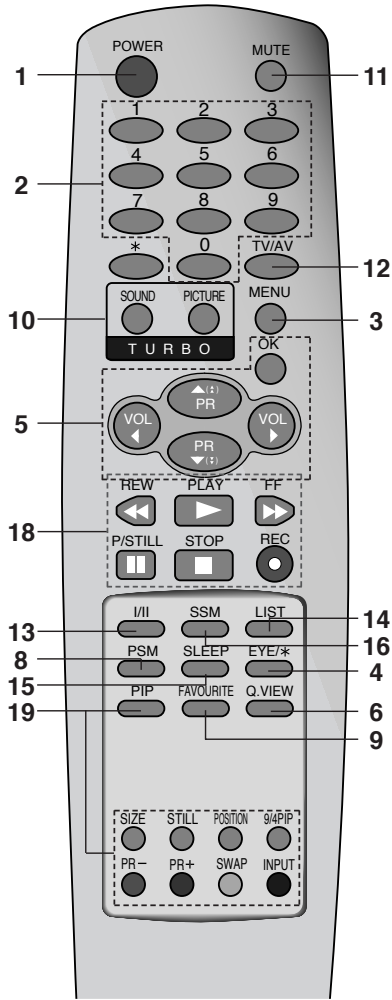

(Without TELETEXT / With PIP)

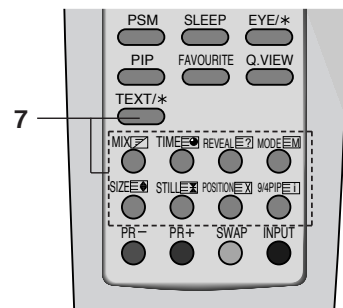

(With TELETEXT / PIP)

## Remote control handset

Before you use the remote control handset, please install the batteries. See the next page.

1. **POWER**  
switches the set on from standby or off to standby.
2. **NUMBER BUTTONS**  
switches the set on from standby or directly select a number.
3. **MENU**  
selects a menu.
4. **EYE/\* (option)**  
switches the eye function on or off.
5. **▲ / ▼ (Programme Up/Down)**  
selects a programme or a menu item.  
**◀ / ▶ (Volume Up/Down)**  
adjusts the volume.
6. **Q.VIEW**  
returns to the previously viewed programme.
7. **TELETEXT BUTTONS (option)**  
These buttons are used for teletext. For further details, see the 'Teletext' section.
8. **PSM (Picture Status Memory)**  
recalls your preferred picture setting.
9. **FAVOURITE**  
selects a favorite programme.
10. **TURBO PICTURE / SOUND BUTTON (option)**  
selects Turbo picture and sound.
11. **MUTE**  
switches the sound on or off.
12. **TV/AV**  
selects TV or AV mode.  
switches the set on from standby.

**13. I/II/\* (option)**  
 selects the language during dual language broadcast. (option)  
 selects the sound output.

**14. LIST**  
 displays the programme table.

**15. SLEEP**  
 sets the sleep timer.

**16. SSM/\* (option) (Sound Status Memory)**  
 recalls your preferred sound setting.

**17. SURROUND (◀▶/\*) (option)**  
 selects surround sound.

**18. VCR BUTTONS**  
 control a LG video cassette recorder.

**19. PIP BUTTONS (option)**  
**PIP**  
 switches the sub picture on or off.  
**PR +/-**  
 selects a programme for the sub picture.  
**SWAP**  
 alternates between main and sub picture.  
**INPUT**  
 selects the input mode for the sub picture.  
**SIZE**  
 adjusts the sub picture size.  
**STILL**  
 freezes motion of the sub picture.  
**POSITION**  
 relocates the sub picture in clockwise direction.  
**9/4 PIP**  
 switches on or off the 9 or 4 sub pictures.

**\* : No function**

**COLOURED BUTTONS** : These buttons are used for teletext (only TELETEXT models) or programme edit.

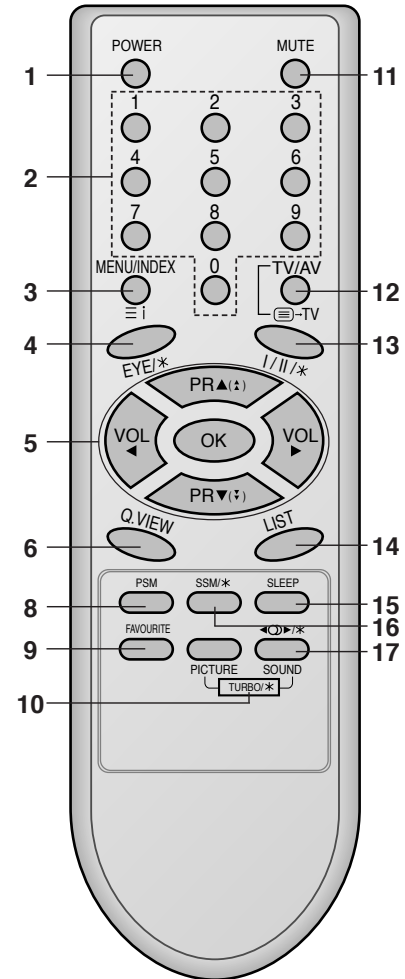

(Without TELETEXT / PIP)

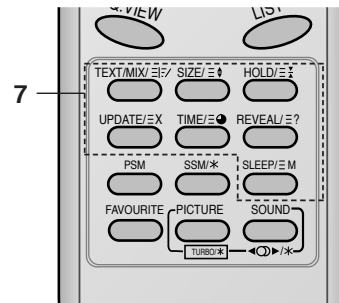

(With TELETEXT / Without PIP)

## Front panel

### RF/RT-21FA35 series

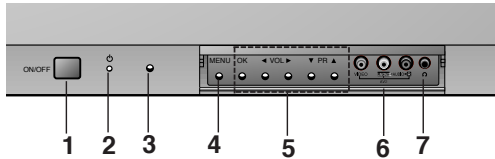

1. **MAIN POWER (ON/OFF)**  
switches the set on or off.
2. **POWER/STANDBY INDICATOR**  
illuminates brightly when the set is in standby mode.  
dims when the set is switched on.  
blinks when signal is input from the remote control.

### RF/RT-21FB25 series

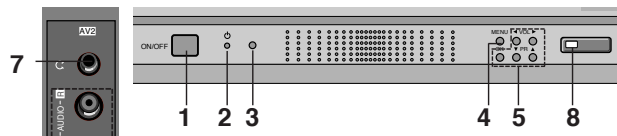

3. **REMOTE CONTROL SENSOR**
4. **MENU**  
selects a menu.
5. **OK**  
accepts your selection or displays the current mode.

### RF/RT-15/21FB55 series

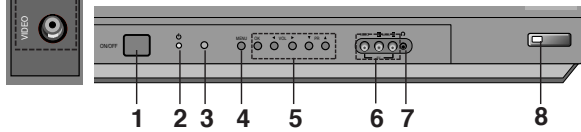

- ◀ / ▶ (**Volume Up/Down**)  
adjusts the volume.  
adjusts menu settings.
  - ▲ / ▼ (**Programme Up/Down**)  
selects a programme or a menu item.  
switches the set on from standby.

### RF/RT-17/21FB75 series

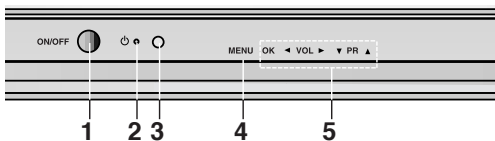

6. **AUDIO/VIDEO IN SOCKETS (AV2) (option)**  
Connect the audio/video out sockets of external equipment to these sockets.

### RF/RT-21FC45 series

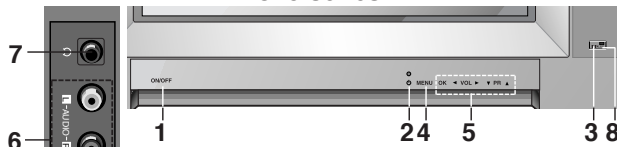

7. **HEADPHONE SOCKET (option)**  
Connect the headphone plug to this socket.
8. **EYE (option)**  
adjusts picture according to the surrounding conditions.

### RF/RT-21FB35 series

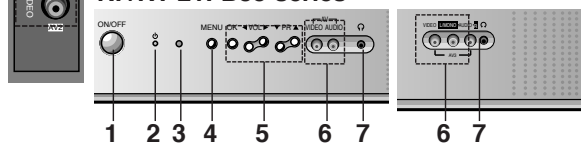

- Note :**
- a. Do not place any heavy objects (over 4Kg) on the RF/RT-21FA35 series models.
  - b. Shown is a simplified representation of front or side panel. Here shown may be somewhat different from your set.

### RF/RT-15/21FB95 series

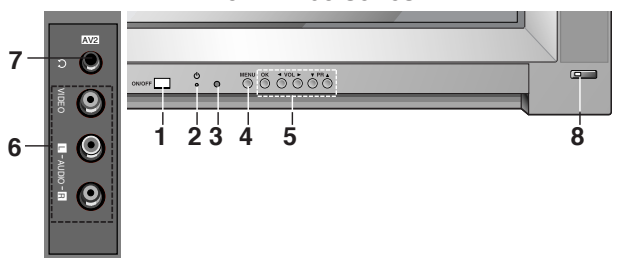

# SPECIFICATIONS

**Note :** Specification and others are subject to change without notice for improvement.

## ■ Scope

This specification can be applied to all the television related to MC-049B Chassis.

## ■ Test and Inspection Method

- 1) Capacity : Follow LG electronics TV testing Standard.
- 2) Another Required Standard
  - EMI : Following CE Standard (EN55020, EN55013)
  - Safety : Following CB Standard (EN55013)

## ■ Requirement for Test

Testing for standard of each par must be followed in below condition

- 1) Temperature :  $20 \pm 5^{\circ}\text{C}$   
(CST must be tested  $40 \pm 5^{\circ}\text{C}$  . Humidity : 50%)
- 2) Relative Humidity :  $65 \pm 10\%$
- 3) Power : Standard input Voltage (110-240V~, 50/60Hz)
- 4) Measurement must be performed after heat-run more than 20min.
- 5) Adjusting Standard for this chassis is followed a special standard.

## ■ General Specification

| No | Item                  | Specification  | Remark                 |
|----|-----------------------|--|------------------------|
| 1  | Receiving System      | 1) PAL/SECAM BG<br>2) PAL/SECAM DK<br>3) PAL I/I<br>4) NTSC M<br>5) SECAM-L/L'<br>6) NTSC 4.43(AV) | For EU/ For Non EU     |
| 2  | Receiving Channel     | 1) VHF : E2 ~ E12<br>UHF : E21 ~ E69<br>CATV : S1 ~ S20<br>HYPER : S21 ~ S41<br>2) L/L' : B,C,D    | For EU/ For Non EU     |
|    |                       | 3) VHF : 02 ~ 13<br>UHF : 14~ 69<br>CATV : 02 ~ 71   | NTSC-M (Multi - model) |
| 3  | Input Voltage         | 110-240V~, 50/60Hz   | Non EU                 |
|    |                       | 240V~, 50Hz  | EU                     |
| 4  | Market                | EU,CIS, China, Asia, Africa  |                        |
| 5  | Screen Size           | 14" ~ 21"  | FLAT / CONVENTIONAL    |
| 6  | Tuning System         | FVS 100Program   |                        |
| 7  | Operating Environment | 1) Temp. : 0 ~ 45 deg  | 200 PR. (OPTION)       |
|    |                       | 2) Humidity: 85% under   |                        |
| 8  | Storage Environment   | 1) Temp. : -20 ~ 60 deg  |                        |
|    |                       | 2) Humidity: 85% under   |                        |

# ADJUSTMENT INSTRUCTIONS

## 1. Application Object

These instructions are applied to all of the color TV, MC-049B.

## 2. Notes

- (1) Because this is not a hot chassis, it is not necessary to use an isolation transformer. However, the use of isolation transformer will help protect test instrument.
- (2) Adjustment must be done in the correct order. But the adjustment can be changed by consideration of mass production.
- (3) The adjustment must be performed in the circumstance of  $25 \pm 5^\circ\text{C}$  of temperature and  $65 \pm 10\%$  of relative humidity if there is no specific designation.
- (4) The input AC voltage of the receiver must keep rating voltage in adjusting.
- (5) The receiver must be operated for about 15 minutes prior to the adjustment.

## 3. Focus adjustment

### 3.1. Preliminary steps

Tune the TV set to receive a digital pattern.  
(SVC mode: Automatically mode change the STANDARD MODE)

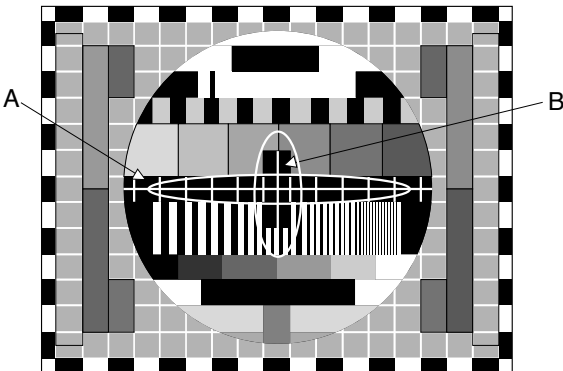

<Fig 1. PAL Digital Pattern(EU05CH)>

### 3.2. Adjustment Method

#### 1) Single Focus CPT

Adjust the upper Focus volume of FBT for the best focus of horizontal line A, vertical line B.

## 4. Purity & Convergence adjustment

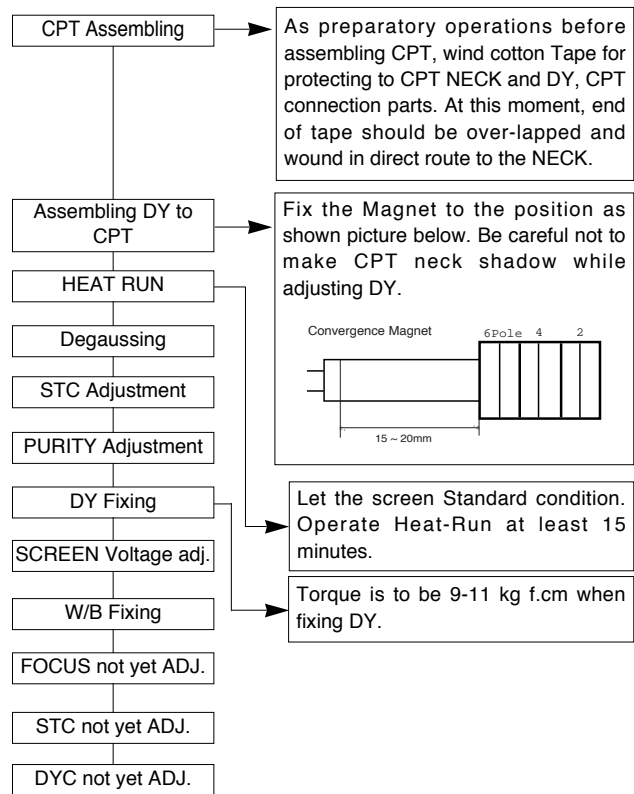

### 4.1. Color purity adjustment

- (1) It makes CPT enough to demagnetization.
- (2) Receive the signal of red raster.
- (3) Loosen fixed screw of DY and closely to CPT funnel part.
- (4) Check the center of screen that PURITY MAGNET of CPT by crossing adjustment. At this time, 4 & 6 pole magnet is located to magnet of nothing.
- (5) Move the DY to make equal red on whole screen and it does not to make the DY by fixed screw after check a simple color of Red/Green/Blue and white raster whether or not it is a pollution of color.  
(At this time, take care raster of screen and DY must fixing in the condition which maintains a horizontality.)
- (6) Check the receiver by move direction. When adjustment is not working, adjust with the assisted MAGNET.

### 4.2. Convergence adjustment

These adjustments can the best condition of focus after finished purity adjustment.

- (1) Receive the signal of CROSS HATCH that BACK RASTER is black.
- (2) Adjust brightness and luminosity till dot appear 9 ~ 12.
- (3) Open angle of the two tab of 4 pole MAGNET by isogonic angle and accord with vertical line of red and blue color in the middle of screen.



- (4) Maintain as angle of (3) and rotate the tab to accord with vertical line of Red and Blue color in the middle of screen.
- (5) Open angle of the two tab of 6 pole magnet by isogonic angle and accord with vertical line of Red/Blue and Green.
- (6) Maintain as angle of (5) and rotate the tab to accord with horizontal line. In case of twisted horizontal line, repeat adjustment of (3) ~ (5) remembering the movement of Red/Green/Blue color.
- (7) Move the DY to best condition of convergence and attach the CPT to a rubber-chock for fixed DY.

## 5. Screen voltage adjustment

- (1) Receive the PAL or SECAM(NTSC) signal into RF mode regardless of channel.
- (2) If you press the "ADJ" button in LINE SVC mode(IN-START button), the LINE SVC mode changes to screen adjustment mode.
- (3) Adjust the screen volume of FBT jack. When width line is seen turn the FBT screen volume at the position of disappearance it.
- (4) Press the TV/AV button to exit SVC mode.

## 6. White balance adjustment

**NOTE :** When adjusting white balance automatically, connect the adjustment JIG in SVC mode. (When pressing ,MUTE button on remote control, it changes to CPU OFF MODE and screen displays "AUTO".)

- (1) Receive 100% white pattern.
- (2) Adjust LOW Light status(4.5FL) of CUT R, CUT B at CG:60.
- (3) Adjust HIGH Light status(35FL) of WDR R, WDR B at WDR G:450.
- (4) Repeat above step (2) and (3) for the best condition each status of High Light and Low Light.

<Table 1> White Balance Color analyzer

| Menu              | EU     | N-EU    |
|-------------------|--------|---------|
| X                 | 288    | 266     |
| Y                 | 295    | 273     |
| Color Temperature | 9000°K | 13000°K |

<Table 2> White Balance Initial Data

| Menu       | Menu  | Range   | DATA |
|------------|-------|---------|------|
| LOW LIGHT  | CUT R | 0 ~ 511 | 60   |
|            | CUT G | 0 ~ 511 | 60   |
|            | CUT B | 0 ~ 511 | 60   |
| HIGH LIGHT | WDR R | 0 ~ 511 | 450  |
|            | WDR G | 0 ~ 511 | 450  |
|            | WDR B | 0 ~ 511 | 450  |

### \* Auto adjustment

<Table 3> White Balance Initial Data

1. IC

|        | Name     | Maker     | Algorithm |   |   |
|--------|----------|-----------|-----------|---|---|
| VCD IC | VCT49xyi | Micronas  | 0         | A | 0 |
| EP_ROM | 24C16    | ST, ATMEL |           |   |   |

## 2. White balance IIC Parameter

| Program   | TWBeng_v049 | Program     | TWBeng_v049 | Speed | Delay |
|-----------|-------------|-------------|-------------|-------|-------|
| Vcd Slave | BCF0        | Eprom_Slave | AE          | 1     | 30    |

|           | R_Amp       | R_Cut       | B_Amp       | B_Cut       |
|-----------|-------------|-------------|-------------|-------------|
| Program   | TWBeng_v049 | TWBeng_v049 | TWBeng_v049 | TWBeng_v049 |
| Sub Add   | 1C8         | 1C3         | 1CA         | 1C5         |
| Start Bit | 12          | 12          | 12          | 12          |
| Stop Bit  | 4           | 4           | 4           | 4           |
| Offset    | 0           | 0           | 0           | 0           |
| Polarity  | 1           | 1           | 1           | 1           |
| EP_Rom_S  | 9091        | 8A8B        | 9495        | 8E8F        |

| Speed/ Plus | 1 | 1 | 1 | 1 |
|-------------|---|---|---|---|
|             |   |   |   |   |

### <CAUTION> W/B Program "Twbeng\_v049"

- W/B adjustment after Cutoff  
: Instart -> adj. -> mute(cutoff)-> tv/av(wb)  
Release key is EXIT key
- W/B adjustment  
: Instart -> mute(cpuoff)  
Release key is TV/AV key

## 7. Deflection setting Data Adjustment

### 7.1 Adjustment preparation

- (1) Tune the TV set to receive a Digital pattern(EU05CH).
- (2) Deflection setting data adjustment is operate by SVC communicator.
- (3) Enter the deflection adjustment mode by selection SERVICE1 on SERVICE MENU after pressing LINE SVC MODE(IN-START KEY).
- (4) Use the CH ▲, ▼ key to select adjustment item.
- (5) Use the VOL ◀, ▶ key to increase/decrease data.

### <Note>

- (1) When adjusting a deflection, adjust N50Hz of PAL signal first and adjust a deflection at Normal 60Hz(NTSC).
- (2) Adjust a deflection as shown below.  
PAL 4:3 -> NTSC 4:3
- (3) After finishing deflection adjustment, press the ENTER key to exit in adjustment mode.

\* Before adjusting the PIP P(PIP Position), store the deflection data in the EEPROM by using the "ENTER" key.

### 7.2 Adjustment

- (1) VL(Vertical Linearity) adjustment:  
Adjust the top & bottom size of inner circle to be equal.
- (2) VA (Vertical Amplitude) adjustment:  
Adjust so that the circle of a digital circle pattern should be located interval of 6~7mm from the effective screen of the CPT.
- (3) SC (S correction) adjustment:  
Adjust so that all distance between each lattice width of top/center/bottom are to be the same.

\* Setting the CPT Default(Initial data) value like that, because it is decide by CPT DY value

- (4) VS (Vertical Shift) adjustment:  
Adjust so that the geometric vertical center line is in accord with vertical center line of CPT.
- (5) HS(Horizontal Shift) adjustment:  
Adjust so that the geometric horizontal center line is in accord with horizontal center line of CPT.

<Table 4> Initial deflection setting data

| Menu | Variable range | N50Hz(PAL)<br>FLAT 21" | N60Hz(NTSC)<br>FLAT 21" |
|------|----------------|------------------------|-------------------------|
| VS   | -512~511       | 150                    | 140                     |
| VA   | -512~511       | -12                    | -12                     |
| VL   | -512~511       | 140                    | 140                     |
| SC   | -512~511       | 6                      | 6                       |
| HS   | 32~2047        | 100                    | 123                     |

## 8.OPTION Adjustment

### 8-1. Preparation for Adjustment

- 1) This option adjustment decides function in accordance with model. Press IN-START button on SVC communicator, then adjust the option at OPTION1 mode.
- 2) Mark the option adjustment data like [111,111,111,111] in BOM.

### 8-2. Adjustment Method

OPTION data input

- 1) Function : YES, No function : NO
- 2) Select each OPTION function by the CH Up/Down button and then set up each OPTION(yes or no) by the VOL Up/Down button.

### 8-3. OPTION 1

| Option | Code | Function  |
|--------|------|-----------|
| INCH   | 0    | 21A       |
|        | 1    | 21B       |
|        | 2    | 21C       |
|        | 3    | 29F/25F   |
|        | 4    | 28WF/32WF |
|        | 5    | 28N       |
|        | 6    | 34F       |
| SYS    | 7    | 29N/25N   |
|        | 0    | BG/I/DK   |
|        | 1    | BG/I/DK/L |
|        | 2    | BG/I/DK/M |
| SOUND  | 3    | BG/L      |
|        | 0    | RF STEREO |
|        | 1    | AV STEREO |
|        | 2    | MONO      |
| CH+AU  | 3    | MONO DUAL |
|        | 0    | Using     |
|        | 1    | Not using |

### 8-4. OPTION2 Function

| Option | Code | Function              |
|--------|------|-----------------------|
| AV2    | 0    | Without A/V2          |
|        | 1    | With AV2              |
| DVD    | 0    | Without DVD           |
|        | 1    | With DVD              |
| SCART1 | 0    | Without SCART1        |
|        | 1    | With SCART1           |
| GAME   | 0    | Without GAME function |
|        | 1    | With GAME function    |
| EYE    | 0    | Without EYE           |
|        | 1    | With EYE              |
| TX     | 0    | LARGE                 |
|        | 1    | SMALL                 |
| KEY    | 0    | 6,8 KEY               |
|        | 1    | 4 KEY                 |
| DEGAU  | 0    | Without DEGAU         |
|        | 1    | Whit DEGAU            |

### 8-5. OPTION3 Function

| Option | Code | Function                     |
|--------|------|------------------------------|
| TEXT   | 0    | Without TEXT (200PR)         |
|        | 1    | With TEXT (100PR)            |
| TOP    | 0    | FLOP                         |
|        | 1    | TOP                          |
| ACMS   | 0    | Without ACMS                 |
|        | 1    | With ACMS                    |
| I 2 SV | 0    | Without I 2 SV               |
|        | 1    | With I 2 SV                  |
| VOL    | 0    | VOL 0                        |
|        | 1    | VOL 1                        |
| TSEAR  | 0    | Without TURBO SEARCH         |
|        | 1    | With TURBO SEARCH            |
| T P-S  | 0    | Without TURBO PICTURE/ SOUND |
|        | 1    | With TURBO PICTURE/ SOUND    |
| HDEV   | 0    | Without HDEV                 |
|        | 1    | With HDEV                    |

## 8-6. OPTION4 Function

| Option | Code | Function        |
|--------|------|-----------------|
| OSD L  | 0    | ENG ONLY        |
|        | 1    | EU-5EA          |
|        | 2    | EU ETC          |
|        | 3    | GREECE          |
|        | 4    | EU-ALL          |
|        | 5    | FARSI           |
|        | 6    | ARAB URDU       |
|        | 7    | E+HINDI         |
|        | 8    | E+M+V           |
|        | 9    | E+THAI          |
|        | 10   | E+CHINA         |
| TXT L  | 0    | WEST EU         |
|        | 1    | EAST EU1        |
|        | 2    | TURKEY EU       |
|        | 3    | EAST EU2        |
|        | 4    | CYRILLIC1       |
|        | 5    | CYRILLIC2       |
|        | 6    | CYRILLIC3       |
|        | 7    | TURK GRE1       |
|        | 8    | TURK GRE2       |
|        | 9    | TURK GRE3       |
|        | 10   | ARAB FRA        |
|        | 11   | ARAB ENG        |
|        | 12   | ARAB HEB1       |
|        | 13   | ARAB HEB2       |
|        | 14   | FARS ENG        |
|        | 15   | FARS FA         |
|        | 16   | FARS ALL        |
| 17     | AUTO |                 |
| HOTEL  | 0    | WITHOUT HDEV    |
|        | 1    | WITH HDEV       |
| MAX V  | 0~   | SETTING VOL MAX |
|        | 100  |                 |

# TROUBLE SHOOTING

## RF- STEREO MODEL

### PICTURE O.K / NO SOUND

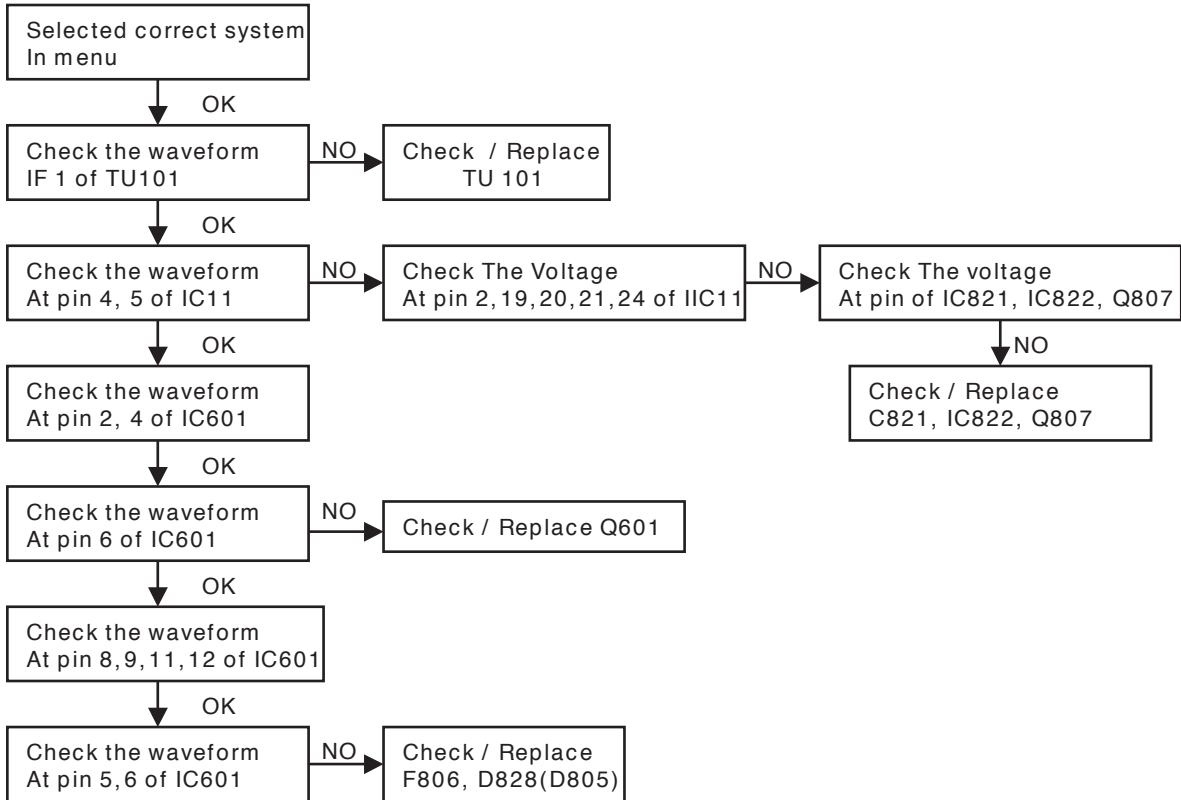

### No Raster / Sound OK (1/2)

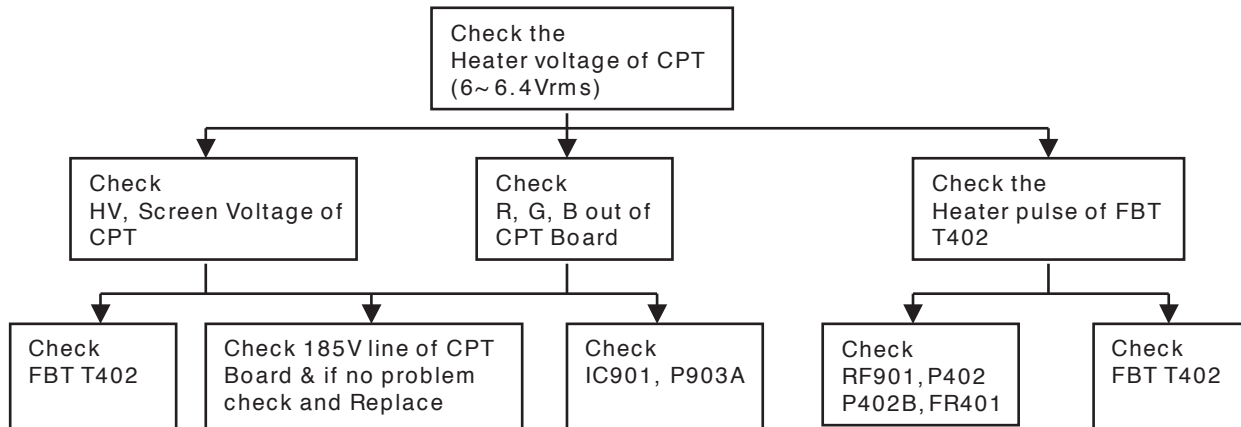

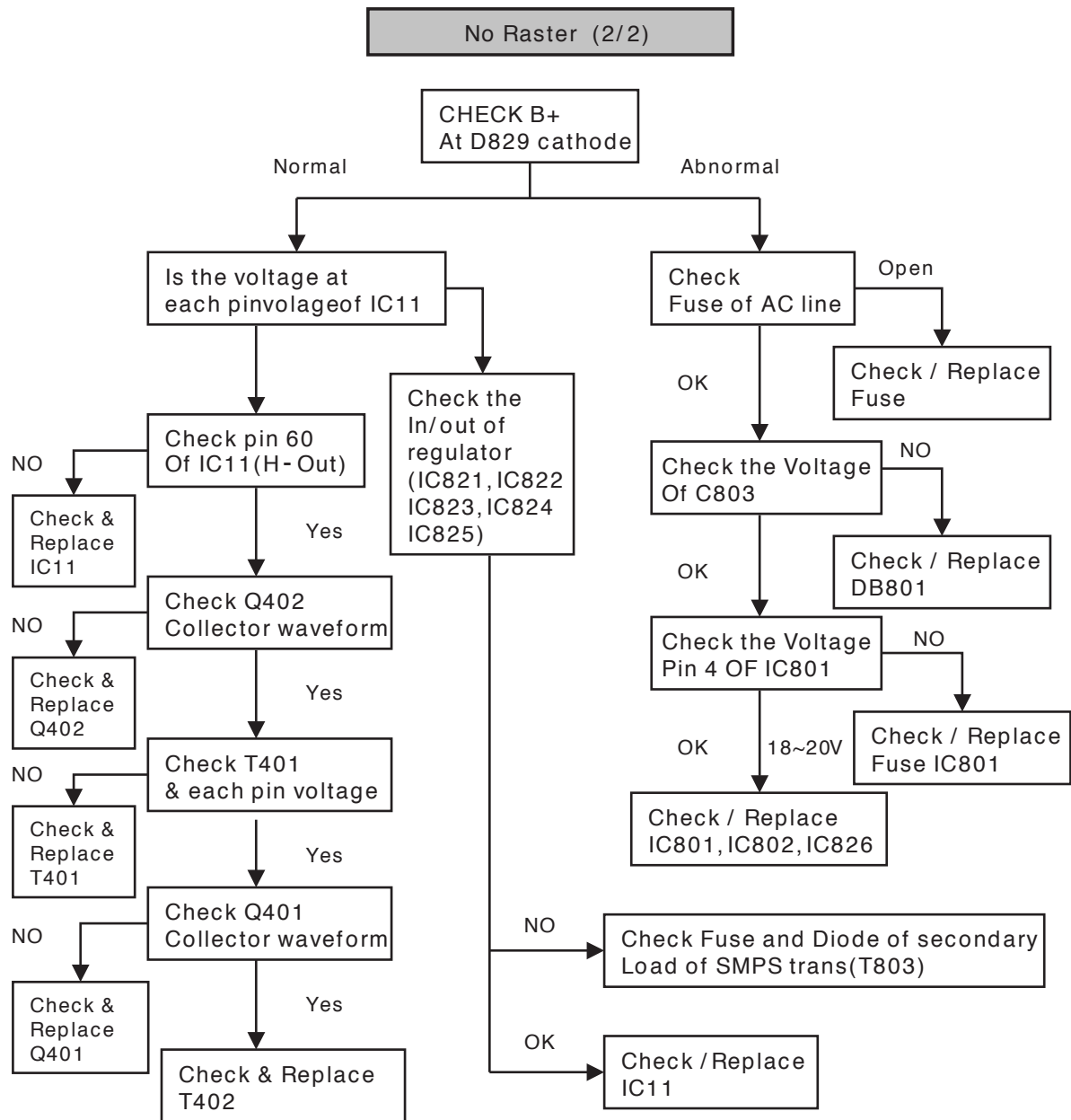

NO Picture / No Sound

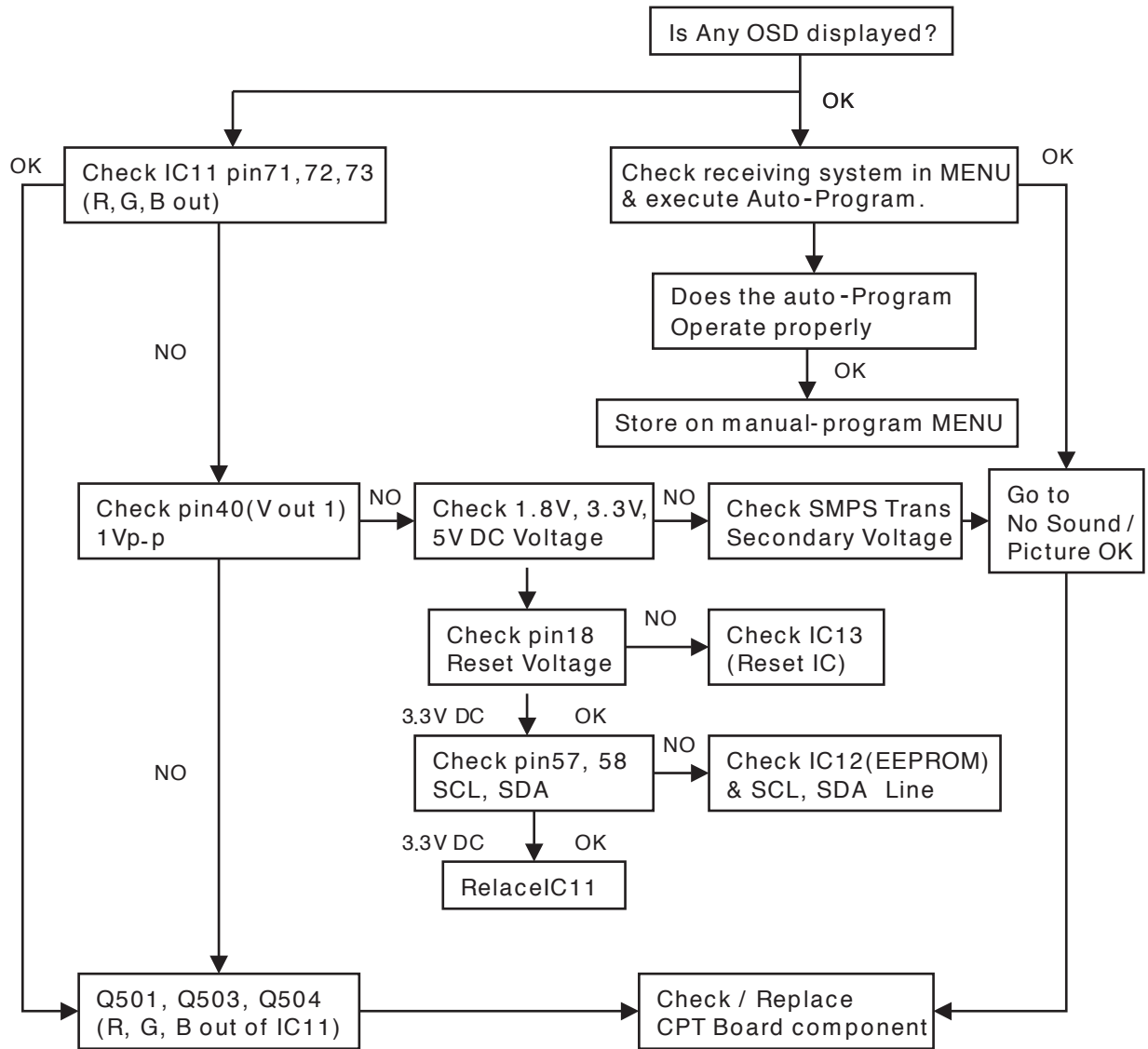

AV STERRO / MONO MODEL

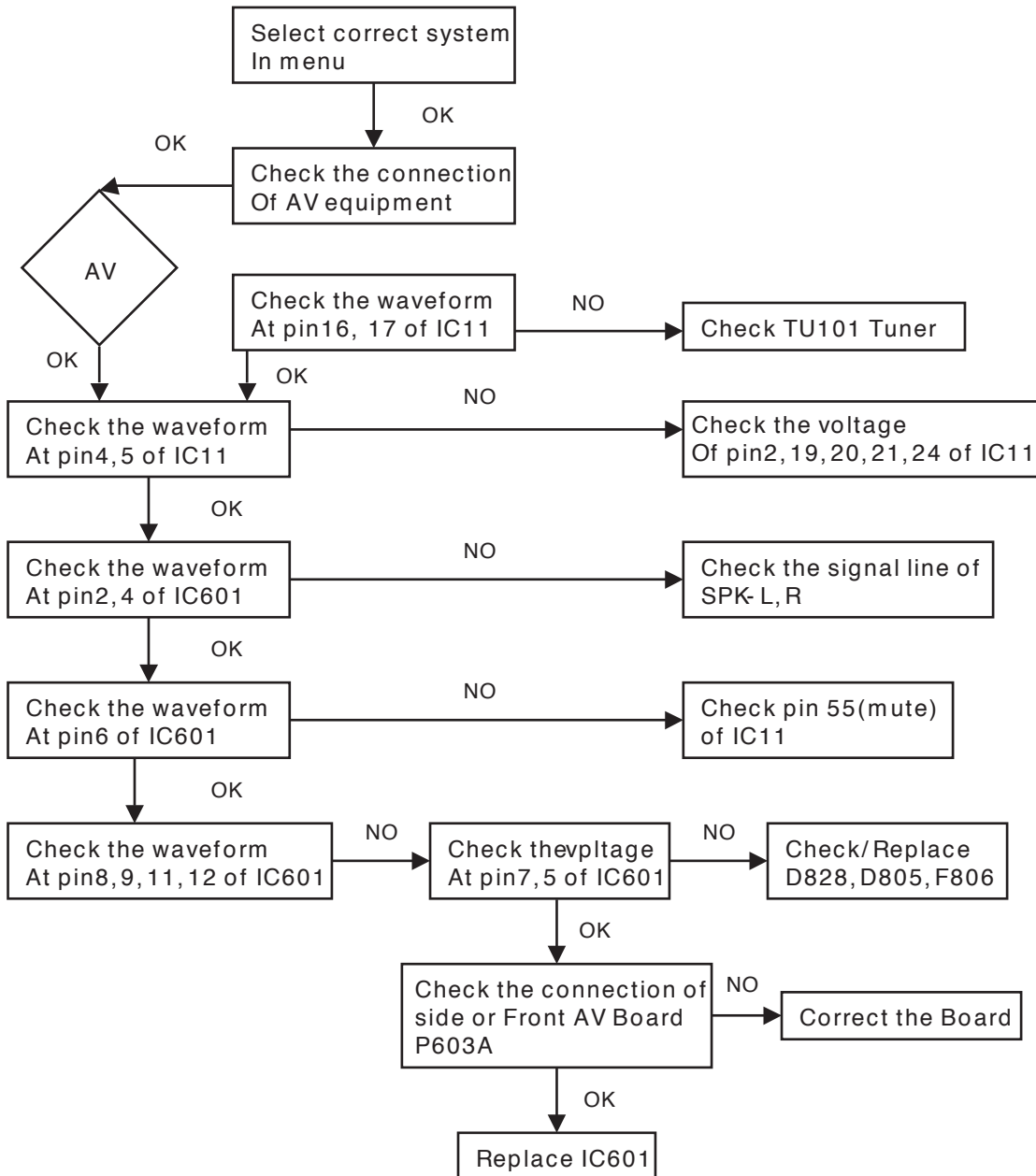

# PRINTED CIRCUIT BOARD

MAIN

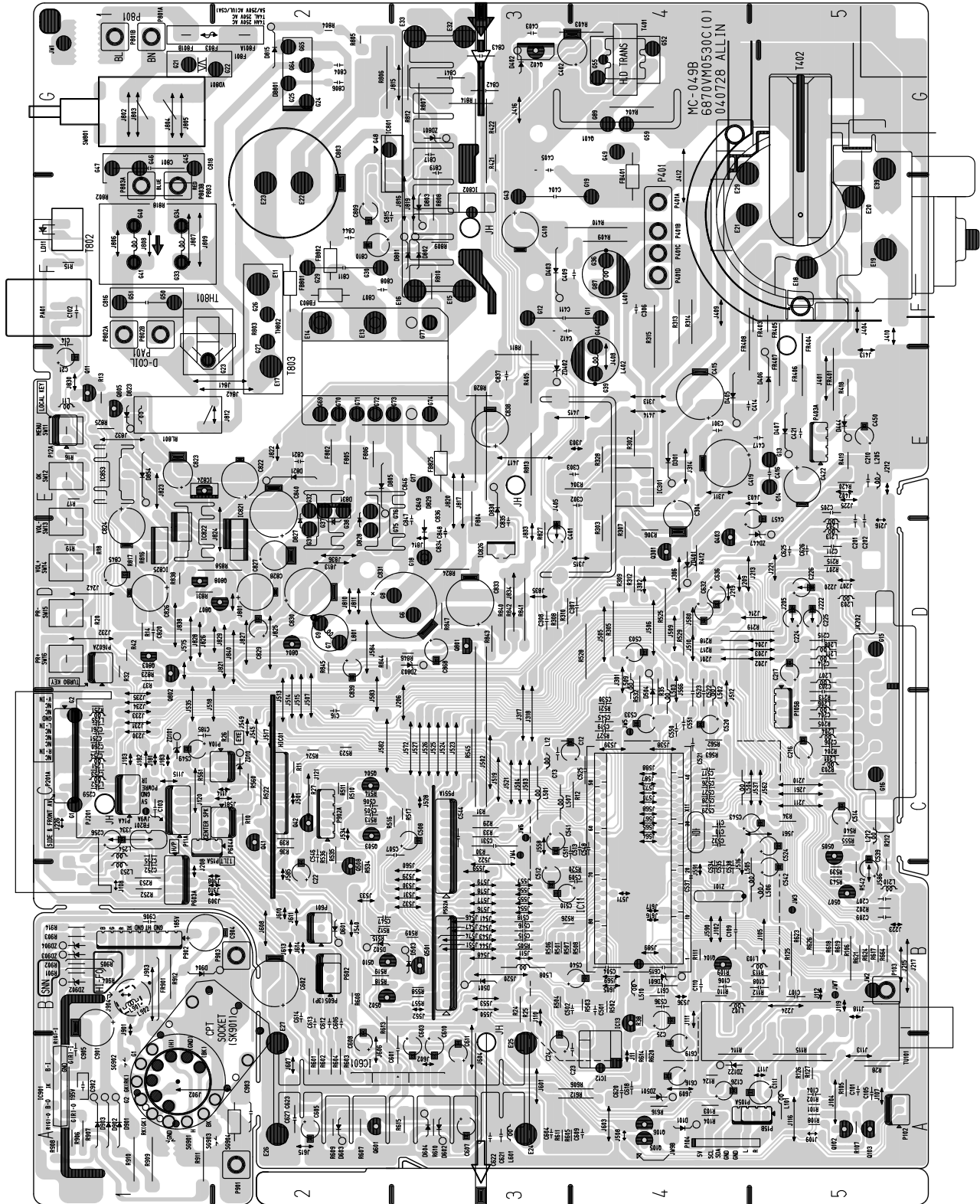



## COMPONENT LOCATION GUIDE

|             |             |             |              |             |             |              |             |             |              |
|-------------|-------------|-------------|--------------|-------------|-------------|--------------|-------------|-------------|--------------|
| C10.....C4  | C501.....B4 | C626.....D5 | D823.....E1  | J231.....C1 | J541.....B3 | J810.....D2  | R19.....D1  | R421.....F3 | R805.....G2  |
| C11.....C4  | C502.....B4 | C627.....A2 | D827.....D2  | J232.....D1 | J542.....B3 | J811.....D2  | R20.....D1  | R422.....G3 | R806.....G3  |
| C12.....C4  | C503.....D4 | C632.....D4 | D828.....D2  | J233.....C1 | J543.....B3 | J812.....E2  | R24.....B3  | R501.....B3 | R807.....G3  |
| C13.....C3  | C504.....B4 | C636.....D4 | D829.....D3  | J234.....C1 | J544.....B3 | J813.....D2  | R25.....B3  | R502.....B4 | R808.....F3  |
| C14.....F1  | C505.....C3 | C801.....G1 | D830.....E3  | J235.....C1 | J545.....C2 | J814.....D3  | R26.....C2  | R503.....B4 | R809.....F3  |
| C16.....C2  | C506.....C3 | C803.....F2 | D854.....E1  | J242.....D1 | J546.....B3 | J815.....G3  | R27.....C2  | R504.....B3 | R810.....F3  |
| C21.....E1  | C507.....C3 | C804.....G2 | D901.....A1  | J261.....C5 | J547.....B3 | J816.....F3  | R28.....A5  | R505.....B3 | R811.....E3  |
| C22.....B2  | C508.....C3 | C806.....G2 | D902.....A1  | J301.....C4 | J548.....B3 | J817.....D3  | R29.....C3  | R506.....B3 | R812.....G3  |
| C23.....A4  | C509.....B4 | C807.....F3 | D903.....A1  | J302.....D4 | J549.....C2 | J819.....F3  | R30.....C3  | R507.....B4 | R813.....E3  |
| C24.....A3  | C510.....B3 | C808.....F3 | D904.....B2  | J303.....E4 | J550.....B3 | J820.....D3  | R31.....C3  | R508.....B4 | R814.....G3  |
| C25.....B4  | C511.....C4 | C809.....F2 | DB801.....G2 | J306.....D4 | J551.....B3 | J821.....D2  | R32.....D1  | R509.....B3 | R816.....D1  |
| C101.....A5 | C512.....B3 | C810.....F2 | HIC01.....C2 | J308.....B2 | J552.....B3 | J822.....E2  | R33.....C3  | R510.....C2 | R817.....D1  |
| C102.....F1 | C513.....C4 | C811.....F2 | IC11.....B4  | J309.....B2 | J553.....B3 | J823.....E1  | R34.....C5  | R511.....C2 | R818.....F1  |
| C103.....C1 | C514.....C5 | C815.....F3 | IC12.....A4  | J310.....B2 | J554.....B3 | J824.....D2  | R35.....C4  | R512.....B3 | R823.....D1  |
| C104.....A5 | C515.....B3 | C816.....F1 | IC13.....B4  | J311.....E4 | J555.....B3 | J825.....D2  | R36.....C2  | R513.....C3 | R824.....D3  |
| C105.....A5 | C516.....B3 | C817.....G3 | IC301.....E4 | J313.....E4 | J556.....B3 | J826.....D2  | R37.....D2  | R514.....C3 | R825.....E1  |
| C106.....B4 | C517.....C4 | C818.....G1 | IC601.....A3 | J314.....E4 | J557.....B3 | J827.....D2  | R38.....B4  | R515.....B3 | R827.....D3  |
| C107.....B5 | C518.....B3 | C819.....G3 | IC801.....G2 | J315.....D4 | J558.....C3 | J828.....D1  | R39.....C2  | R516.....C3 | R828.....E3  |
| C108.....B5 | C519.....C4 | C820.....D1 | IC802.....F3 | J317.....E3 | J559.....B3 | J829.....D2  | R42.....D1  | R517.....C3 | R831.....D2  |
| C109.....B4 | C520.....C4 | C821.....E2 | IC821.....D2 | J318.....C3 | J560.....B3 | J830.....E1  | R101.....A5 | R518.....B3 | R838.....D1  |
| C110.....B4 | C521.....C4 | C822.....E2 | IC822.....E1 | J334.....C1 | J561.....C5 | J832.....E1  | R102.....A5 | R519.....B3 | R840.....D3  |
| C111.....A5 | C522.....C4 | C823.....E1 | IC824.....E1 | J401.....E5 | J562.....C5 | J833.....D3  | R103.....A4 | R520.....B4 | R841.....D3  |
| C126.....A4 | C523.....C4 | C824.....D1 | IC825.....D1 | J402.....E5 | J564.....C4 | J834.....D3  | R104.....A4 | R521.....C4 | R842.....D3  |
| C185.....C1 | C524.....C5 | C826.....D1 | IC826.....D3 | J403.....E5 | J565.....C4 | J835.....D3  | R105.....A5 | R522.....C2 | R843.....D3  |
| C201.....D5 | C525.....C4 | C827.....D2 | IC853.....E1 | J404.....F5 | J566.....C4 | J836.....D2  | R106.....B5 | R523.....C2 | R844.....D3  |
| C202.....D5 | C526.....C4 | C828.....D2 | IC901.....A1 | J405.....D3 | J567.....C4 | J838.....D1  | R107.....A5 | R524.....C2 | R845.....D2  |
| C203.....C5 | C527.....C4 | C829.....D2 | J11.....A4   | J408.....E4 | J568.....C4 | J840.....D2  | R108.....A5 | R525.....D4 | R846.....D3  |
| C204.....C5 | C528.....C4 | C830.....D2 | J102.....B4  | J409.....F4 | J569.....B4 | J841.....E2  | R109.....B4 | R526.....B4 | R847.....D3  |
| C205.....E5 | C529.....C4 | C831.....D3 | J103.....C1  | J410.....F5 | J570.....C4 | J842.....E2  | R110.....B4 | R527.....C4 | R858.....D1  |
| C206.....C5 | C530.....C4 | C833.....D3 | J104.....A5  | J412.....F4 | J571.....B4 | J901.....A1  | R111.....B4 | R528.....D4 | R901.....B1  |
| C207.....B5 | C531.....C3 | C834.....D3 | J105.....B5  | J413.....E5 | J572.....C3 | J902.....A2  | R112.....B5 | R529.....D4 | R902.....B1  |
| C209.....B5 | C532.....C4 | C835.....E3 | J107.....A5  | J414.....E4 | J573.....C4 | J903.....B1  | R113.....B5 | R532.....C4 | R903.....B1  |
| C210.....E5 | C533.....C4 | C836.....E3 | J108.....B1  | J415.....E3 | J574.....B3 | J904.....B1  | R114.....A5 | R534.....B2 | R904.....B1  |
| C211.....D5 | C534.....B4 | C837.....E3 | J109.....A5  | J416.....G3 | J575.....D1 | JK202.....C5 | R115.....A5 | R535.....B2 | R905.....B1  |
| C214.....D5 | C535.....B4 | C838.....E3 | J110.....B3  | J417.....E3 | J576.....B3 | JP1.....G2   | R124.....A4 | R536.....B2 | R906.....A1  |
| C215.....D5 | C536.....B4 | C839.....D2 | J111.....B4  | J501.....C2 | J577.....B3 | JP2.....F2   | R125.....B5 | R539.....B5 | R907.....A1  |
| C216.....C5 | C537.....B4 | C840.....E2 | J112.....B5  | J502.....C3 | J578.....B3 | JW1.....G1   | R126.....A5 | R540.....C5 | R908.....A1  |
| C217.....D5 | C538.....B4 | C841.....G3 | J113.....A5  | J503.....C3 | J579.....B3 | JW2.....B5   | R127.....A5 | R542.....C5 | R909.....A1  |
| C224.....D5 | C539.....C5 | C842.....G3 | J114.....C2  | J504.....C3 | J580.....D4 | Q11.....E1   | R202.....B5 | R543.....B5 | R910.....A1  |
| C225.....D5 | C540.....B4 | C843.....G3 | J115.....C1  | J505.....D4 | J581.....C2 | Q41.....C2   | R203.....C5 | R545.....C3 | R911.....A2  |
| C226.....D5 | C541.....C3 | C844.....F2 | J116.....A5  | J506.....D4 | J582.....C3 | Q42.....C2   | R204.....C5 | R555.....C5 | R912.....B1  |
| C251.....C1 | C542.....B5 | C845.....D1 | J117.....A5  | J507.....C2 | J583.....D2 | Q102.....A5  | R205.....C5 | R557.....B3 | R914.....B1  |
| C252.....B1 | C543.....C5 | C846.....E3 | J118.....B5  | J508.....A4 | J584.....D2 | Q103.....A5  | R207.....D5 | R558.....B3 | RL801.....E1 |
| C253.....C1 | C544.....C3 | C847.....D3 | J119.....B5  | J509.....D4 | J585.....B2 | Q104.....B4  | R212.....C5 | R560.....C2 | T401.....G4  |
| C254.....C1 | C545.....C4 | C848.....D3 | J120.....C1  | J510.....D4 | J586.....C5 | Q105.....A4  | R213.....C5 | R561.....C2 | T402.....F5  |
| C255.....C1 | C546.....B2 | C849.....D3 | J121.....C2  | J511.....B3 | J587.....C4 | Q106.....A4  | R215.....D5 | R562.....C4 | T802.....F1  |
| C256.....C1 | C547.....B2 | C868.....D3 | J181.....C1  | J512.....C4 | J588.....C4 | Q301.....D4  | R217.....D5 | R563.....C4 | T803.....F3  |
| C259.....C1 | C548.....C4 | C901.....B1 | J182.....C1  | J513.....C2 | J589.....B4 | Q401.....G4  | R218.....D5 | R601.....A2 | TH801.....F1 |
| C260.....C1 | C549.....C1 | C902.....A1 | J183.....C1  | J514.....C2 | J590.....B4 | Q402.....G3  | R219.....D5 | R602.....A2 | TH802.....F2 |
| C261.....C1 | C550.....C4 | C903.....A2 | J201.....D5  | J515.....C2 | J591.....C4 | Q403.....D4  | R251.....C1 | R603.....A2 | TU101.....B5 |
| C301.....E4 | C551.....C4 | C904.....B2 | J202.....D5  | J516.....B4 | J601.....A3 | Q501.....B3  | R252.....B1 | R604.....A2 | VD801.....G1 |
| C302.....E4 | C601.....A3 | C905.....A1 | J203.....D5  | J517.....C2 | J602.....A3 | Q502.....B2  | R253.....B1 | R605.....A4 | X11.....C4   |
| C303.....E4 | C602.....B2 | C906.....B1 | J204.....D5  | J518.....C2 | J603.....A4 | Q503.....C2  | R302.....E4 | R606.....A4 | Z101.....B4  |
| C304.....D4 | C603.....A3 | D101.....A4 | J205.....D5  | J519.....C3 | J604.....A3 | Q504.....C2  | R303.....D4 | R607.....A2 | ZD10.....C2  |
| C306.....F4 | C604.....A3 | D301.....E4 | J206.....C3  | J520.....B3 | J605.....B4 | Q505.....C5  | R304.....E4 | R608.....B2 | ZD101.....C1 |
| C307.....D4 | C605.....A2 | D402.....G3 | J207.....D5  | J521.....C3 | J606.....A2 | Q507.....B5  | R305.....D4 | R609.....A2 | ZD122.....A4 |
| C308.....D3 | C606.....B2 | D403.....F3 | J208.....C1  | J522.....B3 | J607.....A2 | Q508.....B2  | R306.....D4 | R610.....A3 | ZD401.....D4 |
| C401.....D3 | C607.....A3 | D405.....E4 | J209.....D4  | J523.....C3 | J608.....B2 | Q510.....B2  | R307.....D4 | R611.....A3 | ZD402.....E3 |
| C402.....G4 | C608.....B2 | D406.....E5 | J210.....C5  | J524.....C3 | J609.....A4 | Q601.....A2  | R308.....D3 | R612.....A4 | ZD447.....D5 |
| C403.....G3 | C609.....A4 | D407.....E5 | J211.....C5  | J525.....C3 | J610.....B2 | Q801.....D3  | R309.....D4 | R613.....B3 | ZD501.....A4 |
| C404.....F3 | C610.....A3 | D444.....E5 | J212.....E5  | J526.....C3 | J611.....B2 | Q802.....D1  | R310.....D4 | R614.....A4 | ZD601.....B4 |
| C405.....G3 | C611.....A3 | D501.....B3 | J213.....D5  | J527.....C3 | J613.....B2 | Q803.....D1  | R312.....D4 | R615.....A3 | ZD801.....G3 |
| C409.....F4 | C612.....B2 | D502.....B2 | J214.....D5  | J528.....C3 | J614.....B2 | Q804.....D2  | R313.....F4 | R616.....A4 | ZD803.....D3 |
| C410.....F3 | C613.....B2 | D503.....B3 | J215.....B5  | J529.....B3 | J615.....A2 | Q805.....E1  | R314.....F4 | R617.....B5 | ZD902.....B1 |
| C411.....F3 | C614.....B2 | D504.....D4 | J216.....D5  | J530.....B3 | J616.....B4 | Q807.....D2  | R315.....F4 | R618.....B5 | ZD903.....B1 |
| C412.....F4 | C615.....B4 | D601.....B2 | J217.....B5  | J531.....B3 | J617.....B4 | Q808.....D2  | R328.....E4 | R619.....B5 | ZD904.....B1 |
| C414.....E5 | C616.....A4 | D602.....A3 | J219.....D4  | J532.....B3 | J801.....D2 | R10.....C2   | R403.....G4 | R620.....A4 |              |
| C415.....E4 | C617.....B4 | D603.....A2 | J220.....D5  | J533.....B2 | J802.....D1 | R11.....C2   | R404.....G4 | R621.....B5 |              |
| C416.....E5 | C618.....A4 | D604.....A3 | J221.....D5  | J534.....C2 | J803.....G1 | R12.....C4   | R405.....F3 | R623.....B5 |              |
| C417.....E5 | C619.....A4 | D801.....F3 | J222.....D5  | J535.....C1 | J804.....G1 | R13.....E1   | R409.....F4 | R624.....B5 |              |
| C419.....E4 | C620.....A4 | D802.....F3 | J223.....B5  | J536.....B4 | J805.....G1 | R14.....D1   | R410.....F4 | R626.....B5 |              |
| C421.....E5 | C621.....A3 | D803.....F3 | J224.....B5  | J537.....C5 | J806.....F1 | R15.....F1   | R412.....D4 | R664.....B5 |              |
| C422.....E5 | C622.....A3 | D805.....E3 | J225.....E5  | J538.....C4 | J807.....F1 | R16.....E1   | R418.....E5 | R802.....F1 |              |
| C450.....E5 | C623.....A2 | D815.....G2 | J226.....C1  | J539.....C4 | J808.....F1 | R17.....E1   | R419.....E5 | R803.....E2 |              |
| C457.....D5 | C625.....D5 | D821.....E2 | J230.....C1  | J540.....B2 | J809.....F2 | R18.....D1   | R420.....E5 | R804.....G2 |              |

**PIP**

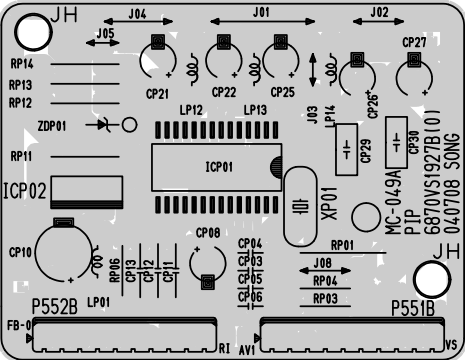

# BLOCK DIAGRAM

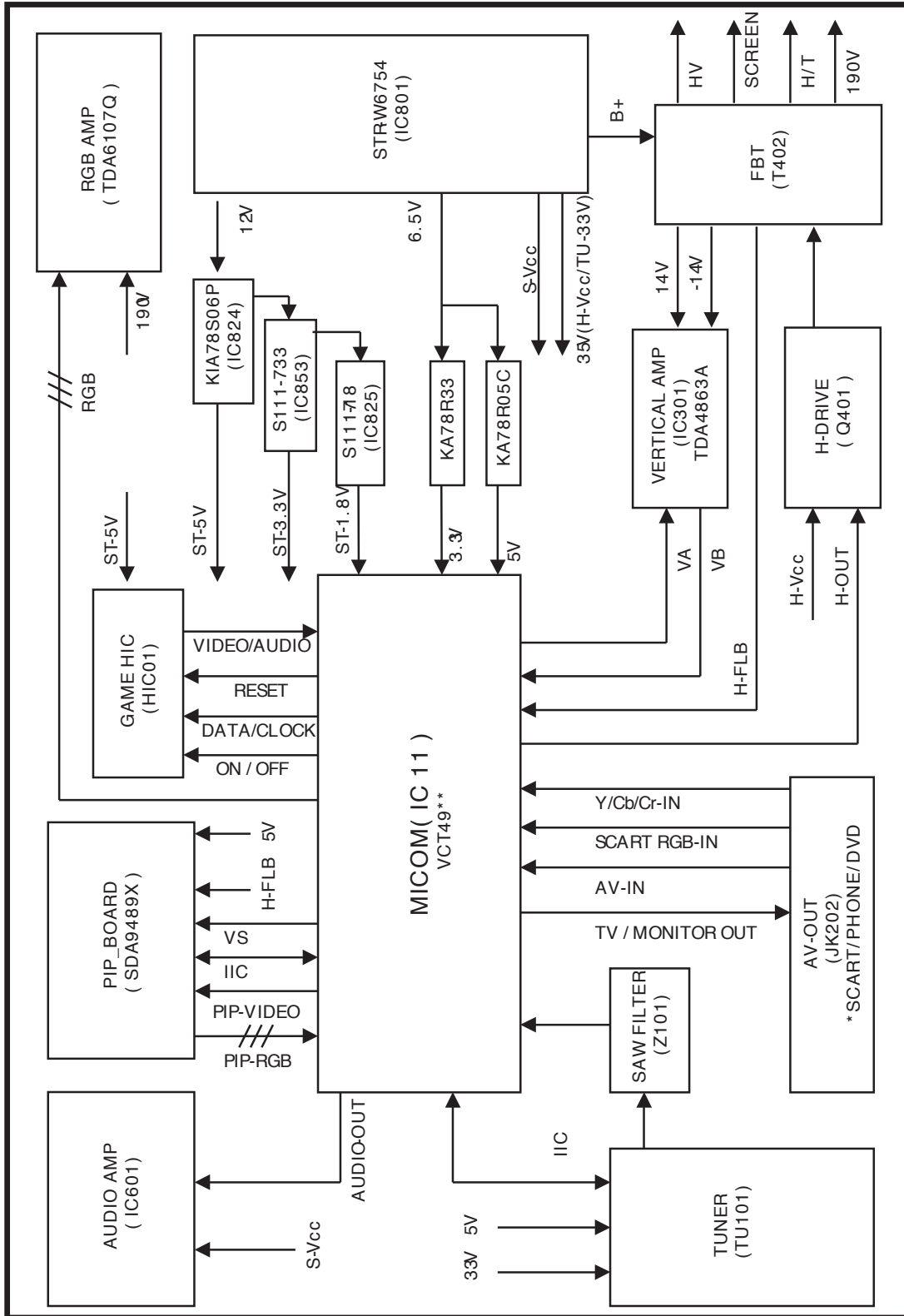

# EXPLODED VIEW

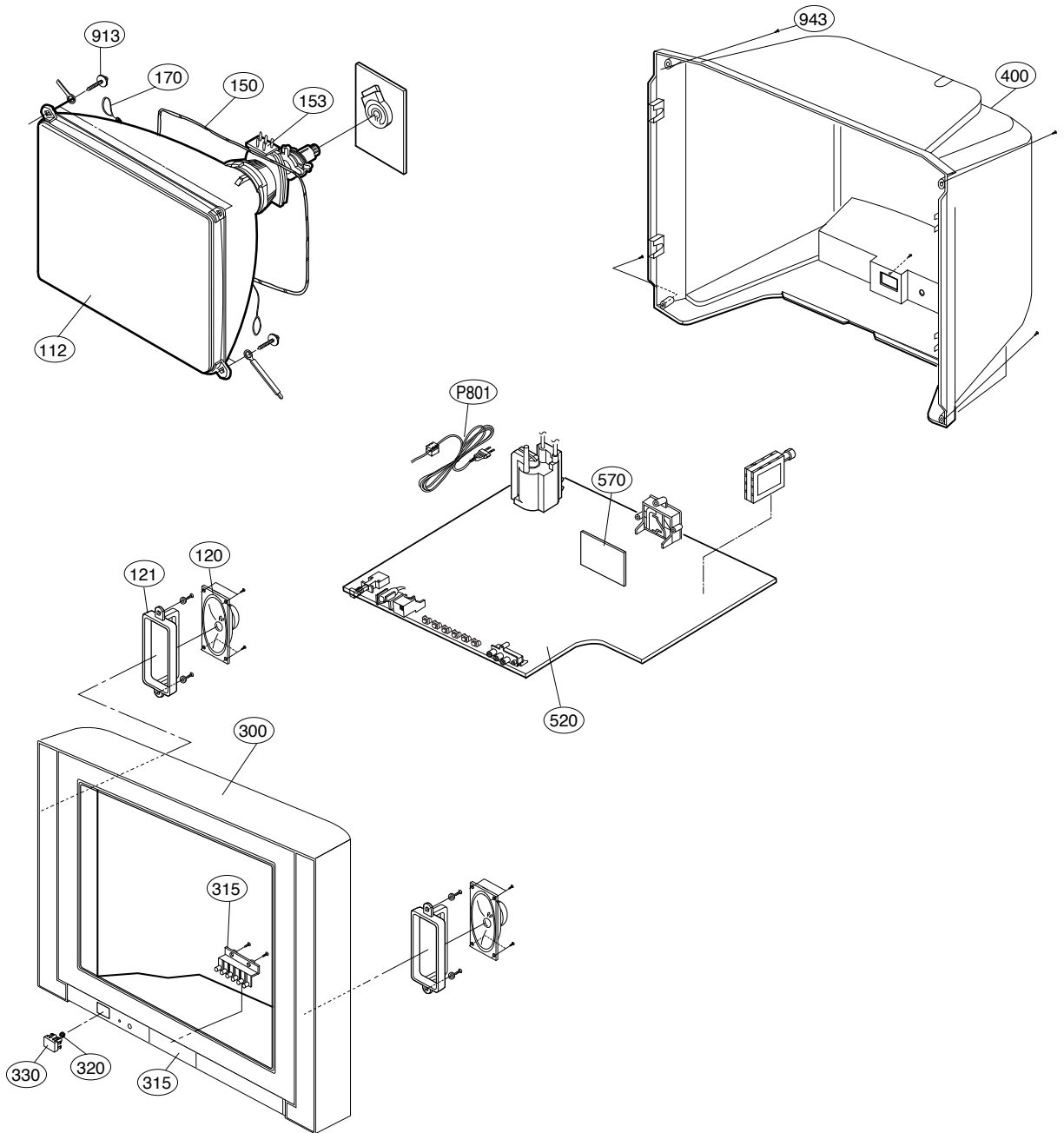

# EXPLODED VIEW PARTS LIST

The components identified by mark  $\Delta$  is critical for safety.  
Replace only with part number specified.

| LOCA. No.     | PART No.    | DESCRIPTIONS  |
|---------------|-------------|---|
| $\Delta$ 112  | 6334V21009A | CPT, A51QDJ420X 01 16KHZ BARE AK MASK (CASA-S, AMATIS)                      |
|               | 6335V21019A | CPT, A51QDJ420X 01MDDR M(+0.30G) 0G RT-21FA35V.LDLLAT7(LGEAK)               |
|               | 6341V21012A | BARE CPT ASSEMBLY, LG 21 AK CPT 6334V21009A(6150V-1014J) RT-21FA35RX.ADLLKR |
| 120           | 120-C77M    | SPEAKER,FULLRANGE C122P02K1459 ESTEC 8 OHM 10/15W 130DB 57*117MM            |
| 121           | 4810V00088A | BRACKET, SPEAKER CE-29K30   |
|               | 4810V00088B | BRACKET, SPEAKER CE-29K3  |
| $\Delta$ 150  | 150-D02N    | COIL,DEGAUSSING,CU 21" 60T 12 OHM   |
|               | 150-D02T    | COIL,DEGAUSSING,AL 21" 56T 12 OHM   |
| $\Delta$ 153  | 6150V-1014J | DY(DEFLECTION YOKE), 6150Z-1227A 21" LG SLIM                                |
| $\Delta$ 170  | 170-A01N    | CPT EARTH, 21" 64T 2LUG 1P HSG CL-21Q20ET(PC-99DA)                          |
| 300           | 3091V00335W | CABINET ASSEMBLY, RT-21FA35VX STEREO MC049B #117A MT->SET                   |
|               | 3091V00335Z | CABINET ASSEMBLY, RT-21FA35VD STEREO MC049B LGEMT-AMATIS                    |
|               | 3091V00383Q | CABINET ASSEMBLY, RT-21FA35RX STEREO MC049B                                 |
|               | 3091V00617B | CABINET ASSEMBLY, RT-21FA35V STEREO E_PHONE MC049B AK LOCAL                 |
| 310           | 5020V00501E | BUTTON, CONTROL RT-21FA35VX ABS, HF-380 6KEY MT LOCAL                       |
|               | 5020V00585C | BUTTON, CONTROL RT-21FA35RX ABS, HF-380 6KEY DDM SILVER                     |
| 315           | 3580V00064E | DOOR, CONTROL RT-21FA35VX ABS, HF-380 MT LOCAL                              |
|               | 3580V00070C | DOOR, CONTROL RT-21FA35RX ABS, HF-380 DDM SILVER                            |
| 320           | 320-062E    | SPRING, KNOB  |
| 330           | 5020V00500E | BUTTON, POWER RT-21FA35VX ABS, HF-380 1KEY MT LOCAL                         |
|               | 5020V00584C | BUTTON, POWER RT-21FA35RX ABS, HF-380 1KEY DDM SILVER                       |
| 400           | 3809V00250S | BACK COVER ASSEMBLY, RT-21FA35VX 1PHONE MT->SET                             |
|               | 3809V00250U | BACK COVER ASSEMBLY, RT-21FA35VX DVD(1PHONE) 8G068 MT-SET                   |
|               | 3809V00277K | BACK COVER ASSEMBLY, RT-21FA35RX DVD(1PHONE) 049B(85061)                    |
|               | 3809V00423B | BACK COVER ASSEMBLY, RT-21FA35V DVD(1PHONE) MC049B(AK LOCAL)                |
| 520           | 6871VMM894A | PWB(PCB) ASSEMBLY,MAIN MC049B RT-21FA35RX.ADSLKR                            |
|               | 6871VMM897A | PWB(PCB) ASSEMBLY,MAIN MC049B (MODULE)LGEMT                                 |
|               | 6871VMM897J | PWB(PCB) ASSEMBLY,MAIN MC049B RT-21FA35VD.LMLLTD7 M/I                       |
|               | 6871VMM898A | PWB(PCB) ASSEMBLY,MAIN MC049B RT-21FA35V.LDLLAT7                            |
|               | 6871VMMU15B | PWB(PCB) ASSEMBLY,MAIN MC-049B RT-21FA35VX.LMLLTD7 M/I                      |
|               | 6871VMMU15C | PWB(PCB) ASSEMBLY,MAIN MC-049B RT-21FA35R.LTLLTA7 M/I                       |
| 570           | 6871VSMK09A | PWB(PCB) ASSEMBLY,SUB PIP MC049B LGEMT-7                                    |
| 913           | 332-057B    | SCREW,DRAWING ASSY,HEXAGON HEAD   |
| 943           | 1PTF0403116 | SCREW TAP TITE(P),TRUSS HEAD + D4.0 L16.0 MSWR3/FZB                         |
| $\Delta$ P801 | 174-009E    | POWER CORD, POWER(W/HOLD,HOUSING,L=200,4.0                                  |
|               | 6410VEH001J | POWER CORD, EL-207 CHING CHENG VDE/SEMKO 2100MM HOUSING L1=200 BLACK        |

# REPLACEMENT PARTS LIST

|   |   |  |
|---|---|--|
| For Capacitor & Resistors, the characters at 2nd and 3rd digit in the P/No. means as follows; | CC, CX, CK, CN : Ceramic<br>CQ : Polyester<br>CE : Electrolytic | RD : Carbon Film<br>RS : Metal Oxide Film<br>RN : Metal Film<br>RF : Fusible |
|---|---|--|

| LOCA. NO          | PART NO     | DESCRIPTION                                |
|-------------------|-------------|--|
| <b>IC</b>         |             |  |
| IC11              | 0IMCRMN026A | VCT4973F88P PSSDIP ST FLASH                |
| IC11              | 0IMCRMN026A | VCT4973F88P PSSDIP ST FLASH                |
| IC12              | 0IMMRSG036C | M24C16-WBN6 8PIN PDIP ST 16M               |
| IC13              | 0IFA752700A | KA75270Z 3 TP RE-SET IC MC-007             |
| IC301             | 0IPMGPH002A | TDA4863A 7P SOT524-1 ST                    |
| IC601             | 0IPMGSA021C | LA42152 13P ST 15W                         |
| IC801             | 0IPMGSK016B | STR-W6754 SANKEN 7PIN TO220F ST            |
| IC802             | 0IL1817000G | LTV817M-VB 4P,DIP BK                       |
| IC821             | 0IMCRKE019A | KIA78R33API KEC 4P TO220 ST 3.3V 1A        |
| IC822             | 0IMCRKE018A | KIA78R05API KEC 4P TO220 ST 5V 1A          |
| IC824             | 0IMCRKE020A | KIA78S06P KEC 3P TO-92 TP 6V 0.15A         |
| IC825             | 0IMCRAU003A | S1117-18PIC 3P TO220F ST 1.8V 1A           |
| IC826             | 0ISK110000A | SE110N(LF12) 3P 110V ERROR AMP             |
| IC853             | 0IMCRAU004A | S1117-33PIC 3P TO220F ST 3.3V 1A           |
| IC901             | 0IPH610700B | TDA6107JF/N3 9P ST RGB AMP                 |
| <b>TRANSISTOR</b> |             |  |
| Q104              | 0TR319709AB | KTC3197,TP(KTC388A),KEC                    |
| Q11               | 0TR126609AA | KTA1266-Y(KTA1015) KEC TP TO92 50V 150MA   |
| Q301              | 0TR198009BA | 2SA1980Y TP AUK                            |
| Q401              | 0TRSA10004A | TT2170LS-YB11 ST TO-220FM 1500V 5A         |
| Q402              | 0TR233109AA | KSC2331-Y TP SAMSUNG TO-92L -              |
| Q501              | 0TR198009BA | 2SA1980Y TP AUK                            |
| Q502              | 0TR198009BA | 2SA1980Y TP AUK                            |
| Q503              | 0TR198009BA | 2SA1980Y TP AUK                            |
| Q504              | 0TR198009BA | 2SA1980Y TP AUK                            |
| Q505              | 0TR534309AA | 2SC5343Y TP AUK                            |
| Q507              | 0TR198009BA | 2SA1980Y TP AUK                            |
| Q508              | 0TR534309AA | 2SC5343Y TP AUK                            |
| Q510              | 0TR534309AA | 2SC5343Y TP AUK                            |
| Q601              | 0TR198009BA | 2SA1980Y TP AUK                            |
| Q802              | 0TR534309AA | 2SC5343Y TP AUK                            |
| Q803              | 0TR102009AB | KRC102M(KRC1202) KEC TP                    |
| Q807              | 0TR127409AB | KTA1274-Y TO-92L TP KEC                    |
| Q808              | 0TR102009AB | KRC102M(KRC1202) KEC TP                    |
| <b>DIODE</b>      |             |  |
| D301              | 0DD400509AA | 1N4005 TP KEC                              |
| D403              | 0DRTW00164B | RGP15J TP52 DO15 .V 1.5A 50A 250NSEC 100UA |
| D405              | 0DRTW00164B | RGP15J TP52 DO15 .V 1.5A 50A 250NSEC 100UA |
| D406              | 0DRTW00164B | RGP15J TP52 DO15 .V 1.5A 50A 250NSEC 100UA |
| D407              | 0DRTW00164A | RGP10J TP52 DO41 .V 1A 30A .SEC 5UA        |
| D501              | 0DD414809ED | 1N4148 TP GRANDE                           |
| D502              | 0DD414809ED | 1N4148 TP GRANDE                           |
| D503              | 0DD414809ED | 1N4148 TP GRANDE                           |
| D504              | 0DD414809ED | 1N4148 TP GRANDE                           |
| D601              | 0DD414809ED | 1N4148 TP GRANDE                           |

| LOCA. NO         | PART NO     | DESCRIPTION                               |
|------------------|-------------|---|
| D602             | 0DD414809ED | 1N4148 TP GRANDE                          |
| D603             | 0DD414809ED | 1N4148 TP GRANDE                          |
| D604             | 0DD414809ED | 1N4148 TP GRANDE                          |
| D801             | 0DD100009AM | EU1ZV(1) TP SANKEN                        |
| D802             | 0DD100009AM | EU1ZV(1) TP SANKEN                        |
| D803             | 0DD100009AM | EU1ZV(1) TP SANKEN                        |
| D815             | 0DD060009AC | TVR06J TP - 600V 250NSEC                  |
| D821             | 0DRTW00164A | RGP10J TP52 DO41 .V 1A 30A .SEC 5UA       |
| D827             | 0DRTW00141A | SFAF504G ST ITO220 200V 5A .A .SEC 10UA   |
| D828             | 0DRTW00141A | SFAF504G ST ITO220 200V 5A .A .SEC 10UA   |
| D829             | 0DD300009AC | RU3AMV(1) TP                              |
| D830             | 0DRTW00164A | RGP10J TP52 DO41 .V 1A 30A .SEC 5UA       |
| D854             | 0DD060009AC | TVR06J TP - 600V 250NSEC                  |
| D901             | 0DR210009AC | BAV21 TP DO35 200V 0.2A 1A 50SEC 100A     |
| D902             | 0DR210009AC | BAV21 TP DO35 200V 0.2A 1A 50SEC 100A     |
| D903             | 0DR210009AC | BAV21 TP DO35 200V 0.2A 1A 50SEC 100A     |
| D904             | 0DR140049AC | 1N4004A T-81 TP DO41 500V 1.0A 30A - 10UA |
| DB801            | 0DRTW00131A | D2SB60 ST GBL 600V 1.5A .A .SEC 10UA      |
| ZD101            | 0DZ510009BF | GDZ5.1B TP GRANDE DO34 0.5W 5.1V 0.02A    |
| ZD122            | 0DZ330009DG | GDZJ33B TP GRANDE DO34 0.5W 33.0V         |
| ZD401            | 0DZ510009BF | GDZ5.1B TP GRANDE DO34 0.5W 5.1V 0.02A    |
| ZD402            | 0DZ240009CG | MTZJ24B TP ROHM-K DO34 - 24V 5UA          |
| ZD501            | 0DZ110009AD | MTZJ11B TP ROHM-K DO34 - 11V 5UA          |
| ZD601            | 0DZ820009AH | MTZJ8.2B TP ROHM-K DO34 - 8.2V 5UA        |
| ZD801            | 0DZ620009AH | MTZJ6.2A TP ROHM-K DO34 0.5W 6.2V 150UA   |
| ZD803            | 0DZ510009BF | GDZ5.1B TP GRANDE DO34 0.5W 5.1V 0.02A    |
| <b>CAPACITOR</b> |             |   |
| C10              | 0CX2200K409 | 22P 50V J SL TA52                         |
| C101             | 0CQ2721N409 | 0.0027UF D 100V 5% PE TP5                 |
| C102             | 0CN3310K519 | 330P 50V K B TA52                         |
| C103             | 0CN1040K949 | 0.1UF D 50V 80%,-20% F(Y5V) TA52          |
| C104             | 0CN1030F679 | 10000P 16V M Y TA52                       |
| C106             | 0CN1030F679 | 10000P 16V M Y TA52                       |
| C107             | 0CN1030F679 | 10000P 16V M Y TA52                       |
| C108             | 0CN1030F679 | 10000P 16V M Y TA52                       |
| C109             | 0CN1030F679 | 10000P 16V M Y TA52                       |
| C11              | 0CX2200K409 | 22P 50V J SL TA52                         |
| C110             | 0CN1030F679 | 10000P 16V M Y TA52                       |
| C111             | 0CE227DD618 | 220UF STD 10V M FL TP5                    |
| C12              | 0CE107DD618 | 100UF STD 10V M FL TP5                    |
| C126             | 0CE475DK618 | 4.7UF STD 50V 20% FL TP 5                 |
| C13              | 0CN1040K949 | 0.1UF D 50V 80%,-20% F(Y5V) TA52          |
| C14              | 0CN1020K519 | 1000P 50V K B TA52                        |
| C185             | 0CN1040K949 | 0.1UF D 50V 80%,-20% F(Y5V) TA52          |
| C201             | 0CN1010K519 | 100P 50V K B TA52                         |
| C202             | 0CN1010K519 | 100P 50V K B TA52                         |
| C205             | 0CN4710K519 | 470P 50V K B TA52                         |
| C21              | 0CE107DD618 | 100UF STD 10V M FL TP5                    |

|   |   |  |
|---|---|--|
| For Capacitor & Resistors, the characters at 2nd and 3rd digit in the P/No. means as follows; | CC, CX, CK, CN : Ceramic<br>CQ : Polyester<br>CE : Electrolytic | RD : Carbon Film<br>RS : Metal Oxide Film<br>RN : Metal Film<br>RF : Fusible |
|---|---|--|

| LOCA. NO | PART NO     | DESCRIPTION                      |
|----------|-------------|----------------------------------|
| C211     | 0CN4710K519 | 470P 50V K B TA52                |
| C214     | 0CN4710K519 | 470P 50V K B TA52                |
| C215     | 0CN4710K519 | 470P 50V K B TA52                |
| C216     | 0CE226DF618 | 22UF STD 16V M FL TP5            |
| C217     | 0CE226DF618 | 22UF STD 16V M FL TP5            |
| C23      | 0CN1040K949 | 0.1UF D 50V 80%,-20% F(Y5V) TA52 |
| C24      | 0CE226DD618 | 22UF STD 10V 20% FL TP 5         |
| C25      | 0CE105DK618 | 1UF STD 50V M FL TP5             |
| C252     | 0CN2710K519 | 270P 50V K B TA52                |
| C253     | 0CN4710K519 | 470P 50V K B TA52                |
| C254     | 0CN1010K519 | 100P 50V K B TA52                |
| C255     | 0CN2710K519 | 270P 50V K B TA52                |
| C256     | 0CE106DH618 | 10UF STD 25V M FL TP5            |
| C259     | 0CN1010K519 | 100P 50V K B TA52                |
| C260     | 0CN4710K519 | 470P 50V K B TA52                |
| C303     | 0CQ1041N409 | 0.1000UF 100V J PE TP            |
| C304     | 0CE107DJ618 | 100UF STD 35V M FL TP5           |
| C306     | 0CQ3331N509 | 0.033UF D 100V 10% PE TP5        |
| C402     | 0CE475DK618 | 4.7UF STD 50V 20% FL TP 5        |
| C403     | 0CQ1521N509 | 0.0015UF D 100V 10% PE TP5       |
| C404     | 181-015E    | MPP 1600V 0.0068UF H             |
| C405     | 181-091Y    | R 680PF 2KV 10%,-10% R/TP TP7.5  |
| C409     | 0CK8210W515 | 820P 500V K B TS                 |
| C410     | 0CE475DP618 | 4.7UF STD 160V 20% FL TP 5       |
| C411     | 181-013P    | MPP 400V 0.33UF J                |
| C414     | 0CK2710W515 | 270P 500V K B TS                 |
| C415     | 0CE108DH618 | 1000UF STD 25V M FL TP5          |
| C416     | 181-009R    | PP 200V 0.022UF K                |
| C417     | 0CK2710W515 | 270P 500V K B TS                 |
| C419     | 0CE108DH618 | 1000UF STD 25V M FL TP5          |
| C421     | 0CK2710W515 | 270P 500V K B TS                 |
| C422     | 0CE475DR618 | 4.7UF STD 250V 20% FL TP 5       |
| C501     | 0CQ6831N509 | 0.068UF D 100V 10% PE TP5        |
| C502     | 0CQ6831N509 | 0.068UF D 100V 10% PE TP5        |
| C503     | 0CE475DK618 | 4.7UF STD 50V 20% FL TP 5        |
| C504     | 0CN1040K949 | 0.1UF D 50V 80%,-20% F(Y5V) TA52 |
| C505     | 0CN2710K519 | 270P 50V K B TA52                |
| C506     | 0CN2710K519 | 270P 50V K B TA52                |
| C507     | 0CN1040K949 | 0.1UF D 50V 80%,-20% F(Y5V) TA52 |
| C508     | 0CE107DD618 | 100UF STD 10V M FL TP5           |
| C509     | 0CN1040K949 | 0.1UF D 50V 80%,-20% F(Y5V) TA52 |
| C510     | 0CE475DK618 | 4.7UF STD 50V 20% FL TP 5        |
| C511     | 0CN1040K949 | 0.1UF D 50V 80%,-20% F(Y5V) TA52 |
| C512     | 0CE107DD618 | 100UF STD 10V M FL TP5           |
| C513     | 0CN1040K949 | 0.1UF D 50V 80%,-20% F(Y5V) TA52 |
| C514     | 0CE107DD618 | 100UF STD 10V M FL TP5           |
| C515     | 0CN1040K949 | 0.1UF D 50V 80%,-20% F(Y5V) TA52 |
| C516     | 0CN1040K949 | 0.1UF D 50V 80%,-20% F(Y5V) TA52 |
| C517     | 0CN1040K949 | 0.1UF D 50V 80%,-20% F(Y5V) TA52 |
| C518     | 0CN1040K949 | 0.1UF D 50V 80%,-20% F(Y5V) TA52 |
| C519     | 0CN1010K519 | 100P 50V K B TA52                |
| C520     | 0CE107DD618 | 100UF STD 10V M FL TP5           |

| LOCA. NO | PART NO     | DESCRIPTION                      |
|----------|-------------|----------------------------------|
| C521     | 0CN1040K949 | 0.1UF D 50V 80%,-20% F(Y5V) TA52 |
| C523     | 0CN1040K949 | 0.1UF D 50V 80%,-20% F(Y5V) TA52 |
| C524     | 0CE107DD618 | 100UF STD 10V M FL TP5           |
| C526     | 0CN1040K949 | 0.1UF D 50V 80%,-20% F(Y5V) TA52 |
| C527     | 0CN1040K949 | 0.1UF D 50V 80%,-20% F(Y5V) TA52 |
| C528     | 0CN1040K949 | 0.1UF D 50V 80%,-20% F(Y5V) TA52 |
| C529     | 0CN1040K949 | 0.1UF D 50V 80%,-20% F(Y5V) TA52 |
| C530     | 0CN1010K519 | 100P 50V K B TA52                |
| C531     | 0CX3300K409 | 33P 50V J SL TA52                |
| C532     | 0CN1040K949 | 0.1UF D 50V 80%,-20% F(Y5V) TA52 |
| C533     | 0CE107DD618 | 100UF STD 10V M FL TP5           |
| C534     | 0CN1040K949 | 0.1UF D 50V 80%,-20% F(Y5V) TA52 |
| C535     | 0CN1040K949 | 0.1UF D 50V 80%,-20% F(Y5V) TA52 |
| C536     | 0CN1040K949 | 0.1UF D 50V 80%,-20% F(Y5V) TA52 |
| C537     | 0CN1040K949 | 0.1UF D 50V 80%,-20% F(Y5V) TA52 |
| C538     | 0CN1040K949 | 0.1UF D 50V 80%,-20% F(Y5V) TA52 |
| C540     | 0CE107DD618 | 100UF STD 10V M FL TP5           |
| C541     | 0CE107DD618 | 100UF STD 10V M FL TP5           |
| C542     | 0CE107DD618 | 100UF STD 10V M FL TP5           |
| C543     | 0CE107DD618 | 100UF STD 10V M FL TP5           |
| C545     | 0CX2200K409 | 22P 50V J SL TA52                |
| C546     | 0CN1510K519 | 150P 50V K B TA52                |
| C547     | 0CN2710K519 | 270P 50V K B TA52                |
| C548     | 0CN1040K949 | 0.1UF D 50V 80%,-20% F(Y5V) TA52 |
| C550     | 0CN1040K949 | 0.1UF D 50V 80%,-20% F(Y5V) TA52 |
| C602     | 0CE108DH618 | 1000UF STD 25V M FL TP5          |
| C603     | 0CE475DK618 | 4.7UF STD 50V 20% FL TP 5        |
| C604     | 0CQ8221N519 | 0.0082UF D 100V 10% PE NI TP5    |
| C605     | 0CE476DF618 | 47UF STD 16V M FL TP5            |
| C606     | 181-007C    | MPE ECQ-V1H104JL3(TR), 50V 0.1UF |
| C607     | 0CE106DF618 | 10UF STD 16V M FL TP5            |
| C608     | 0CE106DF618 | 10UF STD 16V M FL TP5            |
| C609     | 0CQ8221N519 | 0.0082UF D 100V 10% PE NI TP5    |
| C610     | 0CE475DK618 | 4.7UF STD 50V 20% FL TP 5        |
| C611     | 0CE476DH618 | 47UF STD 25V 20% FL TP 5         |
| C612     | 181-007C    | MPE ECQ-V1H104JL3(TR), 50V 0.1UF |
| C613     | 181-007C    | MPE ECQ-V1H104JL3(TR), 50V 0.1UF |
| C614     | 181-007C    | MPE ECQ-V1H104JL3(TR), 50V 0.1UF |
| C615     | 0CN1040K949 | 0.1UF D 50V 80%,-20% F(Y5V) TA52 |
| C616     | 0CE476DD618 | 47UF STD 10V 20% FL TP 5         |
| C617     | 0CN1040K949 | 0.1UF D 50V 80%,-20% F(Y5V) TA52 |
| C618     | 0CN1010K519 | 100P 50V K B TA52                |
| C619     | 0CE335DK618 | 3.3UF STD 50V 20% FL TP 5        |
| C620     | 0CN1010K519 | 100P 50V K B TA52                |
| C625     | 0CQ3331N509 | 0.033UF D 100V 10% PE TP5        |
| C626     | 0CQ3331N509 | 0.033UF D 100V 10% PE TP5        |
| C627     | 0CK1030K945 | 0.01UF 50V Z F TR                |
| C632     | 0CQ3331N509 | 0.033UF D 100V 10% PE TP5        |
| C636     | 0CQ3331N509 | 0.033UF D 100V 10% PE TP5        |
| C803     | 0CE337KV6A0 | 330UF SLT 450V 20% VNSN BULK     |
| C803     | 181-001V    | CE 450V 220UF M LUG(85)          |
| C804     | 0CK10201515 | 1000P 1KV K B TS                 |



|  |   |  |
|--|---|--|
| For Capacitor & Resistors,<br>the characters at 2nd and 3rd<br>digit in the P/No. means as<br>follows; | CC, CX, CK, CN : Ceramic<br>CQ : Polyester<br>CE : Electrolytic | RD : Carbon Film<br>RS : Metal Oxide Film<br>RN : Metal Film<br>RF : Fusible |
|--|---|--|

| LOCA. NO | PART NO     | DESCRIPTION                       |
|----------|-------------|-----------------------------------|
| C806     | 0CK10201515 | 1000P 1KV K B TS                  |
| C807     | 181-091X    | R 560PF 2KV 10%,-10% R/TP TP7.5   |
| C809     | 0CE105DK618 | 1UF STD 50V M FL TP5              |
| C810     | 0CE336DK618 | 33UF STD 50V M FL TP5             |
| C811     | 181-011B    | 0.001UF D 1.6KV J M/PP NI FM20    |
| C815     | 0CK8210K515 | 820P 50V K B TS                   |
| C816     | 0CQZVBK002A | A.C 275V 0.1UF M (S=15)           |
| C817     | 0CK1040K945 | 0.1UF 50V Z F TR                  |
| C818     | 0CQZVBK002C | A.C 275V 0.22UF K (S=22.5)        |
| C819     | 0CK1520K515 | 1500P 50V K B TS                  |
| C820     | 0CN1040K949 | 0.1UF D 50V 80%,-20% F(Y5V) TA52  |
| C821     | 0CK4710W515 | 470PF 500V K B TR                 |
| C822     | 0CE477DH618 | 470UF STD 25V M FL TP5            |
| C823     | 0CE477DD618 | 470UF STD 10V M FL TP5            |
| C824     | 0CE108DD618 | 1000UF STD 10V M FL TP5           |
| C826     | 0CE108DD618 | 1000UF STD 10V M FL TP5           |
| C827     | 0CE108DD618 | 1000UF STD 10V M FL TP5           |
| C828     | 0CE477DD618 | 470UF STD 10V M FL TP5            |
| C829     | 0CE335CK636 | 3.3UF SHL,SD 50V 20% FM5 BP(D) TP |
| C830     | 0CE108DH618 | 1000UF STD 25V M FL TP5           |
| C831     | 0CE227DP61A | 220UF STD 160V 20% FL TP 7.5      |
| C833     | 0CE107CP618 | 100U SHL 160V M FL TP5            |
| C835     | 0CK4710W515 | 470PF 500V K B TR                 |
| C836     | 0CK12202510 | 1200P 2KV K B S                   |
| C837     | 0CQ4731N509 | 0.047UF D 100V 10% PE TP5         |
| C838     | 0CE227DK618 | 220UF STD 50V M FL TP5            |
| C840     | 0CE228BF618 | 2200UF KME 16V M FL TP5           |
| C843     | 181-120K    | 2200PF 4KV M E FMTW LEAD 4.5      |
| C845     | 0CE107DD618 | 100UF STD 10V M FL TP5            |
| C901     | 0CE475DR618 | 4.7UF STD 250V 20% FL TP 5        |
| C902     | 0CQ1044R539 | 0.1UF TE 250V 10% M/PE NI TP5     |
| C903     | 181-033S    | 2KV B 122K TP7.5                  |
| C904     | 0CE475DR618 | 4.7UF STD 250V 20% FL TP 5        |

**COIL & INDUCTOR**

|      |             |   |
|------|-------------|---|
| L101 | 0LA0102K139 | INDUCTOR,10UH K 4*10.5 TP                   |
| L103 | 0LA0101K119 | INDUCTOR,1.0UH K 2.3*3.4 TP                 |
| L11  | 0LA0102K119 | INDUCTOR,10UH K 2.3*3.4 TP                  |
| L12  | 0LA0101K119 | INDUCTOR,1.0UH K 2.3*3.4 TP                 |
| L202 | 0LA0102K119 | INDUCTOR,10UH K 2.3*3.4 TP                  |
| L208 | 0LA0102K119 | INDUCTOR,10UH K 2.3*3.4 TP                  |
| L211 | 0LA0102K119 | INDUCTOR,10UH K 2.3*3.4 TP                  |
| L213 | 0LA0102K119 | INDUCTOR,10UH K 2.3*3.4 TP                  |
| L251 | 0LA0102K119 | INDUCTOR,10UH K 2.3*3.4 TP                  |
| L252 | 0LA0102K119 | INDUCTOR,10UH K 2.3*3.4 TP                  |
| L253 | 0LA0472K119 | INDUCTOR,47UH K 2.3*3.4 TP                  |
| L254 | 0LA0472K119 | INDUCTOR,47UH K 2.3*3.4 TP                  |
| L401 | 6140VE0001V | COIL,60UH 0.6PHY 69.5TURN CH-1012S MC019A   |
| L402 | 6140VB0001F | COIL,130UH 0.45PHY 55.5TURN CH-1012S MC019A |
| L501 | 0LA0102K119 | INDUCTOR,10UH K 2.3*3.4 TP                  |
| L502 | 0LA0102K119 | INDUCTOR,10UH K 2.3*3.4 TP                  |
| L503 | 0LA0102K119 | INDUCTOR,10UH K 2.3*3.4 TP                  |

| LOCA. NO | PART NO     | DESCRIPTION                           |
|----------|-------------|---------------------------------------|
| L504     | 0LA0101K119 | INDUCTOR,1.0UH K 2.3*3.4 TP           |
| L505     | 0LA0102K119 | INDUCTOR,10UH K 2.3*3.4 TP            |
| L506     | 0LA0102K119 | INDUCTOR,10UH K 2.3*3.4 TP            |
| L507     | 0LA0101K119 | INDUCTOR,1.0UH K 2.3*3.4 TP           |
| L508     | 0LA0101K119 | INDUCTOR,1.0UH K 2.3*3.4 TP           |
| L509     | 0LA0102K119 | INDUCTOR,10UH K 2.3*3.4 TP            |
| L801     | 150-C02F    | COIL,CHOKE 82UH PHY TURN              |
| T401     | 151-C02F    | TRANSFORMER,H-DRIVE,EI-19,BULK        |
| T803     | 6170VMCA43J | TRANSFORMER,EER3940 400UH RT-21FA35RQ |

**RESISTOR**

|       |             |                               |
|-------|-------------|-------------------------------|
| F802  | 0RP0050H709 | 0.05 OHM 1/2 W 10% TA52       |
| F804  | 0RP0050H709 | 0.05 OHM 1/2 W 10% TA52       |
| F805  | 0RP0020J809 | 0.02 OHM 1 W 20% TA52         |
| F806  | 0RP0020J809 | 0.02 OHM 1 W 20% TA52         |
| FR401 | 0RF0141K607 | 1.4 OHM 2 W 5.00% TA62        |
| FR901 | 0RF0141K607 | 1.4 OHM 2 W 5.00% TA62        |
| J202  | 0RD1000F609 | 100 OHM 1/6 W 5% TA52         |
| J203  | 0RD1000F609 | 100 OHM 1/6 W 5% TA52         |
| J204  | 0RD1000F609 | 100 OHM 1/6 W 5% TA52         |
| J211  | 0RD1000F609 | 100 OHM 1/6 W 5% TA52         |
| J402  | 0RD0752F609 | 75 OHM 1/6 W 5.00% TA52       |
| R102  | 0RD6801F609 | 6.8K OHM 1/6 W 5.00% TA52     |
| R109  | 0RD0562F609 | 56 OHM 1/6 W 5.00% TA52       |
| R110  | 0RD8200F609 | 820 OHM 1/6 W 5.00% TA52      |
| R111  | 0RD0682F609 | 68 OHM 1/6 W 5.00% TA52       |
| R112  | 0RD1501F609 | 1.5K OHM 1/6 W 5% TA52        |
| R113  | 0RD3000F609 | 300 OHM 1/6 W 5.00% TA52      |
| R12   | 0RD1000F609 | 100 OHM 1/6 W 5% TA52         |
| R124  | 0RD2202F609 | 22K OHM 1/6 W 5% TA52         |
| R125  | 0RD2700A609 | 270 OHM 1/2 W(7.0) 5.00% TA52 |
| R126  | 0RD1000F609 | 100 OHM 1/6 W 5% TA52         |
| R127  | 0RD1000F609 | 100 OHM 1/6 W 5% TA52         |
| R13   | 0RD1301F609 | 1.3K OHM 1/6 W 5.00% TA52     |
| R14   | 0RD4701F609 | 4.7K OHM 1/6 W 5% TA52        |
| R15   | 0RD3300F609 | 330 OHM 1/6 W 5.00% TA52      |
| R16   | 0RD2200F609 | 220 OHM 1/6 W 5.00% TA52      |
| R17   | 0RD3000F609 | 300 OHM 1/6 W 5.00% TA52      |
| R18   | 0RD3300F609 | 330 OHM 1/6 W 5.00% TA52      |
| R19   | 0RD3900F609 | 390 OHM 1/6 W 5% TA52         |
| R20   | 0RD4300F609 | 430 OHM 1/6 W 5.00% TA52      |
| R204  | 0RD0752F609 | 75 OHM 1/6 W 5.00% TA52       |
| R205  | 0RD0752F609 | 75 OHM 1/6 W 5.00% TA52       |
| R212  | 0RD0752F609 | 75 OHM 1/6 W 5.00% TA52       |
| R213  | 0RD0752F609 | 75 OHM 1/6 W 5.00% TA52       |
| R24   | 0RD1000F609 | 100 OHM 1/6 W 5% TA52         |
| R25   | 0RD1000F609 | 100 OHM 1/6 W 5% TA52         |
| R252  | 0RD1200A609 | 120 OHM 1/2 W(7.0) 5.00% TA52 |
| R253  | 0RD1200A609 | 120 OHM 1/2 W(7.0) 5.00% TA52 |
| R28   | 0RD1000F609 | 100 OHM 1/6 W 5% TA52         |
| R29   | 0RD1000F609 | 100 OHM 1/6 W 5% TA52         |
| R30   | 0RD3301F609 | 3.3K OHM 1/6 W 5.00% TA52     |



|   |   |  |
|---|---|--|
| For Capacitor & Resistors, the characters at 2nd and 3rd digit in the P/No. means as follows; | CC, CX, CK, CN : Ceramic<br>CQ : Polyester<br>CE : Electrolytic | RD : Carbon Film<br>RS : Metal Oxide Film<br>RN : Metal Film<br>RF : Fusible |
|---|---|--|

| LOCA. NO | PART NO     | DESCRIPTION                    |
|----------|-------------|--------------------------------|
| R302     | 0RN3602F409 | 36K OHM 1/6 W 1.00% TA52       |
| R303     | 0RD2400A609 | 240 OHM 1/2 W(7.0) 5.00% TA52  |
| R304     | 0RD0561A609 | 5.6 OHM 1/2 W(7.0) 5.00% TA52  |
| R305     | 0RD1002F609 | 10K OHM 1/6 W 5% TA52          |
| R306     | 0RD1002F609 | 10K OHM 1/6 W 5% TA52          |
| R307     | 0RD3601F609 | 3.6K OHM 1/6 W 5.00% TA52      |
| R308     | 0RN4702F409 | 47K OHM 1/6 W 1.00% TA52       |
| R309     | 0RD2001F609 | 2K OHM 1/6 W 5% TA52           |
| R31      | 0RD3301F609 | 3.3K OHM 1/6 W 5.00% TA52      |
| R310     | 0RN4702F409 | 47K OHM 1/6 W 1.00% TA52       |
| R312     | 0RD4701F609 | 4.7K OHM 1/6 W 5% TA52         |
| R313     | 0RN0471H609 | 4.7 OHM 1/2 W 5.00% TA52       |
| R314     | 0RN0471H609 | 4.7 OHM 1/2 W 5.00% TA52       |
| R315     | 0RS2700K607 | 270 OHM 2 W 5.00% TA62         |
| R32      | 0RD3301F609 | 3.3K OHM 1/6 W 5.00% TA52      |
| R328     | 0RN3602F409 | 36K OHM 1/6 W 1.00% TA52       |
| R33      | 0RD1000F609 | 100 OHM 1/6 W 5% TA52          |
| R34      | 0RD1000F609 | 100 OHM 1/6 W 5% TA52          |
| R35      | 0RD1000F609 | 100 OHM 1/6 W 5% TA52          |
| R37      | 0RD1000F609 | 100 OHM 1/6 W 5% TA52          |
| R38      | 0RD1002F609 | 10K OHM 1/6 W 5% TA52          |
| R403     | 0RD5600A609 | 560 OHM 1/2 W(7.0) 0.05 TA52   |
| R404     | 0RD0332A609 | 33 OHM 1/2 W(7.0) 5.00% TA52   |
| R405     | 0RS8200K607 | 820 OHM 2 W 5.00% TA62         |
| R409     | 0RD1501A609 | 1.5K OHM 1/2 W(7.0) 5.00% TA52 |
| R410     | 0RS2702K607 | 27K OHM 2 W 5.00% TA62         |
| R412     | 0RD7501A609 | 7.5K OHM 1/2 W(7.0) 5.00% TA52 |
| R42      | 0RD4701F609 | 4.7K OHM 1/6 W 5% TA52         |
| R421     | 0RD3600F609 | 360 OHM 1/6 W 5.00% TA52       |
| R422     | 0RD1002F609 | 10K OHM 1/6 W 5% TA52          |
| R501     | 0RD3301F609 | 3.3K OHM 1/6 W 5.00% TA52      |
| R502     | 0RN6801F409 | 6.8K OHM 1/6 W 1.00% TA52      |
| R503     | 0RN6801F409 | 6.8K OHM 1/6 W 1.00% TA52      |
| R505     | 0RD1000F609 | 100 OHM 1/6 W 5% TA52          |
| R506     | 0RD2202F609 | 22K OHM 1/6 W 5% TA52          |
| R507     | 0RD3300F609 | 330 OHM 1/6 W 5.00% TA52       |
| R508     | 0RD1201F609 | 1.2K OHM 1/6 W 5% TA52         |
| R509     | 0RD3600F609 | 360 OHM 1/6 W 5.00% TA52       |
| R510     | 0RD3600F609 | 360 OHM 1/6 W 5.00% TA52       |
| R511     | 0RD3600F609 | 360 OHM 1/6 W 5.00% TA52       |
| R512     | 0RD0332F609 | 33 OHM 1/6 W 5.00% TA52        |
| R513     | 0RD0332F609 | 33 OHM 1/6 W 5.00% TA52        |
| R514     | 0RD0332F609 | 33 OHM 1/6 W 5.00% TA52        |
| R515     | 0RD1600F609 | 160 OHM 1/6 W 5.00% TA52       |
| R516     | 0RD1600F609 | 160 OHM 1/6 W 5.00% TA52       |
| R517     | 0RD1600F609 | 160 OHM 1/6 W 5.00% TA52       |
| R518     | 0RD0222F609 | 22 OHM 1/6 W 5.00% TA52        |
| R519     | 0RD2701F609 | 2.7K OHM 1/6 W 5% TA52         |
| R520     | 0RD1001F609 | 1K OHM 1/6 W 5% TA52           |
| R521     | 0RD3002F609 | 30K OHM 1/6 W 5.00% TA52       |
| R522     | 0RD0152F609 | 15 OHM 1/6 W 5.00% TA52        |
| R523     | 0RD1000F609 | 100 OHM 1/6 W 5% TA52          |

| LOCA. NO | PART NO     | DESCRIPTION                   |
|----------|-------------|-------------------------------|
| R524     | 0RD1000F609 | 100 OHM 1/6 W 5% TA52         |
| R526     | 0RD1201F609 | 1.2K OHM 1/6 W 5% TA52        |
| R527     | 0RD2702F609 | 27K OHM 1/6 W 5.00% TA52      |
| R530     | 0RD3304F609 | 3.3M OHM 1/6 W 5.00% TA52     |
| R532     | 0RD1000F609 | 100 OHM 1/6 W 5% TA52         |
| R534     | 0RD1201F609 | 1.2K OHM 1/6 W 5% TA52        |
| R535     | 0RD2200F609 | 220 OHM 1/6 W 5.00% TA52      |
| R536     | 0RD1801F609 | 1.8K OHM 1/6 W 5.00% TA52     |
| R539     | 0RD1002F609 | 10K OHM 1/6 W 5% TA52         |
| R540     | 0RD4702F609 | 47K OHM 1/6 W 5% TA52         |
| R542     | 0RD8200F609 | 820 OHM 1/6 W 5.00% TA52      |
| R543     | 0RD9100F609 | 910 OHM 1/6 W 5.00% TA52      |
| R545     | 0RD1002F609 | 10K OHM 1/6 W 5% TA52         |
| R555     | 0RD6800F609 | 680 OHM 1/6 W 5% TA52         |
| R557     | 0RD3301F609 | 3.3K OHM 1/6 W 5.00% TA52     |
| R558     | 0RD3001F609 | 3K OHM 1/6 W 5.00% TA52       |
| R562     | 0RD0752F609 | 75 OHM 1/6 W 5.00% TA52       |
| R563     | 0RD0752F609 | 75 OHM 1/6 W 5.00% TA52       |
| R601     | 0RD0221A609 | 2.2 OHM 1/2 W(7.0) 5.00% TA52 |
| R602     | 0RD0221A609 | 2.2 OHM 1/2 W(7.0) 5.00% TA52 |
| R603     | 0RD0221A609 | 2.2 OHM 1/2 W(7.0) 5.00% TA52 |
| R604     | 0RD0221A609 | 2.2 OHM 1/2 W(7.0) 5.00% TA52 |
| R605     | 0RD1001F609 | 1K OHM 1/6 W 5% TA52          |
| R606     | 0RD3901F609 | 3.9K OHM 1/6 W 5% TA52        |
| R607     | 0RD1002F609 | 10K OHM 1/6 W 5% TA52         |
| R608     | 0RD1001F609 | 1K OHM 1/6 W 5% TA52          |
| R609     | 0RD1000F609 | 100 OHM 1/6 W 5% TA52         |
| R610     | 0RD1802F509 | 18K OHM 1/6 W 2.00% TA52      |
| R611     | 0RD1001F609 | 1K OHM 1/6 W 5% TA52          |
| R612     | 0RD3901F609 | 3.9K OHM 1/6 W 5% TA52        |
| R613     | 0RD0221F609 | 2.2 OHM 1/6 W 5.00% TA52      |
| R614     | 0RD1000F609 | 100 OHM 1/6 W 5% TA52         |
| R615     | 0RD1001F609 | 1K OHM 1/6 W 5% TA52          |
| R616     | 0RD2700F609 | 270 OHM 1/6 W 5% TA52         |
| R617     | 0RD6801F609 | 6.8K OHM 1/6 W 5.00% TA52     |
| R618     | 0RD6801F609 | 6.8K OHM 1/6 W 5.00% TA52     |
| R619     | 0RD6801F609 | 6.8K OHM 1/6 W 5.00% TA52     |
| R620     | 0RD1000F609 | 100 OHM 1/6 W 5% TA52         |
| R621     | 0RD6801F609 | 6.8K OHM 1/6 W 5.00% TA52     |
| R624     | 0RD6801F609 | 6.8K OHM 1/6 W 5.00% TA52     |
| R664     | 0RD6801F609 | 6.8K OHM 1/6 W 5.00% TA52     |
| R802     | 0RKZVTA001K | 0.47M OHM 1/2 W 5% TA52       |
| R803     | 180-822N    | RWR 7W 1.0 OHM J PD           |
| R804     | 0RS4702K619 | 47K OHM 2 W 5% TR             |
| R805     | 0RS4702K619 | 47K OHM 2 W 5% TR             |
| R806     | 180-A01N    | 0.18 OHM 2 W 5% TA62 PRW      |
| R807     | 0RD2200A609 | 220 OHM 1/2 W(7.0) 5.00% TA52 |
| R808     | 0RD1501F609 | 1.5K OHM 1/6 W 5% TA52        |
| R809     | 0RD1001F609 | 1K OHM 1/6 W 5% TA52          |
| R810     | 0RD0472F609 | 47 OHM 1/6 W 5% TA52          |
| R814     | 0RK8204H609 | 8.2M OHM 1/2 W 5.00% TA52     |
| R816     | 0RD1001F609 | 1K OHM 1/6 W 5% TA52          |

|  |   |  |
|--|---|--|
| For Capacitor & Resistors,<br>the characters at 2nd and 3rd<br>digit in the P/No. means as<br>follows; | CC, CX, CK, CN : Ceramic<br>CQ : Polyester<br>CE : Electrolytic | RD : Carbon Film<br>RS : Metal Oxide Film<br>RN : Metal Film<br>RF : Fusible |
|--|---|--|

| LOCA. NO                    | PART NO     | DESCRIPTION                              |
|-----------------------------|-------------|--|
| R817                        | ORD0152F609 | 15 OHM 1/6 W 5.00% TA52                  |
| R823                        | ORD4701F609 | 4.7K OHM 1/6 W 5% TA52                   |
| R827                        | ORD1001F609 | 1K OHM 1/6 W 5% TA52                     |
| R828                        | ORD1501F609 | 1.5K OHM 1/6 W 5% TA52                   |
| R831                        | ORD2201F609 | 2.2K OHM 1/6 W 5.00% TA52                |
| R838                        | ORD4701F609 | 4.7K OHM 1/6 W 5% TA52                   |
| R858                        | ORD4701F609 | 4.7K OHM 1/6 W 5% TA52                   |
| R903                        | ORD2200F609 | 220 OHM 1/6 W 5.00% TA52                 |
| R904                        | ORD2200F609 | 220 OHM 1/6 W 5.00% TA52                 |
| R905                        | ORD2200F609 | 220 OHM 1/6 W 5.00% TA52                 |
| R906                        | ORD1000F609 | 100 OHM 1/6 W 5% TA52                    |
| R907                        | ORD1000F609 | 100 OHM 1/6 W 5% TA52                    |
| R908                        | ORD1000F609 | 100 OHM 1/6 W 5% TA52                    |
| R909                        | 0RCZVTA002D | 1/2 W 1.5K,10%,PLIKOR(HIGH SURGE)        |
| R910                        | 0RCZVTA002D | 1/2 W 1.5K,10%,PLIKOR(HIGH SURGE)        |
| R911                        | 0RCZVTA002D | 1/2 W 1.5K,10%,PLIKOR(HIGH SURGE)        |
| R912                        | ORD2204A609 | 2.2M OHM 1/2 W(7.0) 5.00% TA52           |
| R914                        | ORD0102F609 | 10 OHM 1/6 W 5% TA52                     |
| <b>SWITCH</b>               |             |  |
| SW11                        | 140-315A    | TACT SKHV17910B LG C&D 12V               |
| SW12                        | 140-315A    | TACT SKHV17910B LG C&D 12V               |
| SW13                        | 140-315A    | TACT SKHV17910B LG C&D 12V               |
| SW14                        | 140-315A    | TACT SKHV17910B LG C&D 12V               |
| SW15                        | 140-315A    | TACT SKHV17910B LG C&D 12V               |
| SW16                        | 140-315A    | TACT SKHV17910B LG C&D 12V               |
| SW801                       | 6600VM2002A | SDKEA3 ALPS IEC 250V 8A HORIZONTAL 480G  |
| <b>FILTER &amp; CRYSTAL</b> |             |  |
| FB201                       | 125-123A    | FERRITE BFD3565R2F(TAPING)               |
| FB801                       | 125-022K    | FERRITE AXIAL 62MM 1UH NY 3.5X6.0MM      |
| FB802                       | 125-022K    | FERRITE AXIAL 62MM 1UH NY 3.5X6.0MM      |
| FB803                       | 125-022K    | FERRITE AXIAL 62MM 1UH NY 3.5X6.0MM      |
| FB825                       | 125-022K    | FERRITE AXIAL 62MM 1UH NY 3.5X6.0MM      |
| T802                        | 150-F06W    | SQE2930 36MH 0.5PHY 105TURN .            |
| X11                         | 6202VDB007B | RESONATOR,HC49U 20.250MHZ 30PPM 13PF BK  |
| Z101                        | 6200QL3001Z | B39361-X6966-D100 EPCOS ST               |
| <b>ACCESSORIES</b>          |             |  |
| A1                          | 3828VA0474A | MANUAL,OWNERS LG EN 090A/D TX            |
| A1                          | 3828VA0474L | MANUAL,OWNERS MC049B UKR/BZ03 LG RU/EN   |
| A1                          | 3828VA0474R | MANUAL,OWNERS MC049B AK/TURKM LG EN      |
| A2                          | 6710V00124D | REMOTE CONTROLLER,MC049B W/O TXT         |
| A2                          | 6710V00124E | REMOTE CONTROLLER, MC049B TXT RT-21FA35  |
| A3                          | 5010V00004B | ANTENNA,3SECTION 750MM NTSC W/ADP        |
| <b>MISCELLANEOUS</b>        |             |  |
| F801                        | 0FS4001B53C | FUSE,4000MA 250 V 5.2X20                 |
| JK202                       | 6612VJH023D | JACK,RCA PPJ 126-04 PIN JACK             |
| P902                        | 387-603E    | CONNECTOR,9P 2.5MM 430MM B-B UL1007AWG26 |
| PA01                        | 6712SCA226B | REMOTE CONTROLLER RECEIVER,KSM-913LG1T   |
| PJ201                       | 6613V00006A | JACK ASSY 3P+EAR(PJ6062A)                |

| LOCA. NO | PART NO     | DESCRIPTION                            |
|----------|-------------|--|
| SK901    | 6620VBC003A | SOCKET (CIRC),CPTPCS030A 8PIN 14/360   |
| T402     | 6174V-6006M | FBT,BSC25-N1648 21 YY .                |
| TH801    | 163-051F    | THERMISTOR,PTC J503P84D140M290Q        |
| TU101    | 6700VS0002F | TUNER,TAEW-G002D W/W ALL IN W/S 09Z VE |
| VD801    | 164-003G    | VARISTOR,TVR621D14A THINKING 620V 10%  |

# MC-049B CIRCUIT DIAGRAM 040531

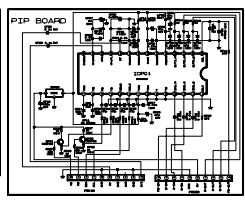
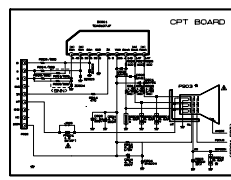
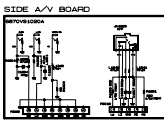
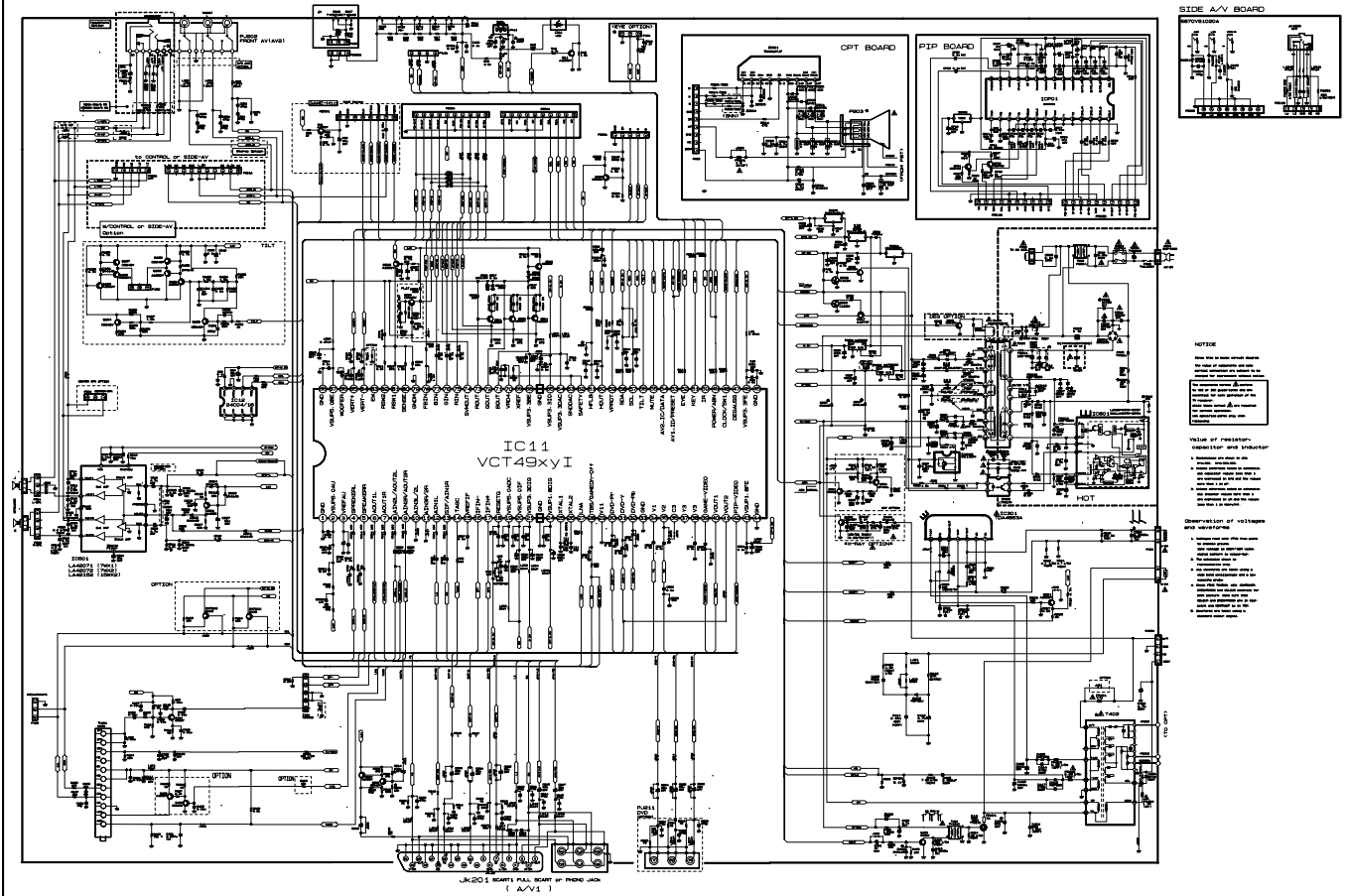

**NOTE**

1. THIS CIRCUIT IS DESIGNED TO OPERATE WITH THE FOLLOWING COMPONENTS:

2. THE CIRCUIT IS DESIGNED TO OPERATE WITH THE FOLLOWING COMPONENTS:

3. THE CIRCUIT IS DESIGNED TO OPERATE WITH THE FOLLOWING COMPONENTS:

4. THE CIRCUIT IS DESIGNED TO OPERATE WITH THE FOLLOWING COMPONENTS:

5. THE CIRCUIT IS DESIGNED TO OPERATE WITH THE FOLLOWING COMPONENTS:

6. THE CIRCUIT IS DESIGNED TO OPERATE WITH THE FOLLOWING COMPONENTS:

7. THE CIRCUIT IS DESIGNED TO OPERATE WITH THE FOLLOWING COMPONENTS:

8. THE CIRCUIT IS DESIGNED TO OPERATE WITH THE FOLLOWING COMPONENTS:

9. THE CIRCUIT IS DESIGNED TO OPERATE WITH THE FOLLOWING COMPONENTS:

10. THE CIRCUIT IS DESIGNED TO OPERATE WITH THE FOLLOWING COMPONENTS:

**SVC. SHEET : 3854VA0162A-S**



P/NO : 3828VD0188H

Sep.,2004  
Printed in Korea

