

Download Service Manual And Resetter Printer at <http://printer1.blogspot.com>

# SERVICE MANUAL

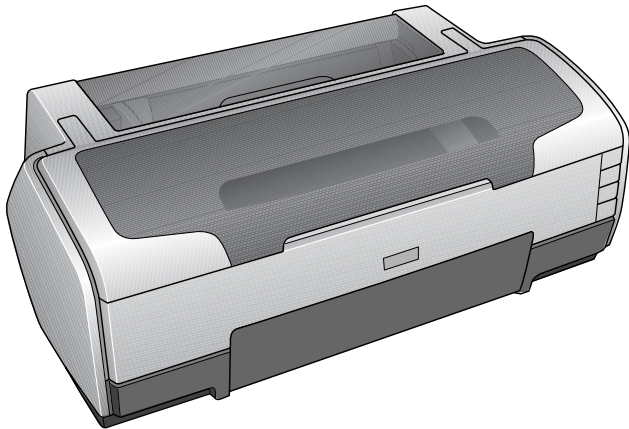

Color Inkjet Printer

**EPSON Stylus Photo R1800/R2400**

**EPSON**

SEIJ04015

## Notice:

- All rights reserved. No part of this manual may be reproduced, stored in a retrieval system, or transmitted in any form or by any means, electronic, mechanical, photocopying, recording, or otherwise, without the prior written permission of SEIKO EPSON CORPORATION.
- The contents of this manual are subject to change without notice.
- All effort have been made to ensure the accuracy of the contents of this manual. However, should any errors be detected, SEIKO EPSON would greatly appreciate being informed of them.
- The above notwithstanding SEIKO EPSON CORPORATION can assume no responsibility for any errors in this manual or the consequences thereof.

EPSON is a registered trademark of SEIKO EPSON CORPORATION.

General Notice: Other product names used herein are for identification purpose only and may be trademarks or registered trademarks of their respective owners. EPSON disclaims any and all rights in those marks.

Copyright © 2005 **SEIKO EPSON CORPORATION.**  
**I&I CS/Quality Management & PL Department**

# PRECAUTIONS

Precautionary notations throughout the text are categorized relative to 1) Personal injury and 2) damage to equipment.

**DANGER** Signals a precaution which, if ignored, could result in serious or fatal personal injury. Great caution should be exercised in performing procedures preceded by DANGER Headings.

**WARNING** Signals a precaution which, if ignored, could result in damage to equipment.

The precautionary measures itemized below should always be observed when performing repair/maintenance procedures.

## **DANGER**

1. ALWAYS DISCONNECT THE PRODUCT FROM THE POWER SOURCE AND PERIPHERAL DEVICES PERFORMING ANY MAINTENANCE OR REPAIR PROCEDURES.
2. NO WORK SHOULD BE PERFORMED ON THE UNIT BY PERSONS UNFAMILIAR WITH BASIC SAFETY MEASURES AS DICTATED FOR ALL ELECTRONICS TECHNICIANS IN THEIR LINE OF WORK.
3. WHEN PERFORMING TESTING AS DICTATED WITHIN THIS MANUAL, DO NOT CONNECT THE UNIT TO A POWER SOURCE UNTIL INSTRUCTED TO DO SO. WHEN THE POWER SUPPLY CABLE MUST BE CONNECTED, USE EXTREME CAUTION IN WORKING ON POWER SUPPLY AND OTHER ELECTRONIC COMPONENTS.

## **WARNING**

1. REPAIRS ON EPSON PRODUCT SHOULD BE PERFORMED ONLY BY AN EPSON CERTIFIED REPAIR TECHNICIAN.
2. MAKE CERTAIN THAT THE SOURCE VOLTAGES IS THE SAME AS THE RATED VOLTAGE, LISTED ON THE SERIAL NUMBER/RATING PLATE. IF THE EPSON PRODUCT HAS A PRIMARY AC RATING DIFFERENT FROM AVAILABLE POWER SOURCE, DO NOT CONNECT IT TO THE POWER SOURCE.
3. ALWAYS VERIFY THAT THE EPSON PRODUCT HAS BEEN DISCONNECTED FROM THE POWER SOURCE BEFORE REMOVING OR REPLACING PRINTED CIRCUIT BOARDS AND/OR INDIVIDUAL CHIPS.
4. IN ORDER TO PROTECT SENSITIVE MICROPROCESSORS AND CIRCUITRY, USE STATIC DISCHARGE EQUIPMENT, SUCH AS ANTI-STATIC WRIST STRAPS, WHEN ACCESSING INTERNAL COMPONENTS.
5. REPLACE MALFUNCTIONING COMPONENTS ONLY WITH THOSE COMPONENTS BY THE MANUFACTURE; INTRODUCTION OF SECOND-SOURCE ICs OR OTHER NON-APPROVED COMPONENTS MAY DAMAGE THE PRODUCT AND VOID ANY APPLICABLE EPSON WARRANTY.

# About This Manual

This manual describes basic functions, theory of electrical and mechanical operations, maintenance and repair procedures of the printer. The instructions and procedures included herein are intended for the experienced repair technicians, and attention should be given to the precautions on the preceding page.

## Manual Configuration

This manual consists of six chapters and Appendix.

### **CHAPTER 1.PRODUCT DESCRIPTIONS**

Provides a general overview and specifications of the product.

### **CHAPTER 2.OPERATING PRINCIPLES**

Describes the theory of electrical and mechanical operations of the product.

### **CHAPTER 3.TROUBLESHOOTING**

Describes the step-by-step procedures for the troubleshooting.

### **CHAPTER 4.DISASSEMBLY / ASSEMBLY**

Describes the step-by-step procedures for disassembling and assembling the product.

### **CHAPTER 5.ADJUSTMENT**

Provides Epson-approved methods for adjustment.

### **CHAPTER 6.MAINTENANCE**

Provides preventive maintenance procedures and the lists of Epson-approved lubricants and adhesives required for servicing the product.

**APPENDIX** Provides the following additional information for reference:

- Connector pin assignments
- Exploded diagram & Parts List
- Electric circuit boards components layout
- Electrical circuit boards schematics

## Symbols Used in this Manual

Various symbols are used throughout this manual either to provide additional information on a specific topic or to warn of possible danger present during a procedure or an action. Be aware of all symbols when they are used, and always read NOTE, CAUTION, or WARNING messages.



Indicates an operating or maintenance procedure, practice or condition that is necessary to keep the product's quality.



Indicates an operating or maintenance procedure, practice, or condition that, if not strictly observed, could result in damage to, or destruction of, equipment.



May indicate an operating or maintenance procedure, practice or condition that is necessary to accomplish a task efficiently. It may also provide additional information that is related to a specific subject, or comment on the results achieved through a previous action.



Indicates an operating or maintenance procedure, practice or condition that, if not strictly observed, could result in injury or loss of life.



Indicates that a particular task must be carried out according to a certain standard after disassembly and before re-assembly, otherwise the quality of the components in question may be adversely affected.



# Revision Status

Revision	Date of Issue	Description
A	January 21, 2005	First Release
B	March 31, 2005	Revised Contents <ul style="list-style-type: none"><li>■ <a href="#">8. Stylus Photo R2400 (p198)</a><ul style="list-style-type: none"><li>• Stylus Photo specific information is added.</li></ul></li><li>■ <a href="#">5.2.5.1 Printing Calibration Chart by Users (p165)</a><ul style="list-style-type: none"><li>• Descriptions of the procedure are added.</li></ul></li><li>■ <a href="#">5.2.5.2 Writing of Color ID by Users (p169)</a><ul style="list-style-type: none"><li>• A caution is deleted.</li></ul></li><li>■ <a href="#">Color Correction Value Entry Procedure (p170)</a><ul style="list-style-type: none"><li>• Supported OS and ports are added.</li></ul></li><li>■ <a href="#">Calibration Chart Print Procedure for Users (p166)</a><ul style="list-style-type: none"><li>• Descriptions of the procedure are added.</li></ul></li></ul>

# CONTENTS

## Chapter 1 Product Description

<b>1.1 Overview</b> .....	<b>9</b>
<b>1.2 PG Setting</b> .....	<b>10</b>
<b>1.3 Functions</b> .....	<b>11</b>
1.3.1 Control Panel .....	11
1.3.2 Switches .....	11
1.3.3 Indicators .....	11
1.3.4 Switch Functions .....	11
1.3.5 Indicator Display in Normal Mode .....	12
1.3.6 Error Status .....	13
<b>1.4 Casing Specifications</b> .....	<b>14</b>
<b>1.5 Accessories</b> .....	<b>14</b>

## Chapter 2 Operating Principles

<b>2.1 Overview</b> .....	<b>16</b>
<b>2.2 Printer Mechanism</b> .....	<b>16</b>
2.2.1 Carriage Mechanism .....	17
2.2.2 Printhead Specifications .....	20
2.2.3 Paper Feeding Mechanism .....	20
2.2.4 Paper Feeding Mechanism .....	25
2.2.5 Ink System Mechanism .....	26
2.2.6 Ink Sequence .....	28
2.2.7 Power-On Sequence .....	30
<b>2.3 Electrical Circuit Operating Principles</b> .....	<b>31</b>
2.3.1 Power Supply Circuit Operating Principle .....	32
2.3.2 C589 MAIN Circuit Operating Principle .....	33

## Chapter 3 Troubleshooting

<b>3.1 Overview</b> .....	<b>36</b>
3.1.1 Troubleshooting according to Panel Messages .....	36
3.1.2 Troubleshooting based on Observed Faults .....	59

## Chapter 4 Disassembly And Assembly

<b>4.1 Overview</b> .....	<b>69</b>
4.1.1 Precautions .....	69
4.1.2 Tools .....	70
4.1.3 Screws .....	71
4.1.4 Work Completion Checklist .....	72
<b>4.2 Disassembly</b> .....	<b>73</b>
4.2.1 Removing the Housings .....	74
4.2.2 Waste Ink Pad .....	80
4.2.3 Front Paper Guide Pad .....	82
4.2.4 ASF Assy .....	83
4.2.5 Removing the Boards .....	87
4.2.6 Disassembling the Printer Mechanism .....	89
4.2.7 Removing the Motors .....	122
4.2.8 Removing the Sensors .....	124

## Chapter 5 Adjustment

<b>5.1 Adjustment Items and Overview</b> .....	<b>129</b>
5.1.1 Servicing Adjustment Item List .....	129
5.1.2 Replacement Part-Based Adjustment Priorities .....	133
5.1.3 Required Adjustment Tools .....	136
<b>5.2 Adjustment</b> .....	<b>137</b>
5.2.1 PF Belt Tension Adjustment .....	137
5.2.2 PG Adjustment .....	139
5.2.3 PF Roller Shaft Center Support Position Adjustment .....	143
5.2.4 Colorimetric Calibration .....	147
5.2.5 Colorimetric Calibration by Users .....	165

## Chapter 6 Maintenance

<b>6.1 Overview</b> .....	<b>173</b>
6.1.1 ROM Replacement .....	173
6.1.2 Cleaning .....	173
6.1.3 Service Maintenance .....	174

6.1.4 Lubrication .....	175
-------------------------	-----

## Chapter 7 Appendix

---

<b>7.1 Connector Summary .....</b>	<b>182</b>
7.1.1 Connectors and Pin Layouts .....	182
<b>7.2 Exploded Diagram .....</b>	<b>183</b>
<b>7.3 Parts List for EPSON Stylus Photo R1800 .....</b>	<b>190</b>
<b>7.4 Circuit Diagram .....</b>	<b>192</b>

## Chapter 8 Stylus Photo R2400

---

<b>8.1 Overview .....</b>	<b>199</b>
8.1.1 Overview .....	199
8.1.2 Indicator Display in Normal Mode .....	200
8.1.3 Error Status .....	201
<b>8.2 Casing Specifications .....</b>	<b>202</b>
<b>8.3 Accessories .....</b>	<b>202</b>
8.3.1 Printhead Specifications .....	203
8.3.2 Ink Sequence .....	203
<b>8.4 Overview .....</b>	<b>204</b>
8.4.1 Troubleshooting according to Panel Messages .....	204
<b>8.5 Parts List for EPSON Stylus Photo R2400 .....</b>	<b>227</b>

CHAPTER

1

# PRODUCT DESCRIPTION

## 1.1 Overview

---

The Stylus Photo R1800 is a photo printer designed for a wide range of users from individual users to commercial users. As a successor to the Stylus Photo 2100/2200, this consumer middle high model is capable of CD-R/DVD-R printing and roll paper cutter functions. This product has the following features.

---

### FEATURES

---

- High color print quality
  - 5760 (H) x 1440 (V) dpi printing (Max resolution)
  - 8 color printing (PPI Black, Photo Black, Cyan, Magenta, Yellow, Red, Violet, Clear)
  - Pigment Ink supported
- Separate Ink Cartridge for each color
- Built-in 2 I/F
  - USB 2.0 (HS compatibility)
  - IEEE 1394
- Windows/Macintosh exclusive
- Roll Paper Support
- Printable area expand (Bottom margin reduce)
- Card printing support
- CD-R printing support

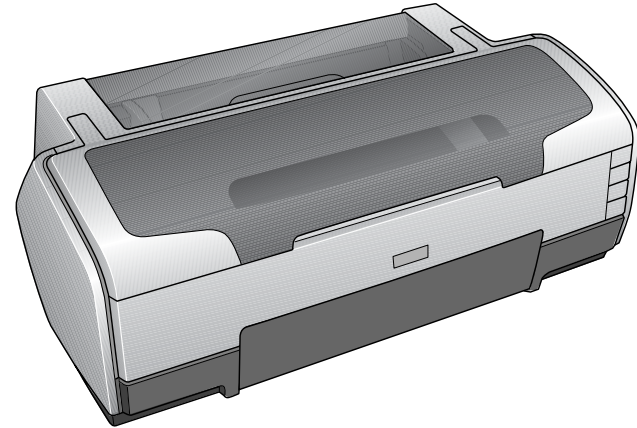

**Figure 1-1. Product Appearance**

## 1.2 PG Setting

As this printer uses an Auto PG (APG), an appropriate PG position is set according to the used paper type.

The following table indicates the PG positions, the main applications of each position, and the relationships between the two sensors used with the APG.

Table 1-1.

Application	PG Position					
	PG (--)	PG (-)	PG (Typ)	PG (+)	PG (++)	Release
Printing	<ul style="list-style-type: none"> <li>PGPP</li> <li>A3</li> <li>A4</li> </ul>	<ul style="list-style-type: none"> <li>Exclusive paper</li> </ul>	<ul style="list-style-type: none"> <li>Plain paper</li> <li>Photo Album paper</li> <li>Photo Matte paper A3 fine</li> <li>PG (-) rub avoidance</li> </ul>	<ul style="list-style-type: none"> <li>Envelope</li> <li>PG (Typ) rub avoidance</li> </ul>	<ul style="list-style-type: none"> <li>CD-R</li> <li>Photo stand paper</li> </ul>	-
Non-printing	-	-	<ul style="list-style-type: none"> <li>Standby position after power-on (For bottom stacker)</li> <li>At power-off</li> <li>The Ink Mark Sensor operates. (Auto Bi-D, Detection of dot missing)</li> </ul>	-	<ul style="list-style-type: none"> <li>Initialization at power-on</li> <li>Cleaning (wiping)</li> <li>Replace the Ink Cartridge</li> </ul>	<ul style="list-style-type: none"> <li>Waiting for CD-R/Board paper to be fed</li> <li>Paper jam removal</li> </ul>
PG value	1.15mm	1.3mm	1.7mm	2.1mm	4.5mm	-
Sensor	PG (--)	PG (-)	PG (Typ)	PG (+)	PG (++)	Release
APG Sensor 1	OFF	OFF	OFF	OFF	OFF	OFF
APG Sensor 2	ON	ON	ON	ON	OFF	OFF

## 1.3 Functions

### 1.3.1 Control Panel

The appearance of the control panel is shown below.

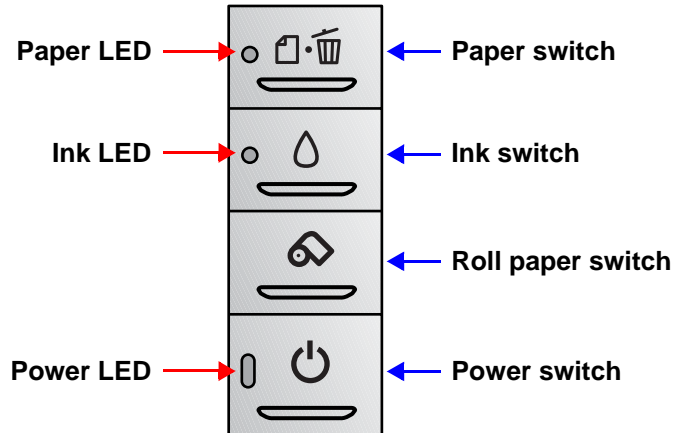

Figure 1-2. Control Panel Appearance

### 1.3.2 Switches

- Power switch
- Paper switch
- Ink switch
- Roll paper switch

### 1.3.3 Indicators

- Power LED : Green
- Paper LED : Red
- Ink LED : Red

### 1.3.4 Switch Functions

#### FUNCTIONS IN NORMAL STATUS

Table 1-2. Normal-status Functions

Switch	Function
Power switch	<ul style="list-style-type: none"> <li>• Power On / Off.</li> <li>• Panel reset (off and on within 10 seconds).</li> </ul>
Paper switch	<ul style="list-style-type: none"> <li>• Loads or Ejects the Paper.</li> <li>• When carriage is on the Ink Cartridge change position, return carriage from Ink Cartridge change position.</li> <li>• In the condition of printing, cancel the print job.</li> </ul>
Ink switch	<ul style="list-style-type: none"> <li>• Starts the Cleaning of head with 3 second pushing.</li> <li>• Moves the carriage to cartridge change position.</li> <li>• When carriage is on the ink change position, return carriage from Ink Cartridge change position.</li> </ul>
Roll paper switch	<ul style="list-style-type: none"> <li>• Loads the Roll paper.</li> <li>• Back out the roll paper with 3 second pushing.</li> <li>• Move to tear off position / Return from tear off position.</li> <li>• When cartridge is on the Ink Cartridge change position, return carriage from Ink Cartridge change position.</li> <li>• When the photo album is used, ejects the paper forwards only. (At this mode, the printer can't move backwards without Top of Form.)</li> </ul>

#### FUNCTION AT POWER-ON

Table 1-3. Power-on Function

Switch	Function
Paper switch	Starts status printings.*1

Note \*1\*: Status printings prints firmware version, ink counter and nozzle check patterns.

### 1.3.5 Indicator Display in Normal Mode

Table 1-4. Printer Condition and LED Status

Printer status	Error status	Indicators			
		Power	Paper	Ink	Priority
Idle	–	On	–	–	20
Data processing	–	Blink	–	–	19
Pause <sup>*1</sup>	Status 05h	–	–	–	18
Ink sequence processing	–	Blink	–	–	17
Ink cartridge change mode	–	Blink	–	–	16
Ink low (warning)	–	–	–	Blink	15
Tear off status	11h	–	–	–	14
Paper mismatch Error	0Ch	–	Fast Blink	–	12
Paper Out	06h	–	On	–	11
Ink end	05h	–	–	On	10
No Ink cartridge or Ink cartridge error	05h	–	–	On	9
Paper Jam Error	04h	–	Blink	–	8
Card loading error	2Ah	–	Blink 2	–	7
Cover Open Tray Error	2Bh	–	Fast Blink	Blink 2	13
Reset input	–	On	On	On	–
Fatal error	00h	Off	Fast Blink	Fast Blink	4
Maintenance request	10h	Off	Blink alternately 1	Blink alternately 2	2
Power off	–	Fast Blink	Off	Off	1

- Note:
- "–" : Don't care
  - Blink : 0.5sec on + 0.5sec off repetition
  - Blink 2 : 0.2sec on + 0.2sec + 0.2sec on + 0.4sec off repetition
  - Fast Blink : 0.1sec on + 0.1sec off repetition
  - Blink alternately 1 : 0.5sec on + 0.5sec off repetition
  - Blink alternately 2 : 0.5sec off + 0.5sec on repetition

Note\*\*1": When the Photo album paper is end, the printer goes to this status.



### 1.3.6 Error Status

If any of the following states is detected, this printer is put in an error status and turns the interface signal -ERROR "Low" and BUSY "High" to inhibit data input. At this time, the printer is automatically disabled from printing. However, when communication is being made using the IEEE1284.4 protocol, communication with the printer is enabled.

- General error  
After the cause of this type of error is removed, the printer can resume its operation from where it stopped due to the error

**Table 1-5. General error**

Error Status	Occurring Condition	Resuming Condition
Cover open (tray) error	When the front cover is opened at ASF, roll paper or photo album printing mode, the printer goes this error.	Close the front cover.
Paper mismatch error	If the paper path specified by the print data is different from the printer's real paper path, the printer goes to this error.	Change the printer's paper path to the one specified by the data.
Paper out	When printer fails to load a sheet, it goes paper out error.	Set the paper to the ASF and push the Paper switch.
Ink out	When the printer runs out the most part of the ink of any one color, it warns ink-low and keeps printing. When the printer runs out the whole ink of any one color, it stops printing and indicates ink-out error.	Install the new Ink Cartridge.
No ink-cartridge	When printer detects that ink-cartridge comes off, it goes this error mode.	Install the new Ink Cartridge.

**Table 1-5. General error**

Error Status	Occurring Condition	Resuming Condition
Paper jam	<ul style="list-style-type: none"> <li>• Failure of ejecting a sheet</li> <li>• Failure of loading a sheet to the loading position</li> </ul>	Remove the jammed paper.
Card loading error	When the card was loaded to the wrong position, the printer goes this error.	Set an A4 paper to the ASF, and press the paper switch. If the card couldn't eject at your first try, repeat again the same method.

- Fatal error  
After the cause of this type of error is removed, the printer cannot return to normal unless it is powered off and then on again

**Table 1-6. Fatal error**

Error Status	Occurring Condition	Resuming Condition
Maintenance request	When the total quantity of ink wasted through the cleanings and flushing is reaches to the limit, printer indicates this error and stops.	Replace the absorber in the printer enclosure by a service person.
Fatal errors	<ul style="list-style-type: none"> <li>• CR motor control error</li> <li>• PF motor control error</li> <li>• ASF motor control error</li> <li>• Auto Platen Gap control error</li> <li>• Head temperature error</li> <li>• PW sensor error</li> </ul>	Turn off and turn on.

## 1.4 Casing Specifications

### EXTERNAL DIMENSIONS

When tucked : 615 (width) x 314 (depth) x 219 mm (height)

When used : 615 (width) x 453 (depth) x 737 mm (height)

### WEIGHT

11.7 kg (without the Ink Cartridges, Roll paper holder and CD-Tray)

### EXTERNAL DIMENSION DIAGRAM

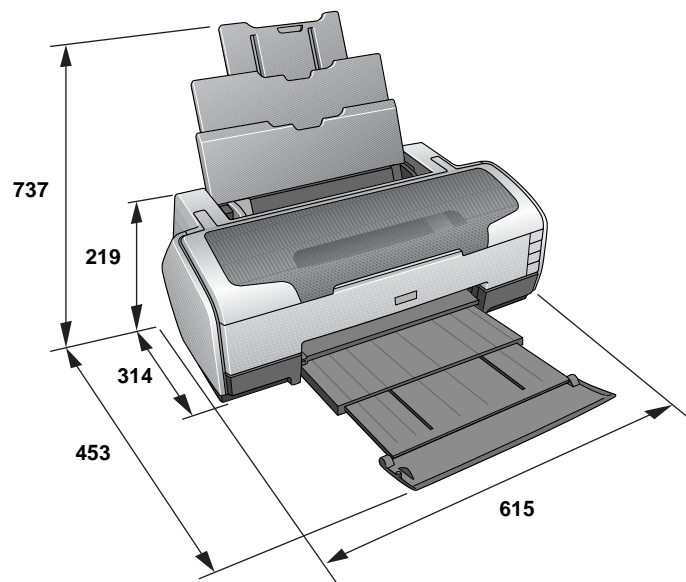

Figure 1-3. External Dimension Diagram

## 1.5 Accessories

### STANDARD ACCESSORIES

- User's guide
- Ink Cartridge (one for each of 8 colors)
- Setup Sheet
- Power Cord
- Software CD-ROM
- CD-R Print Position Check sheet
- Roll Paper Holder
- 8-cm CD/DVD adapter
- CD/DVD tray

### CONSUMABLES AND OPTIONS

- Ink Cartridges
  - Gloss Optimizer : T0540
  - Black : T0541
  - Cyan : T0542
  - Magenta : T0543
  - Yellow : T0544
  - Red : T0547
  - Matte Black : T0548
  - Blue : T0549
- 802.11g Radio printing adapter : PA-W11G

CHAPTER

2

# OPERATING PRINCIPLES

## 2.1 Overview

This chapter explains the operating principles of the mechanical sections and electrical circuits in this product. The main components of this product are as follows.

- Control circuit board : C589 MAIN
- Power supply circuit board : C589 PSB
- Control panel board : C589 PNL
- Control panel B board : C589 PNL-B

## 2.2 Printer Mechanism

Like the conventional model, this product uses DC motors and stepping motors as power sources. The following table describes the motor types and their applications.

Table 2-1. Motors

Motor Name	Type	Applications/Functions
CR Motor	DC motor with brushes	Used for carriage driving. Makes little noise during driving. The CR linear scale and CR encoder sensor are used to control the motor.
PF Motor	DC motor with brushes	Drives the Paper loading rollers at the time of fixed-value paper loading or paper feed/eject operation. To grasp the paper feed pitch, the precision gear surface is fitted with the PF scale and the PF encoder sensor is used to control the motor.
APG Motor	DC motor with brushes	Drives the Carriage Unit at the time of PG setting. The two APG Sensors and Carriage Shaft are driven vertically to control the motor.
ASF Motor	4-phase, 48-pole PM type stepping motor	Drives the paper feed operation of the ASF. Since this is a stepping motor, any scales or photo sensors to know the driving conditions are not required.
Pump Motor	4-phase, 48-pole PM type stepping motor	Drives the pump, wiper, etc. of the Ink System. Since this is a stepping motor, any scales or photo sensors to know the driving conditions are not required.

The basic mechanism is almost same as the Stylus Photo R800. The most major difference is that this Stylus Photo R1800 is equipped with a dedicated sensor to detect a open or close status of the Front Cover. This prevents the Print Head from damaging by mistake. The schematic diagram below shows the printer mechanism.

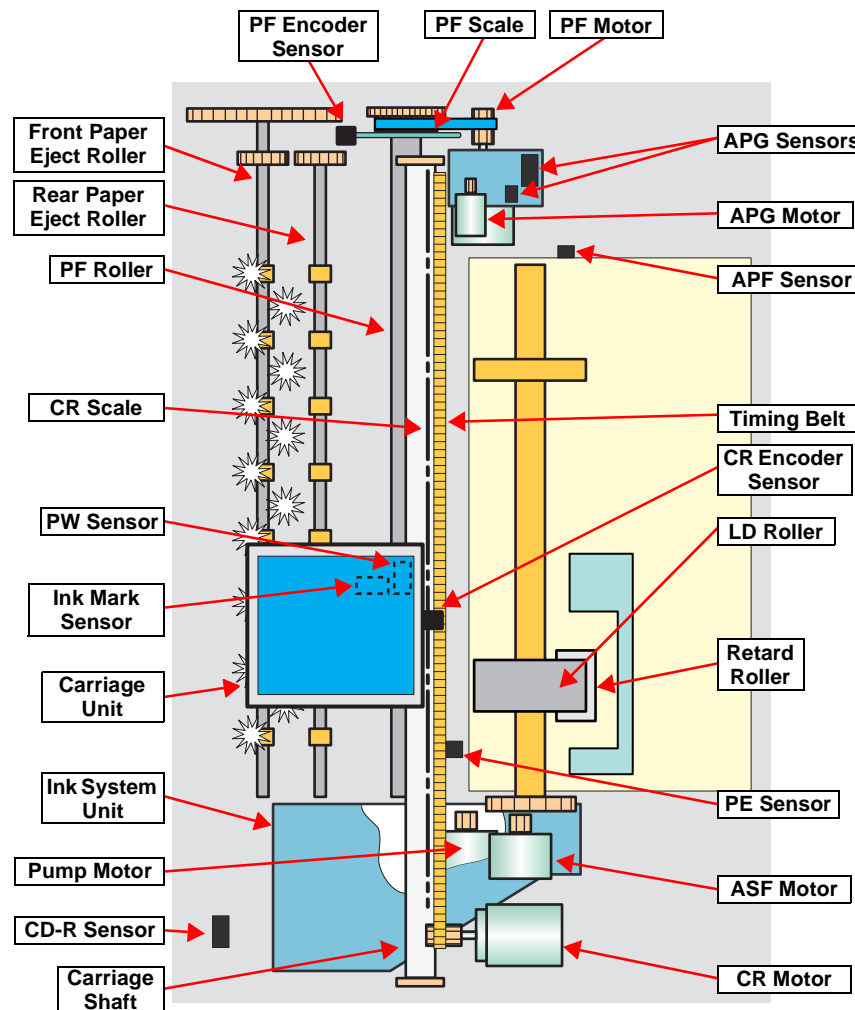

Figure 2-1. Printer Mechanism Outline

## 2.2.1 Carriage Mechanism

The Carriage mechanism consists of the Carriage Motor (CR Motor), Carriage Shafts, Platen Gap Adjustment Mechanism, Carriage Lock Mechanism, and others.

### 2.2.1.1 Carriage Mechanism

The following indicates the specifications of the CR motor (DC motor) that drives the Carriage.

**Table 2-2. CR Motor Specifications**

Item	Specifications
Type	DC motor with brushes
Drive voltage	+42V $\pm$ 5% (voltage applied to driver)
Armature resistance	29.2 $\Omega$ $\pm$ 10%
Inductance	30.0mH $\pm$ 25%
Drive method	PWM, constant-current chopping
Drive IC	A6628

Closed loop control based on the CR Motor (DC Motor) and CR Encoder Sensor has advantages in stabilized print quality and silent operation.

- Heat Generation Control  
The printer has a mechanism to reduce the variations in the torque constant and coil resistance of the DC motors, and variations in output voltage of the Power Supply Board to obtain a designated heating value.
- CR Variation Measurement Sequence  
The variations mentioned above are measured in a CR variation measurement sequence when the CR mechanical load is in the initial status and saved into the EEPROM (A6<H>). According to the saved information, the printer controls the drive voltage to obtain a designated driving current. This minimizes the unit-to-unit variation.

- CR Measurement Sequence  
To set the appropriate drive current value according to the CR mechanical load, the mechanical load is measured in a CR measurement sequence and saved into the EEPROM A4<H>, A5<H> at power-on or after replacement of the Ink Cartridge (s). However, if 6E is saved at the EEPROM A4<H> and 05 at A5<H>, Fatal error will occur since too large load is applied to the CR drive system.

The above control and sequences correct the drive current value of the CR Motor according to not only the mechanical load but also the variations of the motor and like. In addition, the resultant CR drive current value is used to calculate a heating value, and when the specified heating value is reached, wait time is provided per CR path for printing.

### 2.2.1.2 Carriage Home Position Detection

As in the conventional model, the Carriage Home Position is detected using the drive current of the CR Motor and the speed/position signal of the CR Linear Encoder.

The basic home position detection sequence is as described below.

1. The CR linear encoder pulse counter in the CPU is reset by the initialization operation performed at power-on.
2. When the CR Motor rotates counterclockwise, the Carriage Unit moves from left to right. When the following conditions are satisfied, the CPU assumes that the Carriage Unit made contact with the right frame.
  - The ASIC detects 1158/1500 counts or more in the PWM output under CR Motor load positioning control.
  - P1 (number of output pulses from when power is switched on until the Carriage Unit makes contact with the right frame) is 19 steps or less.
3. When the CR Motor rotates clockwise, the Carriage Unit moves from right to left. When the following conditions are satisfied, the CPU assumes that the Carriage Unit reached the CR lock confirmation position.
  - The ASIC detects 575/1500 counts or more in the PWM output under CR Motor load positioning control.
  - A difference between P1 and P2 (number of output pulses from when the Carriage Unit made contact with the right frame until it reaches the Carriage lock confirmation position) is 19 steps or less.
4. When the CR Motor rotates counterclockwise to move the Carriage from left to right and the CPU detects 1158/1500 counts or more in the PWM output under CR Motor load positioning control, the printer judges that the Carriage moved to the far right position (is in contact with the right frame).
5. When a difference between P1 and P3 (number of output pulses from when the Carriage Unit reached the Carriage lock confirmation position until it makes contact with the right frame) is 4 steps or less, the printer judges that the Carriage Unit is in the home position.

The IC14 (ASIC) sets the drive current value adequate for the Carriage Unit motion and outputs it to the motor driver.

Based on the signal output from the IC14 (ASIC), the IC5 (Motor Driver) outputs the CR Motor drive current to the CR Motor.

### 2.2.1.3 Sequence Used for PW Detection

The PW (paper width detection) Sensor installed on the Carriage Unit bottom is used to control the printer according to various sequences.

The following briefly describes the PW Sensor operating principle.

A dark voltage is measured by the PW Sensor in three places at the right flat area (area without the absorber) on the Front Paper Guide every time the printer is turned on, and the measurement values are saved into the EEPROM as threshold values.

- Threshold value  $>$  detection voltage: Paper present
- Threshold value  $<$  detection voltage: Paper absent

The following sequences are performed.

- Detection of Left and Right Edges of Paper and Control
  - Before Printing
 

The printer detects that paper has been loaded. And it sets the print range according to the paper-size information from the Driver and the actual paper-size detected by the PW sensor.
  - During Printing
 

When executing a borderless printing, the printer sets the off-range margins by detecting the paper edges with the PW Sensor. And when the resolution is 1440 x 1440 (VSD3) or 2880 x 1440 (VSD3) dpi, the printer performs the Off-Range Thinning Out Control to make a further correction to the off-range margins.
- Detection of Top Edge of Paper and Control
 

Before starting a print job, the printer detects the top edge of a loaded single sheet of paper, roll paper, or board paper to set the off-range top margin. (Only when not detecting the top edge of paper with the PW Sensor.)
- Detection of Bottom Edge of Paper and Control
 

After starting a borderless printing, the printer sets the off-range bottom margin.
- Detection of Edges of CD-R and Control
 

Before starting to print, the PW Sensor detects top, bottom, left and right edges of the CD-R. [See Section 2.2.3.4 CD-R Printing Mechanism on page 24.](#)

- PW sensor dark voltage (VH) measurement  
 PW sensor dark voltage (VH) measurement is performed at the following timings and locations and used to calculate the threshold value of whether paper is present or not.
    - Cut sheets, Roll paper  
 The dark voltage is measured and updated at every power-on, and the threshold value (VS) is calculated and saved in the EPROM area as a PW detection level.
      - Threshold value > detection voltage: Paper present
      - Threshold value < detection voltage: Paper absent
    - CD-R Tray  
 When printing on a CD-R, the dark voltage is measured on the CD-R tray, and the threshold value (VS) is then calculated and saved in the EPROM area as a PW detection level.
      - Threshold value > detection voltage: CD-R present  
 (tray home position detected)
- The measurement voltage in the presence of the CD-R is saved into the EEPROM as a white level. The white level value is used to check the sensor deterioration condition during servicing or like.
- If the measurement value of the white level is close to that of the PW detection level, it means that the sensor is dirty or deteriorated.

### 2.2.1.4 APG (Auto PG) Mechanism

The following indicates the specification of the DC motor that drives the APG.

Table 2-3. APG Motor Specifications

Item	Specifications
Type	DC motor with brushes
Drive voltage	+42V ± 5% (voltage applied to driver)
Armature resistance	64.7Ω ± 15%
Inductance	37.6mH ± 25%
Drive method	PWM, constant-current chopping
Drive IC	A6628

The APG Motor (DC Motor) and two APG Sensors drive the PG Cam to automatically adjust the PG amount according to the paper.

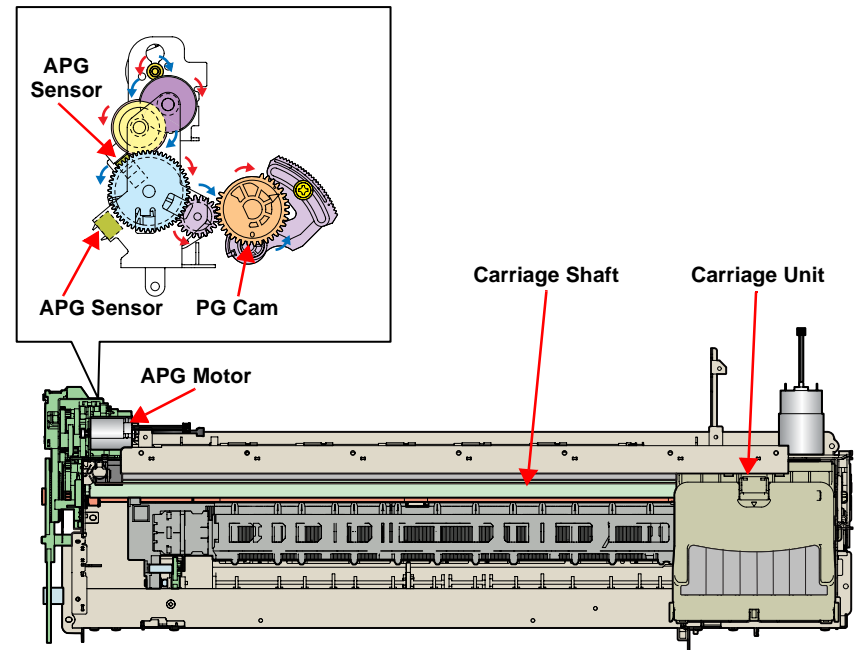

Figure 2-2. APG Mechanism

### 2.2.2 Printhead Specifications

The Printhead of this product is a F-Mach head.  
 The following shows the arrangement of the nozzles and the color arrangement of each nozzle line when viewed the Print Head from behind.

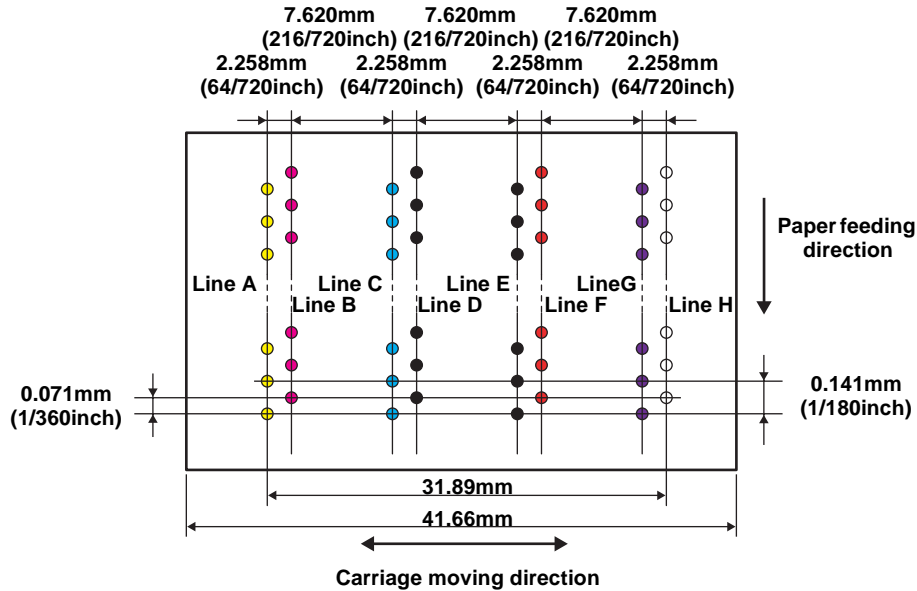

Figure 2-3. Nozzle Arrangement

Table 2-4. Nozzle Lines and the Corresponding Ink Color

Line	Ink
A	Yellow
B	Magenta
C	Cyan
D	Matte-black
E	Photo-black
F	Red
G	Blue
H	Gloss Optimizer

### 2.2.3 Paper Feeding Mechanism

The paper feeding mechanism is a mechanism that feeds paper or CD-R Tray to the PF Roller Shaft.

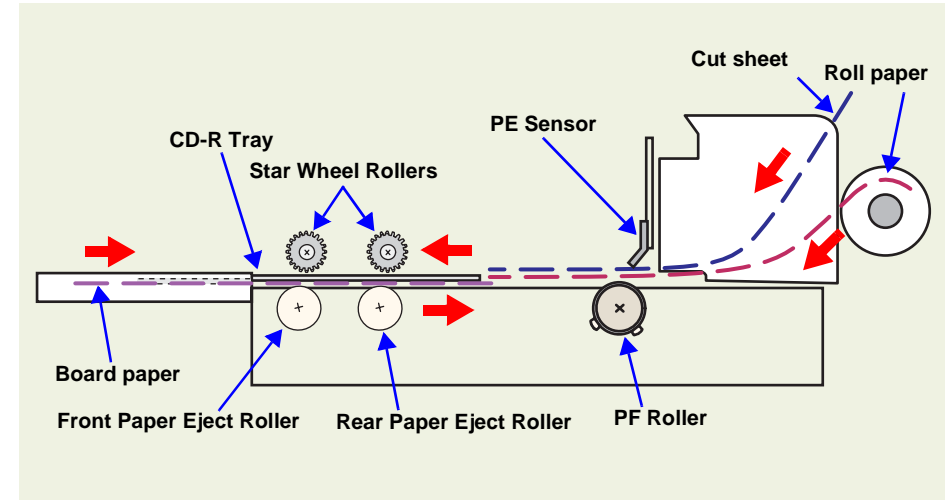

Figure 2-4. Paper Feeding Mechanism



### 2.2.3.1 ASF Paper Feeding Mechanism

The following shows the specifications of the stepping motor that drives the ASF Assy.

**Table 2-5. ASF Motor Specifications**

Item	Specifications
Type	4-phase, 48-pole PM type stepping motor
Drive voltage	+42V $\pm$ 5% (voltage applied to driver)
Winding resistance	7.0 $\Omega$ $\pm$ 10% (per phase at 25°C)
Inductance	10.2mH $\pm$ 20% (1kHz, 1Vrms, 25°C)
Drive method	Bipolar drive/constant-current drive
Drive IC	A6628

Driven by the ASF Motor, the ASF Assy performs the following feeding operation.

1. When a paper feeding command is issued from the PC or the Paper Switch of the panel is pressed after power-on, the driving force of the ASF Motor begins to be transmitted to the LD Roller following the route shown below.

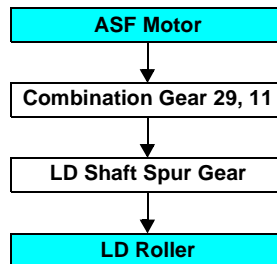

2. When the LD Roller starts rotating, the Flag of the ASF Sensor Wheel comes free from the notch on the ASF Sensor. And at the same time, the Paper Back Lever becomes free from the Cams located at the left and right ends of the LD Roller, then the Paper Holder on the Paper Back Lever inclines downward by tensile force of the Paper Back Lever Torsion Spring.
3. By the LD Roller's rotation, the Hopper is released from the Hopper Cams located at the left and right ends of the LD Roller, and the Hopper pops up by tensile force of the Hopper Compression Spring.

4. When the next sheet of paper is fed by the LD Roller and the Retard Roller, the Hopper is pressed against the Frame again by the Hopper Cams. And the Paper Holder of the Paper Back Lever rises by the Cams at the left and right ends of the LD Roller to prevent the next sheet from being fed with the previous sheet.
5. The LD Roller stops to rotate when it makes one revolution and the Flag of the ASF Sensor Wheel returns to the ASF Sensor.

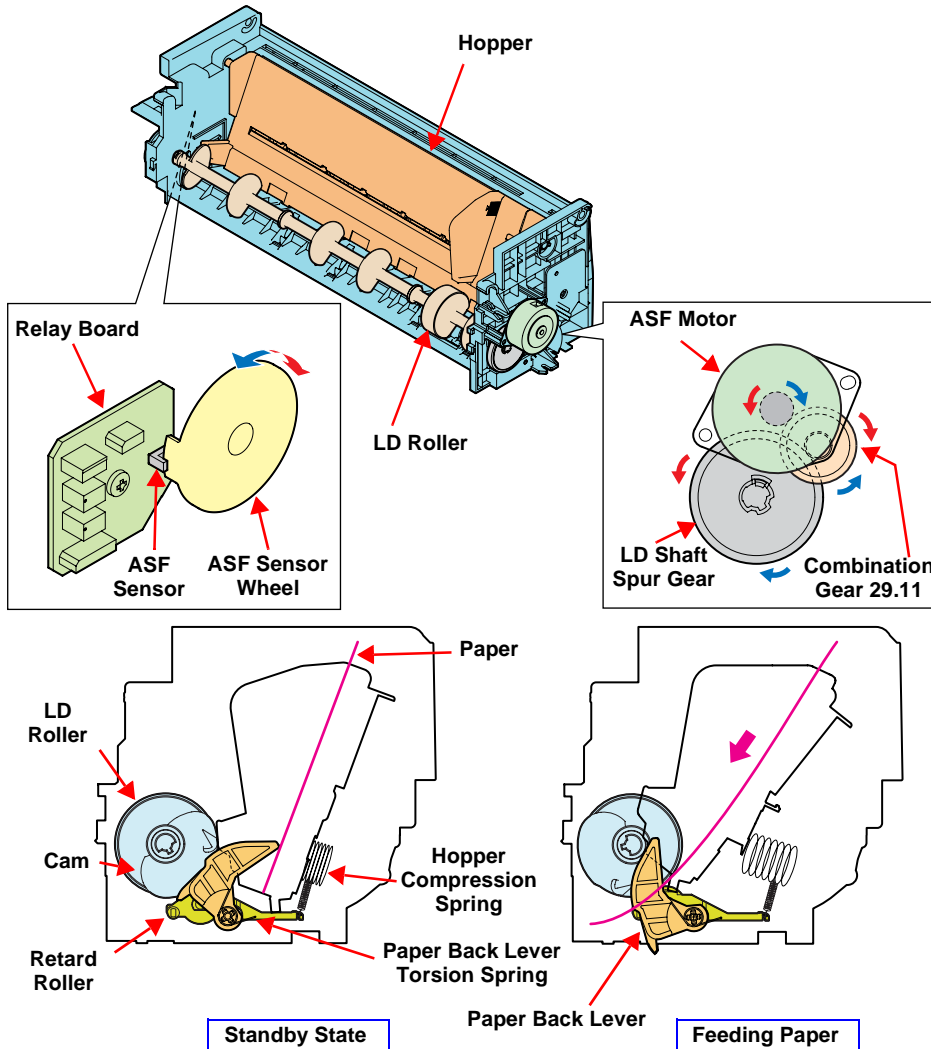

Figure 2-5. ASF Paper Feeding Mechanism

### 2.2.3.2 Roll Paper Feeding

When selecting the Roll Paper Mode, the control Panel switches function in different ways from when printing other than roll paper. This section describes the difference.

1. The roll paper is fed into the printer after a lapse of three seconds from when the PE sensor detects the paper.
2. The roll paper is fed backward to be set at the print position.

While the printer is performing the above operation, the switches are disabled. After the roll paper is set to the print position, the switches operation becomes different from when printing other than roll paper.

The details of the difference are described below.

- When Loading Roll Paper.  
Pressing the Roll Paper Switch for more than 3 seconds feeds the leading edge of the roll paper backward to the PE Sensor (the Paper LED flashes). In this state, draw the roll paper and press the Paper Switch to return the panel operation to the normal mode that enables paper feeding from the ASF.
- When Received a Print Job for Roll Paper
  1. After finished the print job, press the Roll Paper Switch.
  2. A cutoff line is printed, and the roll paper is fed to the roll paper cut position.
  3. After cutting the roll paper with a pair of scissors or like, press the Roll Paper Switch again. This returns the leading edge of the paper to the print starting position.

### 2.2.3.3 CD-R Tray Base Lock Mechanism

To prevent the Print Head from being damaged by mistake, the printer is designed to lock the CD-R Tray Base when the Carriage Unit is out of its home position.

The following explains the lock mechanism of the CD-R Tray Base.

#### □ Lock Release Sequence

1. When the Carriage Unit returns to its home position, the Pump Motor drive is transmitted to the Paper EJ Lock Release Cam.
2. The salient of the Cam presses down the Paper EJ Transmission Lock Lever to release the tab of the Paper EJ Lock Lever from the Paper EJ Transmission Lock Lever.
3. The CD-R Release Lever comes free from the Paper EJ Lock Lever and comes down to enable the CD-R Tray Base to open.

When the Carriage Unit is out of its home position, the salient of the Paper EJ Lock Release Cam does not press down the Paper EJ Transmission Lock Lever, and the tab of the Paper EJ Lock Lever is not released. Therefore, the CD-R Tray Base cannot be opened.

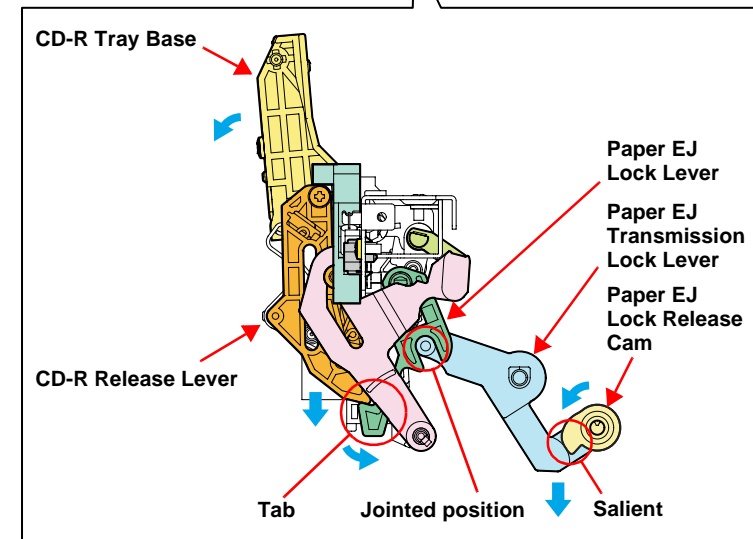
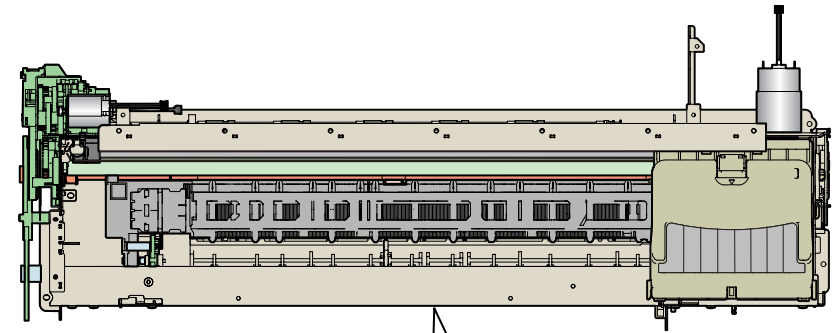

Figure 2-6. CD-R Tray Base Lock Mechanism

### 2.2.3.4 CD-R Printing Mechanism

#### □ CD-R Tray Home Position Detection Sequence

The following sequence is performed after opening the Front Cover (CD-R Sensor closing), inserting the CD-R Tray to the specified position, and pressing the Paper SW.

When the close signal of the CD-R Sensor is detected, no paper is fed from the ASF if the Paper Switch is pressed. In this case, the Paper Switch executes a CD-R Tray home position detection sequence.

1. When the APG Assy is driven, the PG position is set to "++" and the Driven Roller of the Upper Paper Guide presses the CD-R Tray.
2. When the Carriage Unit moves leftward and the PW Sensor detects the CD-R, the Carriage Unit returns to its home position (HP).
3. After waiting for about 5 seconds at the HP, the Carriage Unit moves to the CD-R Tray HP detectable position (right end of the CD-R Tray).
4. The CD-R Tray is pulled in the ASF direction, the PW Sensor detects the CD-R Tray HP, and then the Carriage Unit moves to the center of the CD-R Tray.
5. When the PW Sensor detects the white marking in the center of the CD-R Tray, the CD-R Tray is fed in the paper ejection direction.
6. The Carriage Unit moves leftward, the PW Sensor detects the left side white marking, then the Carriage Unit moves rightward, and the PW Sensor detects the right side white marking.
7. The Carriage Unit moves to the center of the CD-R Tray, and the PW Sensor starts detection in the back-and-forth direction of the CD-R. After the leading edge of the CD-R is detected, the CD-R Tray is fed in the paper ejection direction, and the trailing edge of the CD-R is detected. After that, the CD-R Tray is fed to the center of the CD-R in the paper ejection direction.
8. The Carriage Unit moves leftward, and the PW Sensor starts detection in the horizontal direction of the CD-R. After the left end of the CD-R is detected, the Carriage Unit moves rightward, and the right end of the CD-R is detected.

9. The Carriage Unit moves to the CD-R Tray HP detectable position and stops there, and then the CD-R Tray is fed in the ASF direction.
10. When the CD-R Tray stops operating, the Carriage Unit moves to the carriage HP and stands by.

If the CD-R Tray HP, white marking or CD-R cannot be detected within the steps predetermined for the CD-R Tray HP detection sequence, the CD-R Tray is ejected and Paper Out Error is displayed.

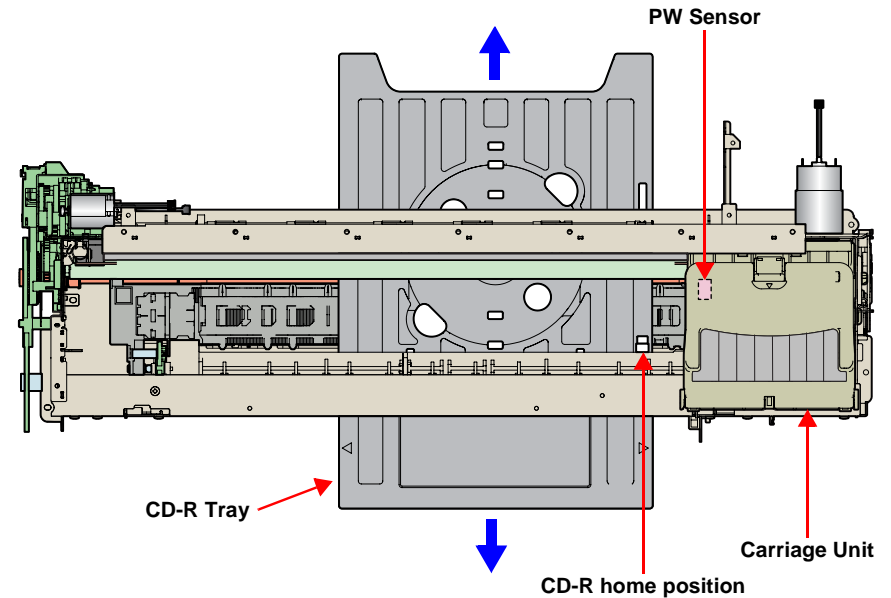

Figure 2-7. CD-R Printing Mechanism

## 2.2.4 Paper Feeding Mechanism

The Paper Feeding Mechanism is designed to transfer the paper fed from the ASF, Roll Paper Guide or Board Paper Guide or the CD-R fed from the CD-R Tray according to the print data.

### 2.2.4.1 Paper Feeding Mechanism

The following shows the specifications of the DC motor that drives the Paper Feeding Mechanism.

Table 2-6. PF Motor Specifications

Item	Specifications
Type	DC motor with brushes
Drive voltage	+42V ± 5% (voltage applied to driver)
Armature resistance	21.2Ω ± 10%
Inductance	17.2mH (1kHz)
Drive method	PWM
Drive IC	A6628

Like the CR Motor, a DC motor is used as the PF Motor in this product.

Closed loop control based on the DC Motor and Rotary Encoder has the following advantages.

- Improved paper feed accuracy
- Paper feed amount control

The PF Motor drive is transmitted to the PF Roller and the Paper EJ Roller following the route shown below. The route is also followed by the paper.

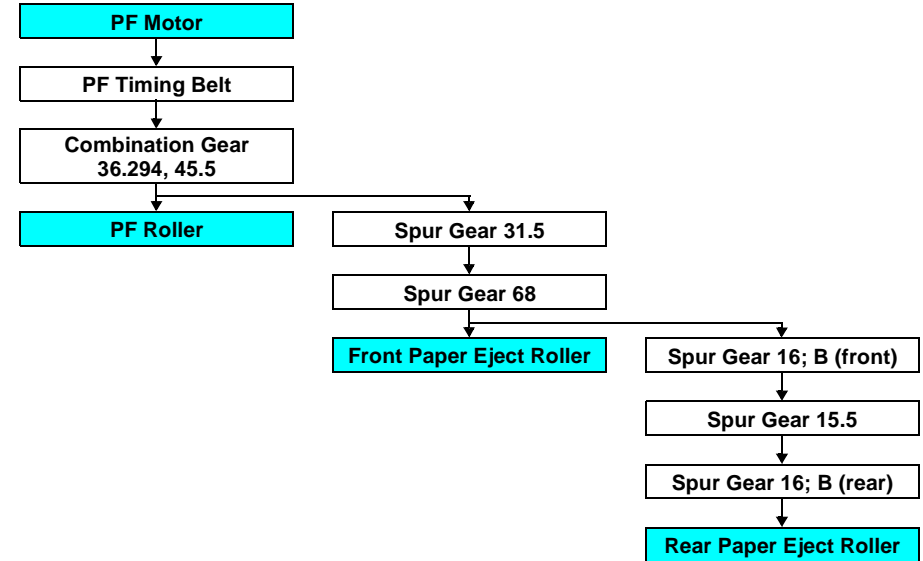

The following shows the part names and outline of the drive transmission path.

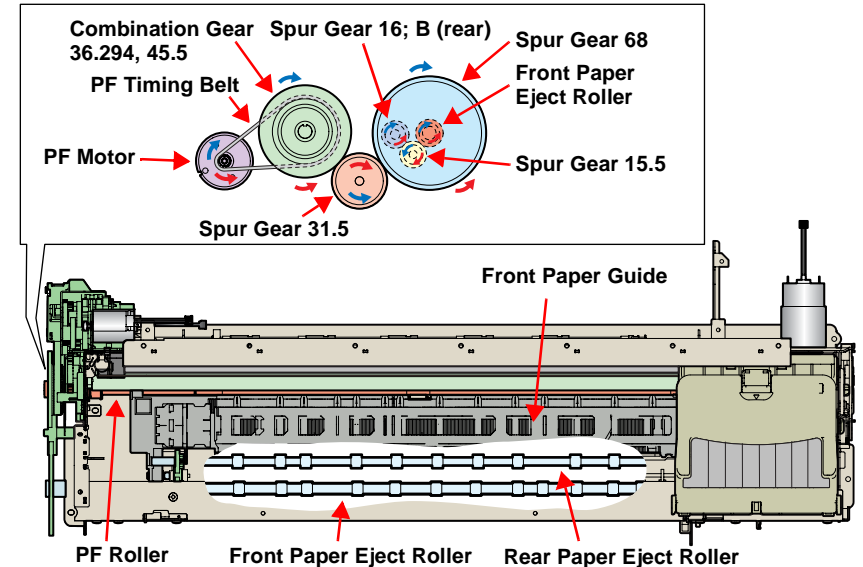

Figure 2-8. Paper Feeding Mechanism

The fed paper is detected by the PE Sensor, and its leading edge is then transferred to the front of the Front Paper Guide.

To eliminate the deflection of the paper, the paper is then returned toward the ASF Assy by the specified number of steps according to the paper feed mode. The paper is transferred again to the specified paper locating position of the Front Paper Guide.

### 2.2.4.2 PF Measurement Sequence

- The mechanical load in the paper feeding path is measured in the following cases to perform control so that an adequate current value is set according to the mechanical load.
  - When power is switched on
  - When the Ink Cartridge is replaced
- When the mechanical load in the paper feeding path reaches the specified value, a Fatal Error is displayed.

## 2.2.5 Ink System Mechanism

The Ink System Mechanism consists of the following units.

- Pump Unit (including the CR Lock Lever)
- Cap Unit

### 2.2.5.1 Pump Unit

The Pump Unit is designed to suck ink from the Print Head or Cap Unit. The Cap Unit has a built-in Head Cleaning Wiper.

The following shows the specifications of the stepping motor that drives Pump Unit.

**Table 2-7. Pump Motor Specifications**

Item	Specifications
Type	4-phase, 48-pole PM type stepping motor
Drive voltage	+42V ± 5% (voltage applied to driver)
Winding resistance	10.3Ω ± 10% (per phase at 25°C)
Inductance	13.4mH ± 20% (1kHz, 1Vrms)
Drive method	Bipolar drive/constant-current drive
Drive IC	A6628

The following operations are performed when the drive of the Pump Motor is transmitted to the Pump Unit.

**Table 2-8. Pump Motor Rotation Directions and Functions**

Pump Motor Rotation Direction*	Functions
CW direction	<ul style="list-style-type: none"> <li>• Cap closing</li> <li>• Ink suction</li> <li>• Wiper resetting</li> <li>• CR Lock setting</li> </ul>
CCW direction	<ul style="list-style-type: none"> <li>• Cap opening</li> <li>• Pump release</li> <li>• Wiper setting</li> <li>• CR Lock resetting</li> </ul>

Note "\*": The direction (CW or CCW) was determined viewing the motor from the output shaft of the motor mounting plate.

### 2.2.5.2 Drive Transmission Path to Pump Unit

The drive of the Pump Motor is transmitted to the Pump Unit in the following path.

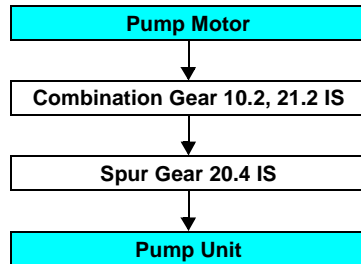

The following shows the internal part names and operation outline of the Pump Unit.

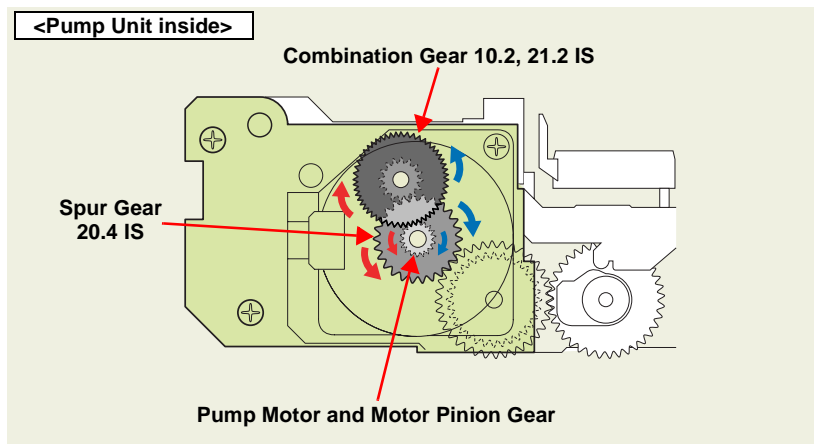

Figure 2-9. Outline of Pump Unit Inside

The following shows the Pump Unit operating principle.

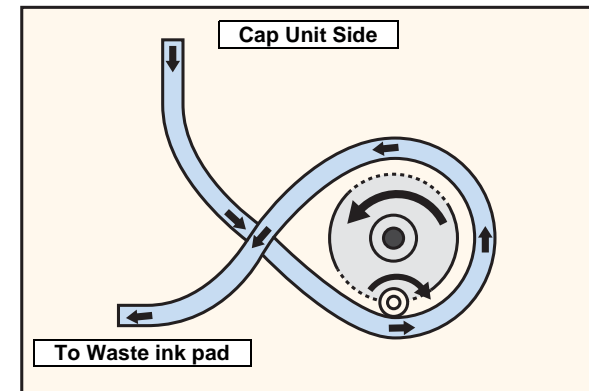

Figure 2-10. Pump Unit Operating Principle

#### □ Ink Suction

1. The Pinion Gear of the Pump Motor rotates in the CW direction.
2. The Roller turns and simultaneously presses the tube.
3. Ink is fed from the Cap Unit toward the Waste Ink Pad.

#### □ Pump Release

1. The Pinion Gear of the Pump Motor rotates in the CCW direction.
2. The Roller moves away from the tube and releases the tube.
3. Ink is not sucked.

### 2.2.5.3 Cap Unit

The Cap Unit is designed to make airtight in the Cap sticking fast to the Print Head surface so that ink suction can be performed by the driving force of the Pump Unit.

When the printer is in a standby status or its power is OFF, the Cap Unit prevents the ink from thickening.

The following figures shows the Cap Unit operation.

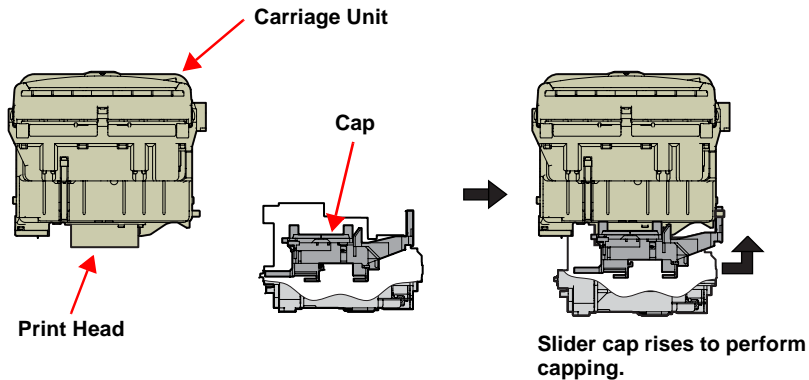

Figure 2-11. Capping Mechanism

### 2.2.6 Ink Sequence

The following ink sequence is executed according to various timer, counter, flag and other information saved on the EEPROM.

#### □ CSIC-related sequence

The ink type code stored in the CSIC Memory Chip is saved in the Main Board EEPROM. At power-on, data is read from each color CSIC and the CSIC data status becomes valid. If the data read from each CSIC has any problem, No Ink Cartridge, CSIC Error or Ink Out will be displayed. After CSIC operation is checked, the ink consumption of the I/C currently installed per color is compared with the ink consumption saved in the printer EEPROM, and control is performed under the following conditions.

- When the current ink consumption data differs between the Ink Cartridge and the EEPROM
  1. The printer judges that the Ink Cartridge was replaced while the printer was turned off. Then it resets the 1st I/C flag in the EEPROM.
  2. The printer updates the number of times the CSIC is installed.
  3. After incrementing the counter of I/C replacement, the printer reads the ink consumption data from the CSIC to write it over the existing data in the EEPROM following the CSIC data replacement sequence.
  4. The printer model name data on the CSIC is rewritten.

Note: The reason why the model name data is rewritten from the printer to the CSIC is to know for which model was the I/C used at the time of collecting used I/Cs.

  5. The replacement flag 2 (flag that indicates CL after Replacement) is set and the CL is executed.



- When the current ink consumption data in the Ink Cartridge and that in the EEPROM is same
  1. When the initial filling flag is set and the CSIC ink consumption is 0, the printer judges that initial filling is not yet performed. (The printer before initial filling judges that the I/C is fitted in a power-off status.)
  2. Installation count updating, CSIC information rewriting, and initial filling are executed in that order.
  3. If the initial filling flag is not set, the printer judges that I/C(s) has not been replaced during power-off and regards the current CSIC data as valid.

Data is written to the CSIC at the following timings.

- At power-off
- When starting the power saving mode
- When replaced an Ink Cartridge(s)
- At the time of cleaning
  1. Reads the data from the CSIC.
  2. Compare the date with the ink consumption data in the EEPROM.
  3. If the EEPROM data is same as the CSIC data, ends the sequence. If they differ, the difference is added to write the sum in the CSIC.

- Initial Ink Filling
 

When the printer is powered on for the first time after purchase, the printer executes the initial ink filling operation to fill the ink cavities of the Head with ink. When the initial ink filling operation is performed properly, the printer clears the flag in the EEPROM so that initial ink filling operation will not be performed when it is powered on the next time. The Stylus Photo R1800 requires about 160 seconds to perform the initial ink filling operation.

If the sequence does not end normally during initial filling, the initial filling flag is not cleared and the CL operating flag is set. Because of these flags, when powered on the next time, the printer assumes that it was powered off for some reason during initial filling and executes CL3 instead of the initial filling sequence. (On the conventional mode, initial filling was executed again. However, when this operation was performed, ink was wasted and therefore CL3 is executed to cover the ink filling performance.)

When the initial filling flag is set and the CL operating flag is not set, the printer judges that the initial filling was not executed at all (power was switched on but the cartridges were not installed), and when the printer is powered on the next time, it executes initial filling.
- Replacement Cleaning
 

Replacement CL1 is executed when replaced an Ink Cartridge(s).

  - Amount of Ink Suction
 

Replacement CL1: 3.09g (0.386g per color)

#### □ Manual Cleaning

This printer provides three different manual cleanings to remove ink coagulated by air bubbles, viscous material or foreign matter. Perform the following manual CL operations by operating the panel or using the utility included in the printer driver.

Independently of the printing path after the previous CL, perform manual CL from CL1 to CL3 in order if the cumulative printing timer counter is less than 7min. Only when the cumulative printing timer counter is more than 7min, execute only CL1.

##### ■ Amount of Ink Suction

- CL1: 1.55g (0.194g per color)
- CL2: 4.08g (0.510g per color)
- CL3: 6.47g (0.809g per color)

##### ■ Wiping Operation

Clean the nozzle surface with the right-half rubber part of the wiper.

##### ■ Flushing Operation

Prevent color mixture. Stabilize the ink surface inside the nozzles.

In addition, the printer determines which CL to perform according to the remaining amount of ink in the Cartridge. When the printer detects the amount is low, it automatically choose the CL that uses ink less than the other CLs. If the remaining amount of ink is extremely low (Ink Low or Ink Out status), the printer disables the all manual Cleanings and indicates the status on the EPW3.

#### □ Timer Cleaning

Ink is consumed depending on the combination of the cumulative printing timer, cumulative cleaning count and cleaning timer.

#### □ Flushing

There are two types of flushing.

##### ■ Flushing before printing

This is performed to reduce the viscosity of ink in the Print Head nozzles before starting to print.

##### ■ Scheduled Flushing

This is performed to prevent ink in the Print Head nozzles from increasing its viscosity during printing.

## 2.2.7 Power-On Sequence

The following describes the printer operation after it is powered on.

### When the Carriage Unit is in the Home Position with the CR Locked

1. After power-on, the drive of the APG Motor is transmitted to the Carriage Shaft, and the PG position changes from PG Typ. to PG++.
2. The drive of the CR Motor is transmitted to the Carriage Unit, and the Carriage Unit performs HP detection operation in the following path.
  - Home position ⇒ Right frame ⇒ CR Lock confirmation position ⇒ Right frame ⇒ Home position
3. The drive of the Pump Motor is transmitted to the Cap Unit, the Cap opens (lowers), and the CR Lock is released.
4. After the Carriage Unit has moved leftward by the specified number of steps, the Wiper, driven by the Pump Motor, performs the following.
  - Wiper setting ⇒ Wiper resetting
5. The Carriage Unit returns to the home position, and the PG position returns from PG++ to PG Typ.
6. The drive of the PF Motor is transmitted to the PF Roller and Paper Eject Rollers (front and rear), which then rotate for about 2 seconds.
7. After moving between the left and right frames twice, the Carriage Unit moves to the right end of the Front Paper Guide.
8. The PF Roller and Paper Eject Rollers (front and rear) rotate.
  - Rotation for about 4 seconds (slow speed) ⇒ Rotation for about 2 seconds
9. The Carriage Unit returns to the home position and is secured by the CR Lock.

**When the Carriage Unit is Out of the Home Position**

1. When the PG position is other than PG++ after power-on, the drive of the APG Motor is transmitted to the Carriage Shaft, and the PG position changes to PG++.
2. The drive of the CR Motor is transmitted to the Carriage Unit, and the Carriage Unit returns to the home position at slow speed.
3. The drive of the PF Motor is transmitted to the PF Roller and Paper Eject Rollers (front and rear), which then rotate for about 2 seconds.
4. After the Carriage Unit has moved leftward by the specified number of steps, the Wiper is set, driven by the Pump.
5. After the Carriage Unit has returned to the home position, it moves leftward again by the specified number of steps. And, driven by the Pump Motor, ink is sucked for about 4 seconds and then the Wiper is set, and the CR Lock is placed.
6. The Carriage Unit performs HP detection operation in the following path.
  - Home position ⇒ Right frame ⇒ CR Lock confirmation position ⇒ Right frame ⇒ Home position
7. The drive of the Pump Motor is transmitted to the Cap Unit, the Cap opens (lowers), and the CR Lock is released.
8. The Carriage Unit returns to the home position, and the PG position returns from PG++ to PG Type.
9. The PF Motor drive is transmitted to the PF Roller and the Paper EJ Rollers (front and rear) to rotate them for about 2 seconds.
10. The Step 7 to 9 of *"When the Carriage Unit is in the Home Position with the CR Locked (p30)"* are performed, and the Carriage Unit is locked.

**2.3 Electrical Circuit Operating Principles**

The electrical circuit of Stylus Photo R1800 consists of the following circuits.

- Control circuit board : C589 MAIN
- Power supply circuit board : C589 PSB
- Control panel board : C589 PNL
- Control panel B board : C589 PNL-B

The following shows how the four circuit boards are connected.

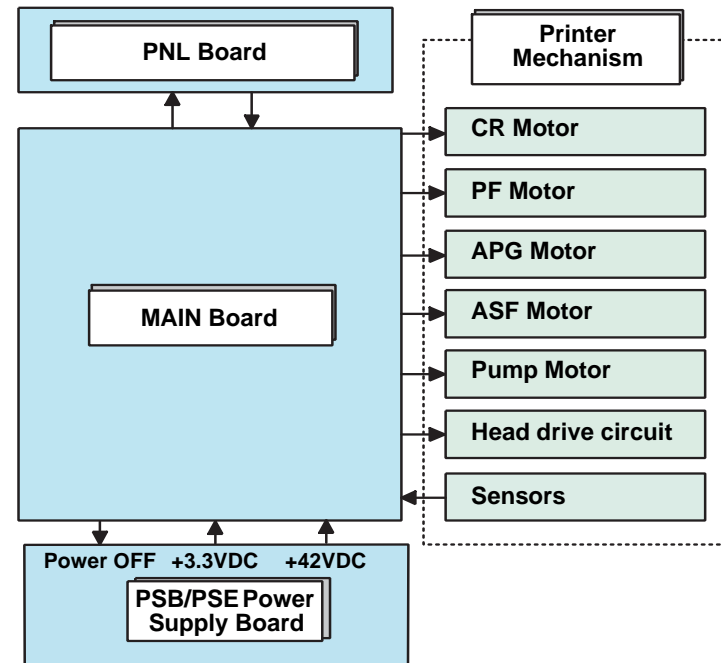

Figure 2-12. Electrical Circuit Block Diagram

### 2.3.1 Power Supply Circuit Operating Principle

The power supply circuit board of this product is the C589 PSB.

- Basic circuit structure
  - Flyback switching system
  - +42VDC and +3.3VDC are supplied to the Printer Mechanism and Control Board

The following indicates the applications of the voltages generated in this power supply circuit.

**Table 2-9. Supplied Power**

Voltage	Applications
+42VDC Rated output current: 0.45A	<ul style="list-style-type: none"> <li>• CR Motor</li> <li>• PF Motor</li> <li>• PG Motor</li> <li>• ASF Motor</li> <li>• Pump Motor</li> <li>• Head drive voltage</li> </ul>
+3.3VDC Rated output current: 0.5A	<ul style="list-style-type: none"> <li>• Logic sensor circuit</li> <li>• Sensor circuit</li> <li>• Nozzle selection circuit (on the Print Head)</li> <li>• Interface control circuit</li> </ul>

The following is the block diagram of the power supply circuit.

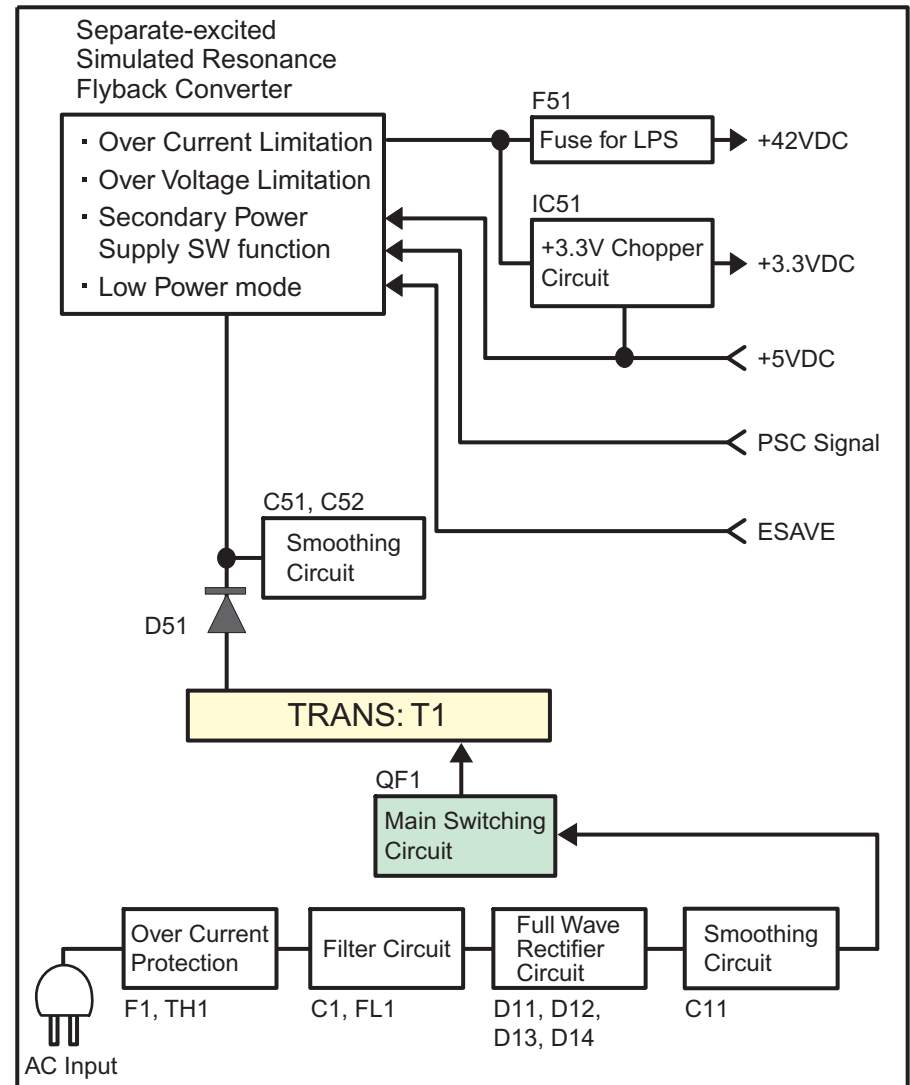

**Figure 2-13. Power Supply Circuit Block Diagram**

## 2.3.2 C589 MAIN Circuit Operating Principle

The C589 MAIN Board consists of the following circuits and sensors.

- Logic Circuits (CPU-ASIC 2 in 1, PROM, SDRAM)
- Circuits for controlling and driving Motors  
(CR Motor, PF Motor, APG Motor, ASF Motor, Pump Motor)
- Circuits for controlling and driving the Head
- Interface Circuits  
USB 2.0, IEEE1394
- Sensor Circuits
- RTC Circuit
- DAC Converter Circuit
- Low-power Circuit
- Logic Circuit Element for 3.3V/1.5V

The +3.3VDC generated on the C589 PSB Board is transformed to +1.5V by the Regulator IC on the C589 Main Board to use it to drive multiple components.

This transformation is performed to reduce power consumption of the Logic Circuit.

The following components operate with the 3.3V/1.5V.

- CR Encoder Sensor
  - PF Encoder Sensor
  - PW Sensor
  - Ink Mark Sensor
  - APG Sensor
  - PE Sensor
  - ASF Sensor
- Complex Circuit (IC18)  
The Complex Circuit (IC18) that consists of EEPROM, RTC, and Reset circuit is installed on the printer. Employing a large-capacity condenser for the Timer allows to backup the time recorded at power-off for about a week after the power-off.

The following is the block diagram of the C589 MAIN control board.

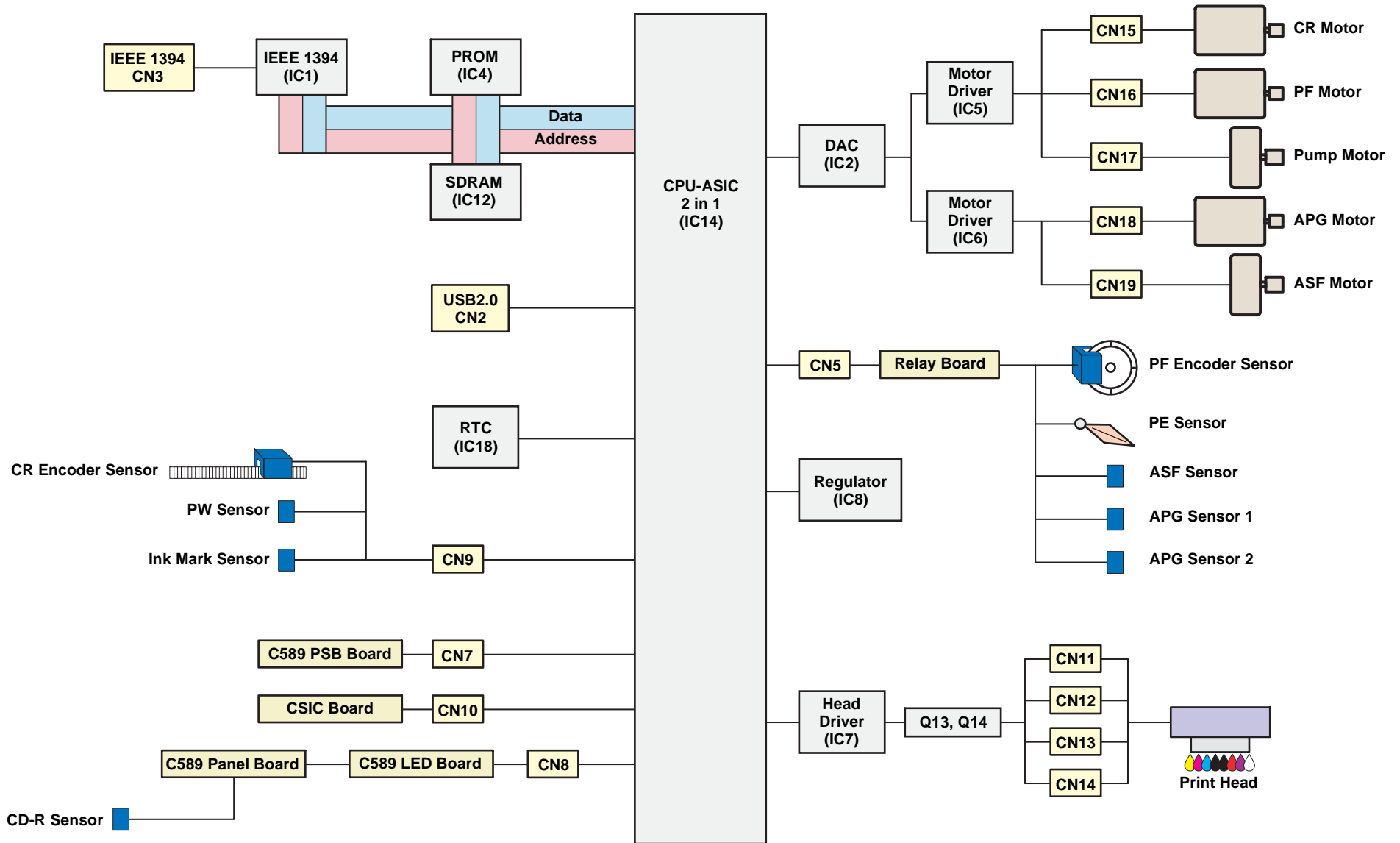

Figure 2-14. C589 MAIN Control Board Block Diagram

CHAPTER

3

# TROUBLESHOOTING

## 3.1 Overview

This chapter describes unit-level troubleshooting.

### 3.1.1 Troubleshooting according to Panel Messages

After checking the printer LED and EPW3 error indications, you can grasp the fault location using the check list in this section. When you find the fault location, refer to Chapter 4 "Disassembly and Reassembly" and change the corresponding part and/or unit. The following table indicates the check point reference tables corresponding to the error states (LED and EPW3).

**Table 3-1. Reference Tables of Error States**

<b>Error State</b>	<b>Reference Table</b>
Communication Error	<a href="#">Refer to Table 3-2 "Troubleshooting of Communication Error" on page 37</a>
Model Difference	<a href="#">Refer to Table 3-2 "Troubleshooting of Communication Error" on page 37</a>
Cover Open (Tray) Error	<a href="#">Refer to Table 3-3 "Troubleshooting of Cover Open Error" on page 40</a>
Paper Out Error	<a href="#">Refer to Table 3-4 "Troubleshooting of Paper Out Error" on page 40</a>
Paper Jam Error	<a href="#">Refer to Table 3-5 "Troubleshooting of Paper Jam Error" on page 44</a>
Card Loading Error	<a href="#">Refer to Table 3-6 "Troubleshooting of Card Loading Error" on page 45</a>
Paper Mismatch Error	<a href="#">Refer to Table 3-7 "Troubleshooting of Paper Mismatch Error" on page 46</a>
Ink Low	<a href="#">Refer to Table 3-8 "Troubleshooting of Ink Low" on page 46</a>
Ink Out Error	<a href="#">Refer to Table 3-9 "Troubleshooting of Ink Out Error" on page 46</a>
No Ink Cartridge/CSIC Error	<a href="#">Refer to Table 3-10 "Troubleshooting of No Ink Cartridge/Ink Cartridge Error" on page 47</a>
Maintenance Request Error	<a href="#">Refer to Table 3-11 "Troubleshooting of Maintenance Request" on page 49</a>
Fatal Error	<a href="#">Refer to Table 3-12 "Troubleshooting of Fatal Error" on page 50</a>



Table 3-2. Troubleshooting of Communication Error



Occurrence Timing	Phenomenon Detail	Faulty Part/ Part Name	Check Point	Remedy
At power-on	The printer does not operate at all.	Panel FFC	1. Check that the Panel FFC is connected to the Panel Board Connector and LED Board Connector. 	1. Connect the Panel FFC to the Panel Board and LED Board connectors.
			2. Check the Panel FFC for damages.	2. Replace the Panel FFC with a new one.
		Panel Board	1. Check the Panel Board for damages.	1. Replace the Panel Board with a new one.
		LED FFC	1. Check that the LED FFC is connected to the LED Board Connector and Main Board Connector CN8. 	1. Connect the LED FFC to the LED Board Connector and Main Board Connector CN8.
			2. Check the LED FFC for damages.	2. Replace the LED FFC with a new one.

Table 3-2. Troubleshooting of Communication Error

Occurrence Timing	Phenomenon Detail	Faulty Part/ Part Name	Check Point	Remedy
<p>At power-on</p>	<p>The printer does not operate at all.</p>	<p>Power Supply Board</p>	<p>1. Check that the Connector Cable of the Power Supply Board is connected to the Main Board Connector CN7.</p>	<p>1. Connect the Connector Cable of the Power Supply Board to the Main Board Connector CN7.</p>
				
			<p>2. Check that the blue colored pin of the Power Supply Board Connector cable is inserted into the 1 Pin of the Main Board Connector CN7 as shown in the above picture.</p>	<p>2. Reconnect the Power Supply Board Connector cable so that the blue colored pin is inserted into the 1 Pin.</p>
			<p>3. Check that the Fuse F1 on the Power Supply Board has not blown.</p>	<p>3. Replace the Power Supply Board with a new one.</p>
				
			<p>4. Check the components on the Power Supply Board for damage.</p>	<p>4. Replace the Power Supply Board with a new one.</p>

Table 3-2. Troubleshooting of Communication Error

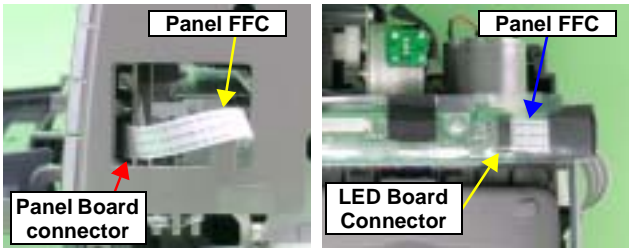
Occurrence Timing	Phenomenon Detail	Faulty Part/ Part Name	Check Point	Remedy
At power-on	After the power-on sequence has started, the LED turns off and the printer does not operate.	Main Board	1. Check that the Relay connector of the ASF Motor and the Relay connector of the Pump Motor are not connected to the wrong connector causing a short circuit.  	1. Connect the Relay Connector of the ASF Motor and the Relay Connector of the Pump Motor correctly, and replace the Main Board with a new one.
At operation	Operation at power-on is normal, but the error appears when the print job is sent to the printer.	Interface cable	1. Check that the Interface cable is connected between the PC and printer.	1. Connect the Interface cable to the PC and printer.
			2. Check the Interface cable for breaking.	2. Replace the Interface cable with a new one.
		EPSON USB driver	1. When using USB, check that the EPSON USB driver has been installed on the PC.	1. Install the EPSON USB driver.
		USB	1. Check that the PC and printer are connected via the USB hub.	1. Enter the USB serial No. indicated on the product nameplate. Refer to Chapter 5 " <i>Adjustment</i> ".
		IEEE1394	1. Check that the same code as the IEEE1394 QR label code is saved in the EEPROM address (from BA-H to BE-H).	1. Input the code given as the IEEE1394 QR label code. Refer to Chapter 5 " <i>Adjustment</i> ".
		Printer Driver	1. Check that the printer driver for Stylus Photo R1800 has already been installed.	1. Install the printer driver for Stylus Photo R1800.
	2. Check that the connected printer is Stylus Photo R1800.	2. Connect the Stylus Photo R1800 printer.		
Main Board	1. Check that a wrong model name has not been input to the EEPROM address (E0<H>) on the Main Board.	1. Using the Adjustment Program, enter the correct model name (save 01 into E0<H>). Refer to Chapter 5 " <i>Adjustment</i> ".		

Table 3-3. Troubleshooting of Cover Open Error

Occurrence Timing	Phenomenon Detail	Faulty Part/ Part Name	Check Point	Remedy
During printing	A Cover Open (Tray) Error is indicated during printing.	Printer Cover	1. Check that the CD-R Unit is not open.	1. Close the CD-R Unit.

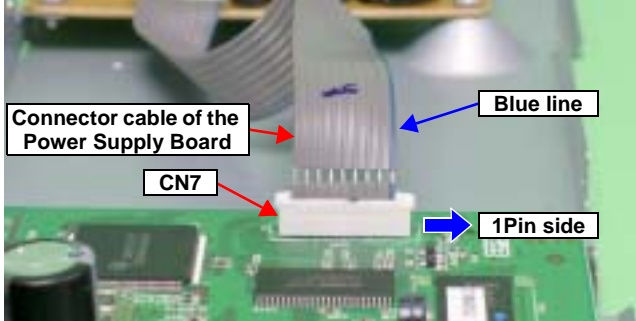
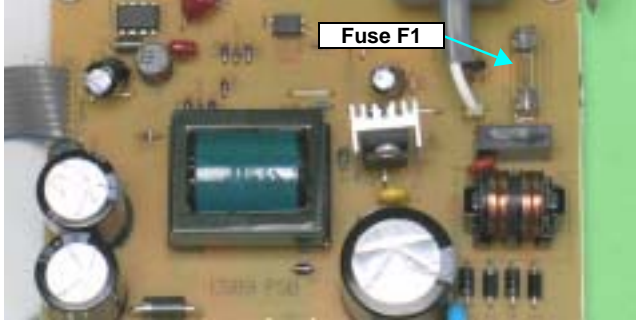
Table 3-4. Troubleshooting of Paper Out Error

Occurrence Timing	Phenomenon Detail	Faulty Part/ Part Name	Check Point	Remedy
At operation	When the Paper Switch is pressed, the LD Roller attempt to feed paper but the paper is not fed.	ASF Assy.	1. Check the LD Roller or Retard Roller of the ASF Assy for paper dust and foreign matter.	<p>1. Using a cleaning sheet (part code:1262115), clean the LD Roller and Retard Roller. The procedure is as follows.</p> <ol style="list-style-type: none"> <li>Place the cleaning sheet upside down and put it into the ASF Assy.</li> <li>Press the Paper Switch to start paper feed.</li> <li>Repeat the above steps several times.</li> </ol> <p>* To remove persistent contamination, staple an alcohol-dampened cloth to a postcard and clean the rollers in the following method.</p> <div style="display: flex; justify-content: space-around; align-items: flex-start;"> <div style="text-align: center;"> <p><b>Cleaning sheet</b></p>  </div> <div style="text-align: center;"> <p><b>Postcard used as mount</b></p>  </div> </div> <ol style="list-style-type: none"> <li>Place the alcohol-dampened cloth toward the LD Roller surface of the ASF Assy.</li> <li>Hold the mount top end securely and press the Paper Switch.</li> <li>Repeat the paper feed sequence several times to clean the LD Roller surface of the ASF Assy.</li> </ol>

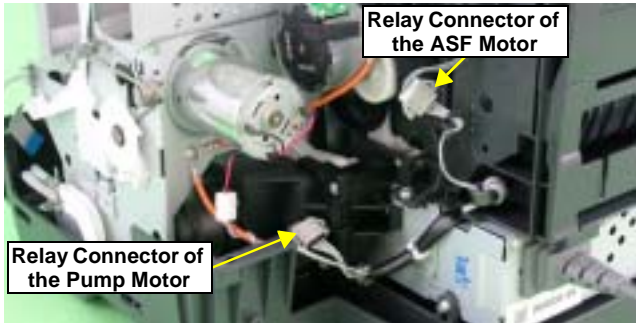
Table 3-4. Troubleshooting of Paper Out Error

Occurrence Timing	Phenomenon Detail	Faulty Part/ Part Name	Check Point	Remedy
At operation	Though paper is fed from the ASF Assy, it stops near the PE Sensor Lever.	PE Sensor	1. Check that the Connector cable of the PE Sensor is securely connected to the PE Sensor and Relay Board Connector CN2. <div style="display: flex; justify-content: space-around; margin-top: 10px;"> <div style="text-align: center;">  <p>PW Sensor Connector</p> </div> <div style="text-align: center;">  <p>CN2</p> </div> </div>	1. Connect the Connector cable of the PE Sensor to the PE Sensor and Relay Board Connector CN2.
			2. Check that the Sensor Holder is mounted to the Mechanical frame correctly. <div style="text-align: center; margin-top: 10px;">  </div>	2. Install the Sensor Holder correctly.
			3. Move the Detection Lever manually as when the paper passes, and check that the Detection Lever returns to the original position automatically by the Torsion Spring when released. Refer to the above photo.	3. Replace the PE Sensor Holder Unit with a new one.
			4. Using a tester, check that the PE Sensor is normal. <ul style="list-style-type: none"> <li>· Paper absent : 2.4V or more</li> <li>· Paper present : 0.4V or less</li> </ul>	4. Replace the PE Sensor Holder Unit with a new one.

Table 3-4. Troubleshooting of Paper Out Error

Occurrence Timing	Phenomenon Detail	Faulty Part/ Part Name	Check Point	Remedy
<p>The Paper Switch was pressed at the setting of the CD-R Tray.</p>	<p>The CD-R Tray HP detection sequence stops and the Tray is ejected.</p>	<p>CD-R Tray</p>	<p>1. Check the HP detection position or white markings of the CD-R Tray for paper dust and foreign matter.</p>  <p>The diagram shows a top-down view of a CD-R tray. A blue arrow points to a small white square on the right side labeled 'HP detection position'. Two yellow circles highlight white markings on the left side, with a label 'White Markings' pointing to them.</p>	<p>1. Remove paper dust and/or foreign matter from the detection position.</p>
			<p>2. Check the Driven Roller surface for contamination such as paper dust and CD-R coating material.</p>	<p>2. Feed A4-size sheets of plain paper from the ASF Assy several times to remove the contamination.</p>
			<p>3. Check that the HP detection position or white markings of the CD-R Tray are not chipped.</p>	<p>3. Replace the CD-R Tray with a new one.</p>
<p>The Paper Switch was pressed at the setting of the CD-R Tray or board paper</p>	<p>Though the CD-R Tray or the Board Paper is fed toward the ASF Assy, but is ejected immediately.</p>	<p>PW sensor</p>	<p>1. Check the PW Sensor for paper dust, ink, etc.</p>  <p>The image shows the bottom of a carriage unit. A blue arrow points to a small component labeled 'PW sensor'. A label 'Carriage Unit Bottom' is at the bottom left.</p>	<p>1. Clean the PW Sensor surface.</p>
			<p>2. Compare the EEPROM values in two places (50&lt;H&gt; and 51&lt;H&gt;) and check that they are not approximate to each other.</p>	<p>2. Replace the PW Sensor with a new one.</p>

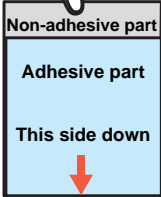
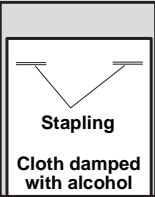
Table 3-4. Troubleshooting of Paper Out Error

Occurrence Timing	Phenomenon Detail	Faulty Part/ Part Name	Check Point	Remedy
<p>The Paper Switch was pressed at the setting of the CD-R Tray or board paper</p>	<p>The CD-R Tray moves toward the ASF and the posterior edge of it reaches to the Driven Roller on the Upper Paper Guide. Then the CD-R Tray tries to go farther, but it is ejected.</p>	<p>PW sensor</p>	<p>1. Check that the PW Sensor FFC is placed in the specified routing positions and does not make contact with any parts.</p>	<p>1. Place the PW Sensor FFC in the specified routing positions.</p>
				
			<p>2. Check that the PW Sensor FFC is connected to the CR Encoder Board and PW Sensor Connectors. Refer to the above photo.</p>	
<p>3. Check the PW Sensor or PW Sensor FFC for damages.</p>	<p>3. Replace the PW Sensor with a new one.</p>			

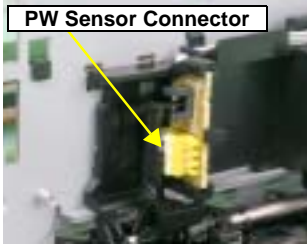
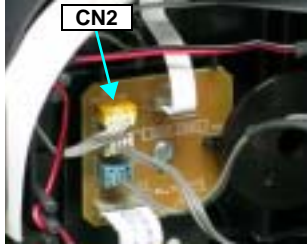
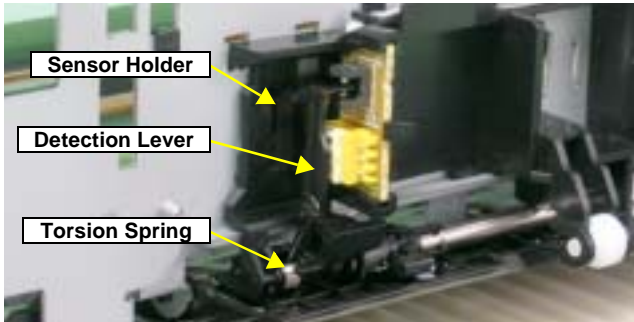
Table 3-5. Troubleshooting of Paper Jam Error

Occurrence Timing	Phenomenon Detail	Faulty Part/ Part Name	Check Point	Remedy
At operation	At the time of paper ejection, the PF Roller advances the paper but cannot eject it completely.	-	1. Check that the size of the fed paper is not larger than that of the paper specified by the driver.	1. Tell the user that the paper size specified by the driver is not available for the printer.
	Paper is not ejected completely and causes a jam near the Paper Eject Frame.	ASF Assy.	1. Check that the paper is fed along the Right Edge Guide.	1. Feed the paper along the Right Edge Guide.
		Paper EJ Frame Assy.	1. Check that the Star Wheel Units have not come off the Paper EJ Frame Assy. 	1. Securely install the Star Wheel Units to the Paper EJ Frame Assy.
			2. Check the Paper EJ Frame Assy for deformation or damages.	2. Replace the Paper EJ Frame Assy with a new one.
		Spur Gear 68 Spur Gear 16; B Paper EJ Roller Assy.(front/rear)	1. Check the Spur Gear 68 or Spur Gear 16; B for damages. 	1. Replace the Front (or Rear) Paper EJ Roller Assy with a new one.

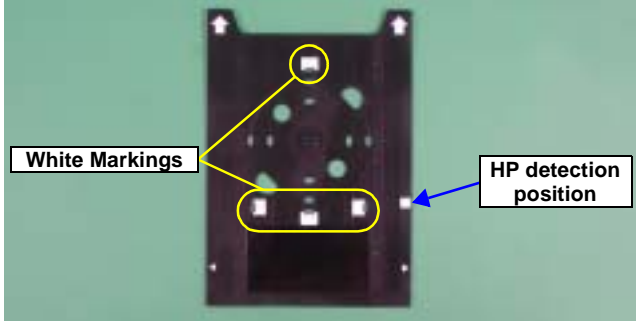
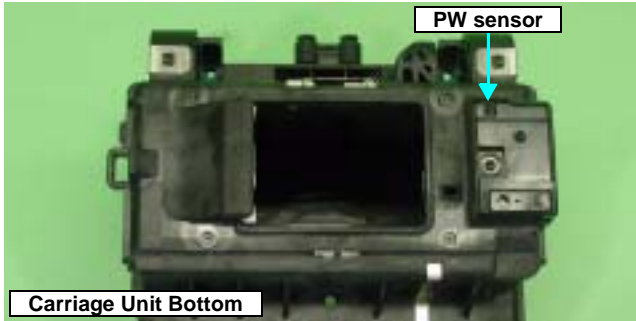

Table 3-6. Troubleshooting of Card Loading Error

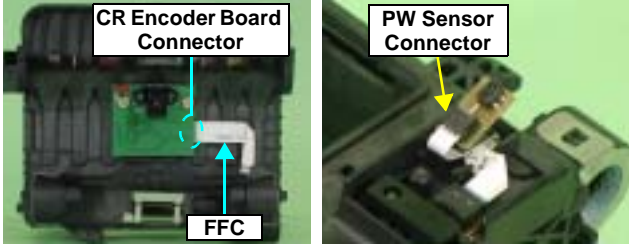
Occurrence Timing	Phenomenon Detail	Faulty Part/ Part Name	Check Point	Remedy
During printing	Printing starts but paper is not fed.	-	1. Check that the card size paper is loaded in the portrait orientation.	1. Load the cards of the same size correctly, and press the Paper Switch to eject the jammed paper.
	The card size paper is loaded correctly, but Card Loading Error is displayed.	PW sensor	1. Check that the PW Sensor FFC is connected to the CR Encoder Board and PW Sensor Connectors. <div data-bbox="868 454 1500 699" style="display: flex; justify-content: space-around; margin-top: 10px;">   </div> 2. Check the PW Sensor or PW Sensor FFC for damages.	1. Connect the FFC to the CR Encoder Board or PW Sensor.  2. Replace the PW Sensor with a new one.

**Table 3-7. Troubleshooting of Paper Mismatch Error**

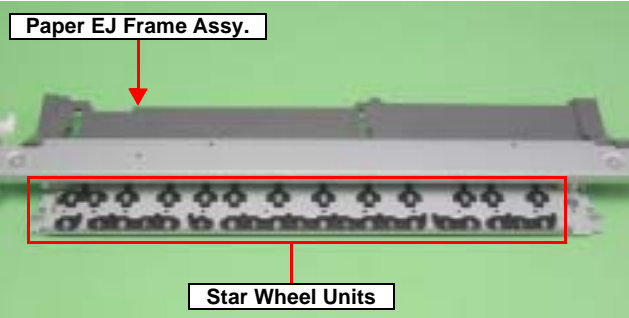
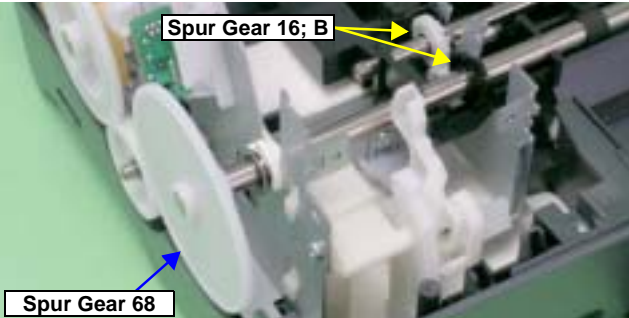
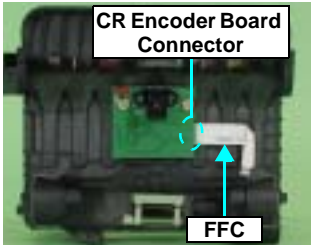
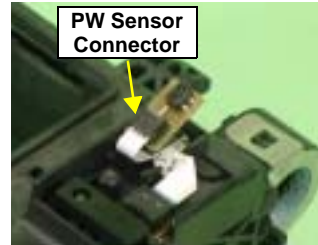
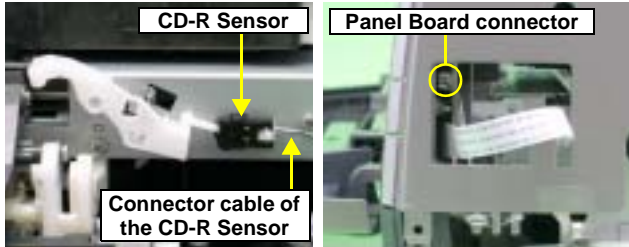
Occurrence Timing	Phenomenon Detail	Faulty Part/Part Name	Check Point	Remedy
At operation	When feeding a CD-R (Board Paper), an error is displayed on the LED and EPW3.	Paper EJ Frame Assy (CD-R Tray Base)	1. Check if the CD-R Tray Base is closed or not.	1. Open the CD-R Tray Base.
		CD-R Sensor	1. Check that the Connector cable of the CD-R Sensor is securely connected to the connectors of the CD-R Sensor and Panel Board. 	1. Connect the Connector cable of the CD-R Sensor to the CD-R Sensor and Panel Board Connectors.
			2. Check the CD-R Sensor or Connector cable for damages.	2. Replace the CD-R Sensor with a new one.

**Table 3-8. Troubleshooting of Ink Low**

Occurrence Timing	Phenomenon Detail	Faulty Part/Part Name	Check Point	Remedy
At operation or during printing	A message is displayed on the LED and EPW3 during printing.	Ink Cartridge	1. Look at the remaining ink indication of the EPW3 to check the amount of the ink remaining in the Ink Cartridge.	1. Prepare a new Ink Cartridge.

**Table 3-9. Troubleshooting of Ink Out Error**

Occurrence Timing	Phenomenon Detail	Faulty Part/Part Name	Check Point	Remedy
During printing	After the Carriage has detected the HP, an error is displayed on the LED and EPW3.	Ink Cartridge	1. Look at the remaining ink indication of the EPW3 to check whether the ink remains in the Ink Cartridge.	1. Replace the Ink Cartridge with a new one.

Table 3-10. Troubleshooting of No Ink Cartridge/Ink Cartridge Error



Occurrence Timing	Phenomenon Detail	Faulty Part/ Part Name	Check Point	Remedy
At power-on	After the Carriage has detected the HP, an error is displayed on the LED and EPW3.	Ink Cartridge	1. Check that the Ink Cartridge is installed correctly.	1. Install the Ink Cartridge correctly.
			2. Check that the tab of the Ink Cartridge is not broken.	2. Replace the Ink Cartridge with a new one.
				
3. Check that the Memory Chip is not disconnected or not damaged.	3. Replace the Ink Cartridge with a new one.			
				

Table 3-10. Troubleshooting of No Ink Cartridge/Ink Cartridge Error

Occurrence Timing	Phenomenon Detail	Faulty Part/ Part Name	Check Point	Remedy
At power-on	After the Carriage has detected the HP, an error is displayed on the LED and EPW3.	CSIC FFC	1. Check that the CSIC FFC is connected to the CSIC Board Connector and Main Board Connector CN10. 	1. Connect the CSIC FFC to the CSIC Board Connector and Main Board Connector CN10.
			2. Check the CSIC FFC for damage.	2. Replace the CSIC FFC with a new one.
		CSIC Board	1. Check the CSIC Board for damage. 	1. Replace the CSIC Board with a new one.
Carriage Unit	1. Check that the electrodes in the Carriage, which make contact with the CSIC Board, are not bent. 	1. Replace the Carriage Unit with a new one.		

Table 3-11. Troubleshooting of Maintenance Request

Occurrence Timing	Phenomenon Detail	Faulty Part/ Part Name	Check Point	Remedy
At power-on	At power-on, the printer does not operate at all.	Waste Ink Pads	1. Using the Adjustment Program, check if the Protection Counter A+B value has exceeded 17772.	1. Replace the Waste Ink Pads and reset the Protection Counter A and B value with the Adjustment Program. <ul style="list-style-type: none"> <li>• Home side: 24&lt;H&gt;, 25&lt;H&gt;</li> <li>• Opposite-to-home side: 26&lt;H&gt;, 27&lt;H&gt;</li> </ul>

Table 3-12. Troubleshooting of Fatal Error

Occurrence Timing	Phenomenon Detail	Faulty Part/ Part Name	Check Point	Remedy
At power-on	At power-on, the CR Motor does not operate at all.	CR Motor	1. Check that the CR Motor connector cable is connected to the Relay Connector. 	1. Connect the CR Motor connector to the Relay Connector.
		2. Check the CR Motor connector cable for damages.	2. Replace the CR Motor with a new one.	
		3. Check if the CR Motor operates normally.	3. Replace the CR Motor with a new one.	
		Relay Connector Cables (for the CR Motor)	1. Check that the Relay Connector Cable is connected to the Main Board Connector CN15. 	1. Connect the Relay Connector Cable to the Main Board Connector CN15.
		2. Check the Relay Connector Cable for damages.	2. Replace the Relay Connector Cable with a new one.	

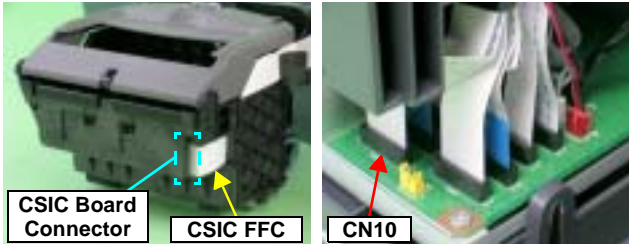
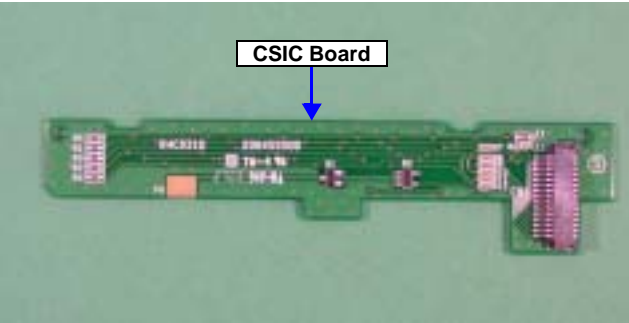
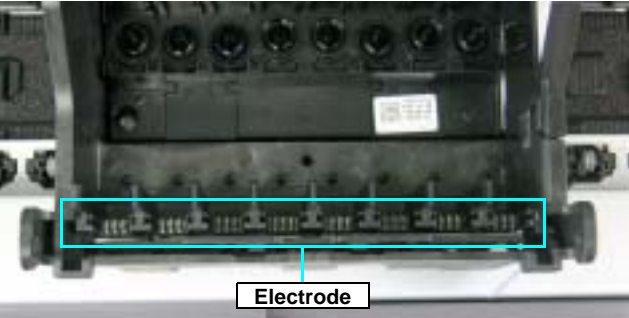
Table 3-12. Troubleshooting of Fatal Error

Occurrence Timing	Phenomenon Detail	Faulty Part/ Part Name	Check Point	Remedy
At power-on	The power-on sequence is executed but Fatal error is displayed.	CR drive mechanism	1. Check that the Carriage Shaft is lubricated with grease. 	1. Wipe the surface of the Carriage Shaft with a dry, soft cloth, and lubricate the Carriage Shaft with grease G-71. Refer to Chapter 6 " <i>Maintenance</i> ".
	At power-on, the PF Motor does not operate at all.	PF Motor	1. Check that the Connector Cable of the PF Motor is connected to the Main Board Connector CN16. 	1. Connect the PF Motor connector cable to the Main Board Connector CN16.
			2. Check the PF Motor connector cable for damages.	2. Replace the PF Motor with a new one.
			3. Check if the PF Motor operates normally.	3. Replace the PF Motor with a new one.

Table 3-12. Troubleshooting of Fatal Error

Occurrence Timing	Phenomenon Detail	Faulty Part/ Part Name	Check Point	Remedy
At power-on	At power-on, the APG Motor does not operate at all.	APG Motor	1. Check that the Connector Cable of the APG Motor is connected to the Main Board Connector CN18.	1. Connect the APG Motor connector cable to the Main Board Connector CN18.
				
			2. Check the APG Motor connector cable for damage.	
3. Check if the APG Motor operates normally.	3. Replace the APG Motor with a new one.			
At power-on, the Pump Motor does not operate at all.		Pump Motor	1. Check that the Pump Motor connector cable is connected to the Relay Connector.	1. Connect the Pump Motor connector cable to the Relay Connector.
				
			2. Using a tester, check the resistance value of the Pump Motor. Value of resistance : $10.3\Omega \pm 10\%$	
3. Check the Pump Motor connector cable for damages.	3. Replace the Ink System Unit with a new one.			

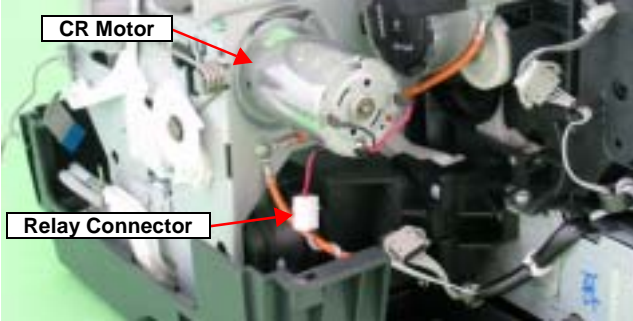
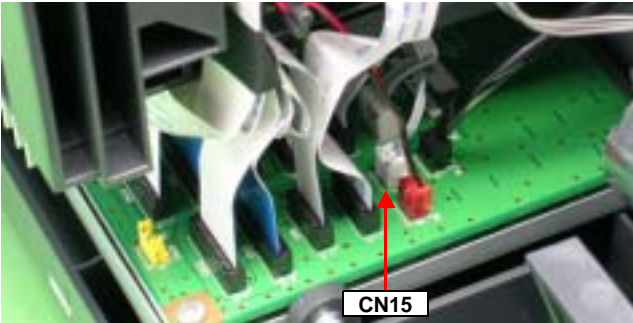

Table 3-12. Troubleshooting of Fatal Error

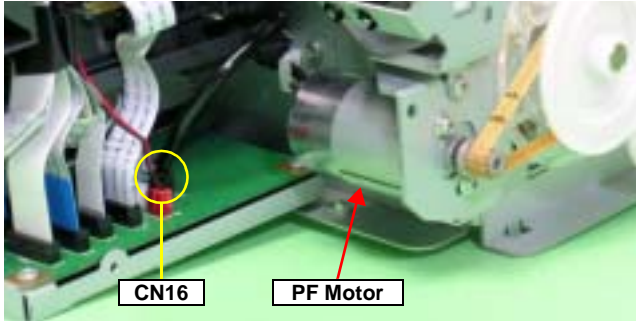
Occurrence Timing	Phenomenon Detail	Faulty Part/ Part Name	Check Point	Remedy
At power-on	At power-on, the Pump Motor does not operate at all.	Relay Connector Cables (for Pump Motor)	1. Check that the Relay Connector Cable is connected to the Main Board Connector CN17. 	1. Connect the Relay Connector Cable to the Main Board Connector CN17.
			2. Check the Relay Connector Cable for damages.	2. Replace the Relay Connector Cable with a new one.
	While the power-on sequence is being executed, Fatal error is displayed.	APG Sensor	1. Check that the APG Sensor Connector cables are connected to the APG Sensors and Relay Board Connector CN4 and CN5. 	1. Connect the APG Sensor Connector cables to the APG Sensors and Relay Board Connector CN4 and CN5.
			2. Check the APG Sensors for damages.	2. Replace the APG Sensors with new ones.

Table 3-12. Troubleshooting of Fatal Error

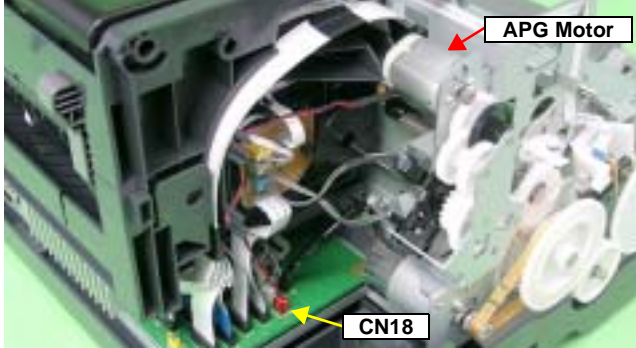
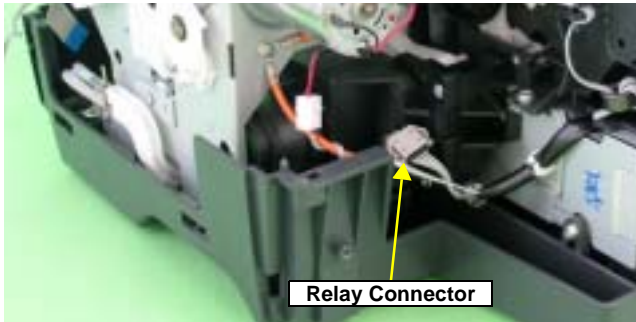
Occurrence Timing	Phenomenon Detail	Faulty Part/ Part Name	Check Point	Remedy
At power-on	While the power-on sequence is being executed, Fatal error is displayed.	ASF Motor	<ol style="list-style-type: none"> <li>1. Check that the Connector cable of the ASF Motor is connected to the Relay Connector.</li> </ol>  <ol style="list-style-type: none"> <li>2. Using a tester, check the resistance value of the ASF Motor. Value of resistance : <math>7.0\Omega \pm 10\%</math></li> <li>3. Check the ASF Motor connector cable for damages.</li> </ol>	<ol style="list-style-type: none"> <li>1. Connect the Connector cable of the ASF Motor to the Relay Connector.</li> <li>2. If the resistance value is abnormal, replace the ASF Motor with a new one.</li> <li>3. Replace the ASF Motor with a new one.</li> </ol>
		Relay Connector Cable (for the ASF Motor)	<ol style="list-style-type: none"> <li>1. Check that the Relay Connector Cable is connected to the Main Board Connector CN19.</li> </ol>  <ol style="list-style-type: none"> <li>2. Check the Relay Connector Cable for damages.</li> </ol>	<ol style="list-style-type: none"> <li>1. Connect the Relay Connector Cable to the Main Board Connector CN19.</li> <li>2. Replace the Relay Connector Cable with a new one.</li> </ol>

Table 3-12. Troubleshooting of Fatal Error

Occurrence Timing	Phenomenon Detail	Faulty Part/ Part Name	Check Point	Remedy
At power-on	While the power-on sequence is being executed, Fatal error is displayed.	Relay FFC	1. Check that the Relay FFC is connected to the Relay Board Connector CN1 and Main Board Connector CN5. 	1. Connect the Relay FFC to the Relay Board Connector CN1 and Main Board Connector CN5.
			2. Check the Relay FFC for damages.	2. Replace the Relay FFC Cable with a new one.
	At power-on, the Carriage Unit moves away from the home position and bumps against the right of the Frame, then hits the left of the Frame.	CR Scale	1. Check that the CR Scale is inserted in the slit of the CR Encoder Sensor. 	1. Insert the CR Scale into the slit of the CR Encoder Sensor.
			2. Check the CR Scale for damages and dirt.	2. Wipe off the dirt completely or replace the CR Scale with a new one.
		CR Encoder Sensor Board	1. Check the CR Encoder Sensor for paper dust, etc.	1. Remove the paper dust, etc. from the CR Encoder Sensor.
2. Check the CR Encoder Sensor Board for damages.	2. Replace the CR Encoder Sensor Board with a new one.			

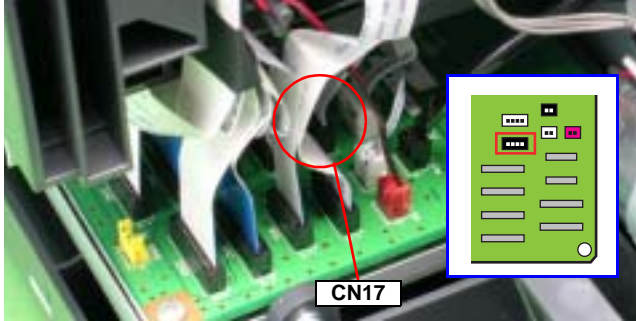
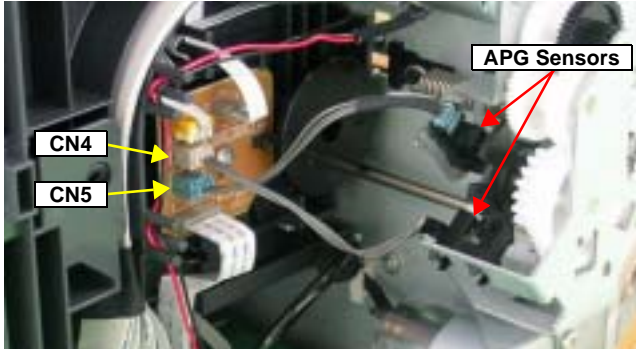
Table 3-12. Troubleshooting of Fatal Error

Occurrence Timing	Phenomenon Detail	Faulty Part/ Part Name	Check Point	Remedy
At power-on	At power-on, the Carriage Unit moves away from the home position and bumps against the right of the Frame, then hits the left of the Frame.	Sensor FFC	1. Check that the Sensor FFC is connected to the CR Encoder Sensor Board Connector and Main Board Connector CN9.	1. Connect the Sensor FFC to the CR Encoder Sensor Board Connector and Main Board Connector CN9.  2. Replace the Sensor FFC with a new one.
				
At power-on, the PF Roller rotates fast about a half turn.		PF Encoder Sensor Holder	1. Check that the PF Encoder Sensor Holder is mounted correctly.	1. Install the PF Encoder Sensor Holder correctly.
			2. Check that the FFC of the PF Encoder Sensor is securely connected to the PF Encoder Sensor Board Connector and Relay Board Connector CN6.	2. Connect the PF Encoder Sensor FFC to the PF Encoder Sensor Board and Relay Board Connector CN6.
				
			3. Check the PF Encoder Sensor for paper dust, etc.	3. Remove the paper dust, etc. from the PF Encoder Sensor.
4. Check if the PF Encoder or the FFC is damaged.	4. Replace the PF Encoder with a new one.			

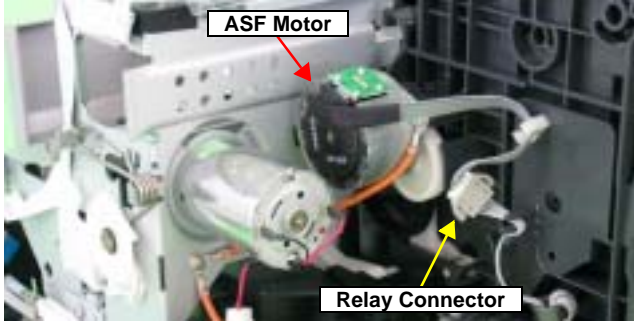
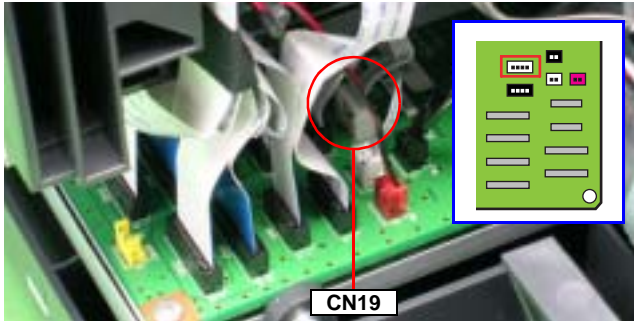
Table 3-12. Troubleshooting of Fatal Error

Occurrence Timing	Phenomenon Detail	Faulty Part/ Part Name	Check Point	Remedy
At power-on	At power-on, the PF Roller rotates fast about a half turn.	PF Scale	1. Check that the PF Scale is inserted in the slit of the PF Encoder Sensor.	1. Install the PF Scale in the slit of the PF Encoder Sensor correctly.
				
During printing	After receiving a print data, or while performing the CD-R Tray home position detection sequence (Board Paper detection), an error is displayed on the LED and EPW3.	Head FFC Sensor FFC	1. Check that the Head FFC and the Sensor FFC are securely connected to the Main Board Connectors CN9 through CN14.	1. Connect the Head FFC and the Sensor FFC to the Main Board Connectors CN9 through CN14.
				

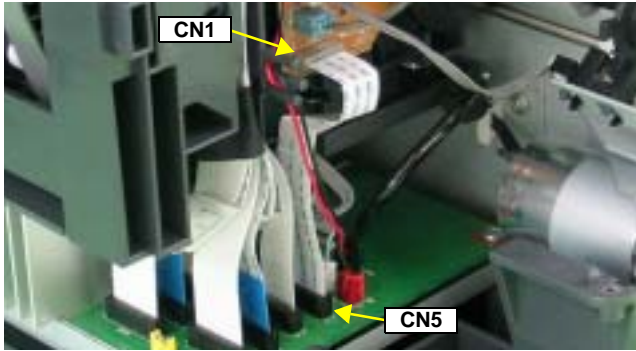
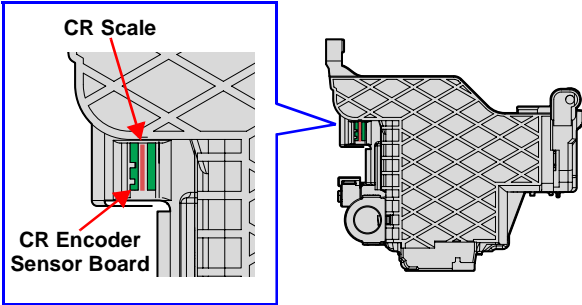
Table 3-12. Troubleshooting of Fatal Error

Occurrence Timing	Phenomenon Detail	Faulty Part/ Part Name	Check Point	Remedy
During printing	After starting to print, ink is not ejected and paper stops midway.	Head FFC	1. Check that the Head FFC is securely connected to the Print Head Connector and Main Board Connectors CN10, CN12, CN13, and CN14.  	1. Connect the Head FFC to the Print Head Connector and Main Board Connectors CN10, CN12, CN13, and CN14.
	2. Check the Head FFC for damages.	2. Replace the Head FFC with a new one.		
	Ink is not ejected from most nozzles.	Print Head	1. Check for occurrence of Head Hot.	1. Replace the Print Head with a new one.

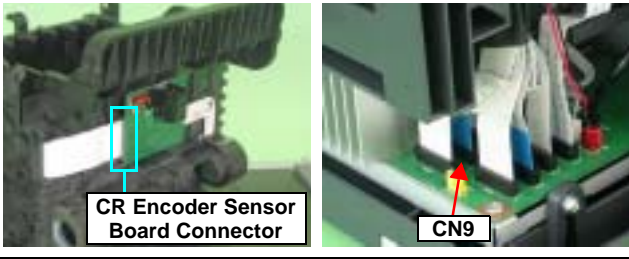
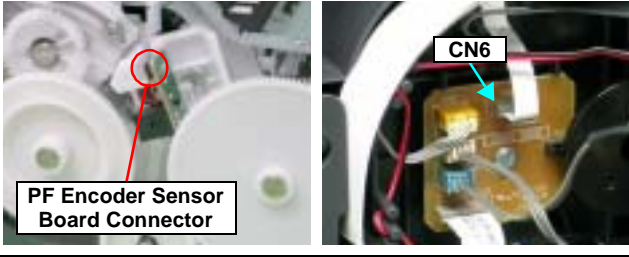
### 3.1.2 Troubleshooting based on Observed Faults

This section provides troubleshooting procedures based on observed faults such as print quality troubles and abnormal noise.

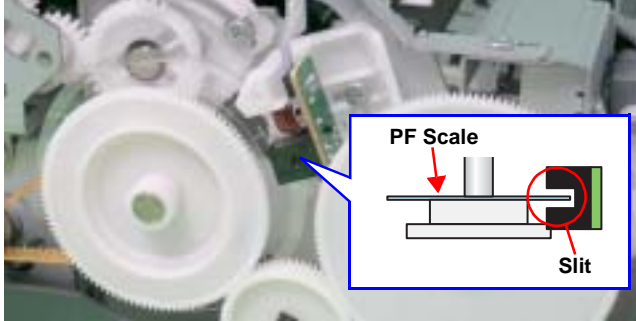
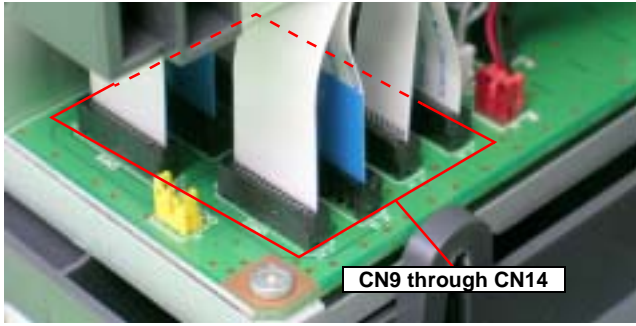
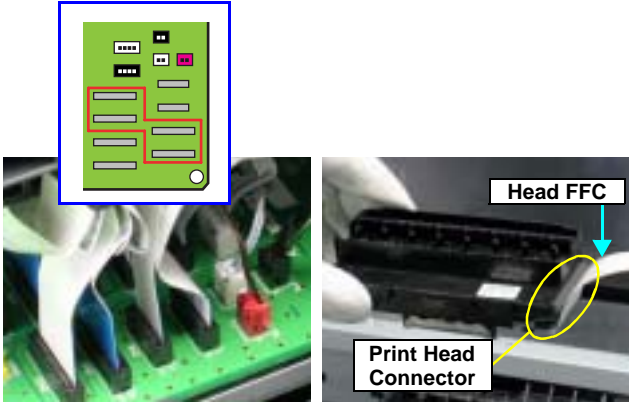
Table 3-13. Print Quality Troubles

Observed Faults	Details of the Fault	Faulty Part/ Part Name	Check Point	Remedy
Dot missing and mixed colors	Inks are not ejected from the Print Head to the Cap.	Ink System Unit(Cap)	1. Check for foreign matter around the Seal Rubber on the Cap Unit. 	1. Remove the foreign matter around the Seal Rubber completely.
			2. Check that the Ink Tube is connected to the Pump Tube. 	2. Connect the Ink Tube to the Pump Tube securely.
			3. Check that the Extension Spring 1.19 IS is correctly installed to the Cap Unit.	3. Replace the Ink System Unit with a new one.



Table 3-13. Print Quality Troubles

Observed Faults	Details of the Fault	Faulty Part/ Part Name	Check Point	Remedy
<p>Dot missing and mixed colors</p>	<p>Although inks are ejected from the Print Head to the Cap, the trouble still occurs after executing a cleaning cycle or replacing the Ink Cartridges.</p>	<p>Print Head</p>	<p>1. Run a Nozzle Check, and check the printed pattern if it has broken lines or missing segments.</p>	<p>1. After running a Head Cleaning, check the Nozzle Check Pattern again.</p>
			<p>2. Check that the Head FFC is securely connected to the Print Head Connector and Main Board Connectors CN11, CN12, CN13, and CN14.</p> 	<p>2. Connect the Head FFC to the Print Head Connector and Main Board Connectors CN11, CN12, CN13, and CN14.</p>
			<p>3. Check if the Head FFC is not damaged.</p>	<p>3. Replace the Head FFC with a new one. If the trouble still occurs after replacing it, replace the Print Head with a new one.</p>
		<p>Ink System Unit Cleaner Blade</p>	<p>1. Check if the Cleaner Blade is covered with paper dust or is bent.</p> 	<p>1. Replace the Ink System Unit with a new one.</p>
		<p>Main Board</p>	<p>1. Check the Main Board for damages.</p>	<p>1. Replace the Main Board with a new one.</p>

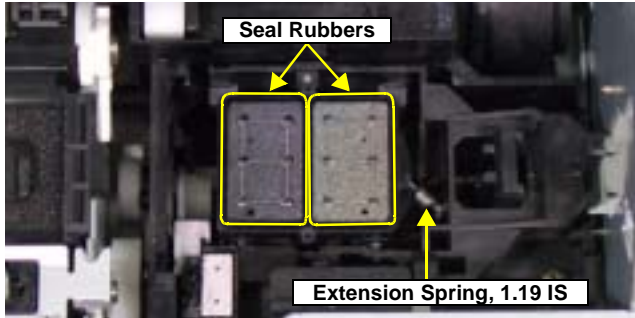
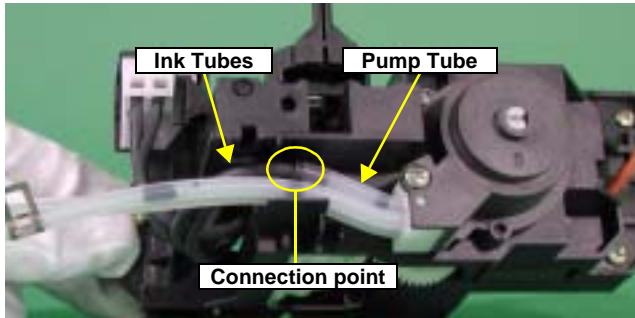

Table 3-13. Print Quality Troubles

Observed Faults	Details of the Fault	Faulty Part/ Part Name	Check Point	Remedy
Horizontal or vertical banding / Getting smeared	Although inks are ejected from the Print Head to the Cap, almost nothing is printed or the print gets smeared with excessive ink after executing a cleaning cycle or replacing the Ink Cartridges.	Head FFC	1. Check that the Head FFC is securely connected to the Print Head Connector and Main Board Connectors CN10, CN12, CN13, and CN14.   The image contains two parts. On the left is a schematic diagram of a green printed circuit board (PCB) with several connectors labeled with 'CN' and 'FFC'. A red box highlights a specific area on the board. On the right is a photograph of the printer's internal components. A yellow circle highlights the 'Print Head Connector' on the main board, and a blue arrow points to the 'Head FFC' cable being inserted into it.	1. Connect the Head FFC to the Print Head Connector and Main Board Connectors CN10, CN12, CN13, and CN14.
		Print Head	1. Check if the print quality recovers after running a cleaning or replacing the Ink Cartridges.	1. Run the cleaning and replace the Ink Cartridges several times. If the trouble still occurs, replace the Print Head with a new one.
		Main Board	2. Check the Main Board for damages.	2. Replace the Main Board with a new one.

Table 3-13. Print Quality Troubles

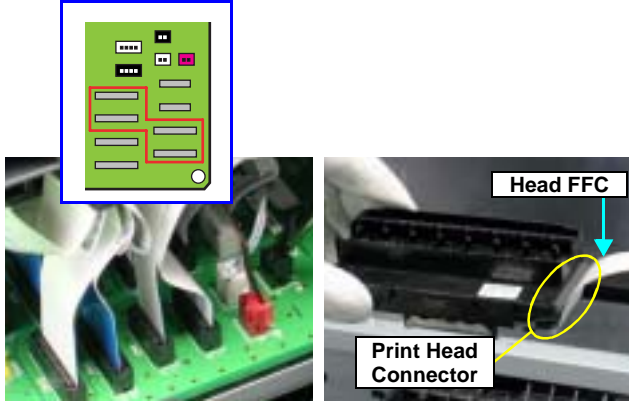
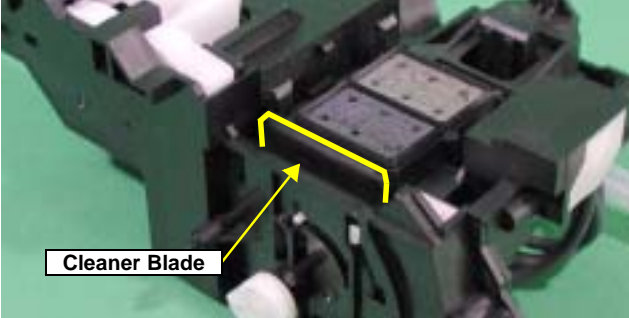
Observed Faults	Details of the Fault	Faulty Part/ Part Name	Check Point	Remedy
Vertical or horizontal banding/ Color shading	<p>The printout has banding vertical to the CR moving direction and is not evenly colored.</p>  <p>* If the trouble still occurs after doing all measures described in the right-hand columns, replace the CR Motor with a new one.</p>	Adjustment	1. For printing in the Bi-D mode, check that the Bi-D Adjustment has been performed properly.	1. Perform Bi-D Adjustment to eliminate displacements between the upper and lower lines. Refer to Chapter 5 " <a href="#">Adjustment</a> ".
		Print Head	1. Run a Nozzle Check, and check the printed pattern if it has broken lines or missing segments.	1. Perform the Head Cleaning, then check the Nozzle Check Pattern. Refer to Chapter 5 " <a href="#">Adjustment</a> ". If the trouble still occurs, replace the Print Head with a new one.
		Carriage Shaft	1. Check the surfaces of the Carriage Shaft for foreign matter.	1. Remove foreign matter from the Carriage Shaft.
			2. Check that the Carriage Shaft is fully lubricated with grease.	2. Wipe the grease applied to the Carriage Shaft with a dry, soft cloth, and then apply G-71 grease. Refer to Chapter 6 " <a href="#">Maintenance</a> ".
Narrow stripes of the same width appear horizontally to the CR moving direction.	 <p>* If the trouble still occurs after doing all measures described in the right-hand columns, replace the PF Motor with a new one.</p>	Printer Driver and the Paper	1. Check if appropriate paper is used in accordance with the Printer Driver settings.	1. Use the appropriate type of paper in accordance with the Printer Driver.
		Print Head	1. Run a Nozzle Check, and check the printed pattern if it has broken lines or missing segments.	1. Perform the Head Cleaning, then check the Nozzle Check Pattern. Refer to Chapter 5 " <a href="#">Adjustment</a> ". If the trouble still occurs, replace the Print Head with a new one.
		PF Roller Shaft	1. Check the surface of the PF Roller Shaft for foreign matter.	1. Clean the PF Roller surface carefully.
			2. Check the PF Roller Shaft for damages.	2. Replace the PF Roller with a new one.

Table 3-13. Print Quality Troubles

Observed Faults	Details of the Fault	Faulty Part/ Part Name	Check Point	Remedy
Vertical or horizontal banding/ Color shading	When printing at 360 dpi, horizontal banding and color unevenness appears at a constant frequency.	Adjustment	1. Check that PF Adjustment has executed properly.	1. Perform PF Adjustment properly. Refer to Chapter 5 "Adjustment".
			2. Check for Dot missing.	2. Replace the Ink System Unit with a new one.
	Star Wheel Rollers traces appear in the CR moving direction.	Paper EJ Frame Assy.	1. Check that the Star Wheel Units have not come off or the Star Wheel Rollers turns normally.	1. Install the Star Wheel Units to the Paper EJ Frame Assy correctly.
				
Printout is faint or blurry.		Printer Driver and the Paper	1. Check that adequate paper is used according to the setting of the Printer Driver.	1. Use the appropriate type of paper in accordance with the Printer Driver.
		Print Head	1. Using the Adjustment Program, check that the correct Head ID has been written to the EEPROM.	1. Using the Adjustment Program, enter the 31- digit code of the Head ID to the EEPROM. Refer to Chapter 5 "Adjustment".
	The bottom of the printout is not evenly colored.	Adjustment	1. Check if the Positioning Adjustment of PF Roller Shaft Retainer has been performed properly.	1. Make adjustments according to the specified adjustment priority. Refer to Chapter 5 "Adjustment".
Paper EJ Roller traces appear on the printout.	Traces of the Paper EJ Roller appear on the printed paper or CD-R.	Printer Driver and the Paper	1. Check if appropriate paper is used in accordance with the Printer Driver settings.	1. Use the appropriate type of paper in accordance with the Printer Driver.
		Front and Rear Paper EJ Roller Assys.	1. Check if the Paper EJ Roller is clean or not.	1. Clean the Paper EJ Roller using the Roller Cleaning Mode.

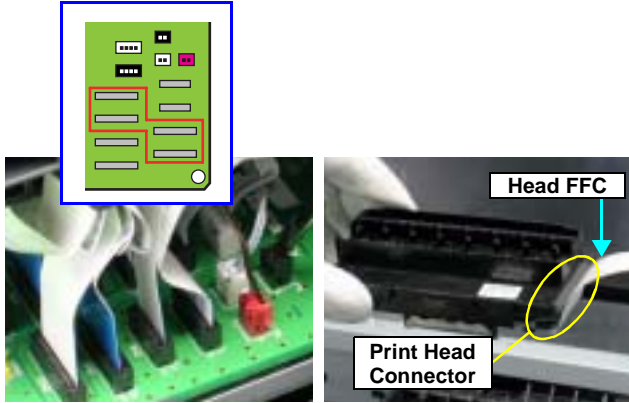
Table 3-13. Print Quality Troubles

Observed Faults	Details of the Fault	Faulty Part/ Part Name	Check Point	Remedy
<p>The printout is stained with ink.</p>	<p>The non-printed side or the bottom of the printout is dirty with ink.</p>	<p>Front Paper Guide Pad</p>	<p>1. Check that heaps of ink are not formed on the Front Paper Guide Pad and that the Front Paper Guide Pad is installed securely and evenly in the setting position.</p> 	<p>1. If heaps of ink are formed, replace the Front Paper Guide. If it has been confirmed that the Ink pads have risen, reinstall the Front Paper Guide Pad correctly.</p>
	<p>When the paper size in the sent print data is larger than the size of the fed paper, data are printed on the Front Paper Guide, extending off the paper.</p>	<p>PW sensor</p>	<p>1. Check that the PW Sensor FFC is connected. 2. Check that the PW Sensor is not faulty.</p>	<p>1. Connect the PW Sensor FFC. 2. Replace the PW Sensor with a new one.</p>
<p>Ink smudges appear on the blank area of the printout.</p>		<p>Paper EJ Frame Assy.</p>	<p>1. Check the Star Wheel Rollers for ink stain.</p>	<p>1. Clean the Star Wheel Rollers with a soft cloth.</p>
		<p>Front Paper Guide</p>	<p>1. Check the Front Paper Guide for ink stain.</p>	<p>1. Clean the Front Paper Guide with a soft cloth.</p>
		<p>Front Paper Guide Pad</p>	<p>1. Check if ink heaps are formed on the Front Paper Guide Pad.</p>	<p>1. Replace the Front Paper Guide with a new one.</p>

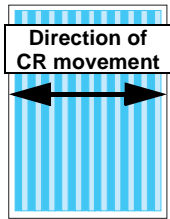
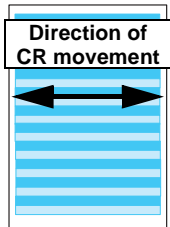
Table 3-13. Print Quality Troubles

Observed Faults	Details of the Fault	Faulty Part/ Part Name	Check Point	Remedy
<p>The printout is stained with ink.</p>	<p>Ink smudges appear on the blank area of the printout.</p>	<p>Front and Rear Paper EJ Roller Assys</p>	<p>1. Check the Front and Rear Paper EJ Roller Assys for ink stain.</p> 	<p>1. Clean the Front and Rear Paper EJ Roller Assys with a soft cloth.</p>
		<p>Driven Roller Shaft</p>	<p>1. Check the Driven Roller Shaft for ink stain.</p>	<p>1. Clean the Driven Roller Shaft with a soft cloth.</p>
		<p>Ink System Unit</p>	<p>1. Check that wiping operation was performed properly.</p> 	<p>1. Install the Cleaner blade correctly or replace it with a new one.</p>

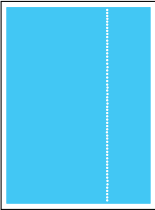
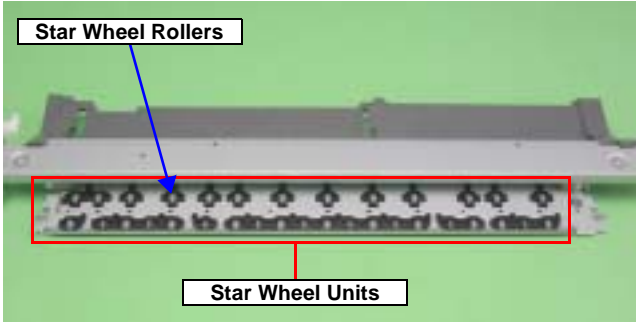
Table 3-13. Print Quality Troubles

Observed Faults	Details of the Fault	Faulty Part/ Part Name	Check Point	Remedy
The printout is stained with ink.	Ink smudges appear on the blank area of the printout.	PF Roller Shaft	1. Check the PF Roller Shaft for ink stain. 	1. Clean the PF Roller Shaft with a soft cloth.
The printout is grainy.	Images are printed grainy in all print modes. Or the image looks rough.	Adjustment Main Board Print Head	1. Check that PG, Bi-D and Head Angular Adjustments have been made properly. 2. Print the adjustment check patterns and check if they are grainy.	1. Make the adjustments according to the specified adjustment priority. Refer to Chapter 5 " <a href="#">Adjustment</a> ". 2. If the images look still grainy after adjustment, replace the Main Board with a new one.
	When printed at 5760 dpi, the printed images are poor or grainy.	Adjustment Main Board Print Head	1. After making sure that PG, Bi-D and Head Angular Adjustments have been made correctly, check whether PW Sensor has been adjusted properly. 2. Print the adjustment check patterns and check if the printed images are still poor or grainy.	1. Make the adjustment according to the specified adjustment priority. Refer to Chapter 5 " <a href="#">Adjustment</a> ". 2. If the image quality does not improve after the adjustment, replace the Print Head and Main Board in this order, and check the image graininess.
Regarding hue of images	The whole image is reddish.	Adjustment Print Head	1. Check if the PG has been adjusted properly.	1. Make the adjustment according to the specified adjustment priority. Refer to Chapter 5 " <a href="#">Adjustment</a> ".
			2. Check that Bi-D and Head Angular Adjustments have been made properly.	2. Make the adjustments according to the specified adjustment priority. Refer to Chapter 5 " <a href="#">Adjustment</a> ".
			3. Print the adjustment check patterns and check the image color.	3. If the image color does not change after adjustment, replace the Print Head with a new one.

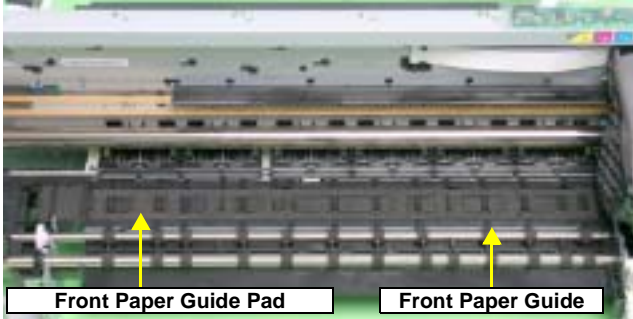
Table 3-13. Print Quality Troubles

Observed Faults	Details of the Fault	Faulty Part/ Part Name	Check Point	Remedy
Borderless Printing	Cannot make a borderless printing (The printer prints with margins despite the borderless setting).	PW sensor	1. Check if the paper dust or scrap of the paper is attached to the Front Paper Guide.	1. Remove the paper dust or scrap of the paper.
			2. Check that the PW Sensor is operating normally. Print the adjustment check patterns with the Adjustment Program, and check that the clip function is executed normally. (The clip function is executed normally if an about 5mm margin is provided on the left of the first gray band pattern in the patterns.)	2. If it is judged that the clip function is not executed normally, replace the PW sensor with a new one. Refer to Chapter 5 " <a href="#">Adjustment</a> ".

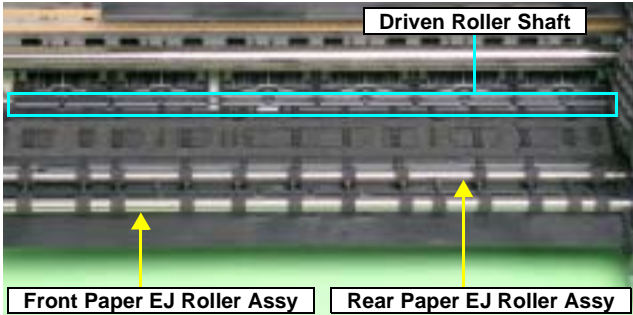
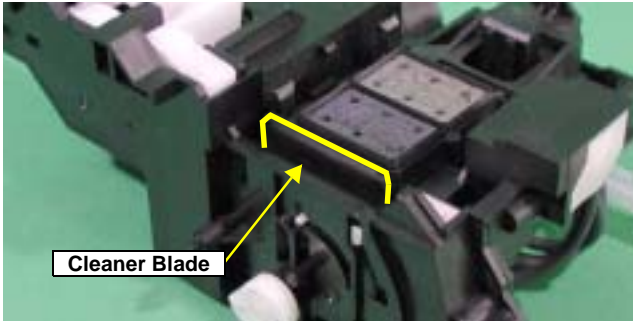
Table 3-14. Abnormal Noise

Occurrence Timing	Details of the Fault	Faulty Part/ Part Name	Check Point	Remedy
–	Printing operation is performed normally but abnormal noise is produced at power-on or during operations.	Adjustment	1. Check that PF Belt Tension Adjustment has been executed properly.	1. Make the adjustment according to the specified adjustment priority. Refer to Chapter 5 " <a href="#">Adjustment</a> ".
		Carriage Shaft	1. Check that the Carriage Shaft is fully lubricated with grease.	1. Wipe the grease applied to the Carriage Shaft with a dry, soft cloth, and then apply grease (G-71). Refer to Chapter 6 " <a href="#">Maintenance</a> ".

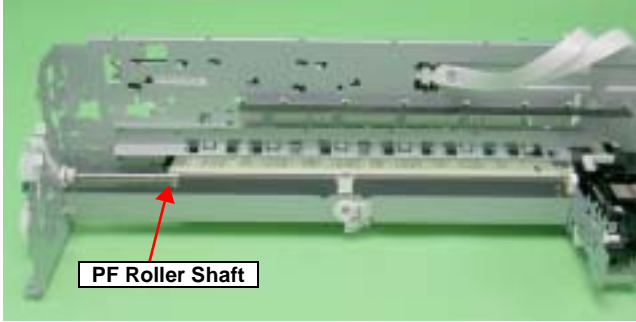
CHAPTER

4

# DISASSEMBLY AND ASSEMBLY



## 4.1 Overview

This chapter describes procedures for disassembling and assembling this product. Unless otherwise specified, the disassembled units or main components can be reassembled by reversing the disassembling procedure.

- WARNINGS must be followed to avoid personal injury or death.
- CAUTIONS must be followed to avoid damaging the printer or test equipment.
- ADJUSTMENT REQUIRED indicates that specific mandatory adjustments must be carried out to complete the repair.
- CHECK POINTS emphasize a particularly important process or procedure.
- REASSEMBLY notes provide helpful tips on reassembly procedures, especially when correct reassembly differs from simple reverse-assembly.

When you need to disassemble any units or parts that are not described in this chapter, refer to the exploded diagrams in the Appendix.

Before starting your work, always read the precautions described in the next section.

### 4.1.1 Precautions

Before starting the disassembling/reassembling work of this product, always read the following "WARNING" and "CAUTION" carefully.



- **Before starting the disassembling/reassembling work of this product, always disconnect the power cable. When the power supply cable must be connected for voltage measurement or like, be extremely careful not to get an electric shock and follow the procedures in this manual to do your work.**
- **Wear protective goggles to protect your eyes from ink. If ink gets in your eyes, wash your eyes with clean water and see a doctor.**
- **To prevent injury from sharp metal edges, always wear gloves for disassembly and reassembly.**
- **If ink has adhered to your skin, wash it with soap and water. If it has caused skin irritation, see a doctor.**
- **To protect the microprocessors and circuitry, use static discharge equipment, such as anti-static wrist straps when accessing the internal components.**

## CAUTION



- When transporting a printer that uses HAV Ink Cartridges, remove all the cartridges beforehand. Especially for air transportation, make sure to remove cartridges because ink will flow into the Cap Unit via the Print Head due to the reduction of the atmospheric pressure, which may cause ink leakage.
- Use only the recommended tools for disassembly, reassembly and adjustment. Refer to Table 4-1 Tool List on page 74.
- Tighten screws to the specified torques.
- Use the specified lubricants and adhesives. Refer to Chapter 6 "Maintenance".
- Make the necessary adjustments under the instructions given for disassembling. Refer to Chapter 5 "Adjustment".

## 4.1.2 Tools

The following table indicates the tools recommended for use for disassembly, reassembly and adjustment.

Table 4-1. List of Tools

Tool Name	Code
Phillips Screw Driver, No.1	1080530
Phillips Screw Driver, No.2	1080532
Flat-blade Screwdriver	1080527
Tweezers	1080561
Needle nose pliers	1080564
Acetate Tape	1003963
PF Tension Measuring Tool	1231678
Penlight	—

The above tools are all available in the market



### 4.1.3 Screws

The following table lists the screws used in this product. When disassembling and reassembling the printer, refer to the following table and use the specified screws in the specified positions.

**Table 4-2. List of Screw Types**

Image	Description	Image	Description
	1) C.B.P. 3x10		2) C.B.S. 3x6
	3) C.B.S. (P2) 3x10		4) C.B.P. 3x8
	5) C.B.S. 3x8		6) C.B.S. (P4) 3x8
	7) C.B.P. 2.6x8		8) C.B.S. (P4) 3x6
	9) C.B.P. 3x6		10) C.B.S. 3x4

**Table 4-2. List of Screw Types**

Image	Description	Image	Description
	11) C.C. 3x4		12) C.P.B. (P1) 1.7x5
	13) C.B.P. 2.6x5		

## 4.1.4 Work Completion Checklist

Whenever the printer is serviced, use the checklist shown below to confirm all work is completed properly and the printer is ready to be returned to the user.

**Table 4-3. Work Completion Check**

Classification	Item	Check Point	Check Field
Main Unit	Self-test	Is the operation normal?	<input type="checkbox"/> Checked / <input type="checkbox"/> Not necessary
	On-line Test	Is the printing attempt successful?	<input type="checkbox"/> Checked / <input type="checkbox"/> Not necessary
	Print Head	Is ink discharged normally from all the nozzles?	<input type="checkbox"/> Checked / <input type="checkbox"/> Not necessary
	Carriage Mechanism	Does it move smoothly?	<input type="checkbox"/> Checked / <input type="checkbox"/> Not necessary
		Are there any abnormal noises during its operation?	<input type="checkbox"/> Checked / <input type="checkbox"/> Not necessary
		Are there any dirt or foreign objects on the CR Shaft?	<input type="checkbox"/> Checked / <input type="checkbox"/> Not necessary
		Is the CR Motor at the correct temperature? (Not too hot to touch?)	<input type="checkbox"/> Checked / <input type="checkbox"/> Not necessary
	Paper Feeding Mechanism	Is paper advanced smoothly?	<input type="checkbox"/> Checked / <input type="checkbox"/> Not necessary
		No paper jamming?	<input type="checkbox"/> Checked / <input type="checkbox"/> Not necessary
		No paper skew?	<input type="checkbox"/> Checked / <input type="checkbox"/> Not necessary
		No multiple-sheet feeding?	<input type="checkbox"/> Checked / <input type="checkbox"/> Not necessary
		Is the PF Motor at correct temperature? (Not too hot to touch?)	<input type="checkbox"/> Checked / <input type="checkbox"/> Not necessary
		No abnormal noises?	<input type="checkbox"/> Checked / <input type="checkbox"/> Not necessary
Is the paper path free of obstructions?		<input type="checkbox"/> Checked / <input type="checkbox"/> Not necessary	
Adjustment	Specified Adjustment	Are all the adjustments correctly completed?	<input type="checkbox"/> Checked / <input type="checkbox"/> Not necessary
Lubrication	Specified Lubrication	Has lubrication been applied at the specified points?	<input type="checkbox"/> Checked / <input type="checkbox"/> Not necessary
		Is the amount of lubrication correct?	<input type="checkbox"/> Checked / <input type="checkbox"/> Not necessary
Function	ROM Version	Version: _____	<input type="checkbox"/> Checked / <input type="checkbox"/> Not necessary
Packing	Ink Cartridge	Have the ink cartridges been removed?	<input type="checkbox"/> Checked / <input type="checkbox"/> Not necessary
	Protective Materials	Have all relevant protective materials been attached to the printer?	<input type="checkbox"/> Checked / <input type="checkbox"/> Not necessary
Others	CD-R Tray	Is the operation normal?	<input type="checkbox"/> Checked / <input type="checkbox"/> Not necessary
	Cutter Unit	Is the operation normal?	<input type="checkbox"/> Checked / <input type="checkbox"/> Not necessary
	Accessories	Have all the accessories sent by the user been included in the package?	<input type="checkbox"/> Checked / <input type="checkbox"/> Not necessary

## 4.2 Disassembly

The flowchart below lists the step-by-step disassembly procedures. When disassembling each unit, refer to the page number shown in the figure.

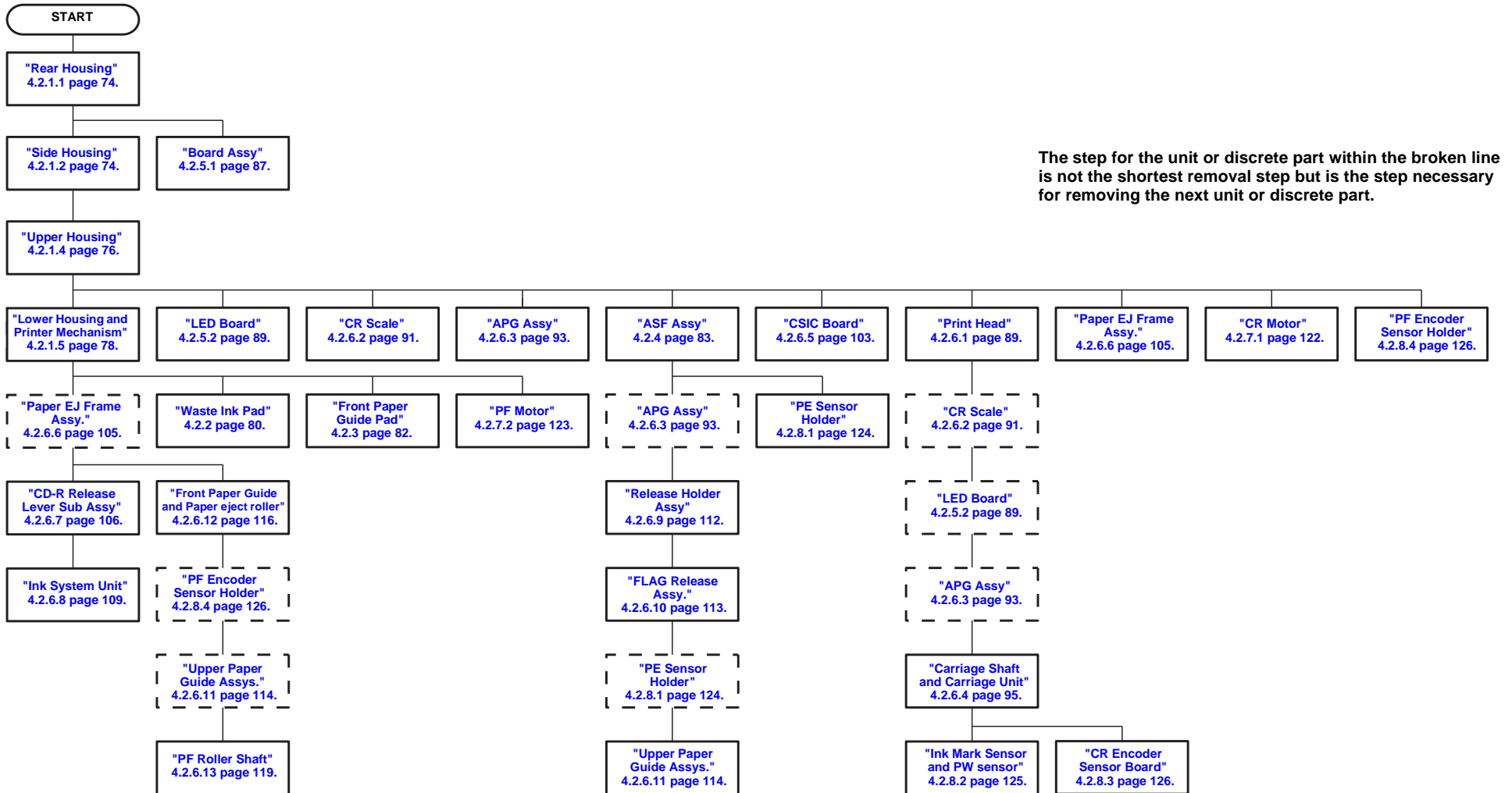

The step for the unit or discrete part within the broken line is not the shortest removal step but is the step necessary for removing the next unit or discrete part.

Figure 4-1. Disassembly Flowchart

## 4.2.1 Removing the Housings

### 4.2.1.1 Rear Housing

1. Remove the four C.B.P. M3 x 10 screws and the C.B.S. M3 x 6 screw that secure the Rear Housing, and remove it from the printer.

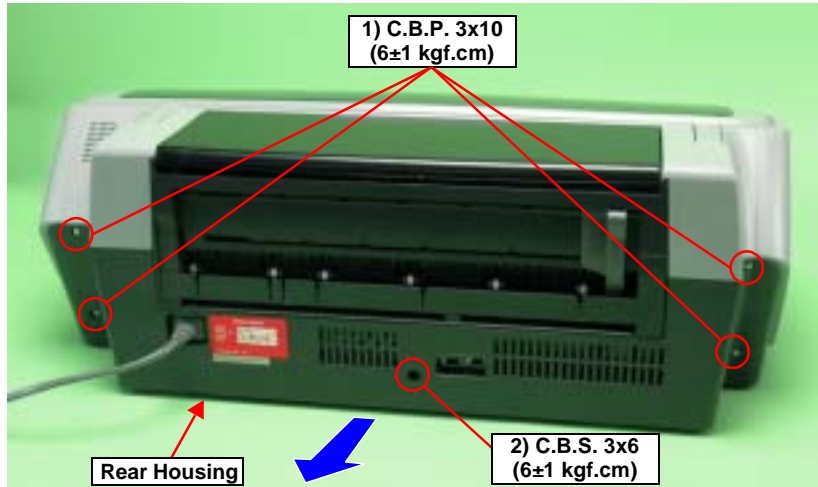

Figure 4-2. Removing the Rear Housing

### 4.2.1.2 Side Housing

1. Remove the Rear Housing. [See Section 4.2.1.1 on page 74.](#)
2. Insert a flat-blade screwdriver into the notch on the side of the Lower Housing, and lift it in the direction of the arrow to remove the Left Side Housing releasing the two tabs. Remove the Right Side Housing in the same way.



Figure 4-3. Removing the Side Housings



Match the positioning holes of the Upper Housing with the guide pins of the Side Housing.

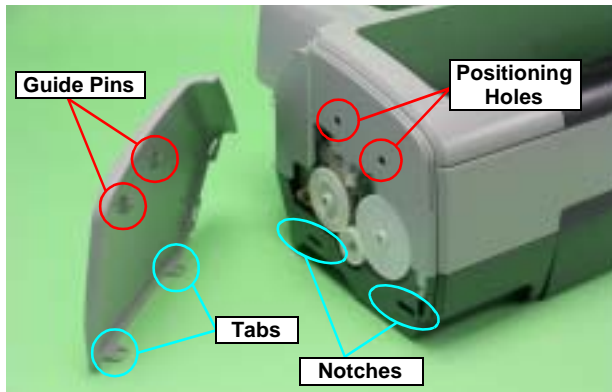

Figure 4-4. Reinstalling the Side Housing

### 4.2.1.3 Locking/Releasing the Carriage and Opening/Closing the CD-R Unit

Locking/releasing the Carriage and opening/closing the CD-R Unit are mutually related. The CD-R Unit cannot be opened when the Carriage Lock is released.

1. Remove the Right Side Housing. See Section 4.2.1.2 on page 74.
2. Insert the flat-blade screwdriver into the hole on the right side of the frame, and rotate the white shaft of the Ink System Unit.

Table 4-4. Relationship between Carriage Lock and CD-R Unit

Direction of Rotation	Carriage	CD-R Unit
Clockwise (CW)	Locked	Can be opened/closed.
Counterclockwise (CCW)	Released	Locked

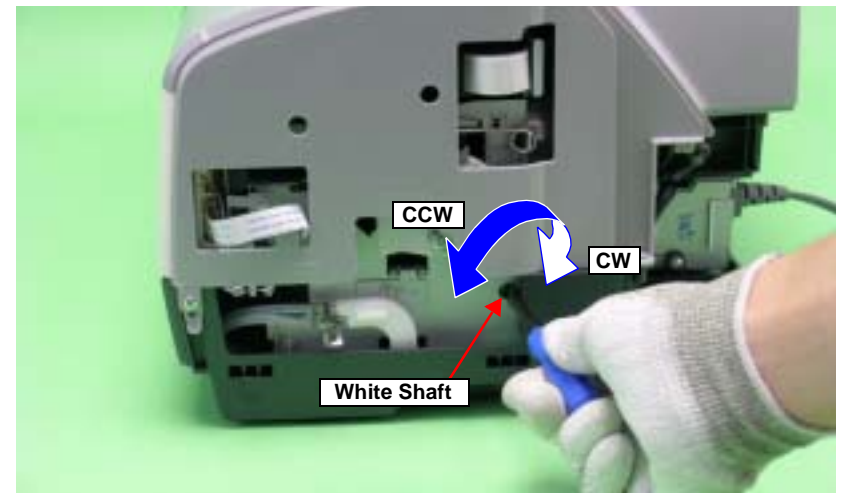

Figure 4-5. Locking/Releasing the Carriage and Opening/Closing the CD-R Unit



When moving the Carriage Unit with the CD-R Unit opened, turn the PG CAM (Right) beforehand so that PG++ points downwards to release the PG in order to prevent interference between the Paper EJ Frame and Carriage Unit.

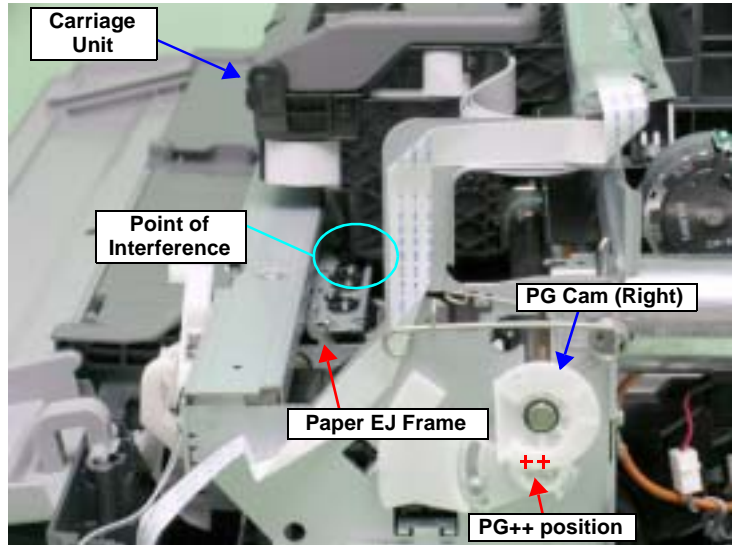

Figure 4-6. Interference between the Frame and Carriage Unit

### 4.2.1.4 Upper Housing

1. Remove the Side Housing. See Section 4.2.1.2 on page 74.
2. Open the Printer Cover and Paper Support.
3. Open the CD-R Unit. See Section 4.2.1.3 on page 75.
4. Remove the six C.B.P. M3 x 10 screws and three C.B.S. M3 x 6 screws that secure the Upper Housing.

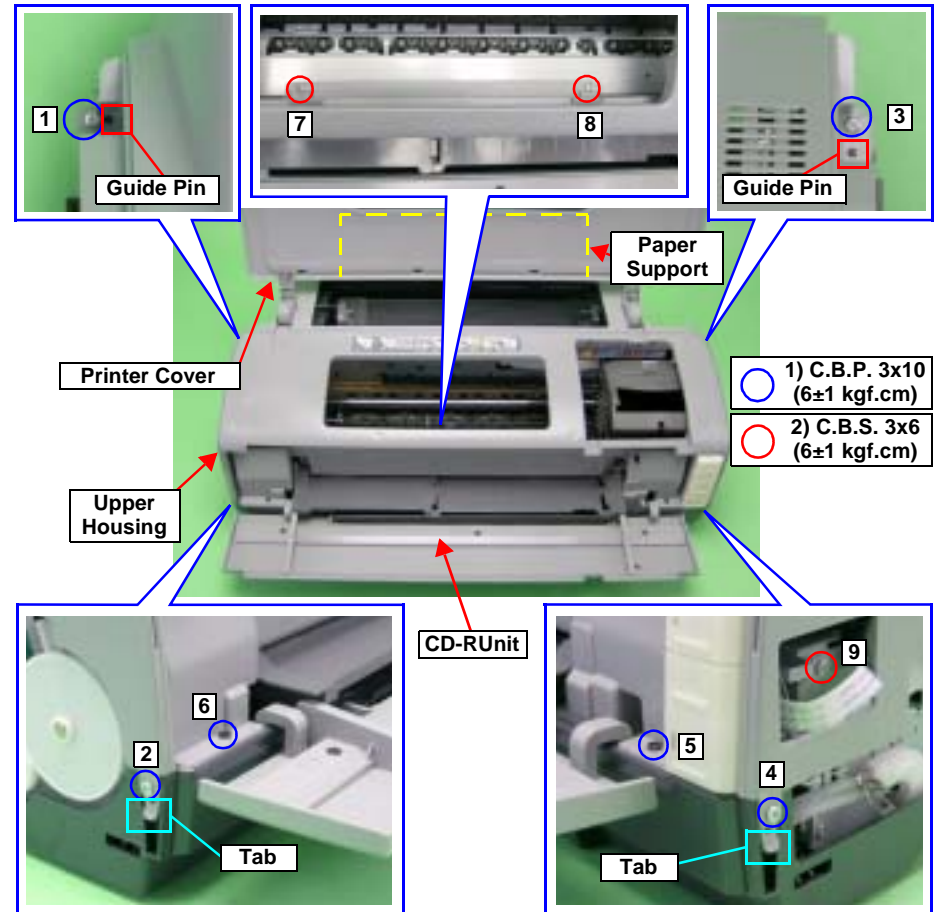

Figure 4-7. Screws that Secure the Upper Housing



- Disconnect the Panel FFC and CD-R Sensor Cable from connectors CN1 and CN2 on the Switch Board, and release the CD-R Sensor Cable from the tabs of the Upper Housing.

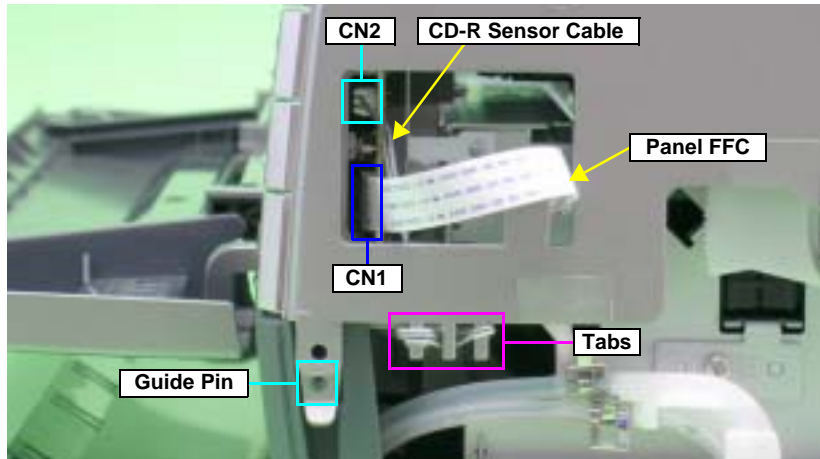

Figure 4-8. Disconnecting the CD-R Sensor Cable and Panel FFC

- Remove the Guide Pins from the two Tabs shown in [Figure 4-7.](#), and remove the Upper Housing upwards.



- Align the Guide Pins with the positioning holes on the Upper Housing. [See Figure 4-7.](#)
- When inserting the CD-R Sensor Cable into the Switch Board, press the Connector CN2 to make sure that it is firmly installed on the Switch Board.
- Referring to [Figure 4-7.](#), correctly route the Panel FFC and CD-R Sensor Cable.
- Tighten the screws in the order shown in [Figure 4-7.](#)

## PRINTER COVER

- Remove the two C.B.P. M3 x 10 screws that secure the Left Printer Cover Holder, and draw it out in the direction of the arrows. Remove the Right Printer Cover Holder in the same way.

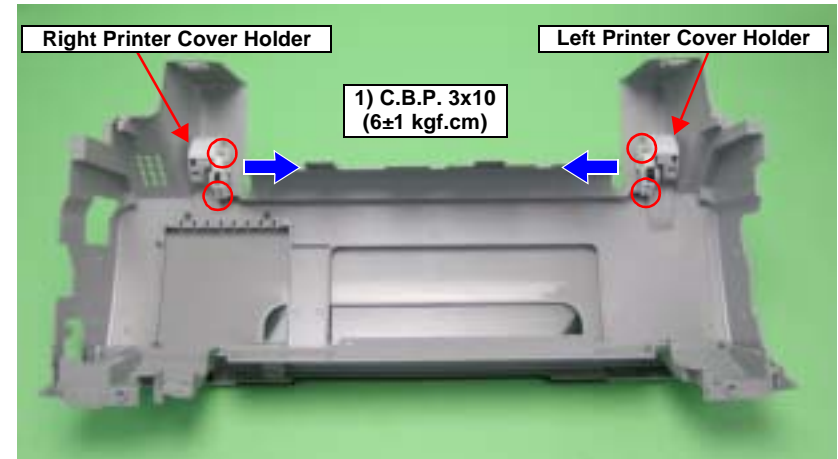

Figure 4-9. Disconnecting the Printer Cover Holder

- Lift the Upper Housing in the direction of the arrows, pull the Guide Pin on the Upper Housing away from the notch on the printer cover, and remove the Printer Cover.

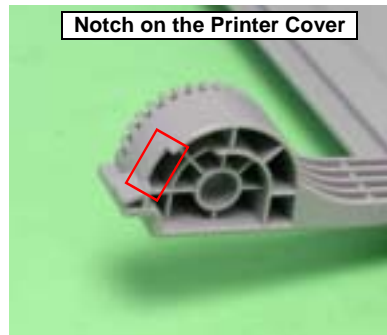
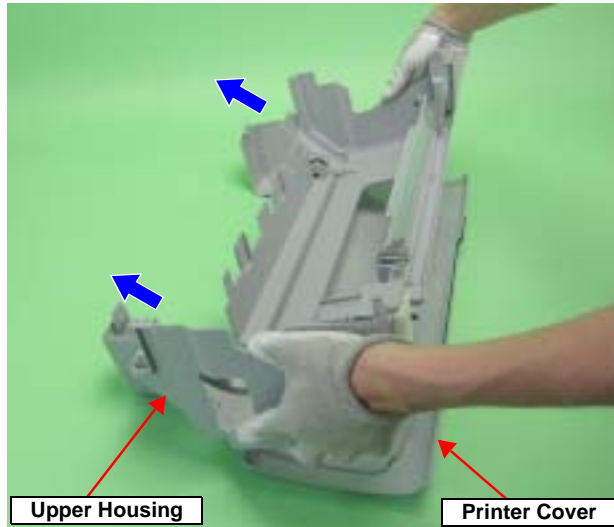

Figure 4-10. Removing the Printer Cover

#### 4.2.1.5 Lower Housing and Printer Mechanism

- Remove the Upper Housing. See Section 4.2.1.4 on page 76.
- Grip both ends of the two Ink Tube Fasteners with your fingers, slide them in the direction of the arrows, and draw out the Waste Ink Tubes from the two Ink Tubes.
- Remove the four C.B.P. M3 x 10 screws and two C.B.S. (P2) M3 x 10 screws that secure the Printer Mechanism.



If you hold the Printer Mechanism at locations other than the handling positions when performing the following procedure, the frame might become deformed. Be sure to hold the Printer Mechanism by the positions.

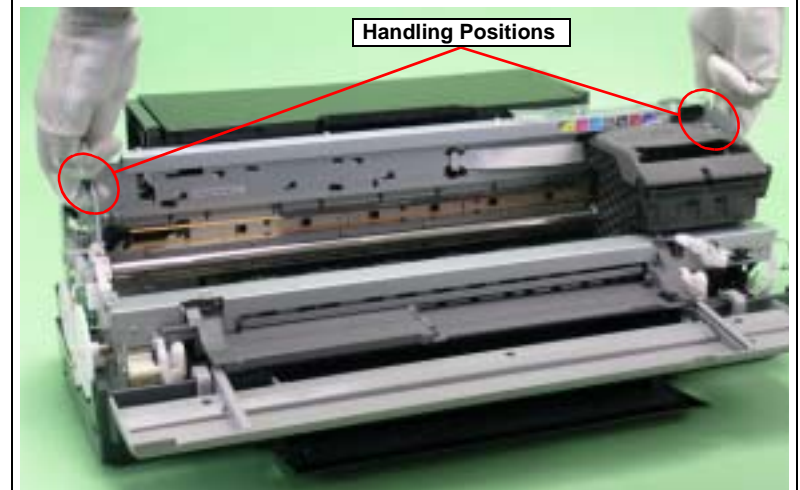

Figure 4-11. Handling the Printer Mechanism

- Hold the Printer Mechanism by its handling positions with both hands, and remove it from the Lower Housing.

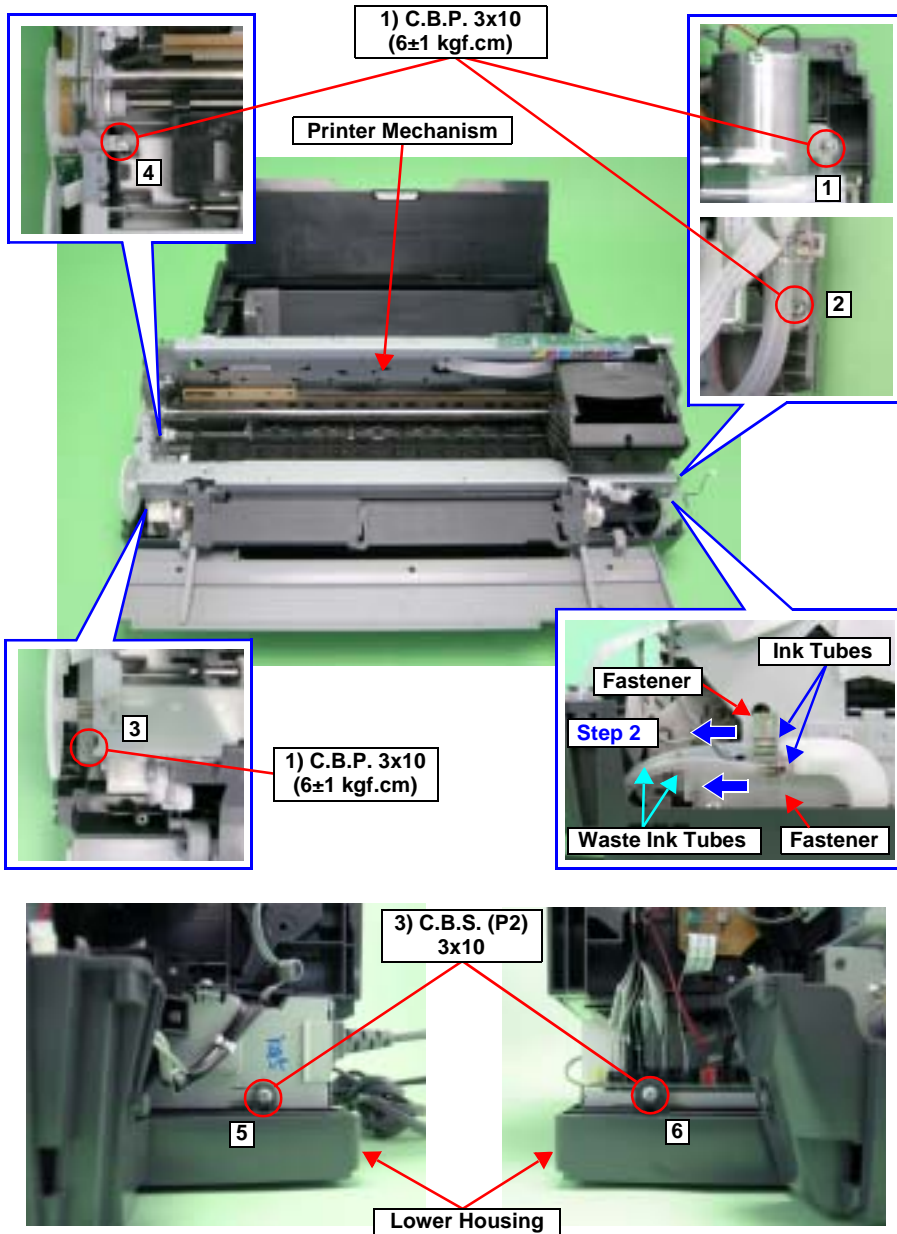

Figure 4-12. Screws that Secure the Printer Mechanism



■ Insert the Waste Ink Tube with the red line into the lower Ink Tube.

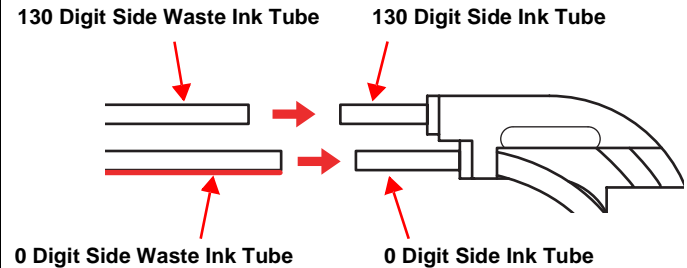

Figure 4-13. Installing the Ink Tubes

- Make sure that the Waste Ink Tubes are not nipped by the Printer Mechanism.
- Tighten the screws in the order shown in [Figure 4-12](#).



After replacing the Printer Mechanism, be sure to make the following adjustments.

1. Platen Gap (PG) Adjustment
  2. Ink Mark Sensor Adjustment
  3. Head Angular Adjustment
  4. Auto Bi-D Adjustment
  5. Ink Mark Sensor Adjustment
  6. First dot position
  7. PW Sensor Adjustment
  8. PF Deterioration Compensation Counter Reset
  9. PF Adjustment
  10. PF Adjustment (Bottom Margin)
  11. CR Motor Drive Dispersion Measurement Sequence
- Refer to Chapter 5 "Adjustment" for details of the adjustments.

### 4.2.2 Waste Ink Pad

1. Remove the Lower Housing. See Section 4.2.1.5 on page 78.
2. Remove the C.B.P. M3 x 8 screw that secures the Waste Ink Tube.
3. Remove the 15 Waste Ink Pads from the Lower Housing.

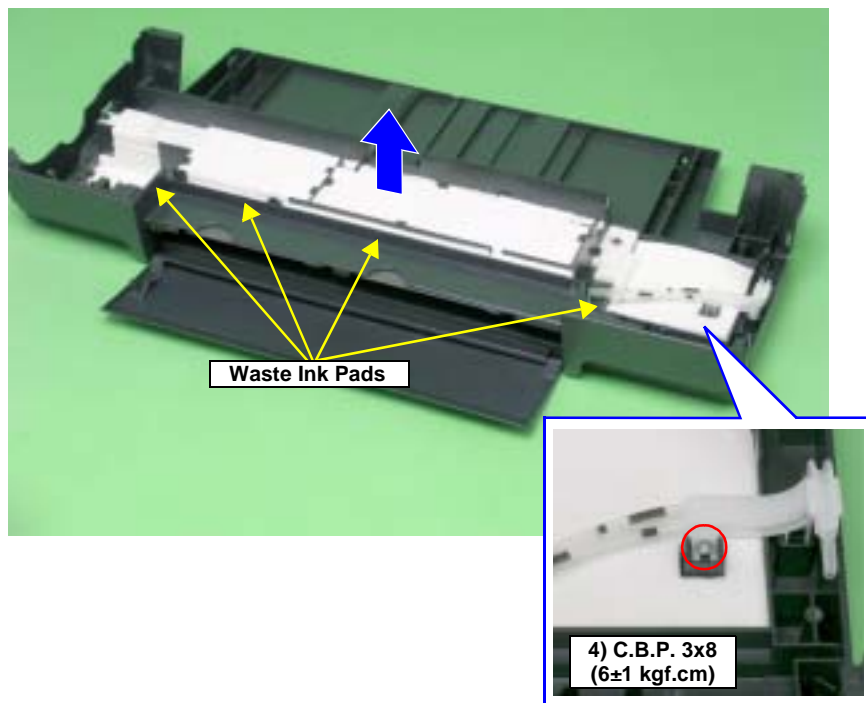

Figure 4-14. Removing the Waste Ink Pads



- Referring to Figure 4-15., correctly install the Waste Ink Pads.

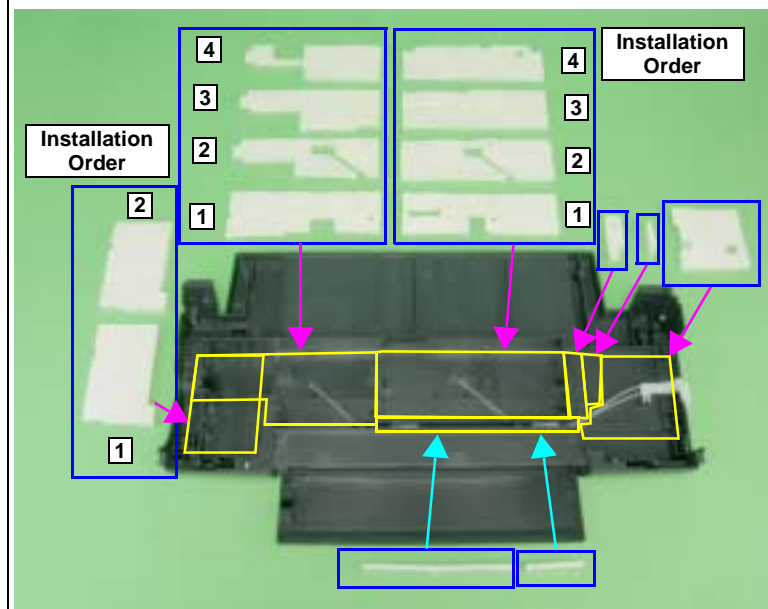

Figure 4-15. Reinstalling the Waste Ink Pads

**REASSEMBLY**

- Check the positions and the routing of the Upper and Lower Waste Ink Tubes.

0 digit side : Lower side

130 digit side : Upper side

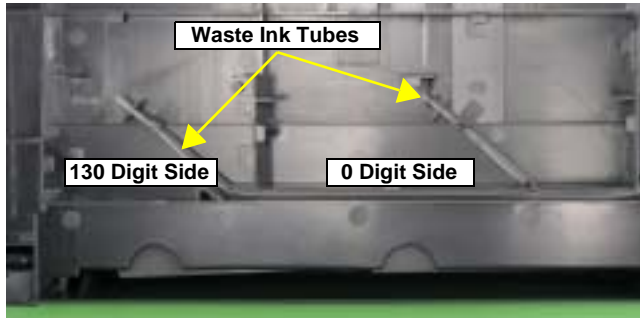

Figure 4-16. Positions of Waste Ink Tubes

**ADJUSTMENT  
REQUIRED**

After replacing or removing the Waste Ink Pads, always make the following adjustment.

- Waste Ink Protection Counter Clear

Refer to Chapter 5 "Adjustment" for details of the adjustment.



### 4.2.3 Front Paper Guide Pad

1. Remove the Printer Mechanism. See Section 4.2.1.5 on page 78.
2. Remove the Front Paper Guide Pads and Front Paper Guide Pad Protection from the Front Paper Guide with tweezers.

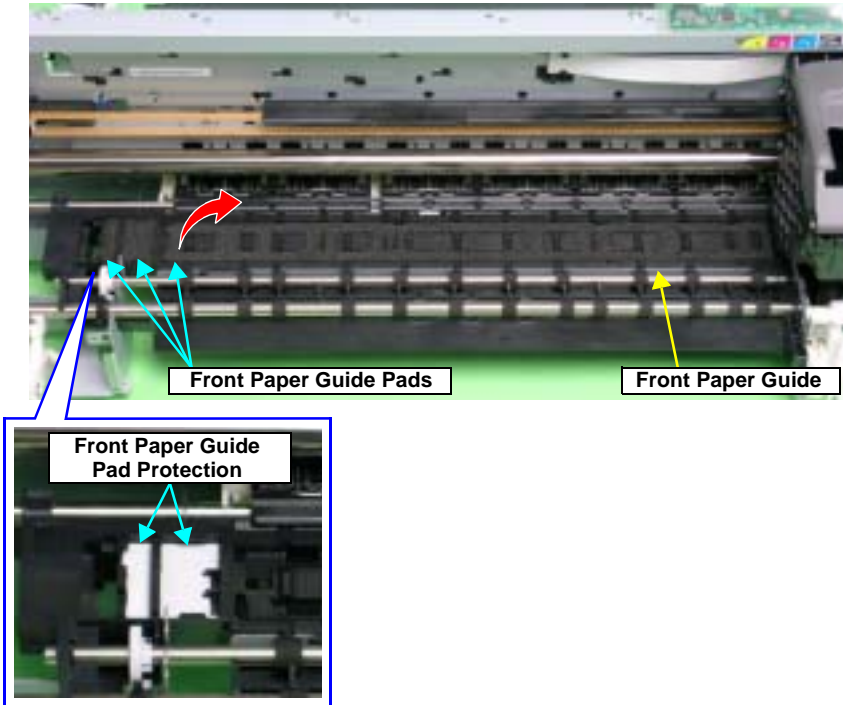

Figure 4-17. Removing the Front Paper Guide Pads and the Front Paper Guide Pad Protection



Take care to prevent the grease contained on the Front Paper Guide Pads and Front Paper Guide Pad Protection from sticking to other parts.



After installing the Front Paper Guide Pads and Front Paper Guide Pad Protection, lift the Printer Mechanism, and check the following points.

1. Make sure that the Tabs on the Pads are not cut midway.
2. Make sure that all Tabs are in place on the Front Paper Guide, and that they are facing down (towards the Waste Ink Pads) without any folds.
3. Make sure that the Tab foldbacks are protruding completely from the Front Paper Guide.

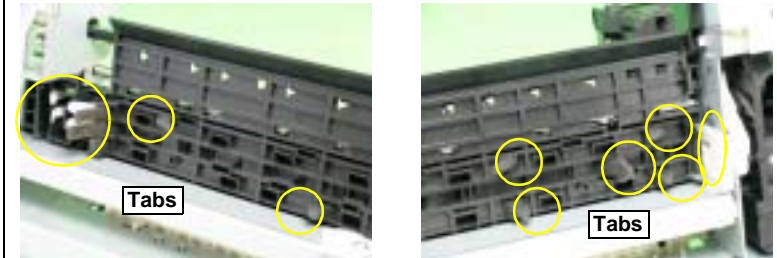

Figure 4-18. Reinstalling the Front Paper Guide Pad (1)

4. Make sure that the Pad is placed under a tab of the Front Paper Guide.

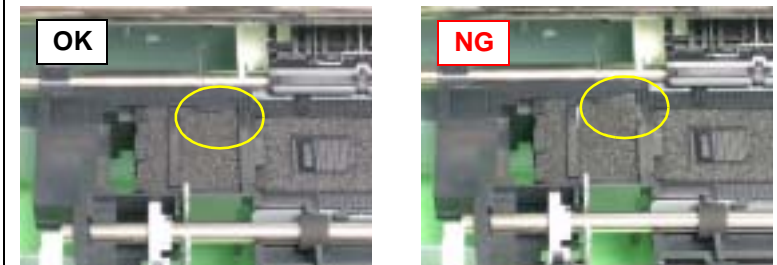

Figure 4-19. Reinstalling the Front Paper Guide Pad (2)

5. Make sure that all the Tabs on the Pads are fitted into the securing section under the Front Paper Guide.

### 4.2.4 ASF Assy

1. Remove the Upper Housing. See Section 4.2.1.4 on page 76.
2. Remove the C.B.S. M3 x 8 screw that secures the Earth Cables on the right rear side of the printer, and remove the Earth Cables.
3. Disconnect the ASF Motor Connector from the Relay Connector.
4. Disconnect the Relay Connector Cable from the ASF Assy.

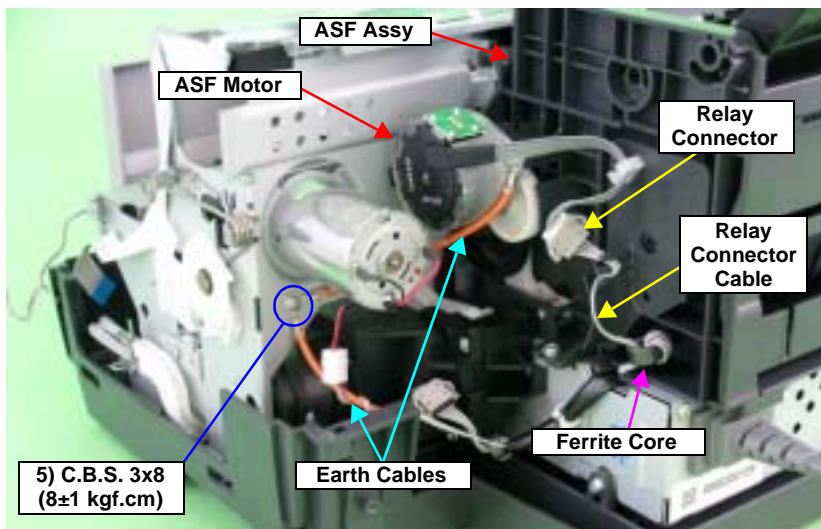

Figure 4-20. Releasing the Cables (1)



- Secure the two Earth Cables together with the screw.
- Referring to Figure 4-20., correctly route the Relay Connector Cable.

5. Disconnect all Cables and the FFC from the connectors on the Relay Board.
  - CN1 : Relay FFC
  - CN2 : PE Sensor Cable
  - CN4 : APG Sensor Cable (downside)
  - CN5 : APG Sensor Cable (the upper side)
  - CN6 : PF Encoder Sensor FFC
6. Disconnect the FFC bundled by the Acetate Tape from the CN8 to CN14 on the Main Board, and release it from the groove on the ASF Assy.
7. Disconnect the APG Motor Cable and PE Sensor Cable from the ASF Assy.
8. Peel off the PF Encoder FFC secured by two pieces of double-sided adhesive tape from the ASF Assy.

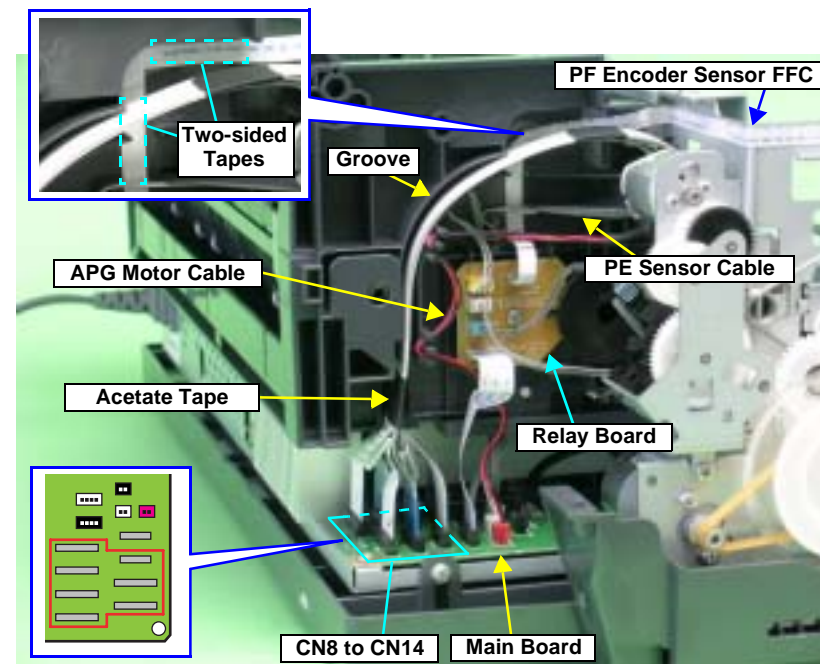

Figure 4-21. Releasing the Cables (2)



Referring to [Figure 4-21.](#), correctly route each of the Cables and FFC.

9. Remove the two C.B.S. M3 x 6 screws that secure the two Guide Roller LDs.
10. Gently pull the LD Roller Shaft to the rear of the printer, and remove the Guide Roller LDs.

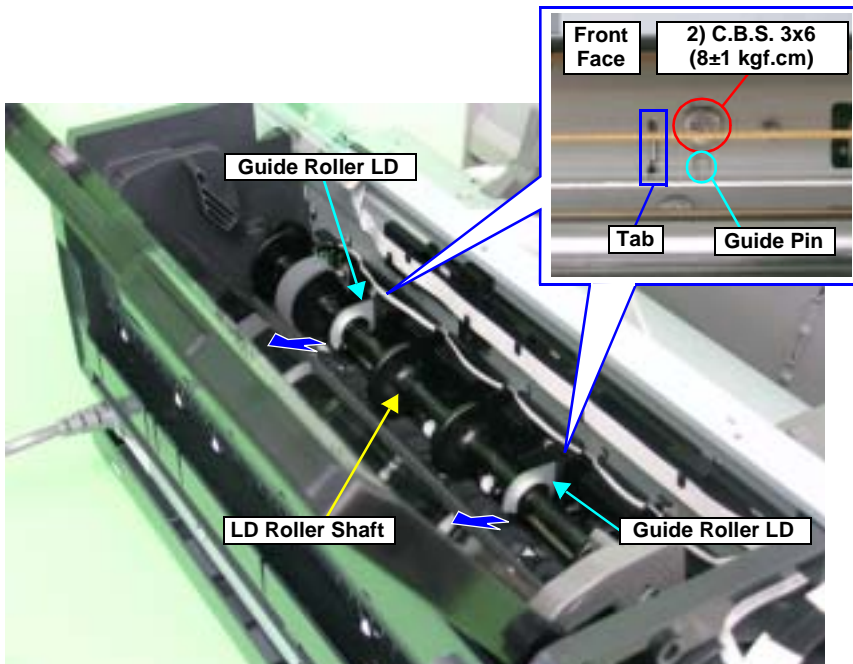

Figure 4-22. Removing the Guide Roller LD



Align the Guide Pins and Tabs on the Guide Roller LDs with the positioning holes on the Main Frame. Refer to [Figure 4-22.](#)

11. Remove the three C.B.S. (P4) M3 x 8 screws that secure the ASF Assy, and remove the ASF Assy from the Printer Mechanism.

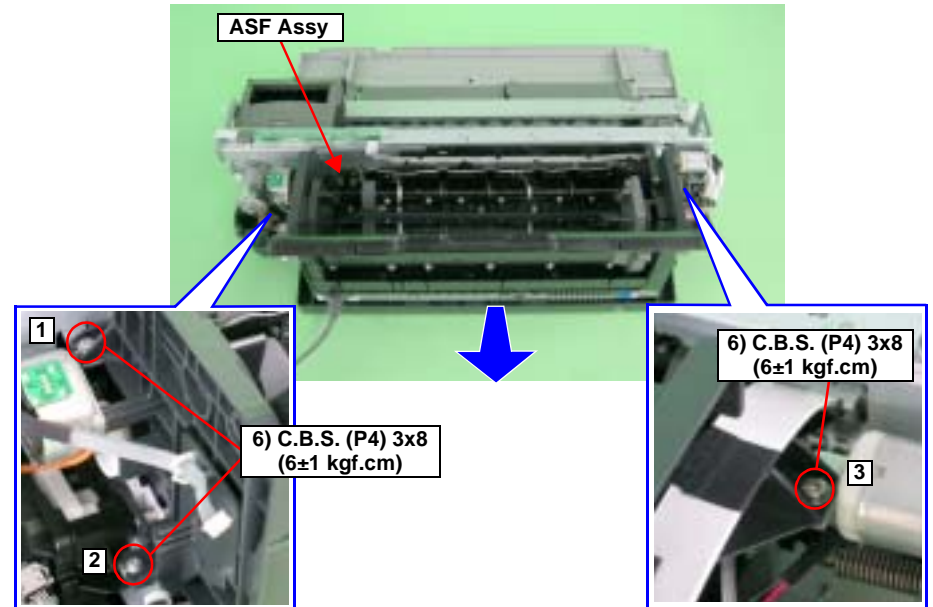

Figure 4-23. Removing the ASF Assy



## REASSEMBLY



- Align the Guide Pin and four Tabs on the ASF Assy with the positioning holes on the Main Frame so that there is no gap between the ASF Assy and the Main Frame.

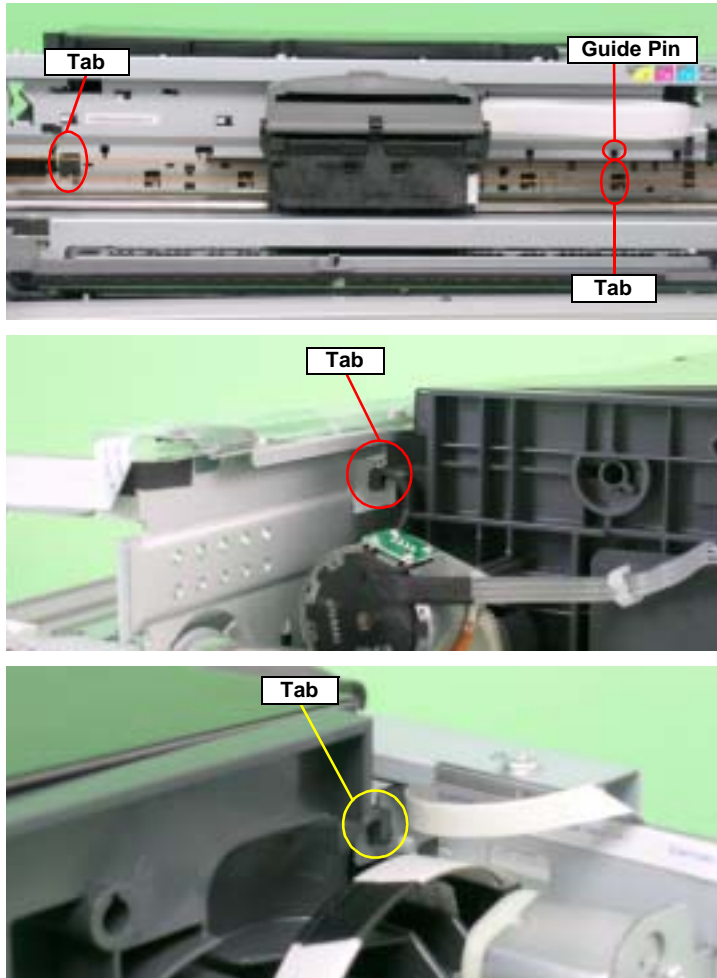

Figure 4-24. Reinstalling the ASF Assy.

- Tighten the screws in the order shown in [Figure 4-23](#).

## REASSEMBLY



- Adjusting the Position of the ASF Guide Roller LDs  
When installing the Guide Roller LDs, the position of the Guide Roller LDs must be adjusted so that the positions of the LD Roller Shaft and Retard Roller are optimized in order to maintain the paper feed accuracy.

- After installing the ASF Assy, loosen the two C.B.S. M3 x 6 screws that secure the Guide Roller LD. Refer to [Figure 4-22](#).
- Turn Combination Gear 29.11 on the right side of the ASF Assy CCW to raise the Hopper to the upper limit position (until the Hopper Pad contacts the LD Roller).

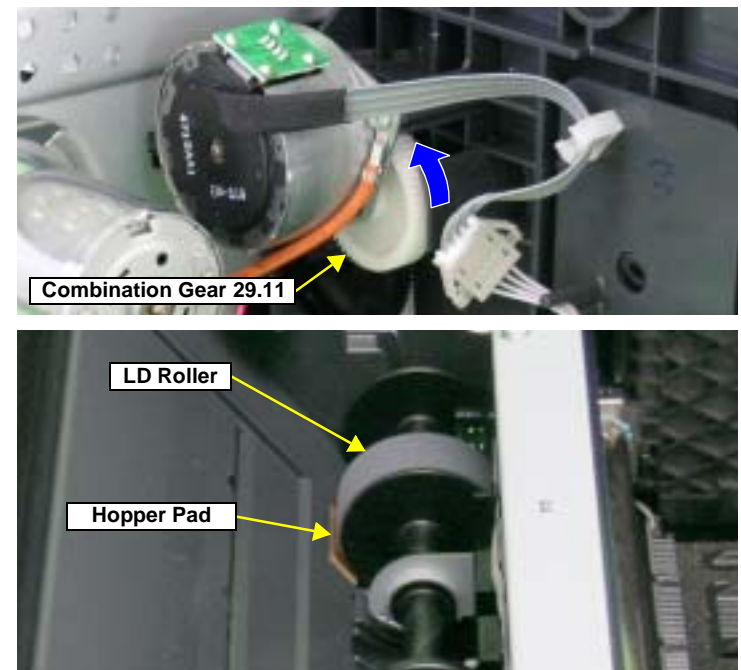
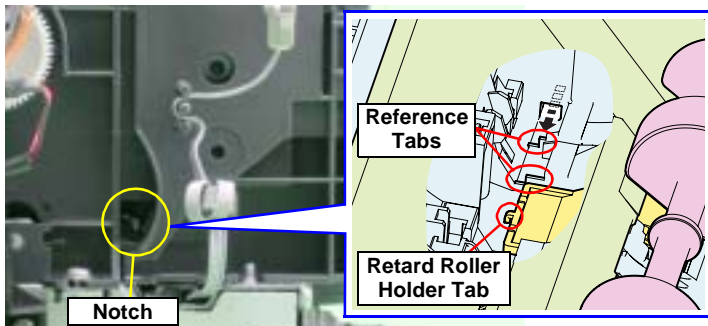
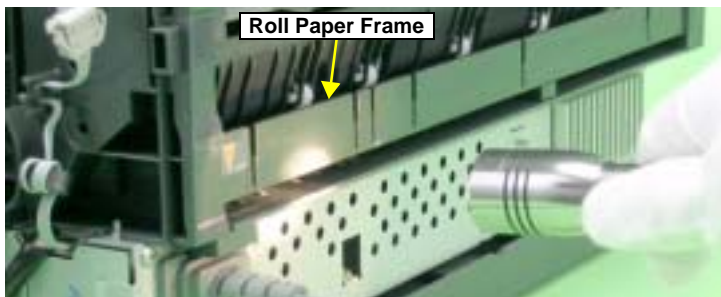

Figure 4-25. Raising the Hopper



3. Look the printer's inside through a gap between the Roll Paper Frame and the ASF Assy with a penlight. You can see the Tab on the Retard Roller Holder at the back of the two Reference Tabs on the ASF Assy. After making sure that the two Reference Tabs are aligned when viewed edge-on, adjust the position of the Retard Roller Holder Tab by pressing the Guide Roller LD (0 digit side) so that it is placed within the range as shown in the simplified diagram below.



■ The Range of the Retard Roller Holder Tab

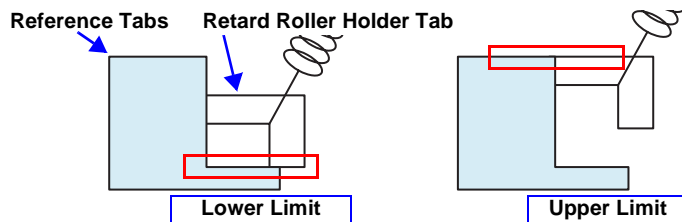

Figure 4-26. Aligning the Position of the Guide Roller LD (0 Digit Side)



4. Align the Guide Pin and Tab on the 0 Digit Side Guide Roller LD with the positioning holes on the Main Frame, and tighten the Guide Roller LD (0 Digit Side) with the screws. See Figure 4-27.
5. Check the position of the Retard Roller Holder Tab again through the gap. If it is not inside the range, remove the screws on the Guide Roller LD (0 Digit Side), and repeat steps 2 to 4 to set the Tab within the range.
6. Check the clearance in both ends of the positioning hole that the Guide Roller LD Tab is inserted. And align Guide Roller LD (130 Digit Side) to the same height, and tighten with the screws.

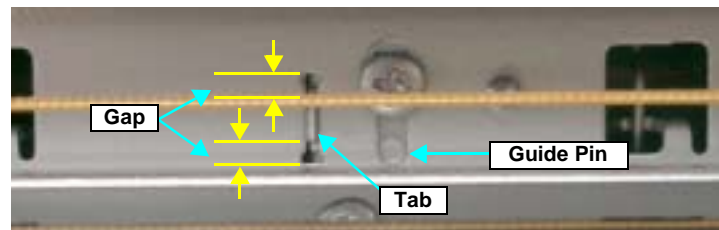

Figure 4-27. Checking the Position of Tab on the Guide Roller LD

Table 4-5. Trouble Caused by Setting Mistakes

Tab Position	Trouble
Above upper limit	<ul style="list-style-type: none"> <li>• Paper feed mistakes caused by non-feed</li> <li>• Skewing of business cards</li> </ul>
Below lower limit	<ul style="list-style-type: none"> <li>• Multiple-sheet feeding</li> </ul>



The following adjustment must be performed when the ASF Assy is replaced or removed:

■ First dot position

Refer to Chapter 5 "Adjustment" for details of the adjustments.

## 4.2.5 Removing the Boards

### 4.2.5.1 Board Assy

1. Remove the Rear Housing. See Section 4.2.1.1 on page 74.
2. Remove the four C.B.S. M3 x 6 screws and two C.B.S. (P2) M3 x 10 screws that secure the Board Assy.

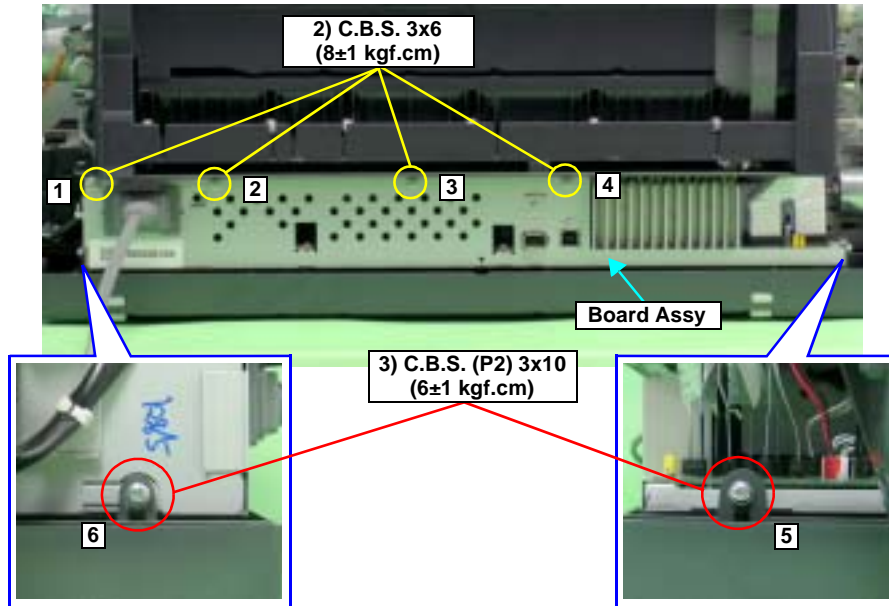

Figure 4-28. Screws that Secure the Board Assy



Tighten the screws in the order shown in Figure 4-28.



When performing the following procedure, prevent the FFC and Connector Cables from being scratched.

3. Disconnect all the FFCs and Connector Cables connected to the Board Assy in order from the front, and draw out the Board Assy from the Printer taking care to avoid interference between the Manual Paper Guide and the Ground Plates on the Board Assy.

- CN5 : Relay FFC
- CN8 : LED FFC
- CN9 : Sensor FFC
- CN10 : Sensor FFC
- CN11 : Head FFC
- CN12 : Head FFC
- CN13 : Head FFC
- CN14 : Head FFC
- CN16 : PF Motor Connector Cable
- CN17 : Relay Connector Cable (for Pump Motor)
- CN18 : APG Motor Connector Cable
- CN19 : Relay Connector Cable (for CR Motor)

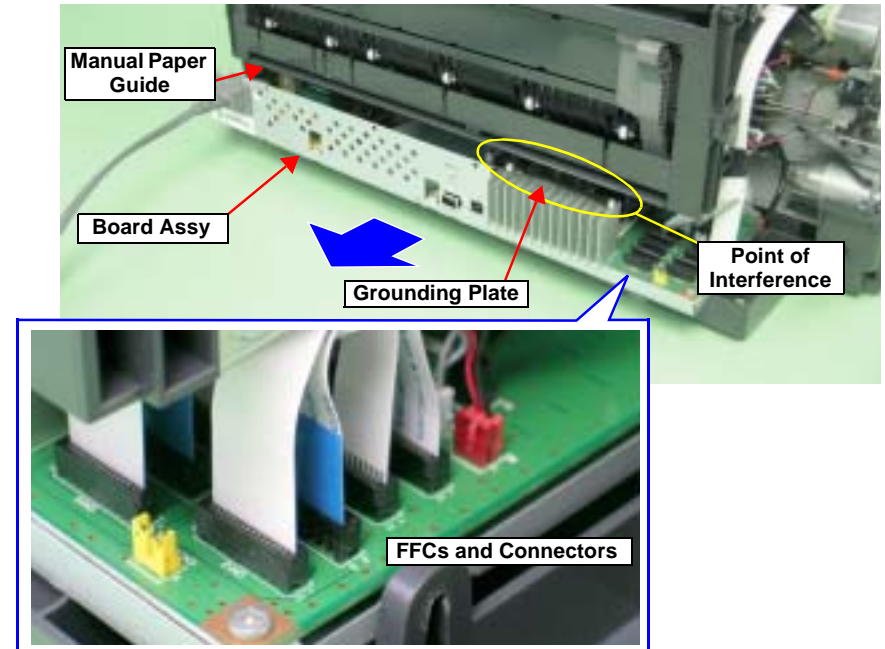

Figure 4-29. Removing the Board Assy

**REASSEMBLY**

- Make sure that the FFCs are not crossing each others, and connect each of the FFCs and Connector Cables to the Main Board while paying attention to the edge of the Shield Plate.
- Take care not to put the Board Assy onto the three Ground Plates.

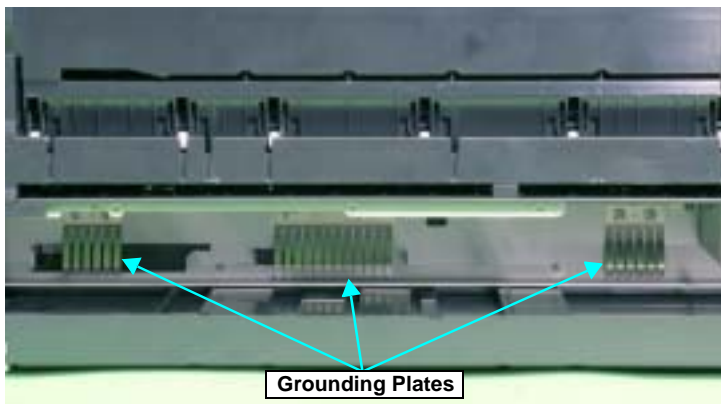

Figure 4-30. Reinstalling the Board Assy

**ADJUSTMENT  
REQUIRED**

The following adjustment must be performed after replacing the Main Board.

- When possible to read data from the old board
  - 1.Main Board Data Read/Write
  - 2.Colorimetric Calibration
- When impossible to read data from the old board
  - 1.Market & Initial Settings
  - 2.USB ID Input
  - 3.IEEE-1394 ID Input
  - 4.Head ID Input
  - 5.Ink Mark Sensor Adjustment
  - 6.Head Angular Adjustment
  - 7.Auto Bi-D Adjustment
  - 8.Ink Mark Sensor Adjustment
  - 9.First dot position
  - 10.PW Sensor Adjustment
  - 11.Reset PF Deterioration counter (write the maximum value)
  - 12.PF Adjustment
  - 13.PF Adjustment (Bottom Margin)
  - 14.Colorimetric Calibration
  - 15.CR Motor Drive Dispersion

Refer to Chapter 5 "Adjustment" for details of the adjustments.

**ADJUSTMENT  
REQUIRED**

The following adjustment must be performed after replacing the Power Supply Board.

- CR Motor Drive Dispersion
- Refer to Chapter 5 "Adjustment" for details of the adjustments.



### 4.2.5.2 LED Board

1. Remove the Upper Housing. See Section 4.2.1.4 on page 76.
2. Peel off a piece of acetate tape from the LED Sheet.
3. Release the three Tabs from the LED sheet, and open the LED sheet.
4. Peel off a piece of acetate tape from the Panel FFC, and remove the Panel FFC from the LED Board.
5. Remove the LED FFC from the LED Board.
6. Remove the C.B.S. (P4) M3 x 8 screw that secures the LED Board, and remove the LED Board.

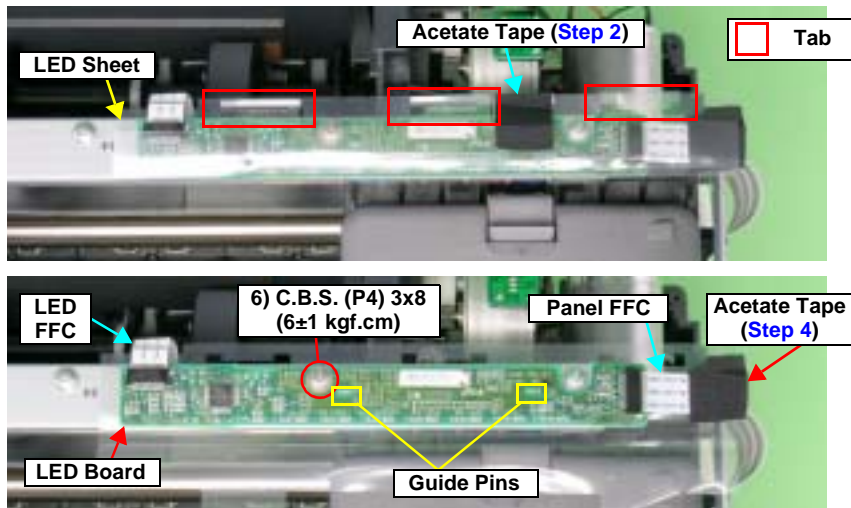

Figure 4-31. Removing the LED Board



Align the two Tabs on the Upper Housing with the positioning holes on the LED Board. See Figure 4-31.

### 4.2.6 Disassembling the Printer Mechanism

#### 4.2.6.1 Print Head

1. Remove the Upper Housing. See Section 4.2.1.4 on page 76.
2. Release the Carriage lock, and move the Carriage Unit to the center. See Section 4.2.1.3 on page 75.
3. Open the Ink Cartridge Cover.



When performing the following procedure, take care to prevent the Tab receptacle on the FFC Guide from being damaged.

4. Release the FFC Guide from the three Tabs to remove the FFC Guide from the Carriage Unit.

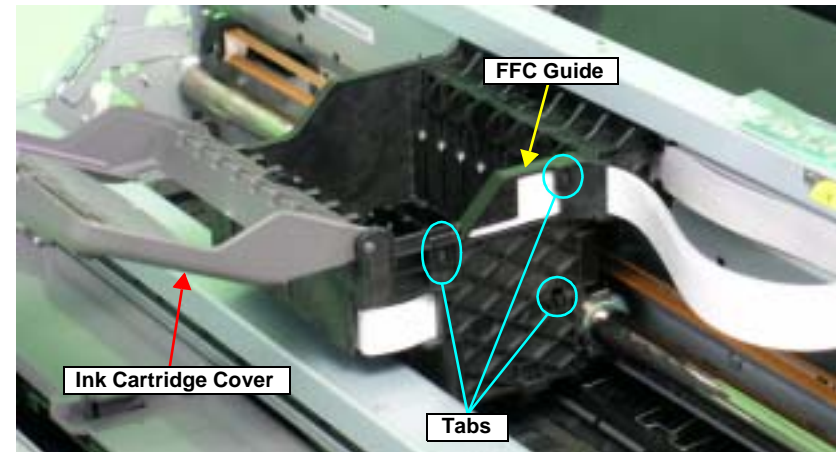

Figure 4-32. Removing the FFC Guide

- Remove the three C.B.P. M2.6 x 8 screws that secure the Print Head using No.1 Phillips Screw Driver, and vertically lift the Print Head to remove.

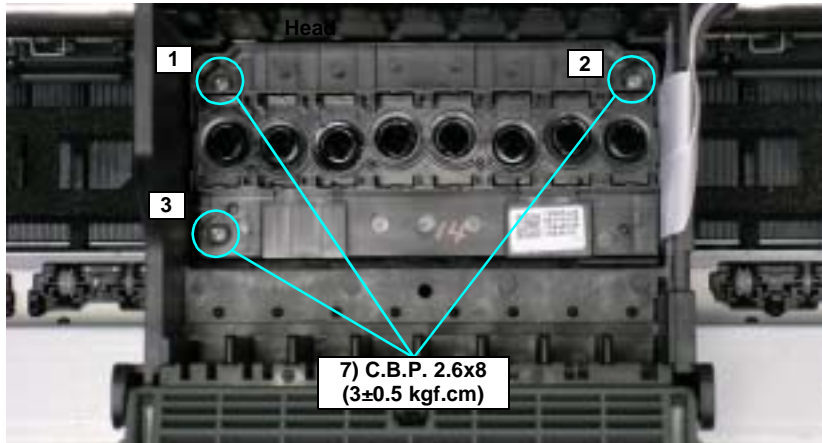

Figure 4-33. Removing the Print Head

- Remove the two Head FFCs from the Print Head.

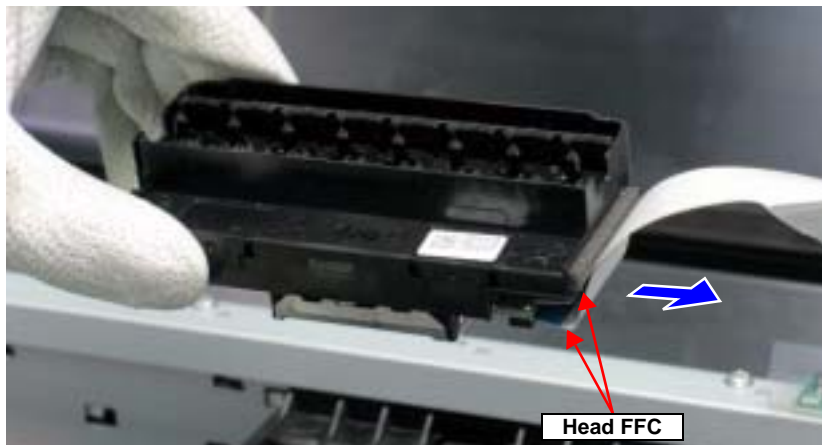

Figure 4-34. Removing the Head FFC



- Make sure that the Pad is attached at the position in Figure 4-35..

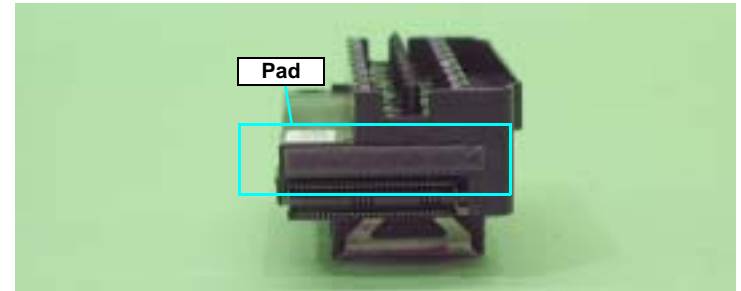

Figure 4-35. Attaching the Pad

- The Print Head must be installed with the Guide Pins of the Carriage Unit aligned with the positioning holes on the Print Head.

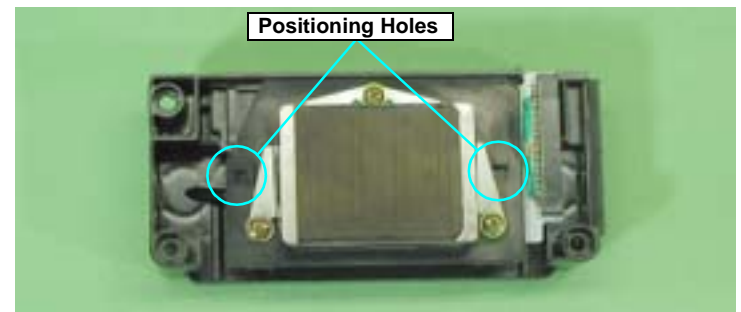
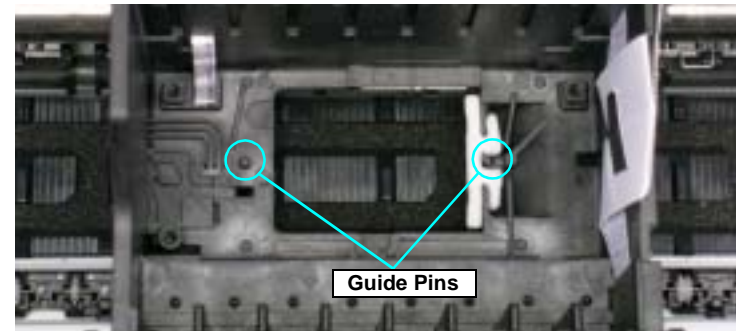

Figure 4-36. Reinstalling the Print Head (1)



- The screws must be tightened in the order shown in [Figure 4-33](#), while the Print Head is held down in the direction of the arrow.

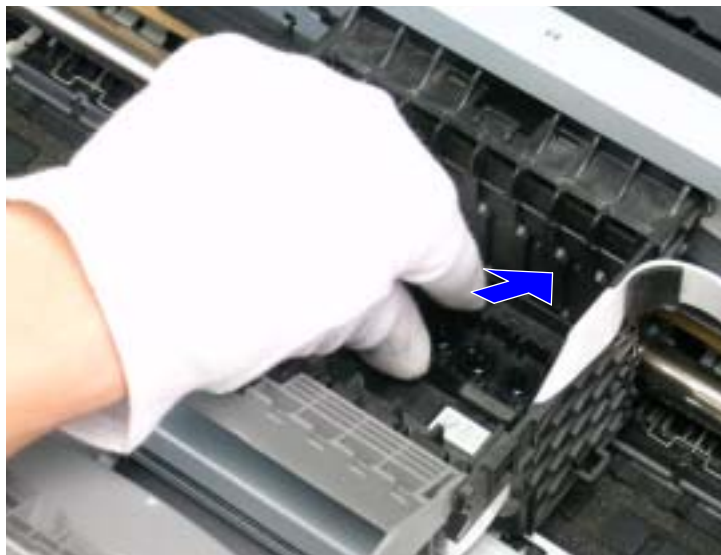

Figure 4-37. Reinstalling the Print Head (2)



After replacing or removing the Print Head, always make the following adjustments.

1. PG Adjustment
  2. Head ID Input (only after replacing)
  3. Ink Mark Sensor Adjustment
  4. Head Angular Adjustment
  5. Auto Bi-D Adjustment
  6. First dot position
  7. PW Sensor Adjustment
  8. Colorimetric Calibration (only after replacing)
- Refer to Chapter 5 "Adjustment" for details of the adjustments.

### 4.2.6.2 CR Scale

1. Remove the Upper Housing. [See Section 4.2.1.4 on page 76](#).
2. Release the Carriage lock, and move the Carriage Unit to the center. [See Section 4.2.1.3 on page 75](#).



When performing the following procedure, take care to prevent both ends of the CR Scale from being broken.

3. Pull the right end of the CR Scale in the direction of the arrow, and remove the CR Scale from the Tab on the Right CR Shaft Mounting Plate.
4. Draw out the right end of the CR Scale towards the left direction from the rear of the Carriage Unit.



Figure 4-38. Drawing Out the CR Scale

5. Remove the coil section of Torsion Spring 24.7 from the Tab on the Left CR Shaft Mounting Plate with tweezers.

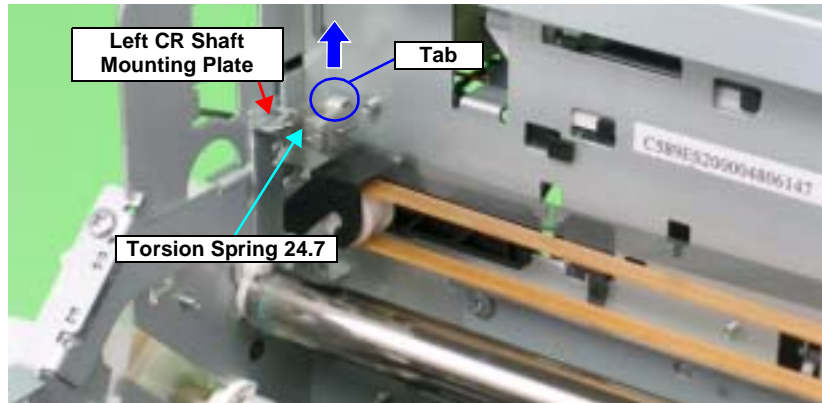

Figure 4-39. Removing the Torsion Spring 24.7 (1)

7. Turn the CR Scale 90°, and remove it from the Tab on the Left CR Shaft Mounting Plate.

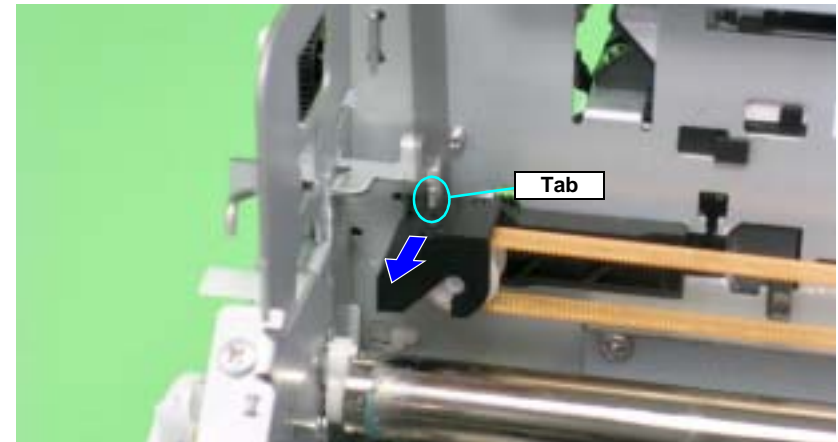

Figure 4-41. Removing the CR Scale

6. Remove Torsion Spring 24.7 from the CR Scale by the following procedure:
  - 6-1. Stand the coil section.
  - 6-2. Lower the coil section downwards to remove Foot 1 from the notch on the Left CR Shaft Mounting Plate.
  - 6-3. Turn the coil section counterclockwise.
  - 6-4. Remove Torsion Spring 24.7 from the hole on the CR Scale.

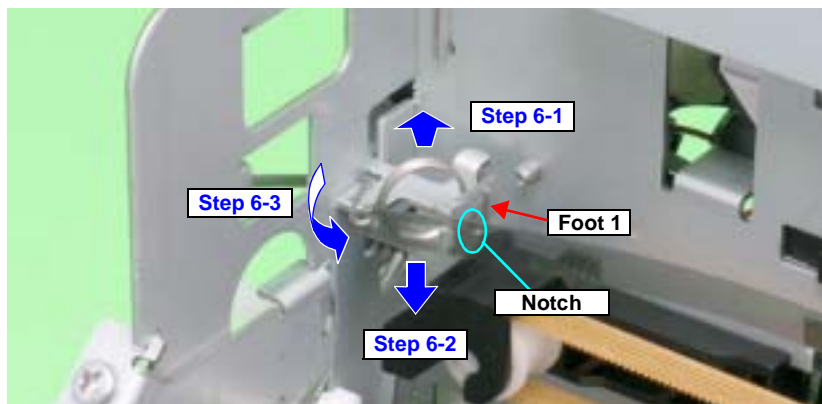

Figure 4-40. Removing the Torsion Spring 24.7 (2)





- Pass the CR Scale through the slot on the CR Encoder.

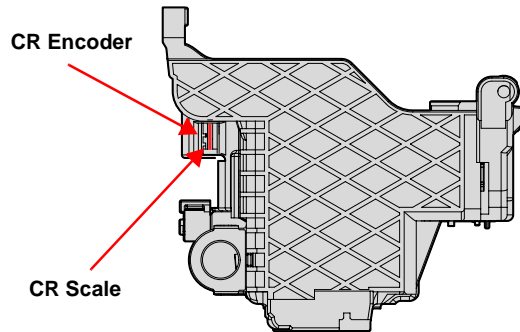

Figure 4-42. Reinstalling the CR Scale (1)

- Set the left end of the CR Scale with the chamfered edge facing upwards.

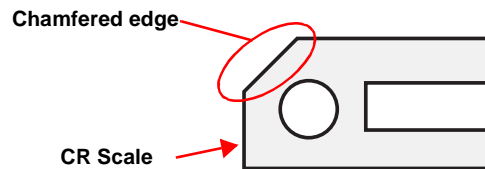

Figure 4-43. Reinstalling the CR Scale (2)

- Place the right end of the CR Scale correctly so that it is not hooked onto the Right CR Shaft Mounting Plate.

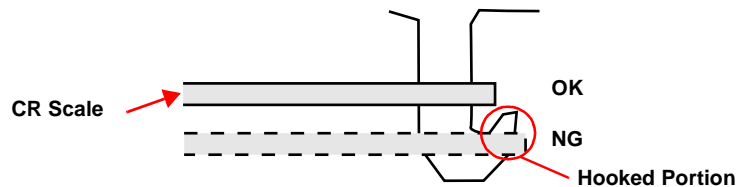

Figure 4-44. Reinstalling the CR Scale (3)

### 4.2.6.3 APG Assy

1. Remove the Upper Housing. See Section 4.2.1.4 on page 76.
2. Disconnect the APG Motor Connector Cable from Connector CN18 (red) on the Main Board, and Remove the Cable from the ASF Assy.
3. Disconnect the Connector Cables from the two APG Sensor Connectors.

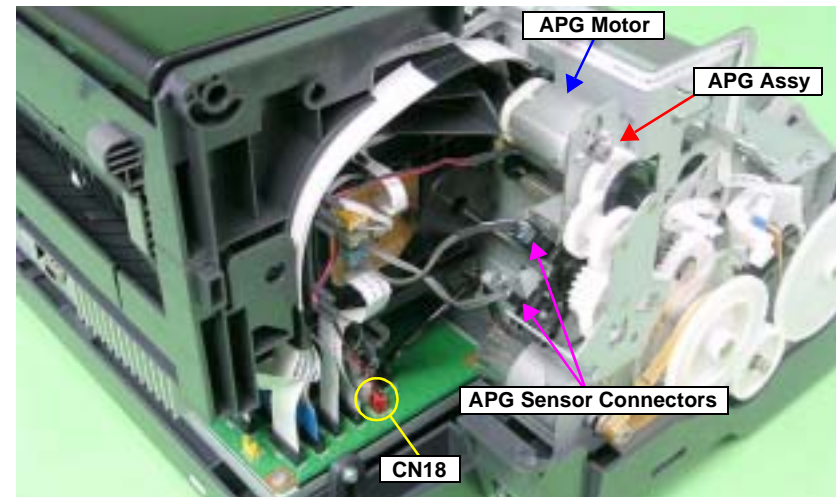

Figure 4-45. Disconnecting the Connector Cables



Referring to Figure 4-45., correctly route the APG Connector Cable.

- Remove the three C.B.S. M3 x 6 screws that secure the APG Assy, and remove the APG Assy from the Main Frame.

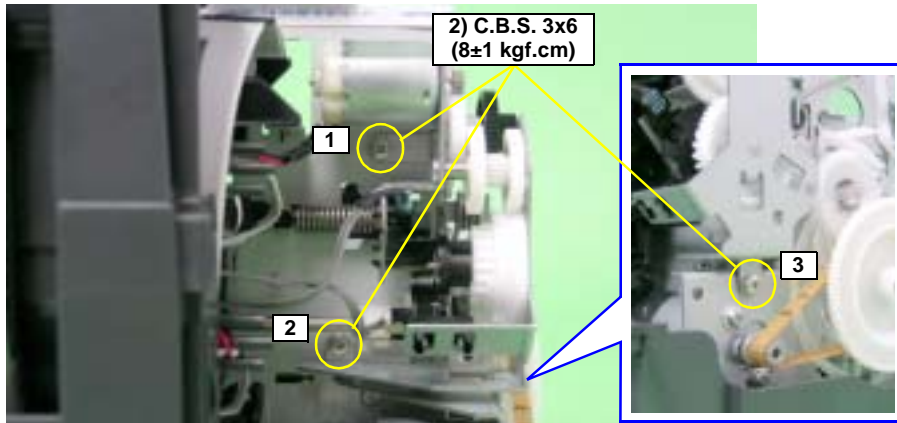
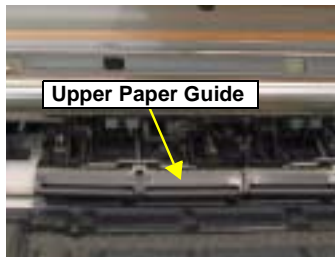

Figure 4-46. Removing the APG Assy



- When installing the APG Assy, make sure that the FLAG Release Assy is not in a released state (Upper Paper Guide down).



Released



Not Released

Figure 4-47. Reinstalling the APG Assy



- Match the phase of the APG Assy in the following procedure.

1. Match the delta marks of Spur Gear 16 and Combination Gear 22, 28.8, 32.4.

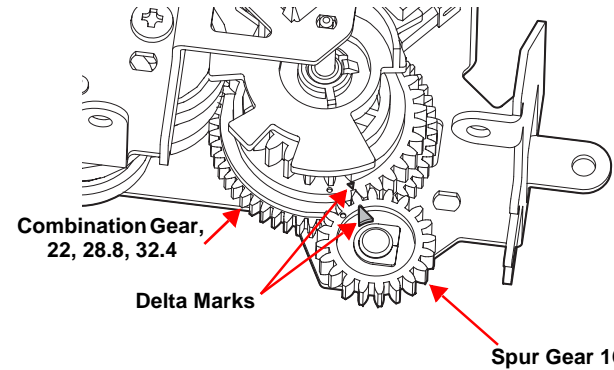

2. At the position where the Tab can be identified through the notch of the PG Frame, match the delta marks of Spur Gear 16 and PG Cam (Left).

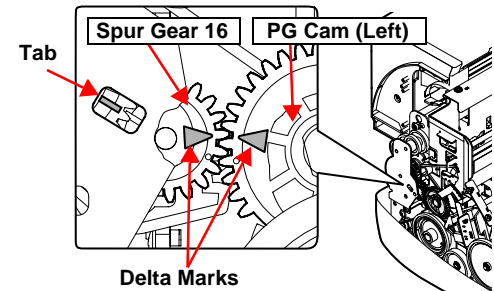

Figure 4-48. Phase Matching

- Tighten the screws in the order shown in [Figure 4-46](#).

#### 4.2.6.4 Carriage Shaft and Carriage Unit

1. Remove the LED Board. [See Section 4.2.5.2 on page 89.](#)
2. Remove the Print Head. [See Section 4.2.6.1 on page 89.](#)
3. Remove the CR Scale. [See Section 4.2.6.2 on page 91.](#)
4. Remove the APG Assy. [See Section 4.2.6.3 on page 93.](#)
5. Point any position other than PG++ on the PG Cam (Right) to face down.

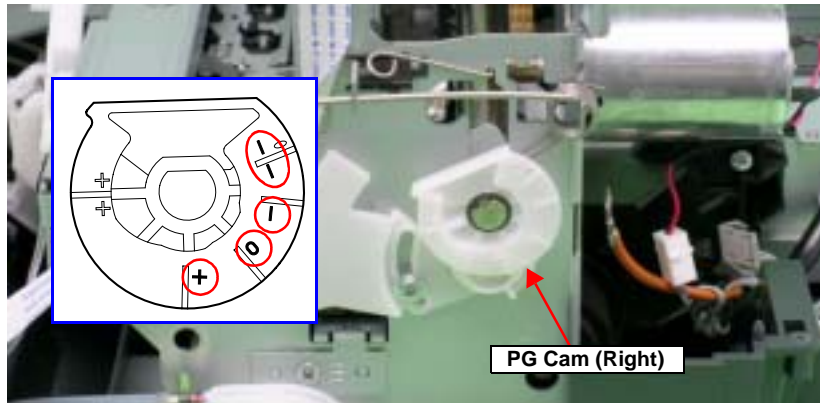

Figure 4-49. Setting the PG Cam

6. Remove the two C.B.S. M3 x 6 screws that secure the Frame Support Plate (Left), and remove it.

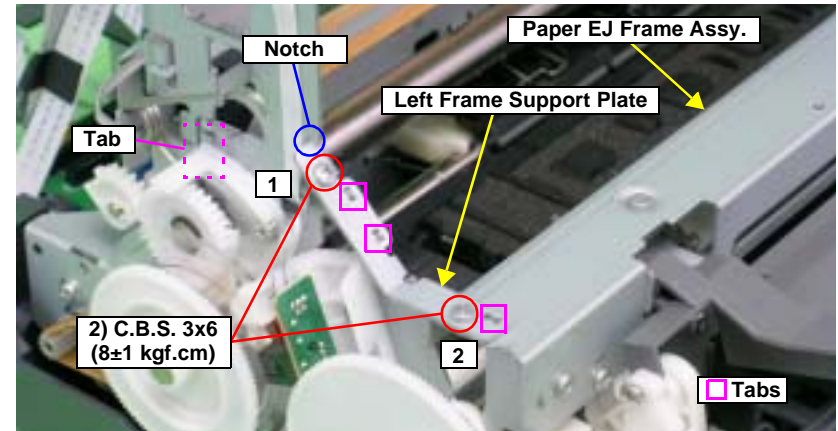

Figure 4-50. Removing the Left Frame Support Plate



- Insert the Left Frame Support Plate into the notch on the Main Frame. [See Figure 4-50.](#)
- Align the two Tabs on the Main Frame and the Tab on the Paper EJ Frame Assy with the three positioning holes on the Frame Support Plate (Left). [See Figure 4-50.](#)
- Align the Tab (rear side) of the Left Frame Support Plate with the outside of the Left CR Shaft Mounting Plate. [See Figure 4-50.](#)
- Tighten the screws in the order shown in [Figure 4-50.](#)



- Remove the foot of Left PG Torsion Spring from Tab A, and remove the coil section from Tab B to remove Left PG Torsion Spring from the Main Frame.

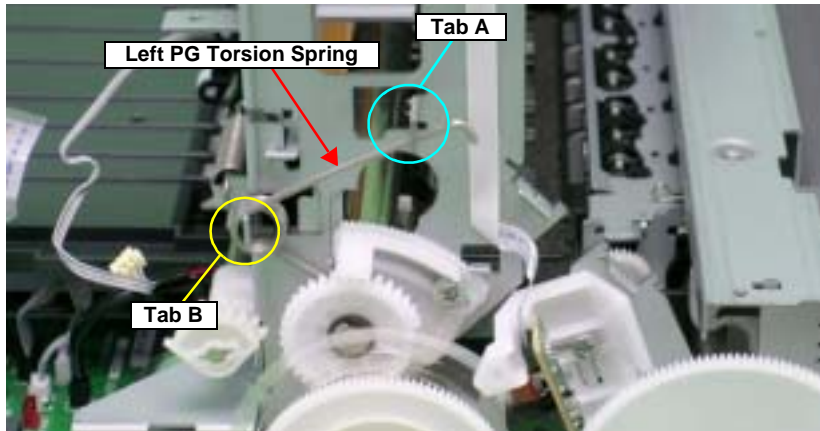

Figure 4-51. Removing Left PG Torsion Spring

- Remove the foot of Right PG Torsion Spring from Tab A, and remove the coil section from Tab B to remove Right PG Torsion Spring from the Main Frame.

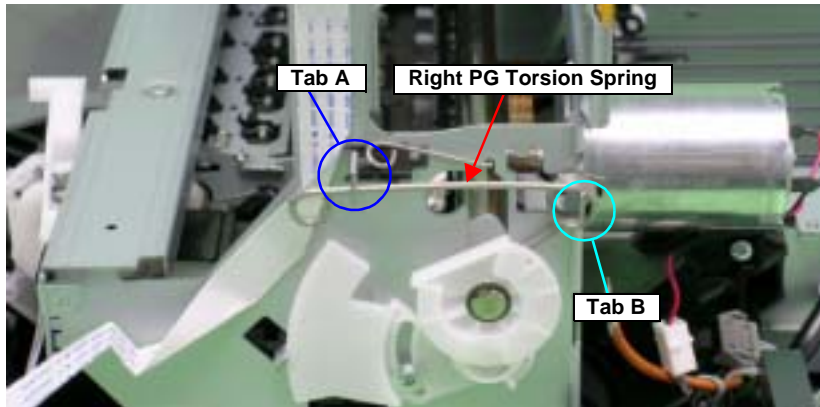

Figure 4-52. Removing Right PG Torsion Spring



Place the feet of Left PG Torsion Spring and Right PG Torsion Spring on the Carriage Shaft.

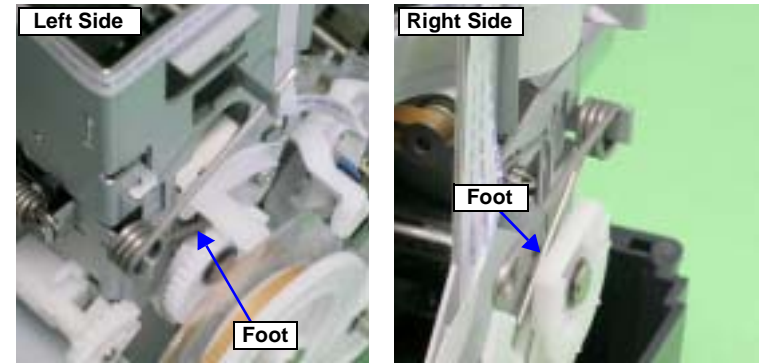

Figure 4-53. Reinstalling PG Torsion Springs

- Remove CR Shaft Mounting Plate Fixed Spring from the Tab and Notch on the Main Frame, and draw out the spring in the direction of the arrow.

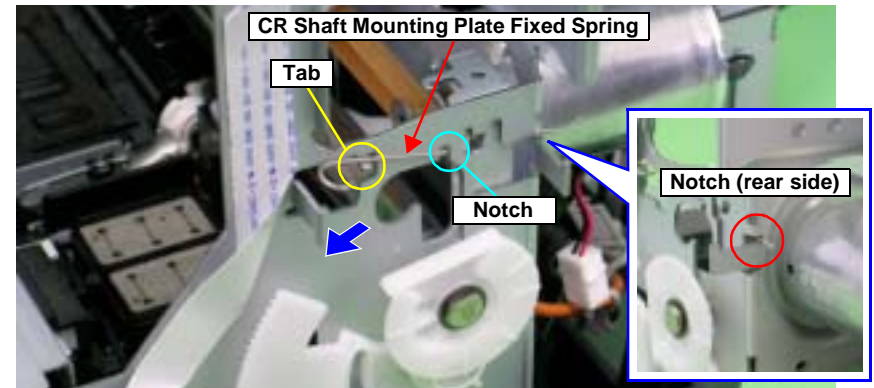

Figure 4-54. Removing CR Shaft Mounting Plate Fixed Spring



Insert the foot of CR Shaft Mounting Plate Fixed Spring into the notch on the Main Frame (rear side). See Figure 4-54.

- Remove the Extension Spring for the Driven Pulley Holder from the Main Frame and the Tab on the Drive Pulley Holder with needle-nose pliers.

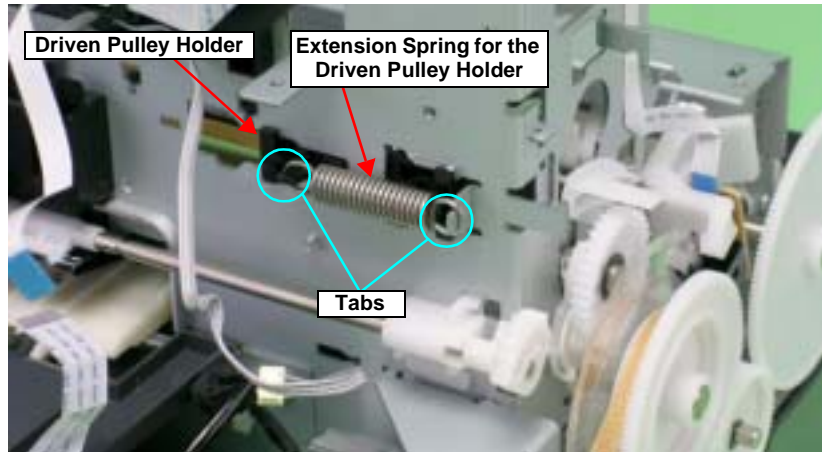

Figure 4-55. Removing the Extension Spring for the Driven Pulley Holder

- Remove the Driven Pulley Holder toward you after sliding it to the right end of the notch on the Main Frame.

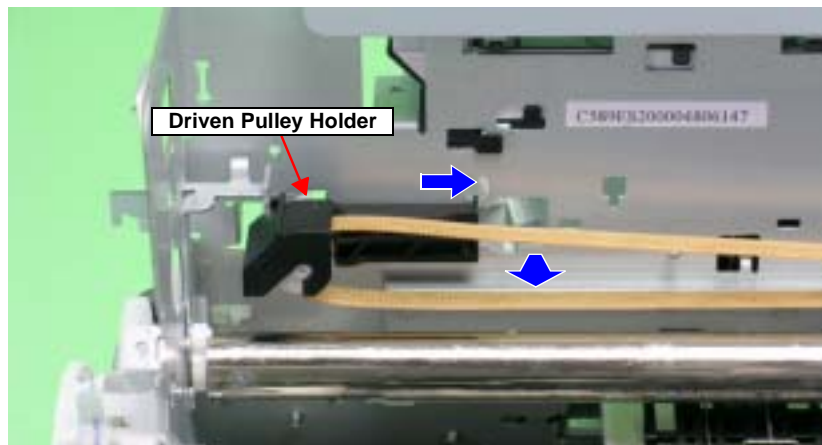

Figure 4-56. Removing the Driven Pulley Holder

- Remove the CR Drive Belt from the CR Motor Pinion Gear.

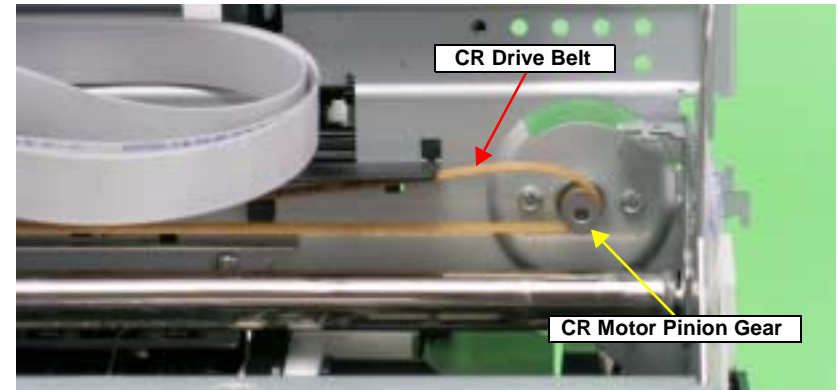

Figure 4-57. Removing the CR Drive Belt

- Remove the four C.B.S. (P4) M3 x 6 screws that secure the CR Guide Plate, and remove it from the Main Frame.

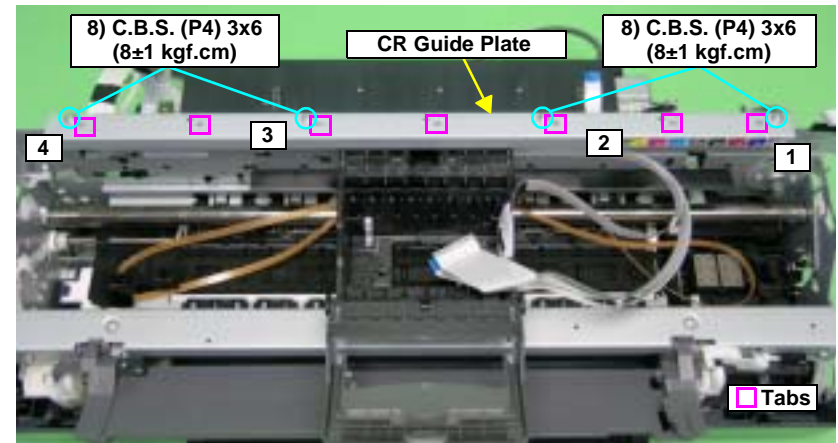

Figure 4-58. Removing the CR Guide Plate



- Align the positioning holes on the CR Guide Plate with the seven Tabs on the Main Frame. See Figure 4-58.
- Tighten the screws in the order shown in Figure 4-58.

- Loosen the C.B.S. (P4) M3 x 8 screw that secures the Left Parallelism Adjust Bushing, and rotate the Bushing toward the front of the Printer Mechanism to prevent interference between the Flag of the Parallelism Adjust Bushing and the Left PG Cam.

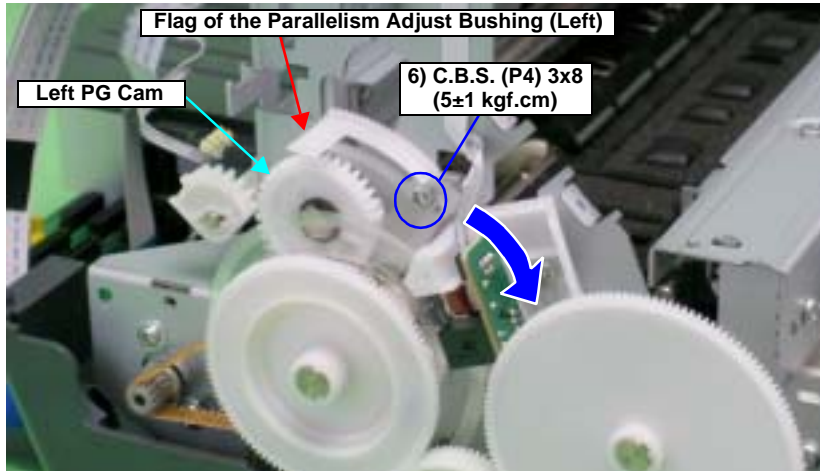

Figure 4-59. Rotating the Left Parallelism Adjust Bushing

- Slide the Left CR Shaft Mounting Plate upwards, and release the Tab on the Left CR Shaft Mounting Plate from the notch on the Main Frame to rotate the Mounting Plate toward you.

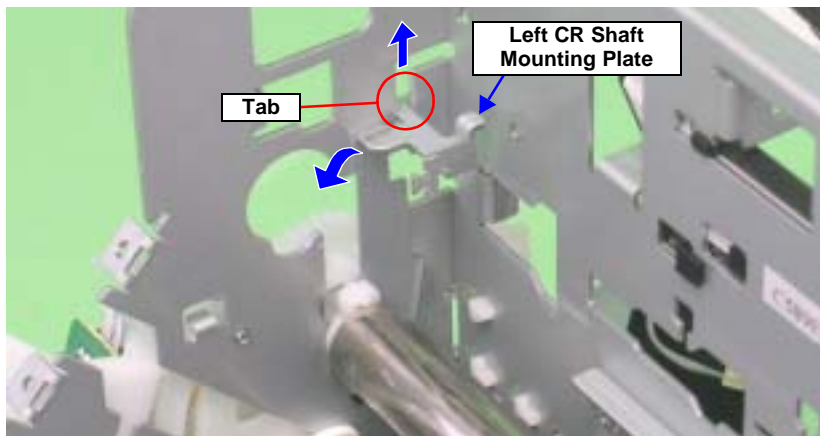

Figure 4-60. Rotating the Left CR Shaft Mounting Plate

- Lift the Carriage Shaft upwards, and remove the Carriage Shaft Spacer from the Carriage Shaft with tweezers.

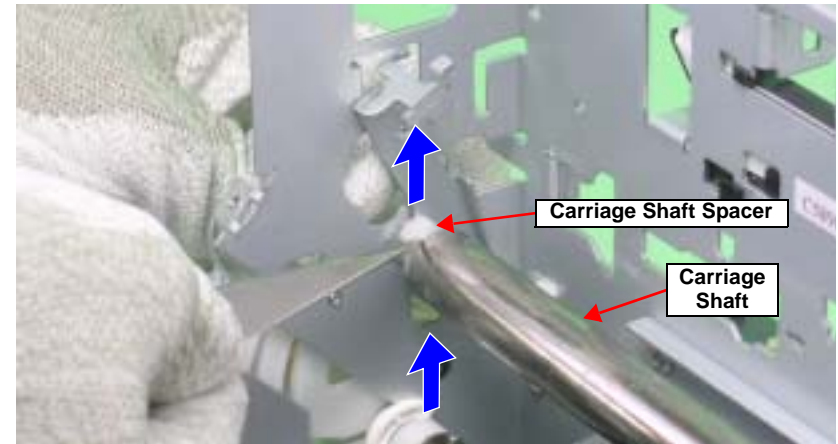

Figure 4-61. Removing the Carriage Shaft Spacer

- Rotate the Left CR Shaft Mounting Plate toward you to remove the Bushing on the Left CR Shaft Mounting Plate from the Carriage Shaft.

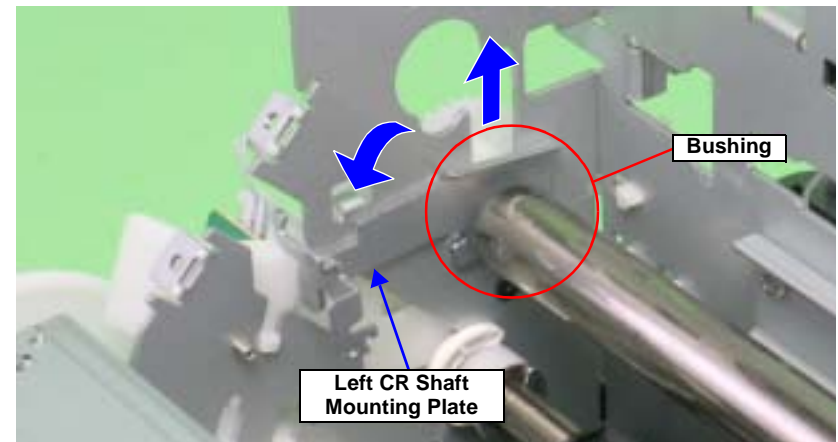

Figure 4-62. Removing the Left CR Shaft Mounting Plate



- Lift the Carriage Shaft within the hole on the Main Frame, and remove the Spacer and Left PG Cam from the Carriage Shaft.

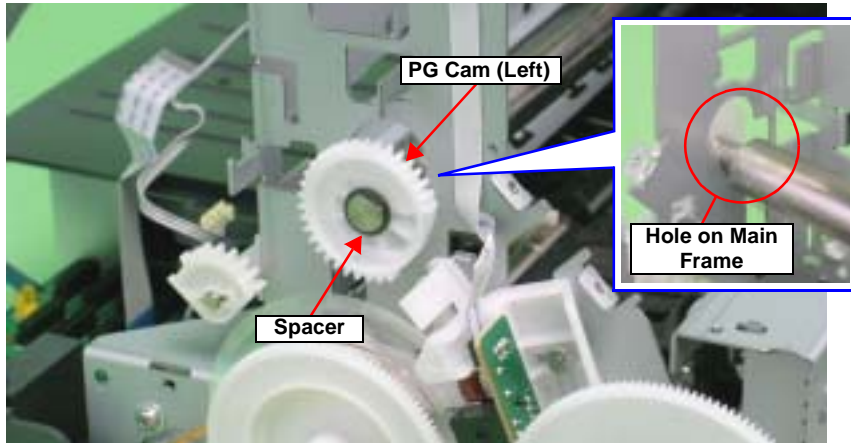

Figure 4-63. Removing Left PG Cam

- Remove the Spacer and Right PG Cam from the Carriage Shaft.

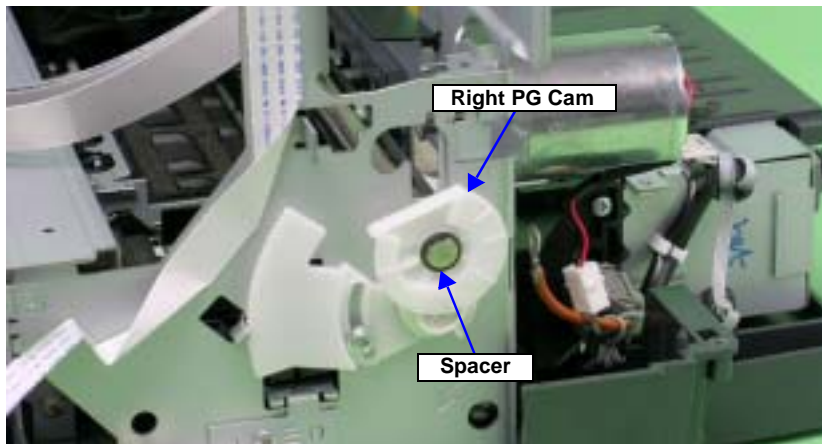

Figure 4-64. Removing Right PG Cam



Install the Right PG Cam so that one of these positions marked "0", "+" or "++" faces downward.

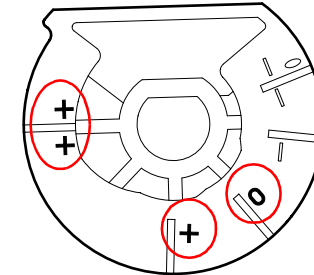

Figure 4-65. Right PG Cam Installation Direction

- Pull the Right CR Shaft Mounting Plate away from the Tab on the Main Frame and rotate toward you.

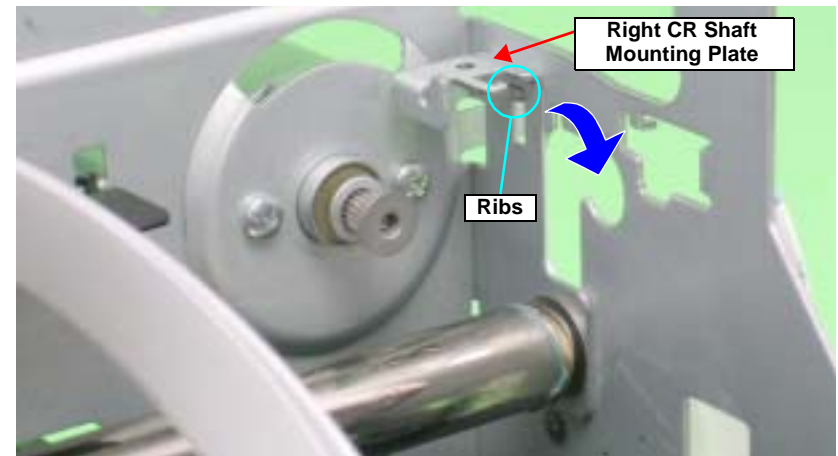

Figure 4-66. Rotating the Right CR Shaft Mounting Plate



**When performing the following procedure, take care not to scratch the Carriage Shaft.**

21. Slide the Carriage Unit to the left side to prevent the CR Scale Cover from interfering with the rear of the Carriage Unit, slide the Carriage Shaft to the left side and draw out its right end from the Main Frame, and draw out the Carriage Shaft from the Main Frame and Carriage Unit.

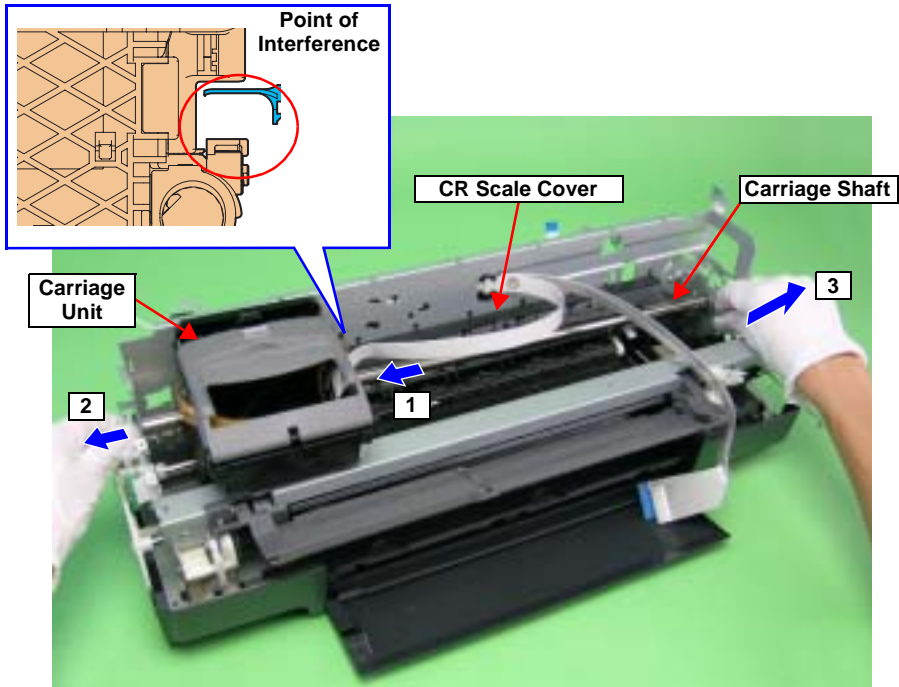

Figure 4-67. Removing the Carriage Shaft



- Set the longer end of the Carriage Shaft to the left side.
- When the Carriage Shaft is removed, the Plain Spring and Leaf Spring that are attached to the right end of the Carriage Shaft may drop off. In such case, be sure to attach them in the order as shown in the figure below.

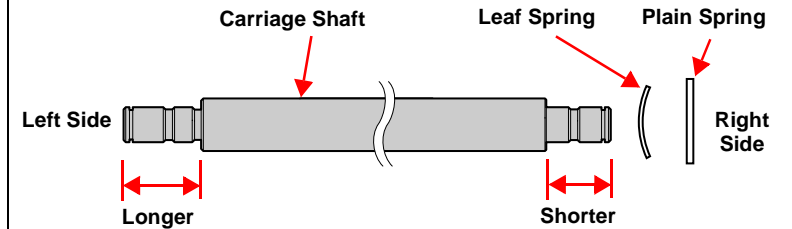

Figure 4-68. Reinstalling the Carriage Shaft

22. Remove the CR Drive Belt from the Carriage Unit.



Figure 4-69. Removing the CR Drive Belt



Referring to the figure below, install the CR Drive Belt so that its top and rear sides face the correct way.

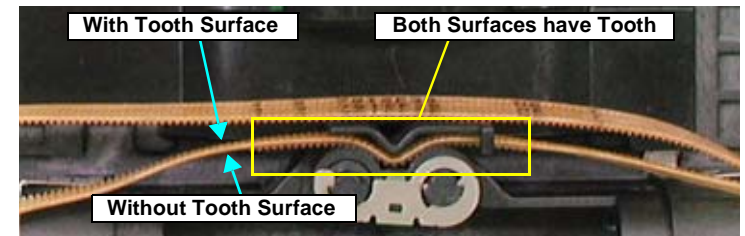

Figure 4-70. Reinstalling the CR Drive Belt



23. Turn the Belt Holder Mounting Plate in the direction of the arrow, and remove it from the Carriage Unit.

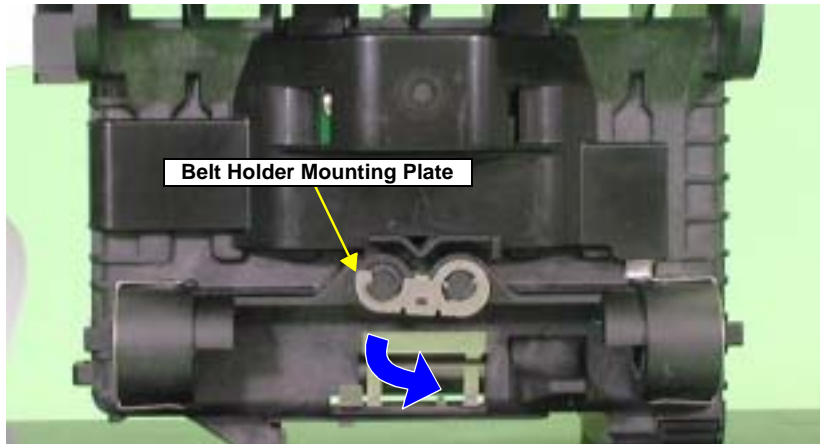

Figure 4-71. Removing the Belt Holder (1)

24. Remove the Belt Holder from the Carriage unit.

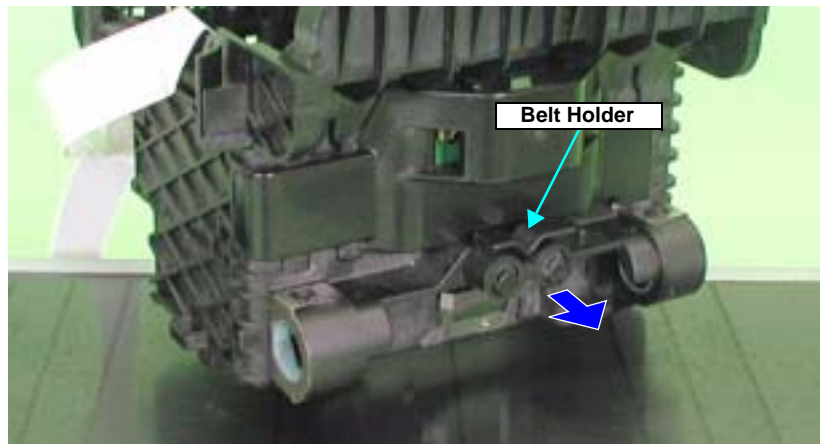

Figure 4-72. Removing the Belt Holder (2)

25. Release the CR Encoder Board Holder from the three Tabs to remove it from the Carriage Unit.

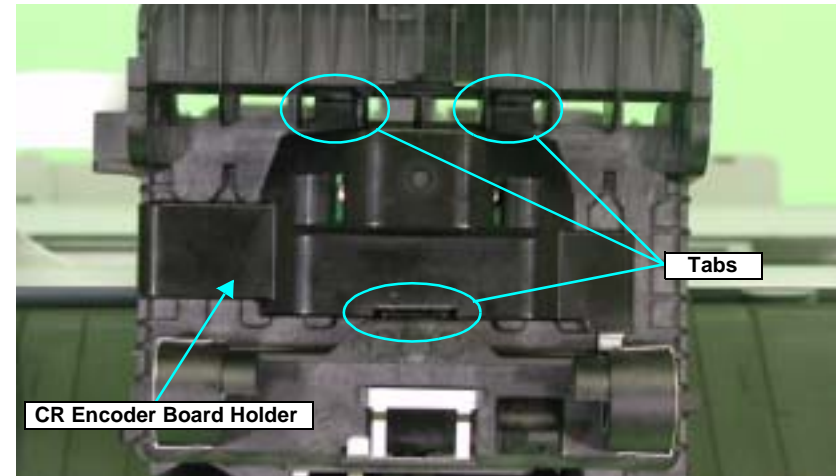

Figure 4-73. Removing the CR Encoder Board Holder

26. Disconnect the Sensor FFC from the Connector on the CSIC Board.

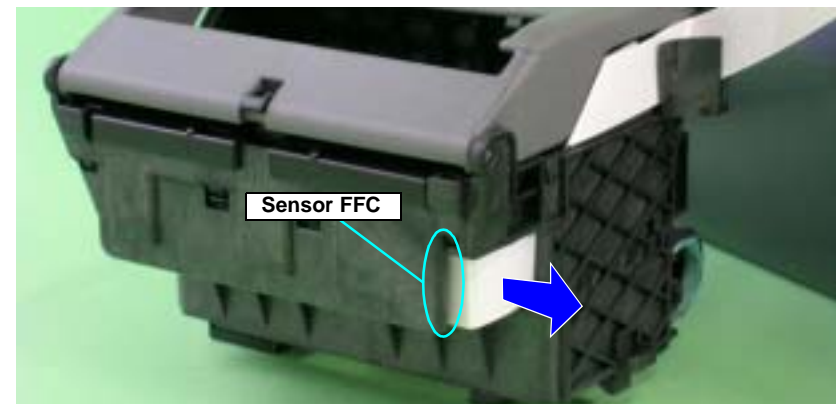

Figure 4-74. Removing the Sensor FFC

27. Disconnect the Sensor FFC from the Connector on the CR Encoder Board, draw out the Sensor FFC from the Carriage Unit, and remove the Carriage Unit.

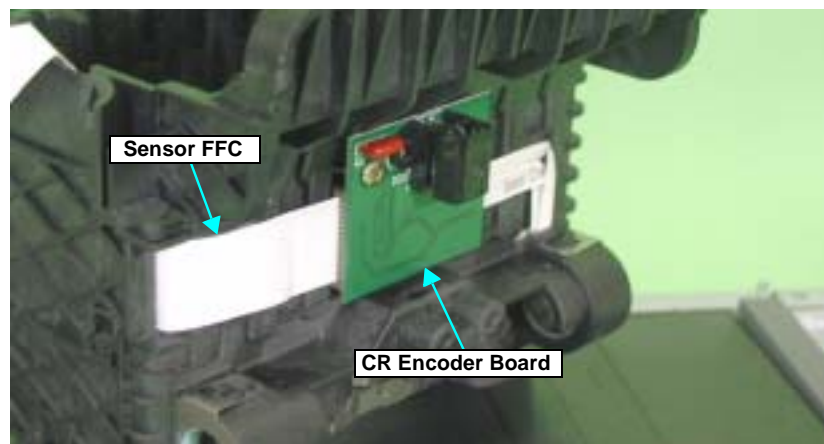

Figure 4-75. Removing the Carriage Unit



- When the Carriage Unit is removed from the Printer Mechanism, the CR Pad may drop off. In such case, correctly install it referring to the figure below.

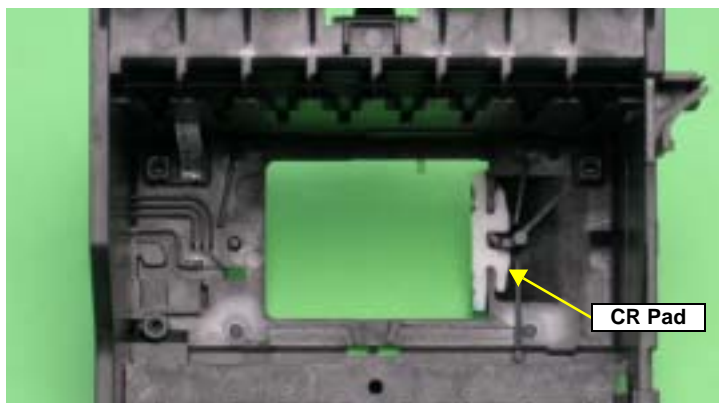

Figure 4-76. Reinstalling the CR Pad

ADJUSTMENT  
REQUIRED



After replacing the parts listed below, be sure to apply G-26 or G-71 grease to the area specified for each part.

- Left and Right Parallelism Adjust Bushing  
See Figure 6-2 on page 175.
- Left and Right CR Scale Mounting Plate  
See Figure 6-3 on page 175.
- Left and Right PG Cam  
See Figure 6-5 on page 176.
- Left and Right PG Torsion Spring  
See Figure 6-6 on page 176.
- CR Guide Plate  
See Figure 6-7 on page 176.
- Driven Pulley Hoder  
See Figure 6-8 on page 177.
- Carriage Shaft  
See Figure 6-4 on page 176. and Section 6.1.4.1 on page 178.

ADJUSTMENT  
REQUIRED



Be sure to perform the following adjustments after the Carriage Shaft and Carriage Unit are replaced or removed:

1. PG Adjustment
2. Ink Mark Sensor Adjustment
3. Head Angular Adjustment
4. Auto Bi-D Adjustment
5. First dot position
6. PW Sensor Adjustment

Refer to Chapter 5 "Adjustment" for details of the adjustments.

#### 4.2.6.5 CSIC Board

1. Remove the Upper Housing. See Section 4.2.1.4 on page 76.
2. Release the Carriage lock, and move the Carriage Unit to the center. See Section 4.2.1.3 on page 75.
3. Open the Ink Cartridge Cover.
4. Remove the Guide Pin that secures the Ink Cartridge from the Carriage Unit with a flat-blade screwdriver, and remove the Ink Cartridge Cover.

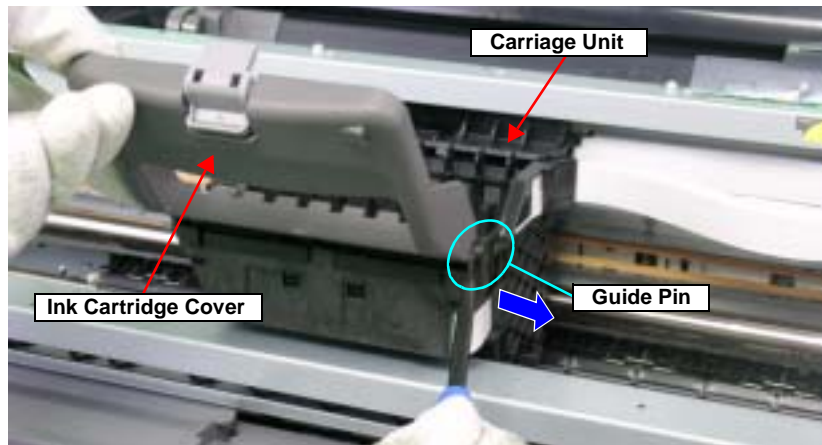

Figure 4-77. Removing the Ink Cartridge Cover



- Align the positioning holes on the Carriage Unit with the two Guide Pins on the Ink Cartridge Cover.
- Make sure that the shaft on the center of the Ink Cartridge Cover fits into the Bushing on the Carriage Unit.

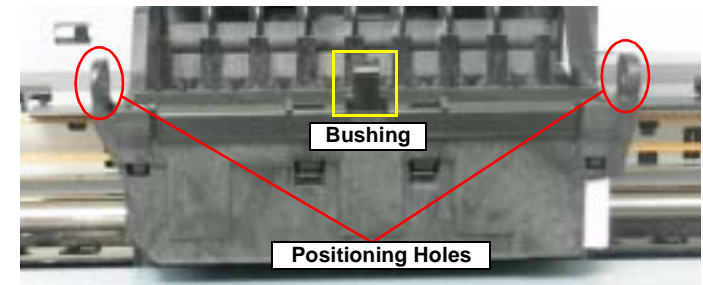
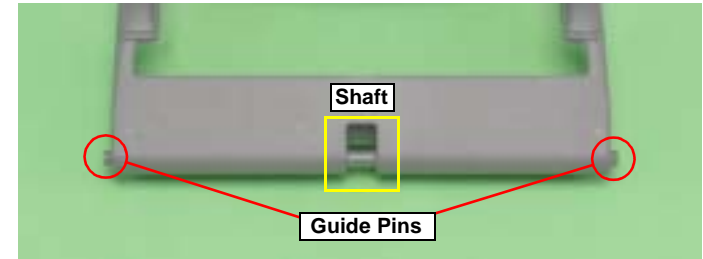

Figure 4-78. Reinstalling Ink Cartridge Cover

- Release the CSIC Board Cover from the four Tabs with a flat-blade screwdriver, and remove the CSIC Board Cover from the Carriage Unit.

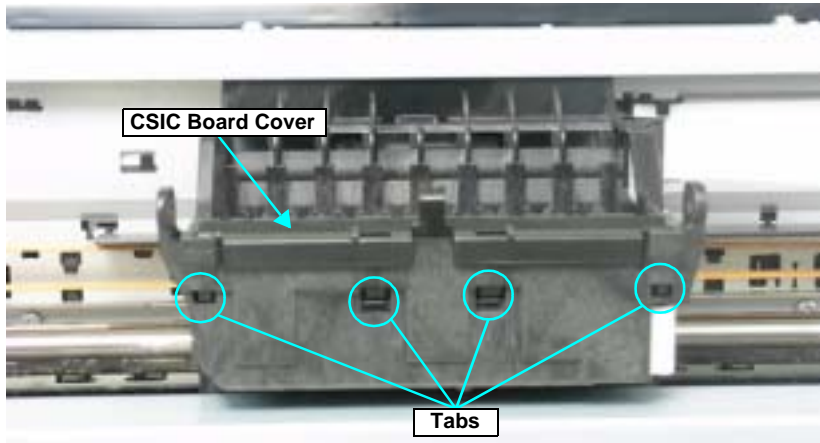

Figure 4-79. Removing the CSIC Board Cover

- Disconnect the Sensor FFC from the CSIC Board Connector. See Step 26 in Section 4.2.6.4 on page 101.
- Hold the CSIC Board Spacer with your fingers and remove upwards.

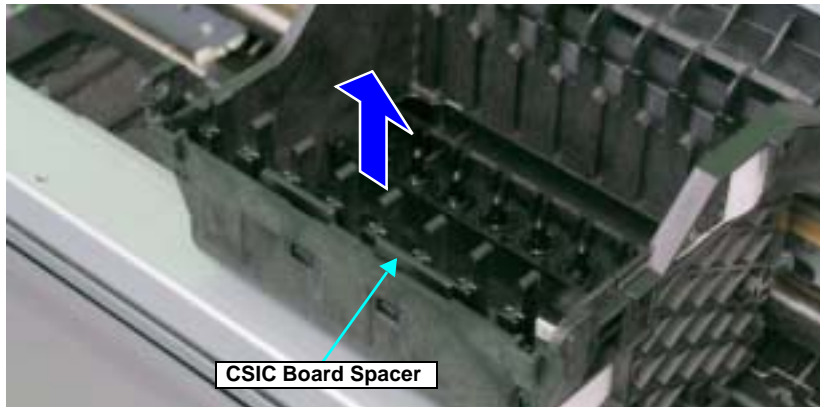

Figure 4-80. Removing the CSIC Board Spacer

- Push up the CSIC Board with a flat-blade screwdriver from the notch on the right side of the Carriage Unit, and remove the CSIC Board from the Carriage Unit.

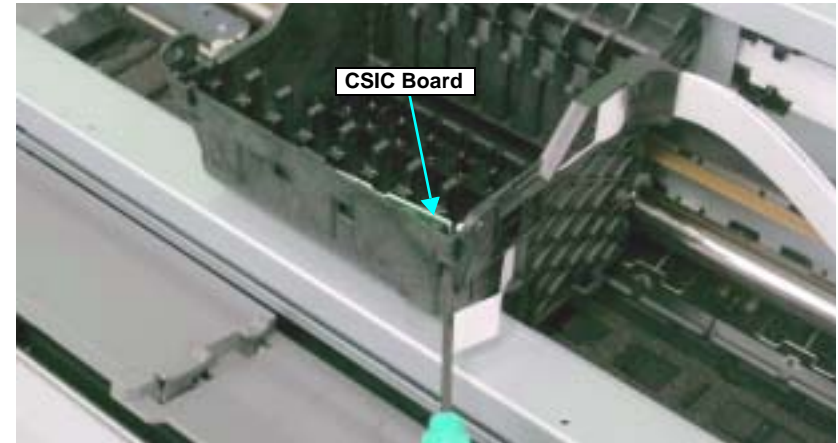

Figure 4-81. Removing CSIC Board



The CSIC Board Spacer must be installed at the position indicated in the figure below.

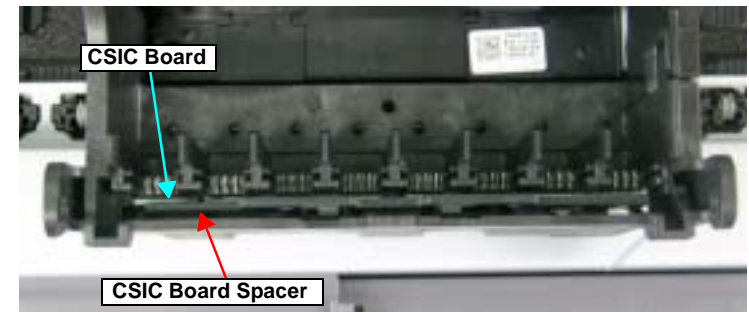

Figure 4-82. Reinstalling the CSIC Board Spacer



### 4.2.6.6 Paper EJ Frame Assy.

1. Remove the Upper Housing. See Section 4.2.1.4 on page 76.
2. Remove the CD-R Unit Housing from the CD-R Tray Base by releasing the Housing from two attaching points to the Tray Base.
3. Remove the Left Frame Support Plate. See Step 5 and Step 6 in Section 4.2.6.4 on page 95.
4. Return the rotation position of the Right PG Cam.
5. Remove the four C.B.S. M3 x 6 screws and two C.B.P. M3 x 8 screws that secure the Paper EJ Frame Assy.

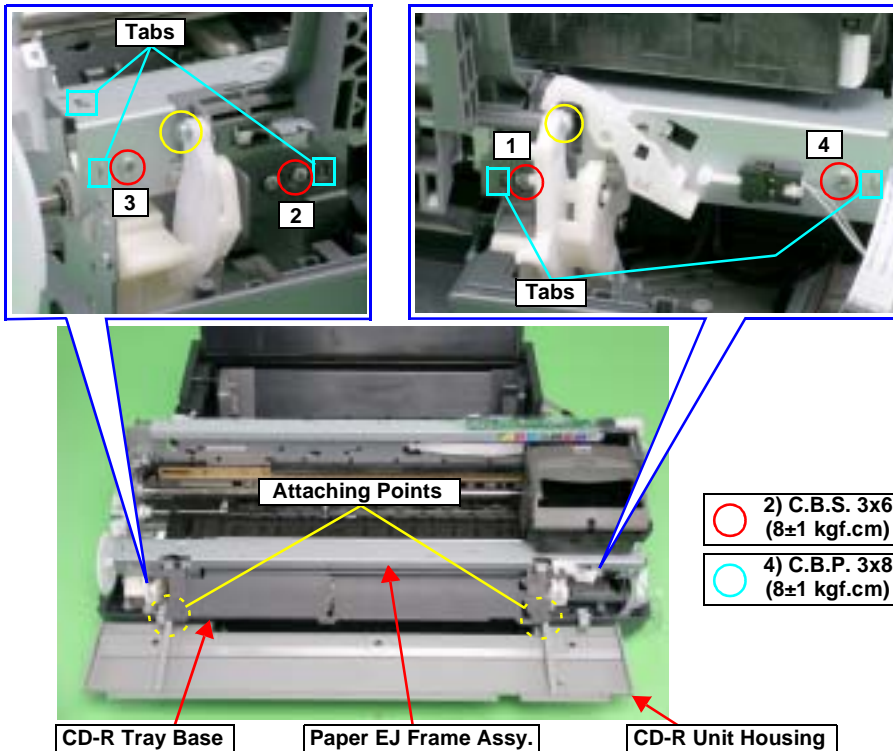

Figure 4-83. Screws that Secure the Paper EJ Frame Assy



When performing the following procedure, take care not to scratch the Star Wheel.

6. Remove the two Guide Pins on the CD-R Tray Base from the Left and Right CD-R Release Lever Sub Assy.
7. Pull the Star Wheel Roller toward you, and remove the Paper EJ Frame Assy from the Printer Mechanism keeping the Assy from coming in contact with the Right CD-R Release Lever Sub Assy and the Tab on the Right CD-R Cover.

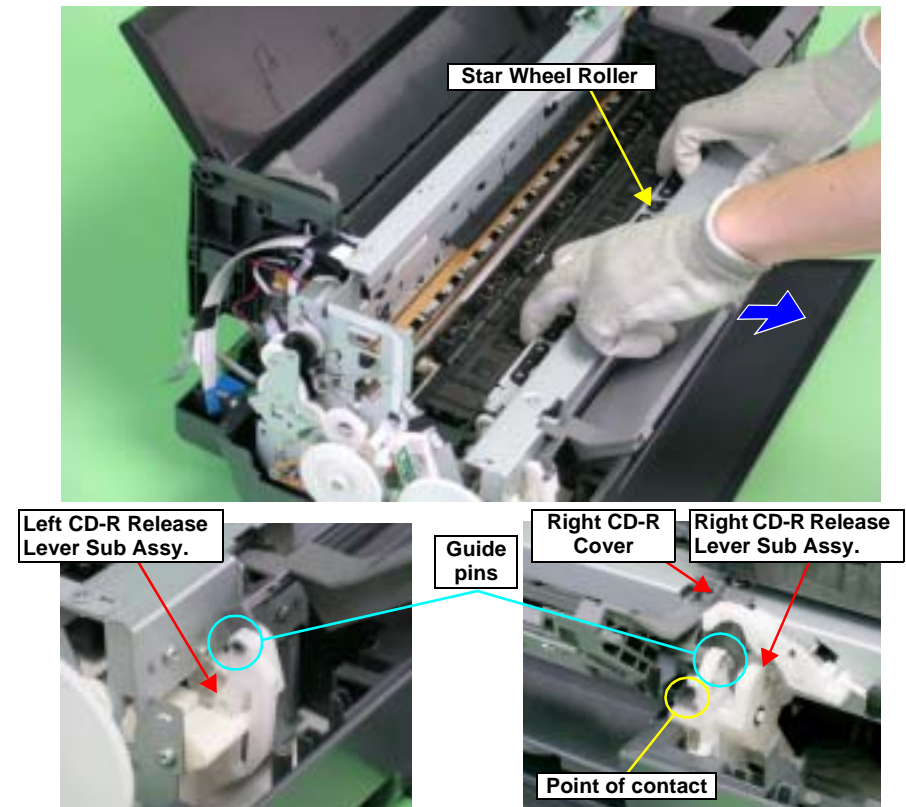

Figure 4-84. Removing the Paper EJ Frame Assy.



- Hook both rear ends of the Paper EJ Frame Assy onto the Tabs on the Main Frame.
- Align the Bearing of the CD-R Release Level Sub Assy with the Paper EJ Release Shaft.

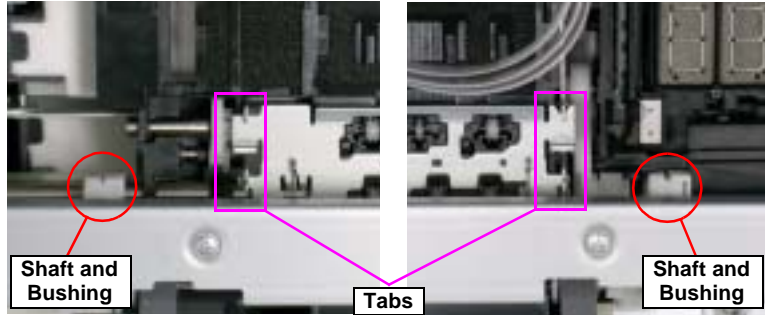

Figure 4-85. Reinstalling the Paper EJ Frame Assy.

- Match the Tabs with the five Positioning Holes. See Figure 4-83.
- Tighten the screws in the order shown in Figure 4-84.



Be sure to perform the following adjustments when the Paper EJ Frame Assy is replaced or removed:

1. Ink Mark Sensor Adjustment
2. PW Sensor Adjustment
3. PF Adjustment
4. PF Adjustment (Bottom Margin)

Refer to Chapter 5 "Adjustment" for details of the adjustments.

#### 4.2.6.7 CD-R Release Lever Sub Assy

1. Remove the Printer Mechanism. See Section 4.2.1.5 on page 78.
2. Remove the Paper EJ Frame Assy. See Section 4.2.6.6 on page 105.
3. Remove the Shaft on the Right CD-R Release Base from the Bushing on the CD-R Release Lever.

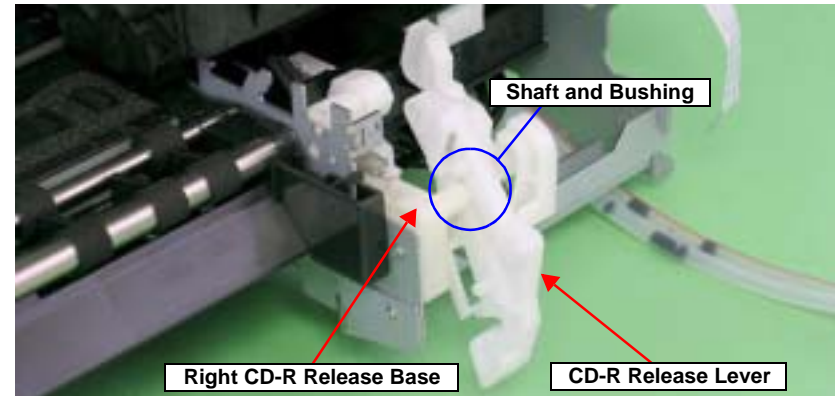

Figure 4-86. Removing the Right CD-R Release Lever Sub Assy (1)

4. Remove the C.B.S. M3 x 6 screw that secures the Right CD-R Release Lever Sub Assy.

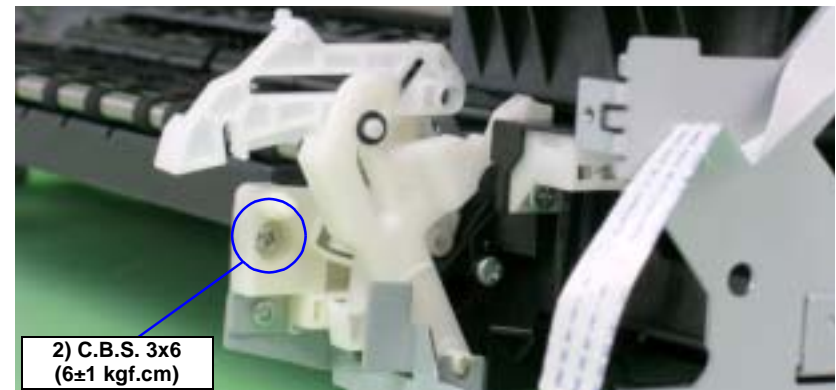

Figure 4-87. Removing the Right CD-R Release Lever Sub Assy (2)

5. To prevent parts from dropping, refit the shaft on the Right CD-R Release Base into the CD-R Release Lever.
6. Press the Guide Pin that secures the Right CD-R Release Lever Sub Assy with tweezers, and remove it upwards from the Main Frame.

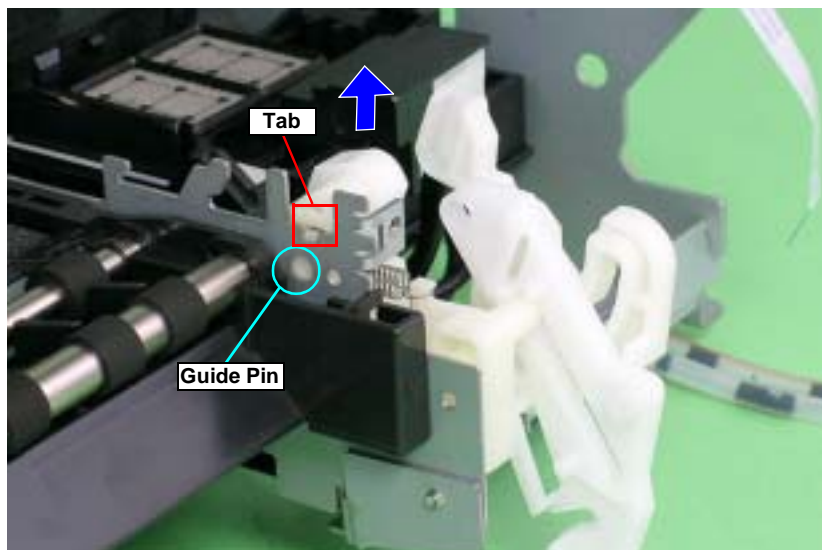

Figure 4-88. Removing the Right CD-R Release Lever Sub Assy (3)



- Make sure that the Right CD-R Release Lever Sub Assy is correctly assembled as shown in the figure below.



Figure 4-89. Reassembling the Right CD-R Release Lever Sub Assy

- Align the Shaft and Bushing.

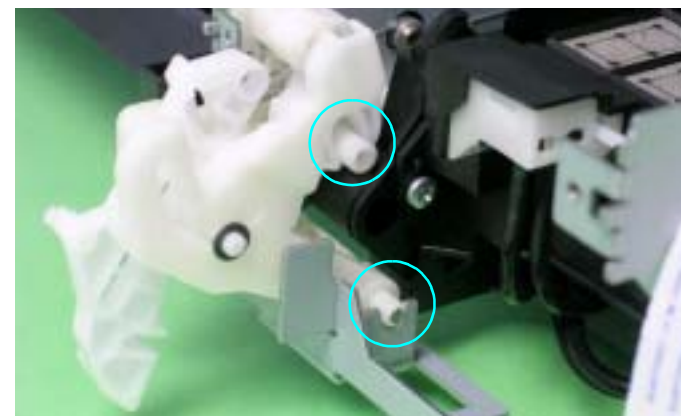

Figure 4-90. Reinstalling the Right CD-R Release Lever Sub Assy

- Align the positioning hole of the Right CD-R Release Lever Sub Assy with the Tab on the Main Frame. See [Figure 4-88](#).



- Remove Spur Gear 68 from the Paper EJ Roller Shaft.



Figure 4-91. Removing the Spur Gear 68

- Remove the C.B.P. M3 x 6 screw that secures the Left CD-R Release Lever Sub Assy.
- Press the small Tab of the Left CD-R Release Lever Sub Assy with a flat-blade screwdriver, and remove the Left CD-R Release Lever Sub Assy upwards from the Main Frame.

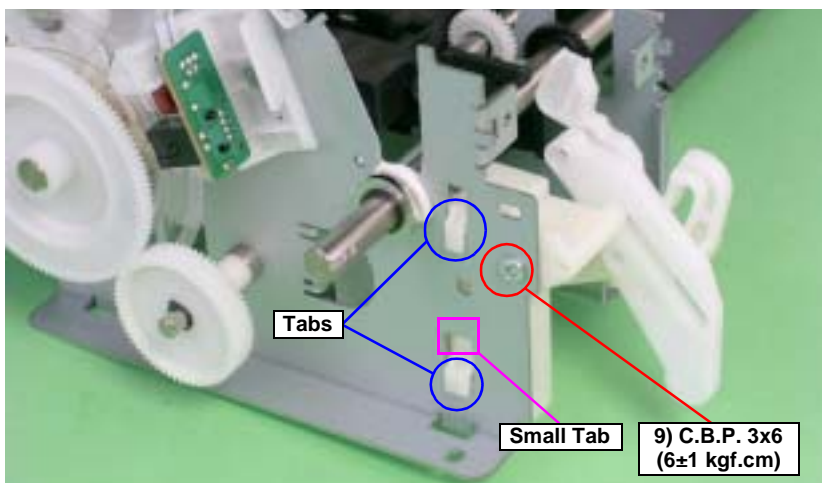

Figure 4-92. Removing the Left CD-R Release Lever Sub Assy



- Make sure that the Left CD-R Release Lever Sub Assy is correctly assembled as shown in the figure below.



Figure 4-93. Reinstalling the Left CD-R Release Lever Sub Assy (1)

- Align the Shaft and Bushing.



Figure 4-94. Removing the Left CD-R Release Lever Sub Assy (2)

- Align the two Tabs on the Left CD-R Release Lever Sub Assy with the positioning holes on the Main Frame. See [Figure 4-92](#).



### 4.2.6.8 Ink System Unit

1. Remove the Right CD-R Release Lever SubAssy. See Section 4.2.6.7 on page 106.
2. Release the Carriage lock, and move the Carriage Unit to the center. See Section 4.2.1.3 on page 75.
3. Remove the C.B.S. M3 x 8 screw that secures the Earth Cable to remove the Earth Cables, and untie the Earth Cable from the Relay Connector Cable.
4. Disconnect the Pump Motor Connector from the Relay Connector.

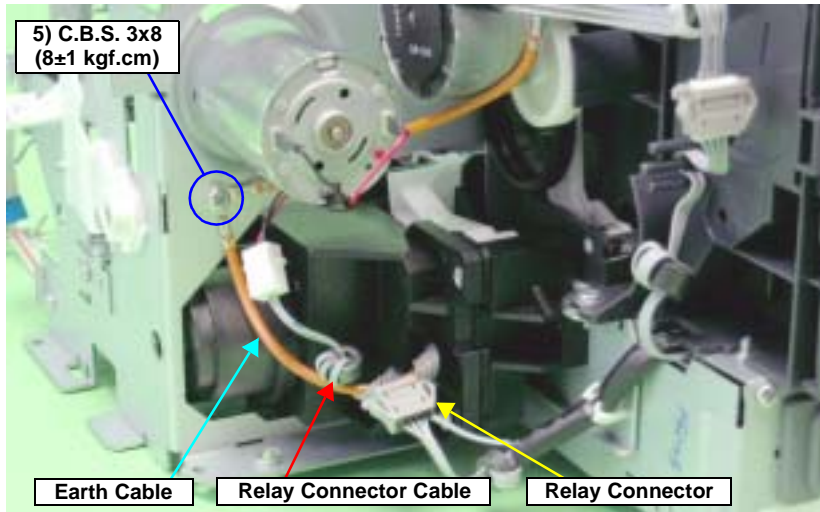

Figure 4-95. Disconnecting the Pump Motor Connector



- Be sure to screw the two Earth Cables together.
- Referring to Figure 4-95., correctly route the Relay Connector Cable.

5. Remove the two C.B.S. M3 x 4 screws that secure the Ink System Guide Plate, and remove it.

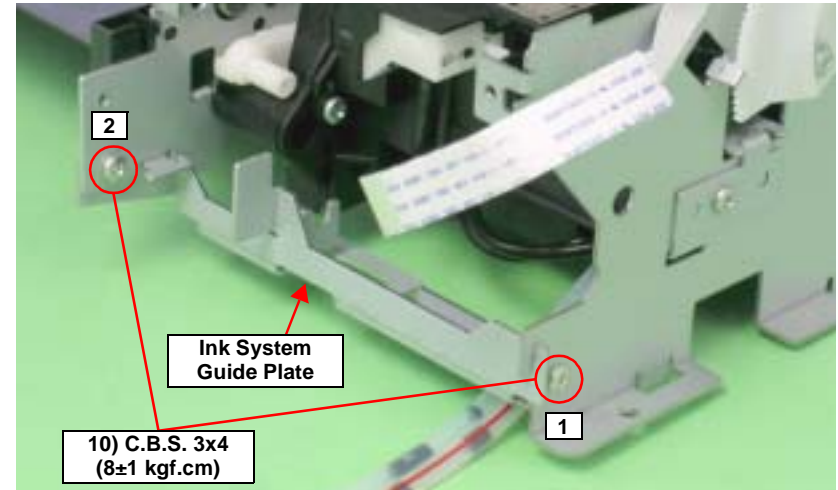

Figure 4-96. Removing the Ink System Guide Plate



- Align the notch on the Ink System Guide Plate with the notch on the Main Frame.

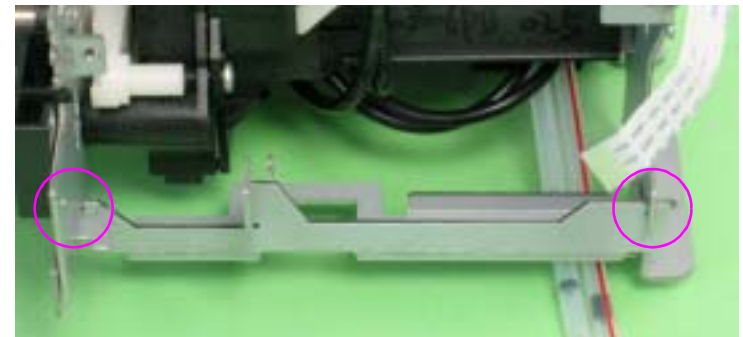

Figure 4-97. Reinstalling the Ink System Guide Plate

- Tighten the screws in the order shown in Figure 4-96.

- Remove the two C.B.S. M3 x 6 screws that secure the Ink System Unit.

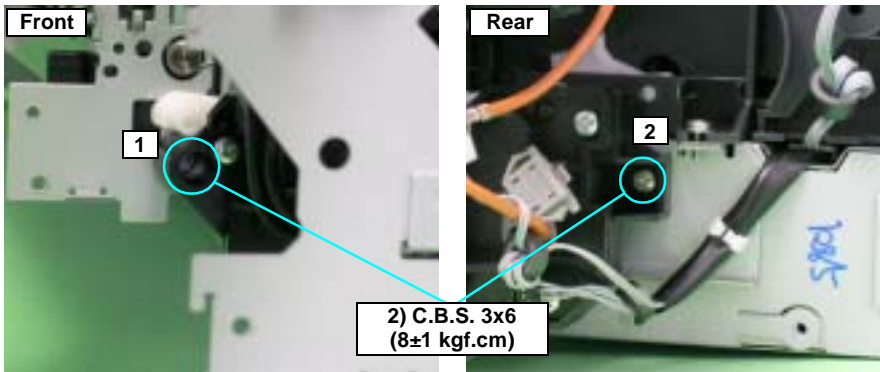

Figure 4-98. Screws that Secure the Ink System Unit



Tighten the screws in the order shown in [Figure 4-98](#).

- Remove the two C.B.S. M3 x 6 screws that secure the Right Support Frame, and remove the Right Support Frame from the Main Frame.

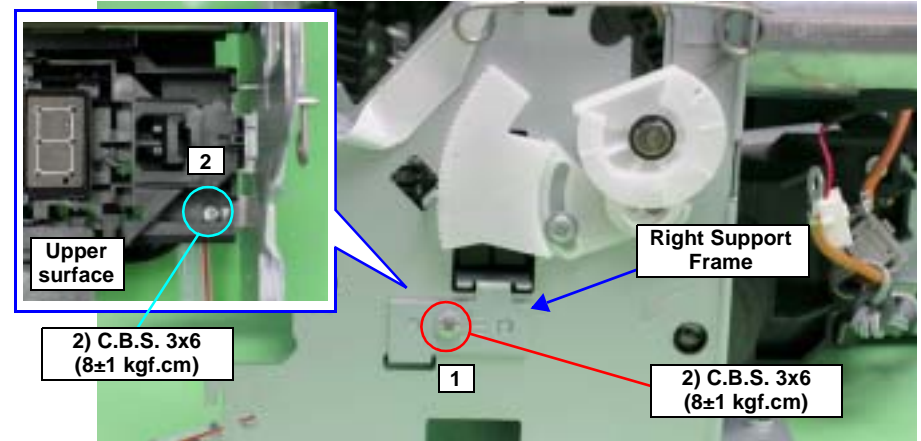

Figure 4-99. Removing the Right Support Frame



- Align the positioning holes on the Right Support Frame with the Guide Pins on the Main Frame.

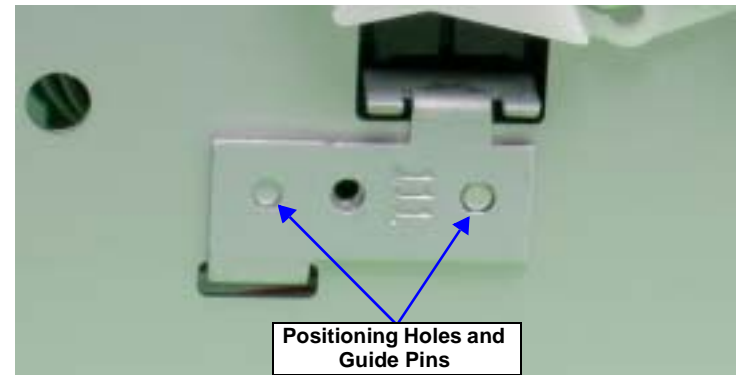

Figure 4-100. Installing the Support Frame (Right)

- Tighten the screws in the order shown in [Figure 4-99](#).

8. Remove the Ink System Unit downwards from the Main Frame keeping the Unit from coming in contact with the Paper EJ Transmission Lock Lever.

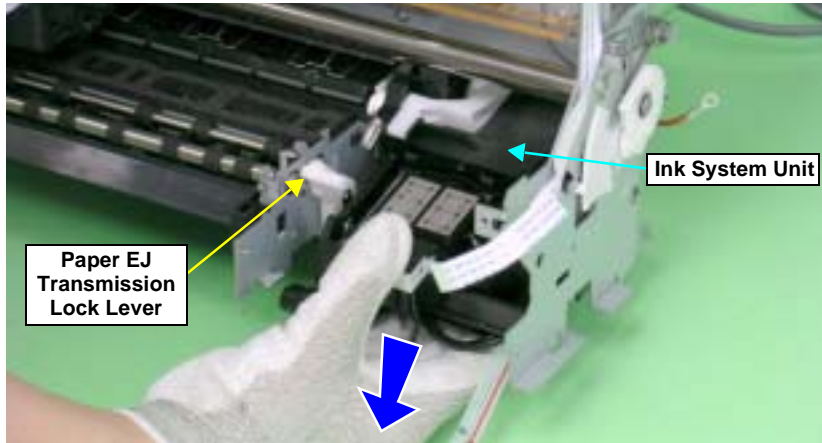

Figure 4-101. Removing the Ink System Unit



- When the Ink System Unit is removed from the Printer Mechanism, the Paper EJ Lock Release Cam may drop off. In such case, correctly install it referring to the figure below.



Figure 4-102. Installing the Paper EJ Lock Release Cam



- Place the Paper EJ Lock Release Cam on the rear side of the Paper EJ Transmission Lock Lever.

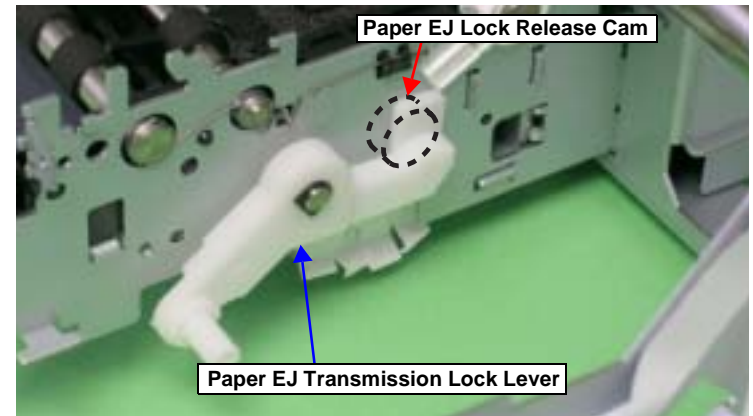

Figure 4-103. Reinstalling the Ink System Unit (1)

- Align the positioning hole on the Main Frame with the Guide Pin on the Ink System Unit.

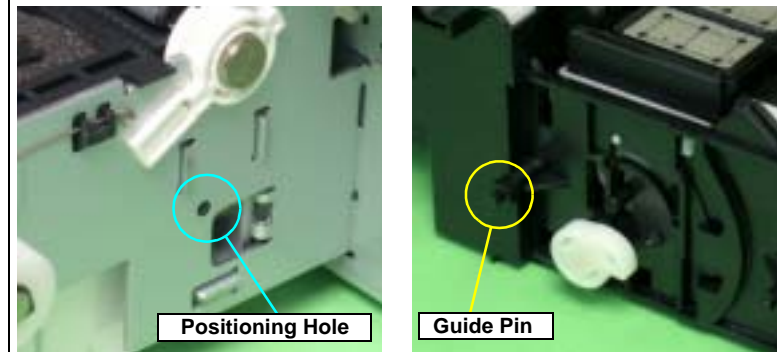

Figure 4-104. Reinstalling the Ink System Unit (2)



### 4.2.6.9 Release Holder Assy

1. Remove the ASF Assy. See Section 4.2.4 on page 83.
2. Release the PE Sensor Connector Cable from the five Tabs on the Release Holder Assy.
3. Remove the three C.B.S. M3 x 6 screws that secure the Release Holder Assy.
4. Remove the three lower Tabs of the Release Holder Assy from the Main Frame with a flat-blade screwdriver, and remove the Release Holder Assy upwards.

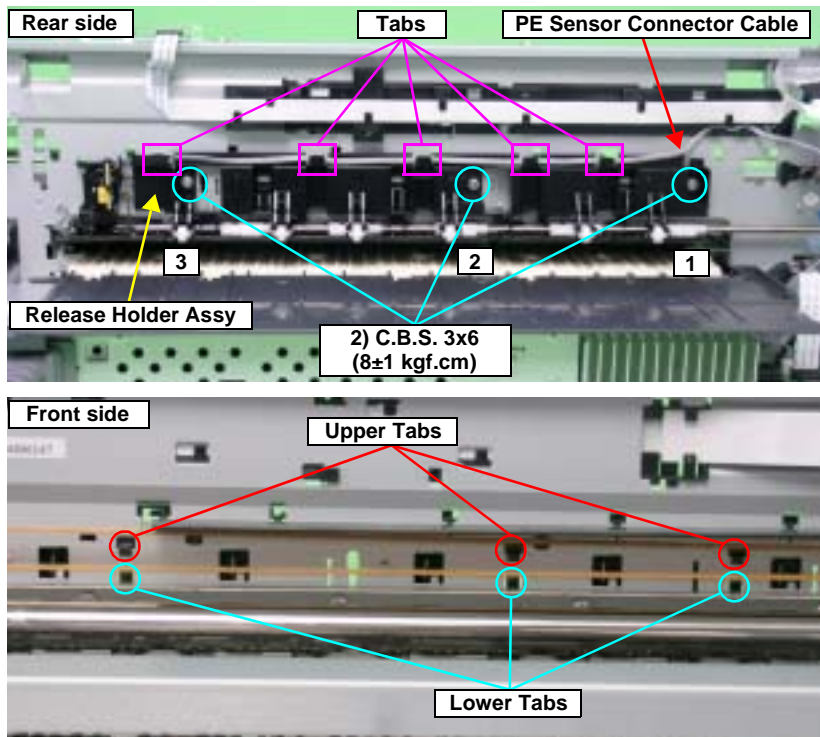

Figure 4-105. Removing the Release Holder Assy



- Align the three Upper Tabs on the Release Holder Assy with the positioning holes on the Main Frame. See Figure 4-105.
- Fit the FLAG Release Shaft by the Bushings on the Release Holder Assy.

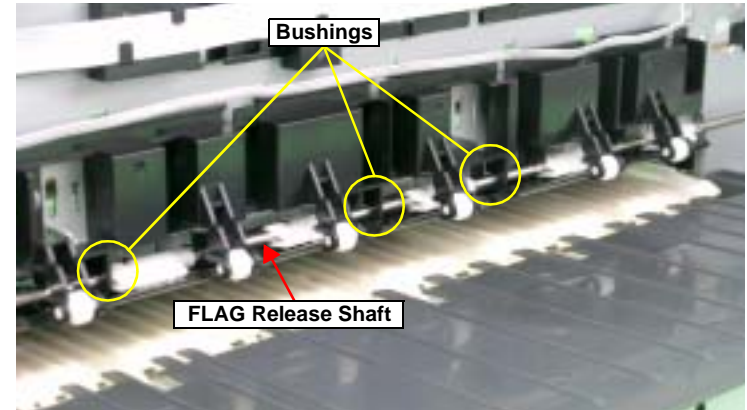

Figure 4-106. Reinstalling the Release Holder Assy

- Tighten the screws in the order shown in Figure 4-105.

#### 4.2.6.10 FLAG Release Assy.

1. Remove the APG Assy. See Section 4.2.6.3 on page 93.
2. Remove the Release Holder Assy. See Section 4.2.6.9 on page 112.
3. Remove the Guide Pin on the Driven Release Holder from the Main Frame using tweezers, and slide the Driven Release Holder to the left as viewed from the front of the Printer Mechanism.

**CAUTION**

In the following procedure, Parallel Pin 1.5 may drop off when the Driven Release Holder is slid. Be careful not to lose it.

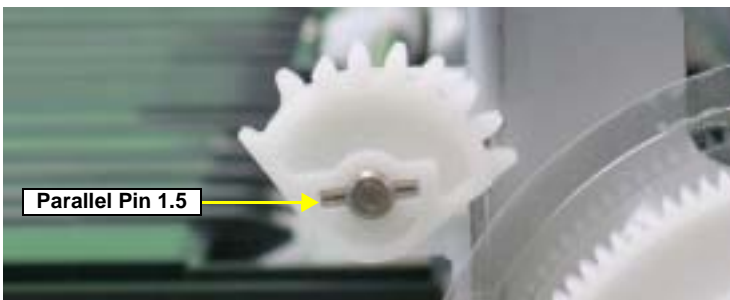

Figure 4-107. Parallel Pin 1.5

4. Release the three Tabs on the Driven Release Holder from the Main Frame, and remove the FLAG Release Assy.

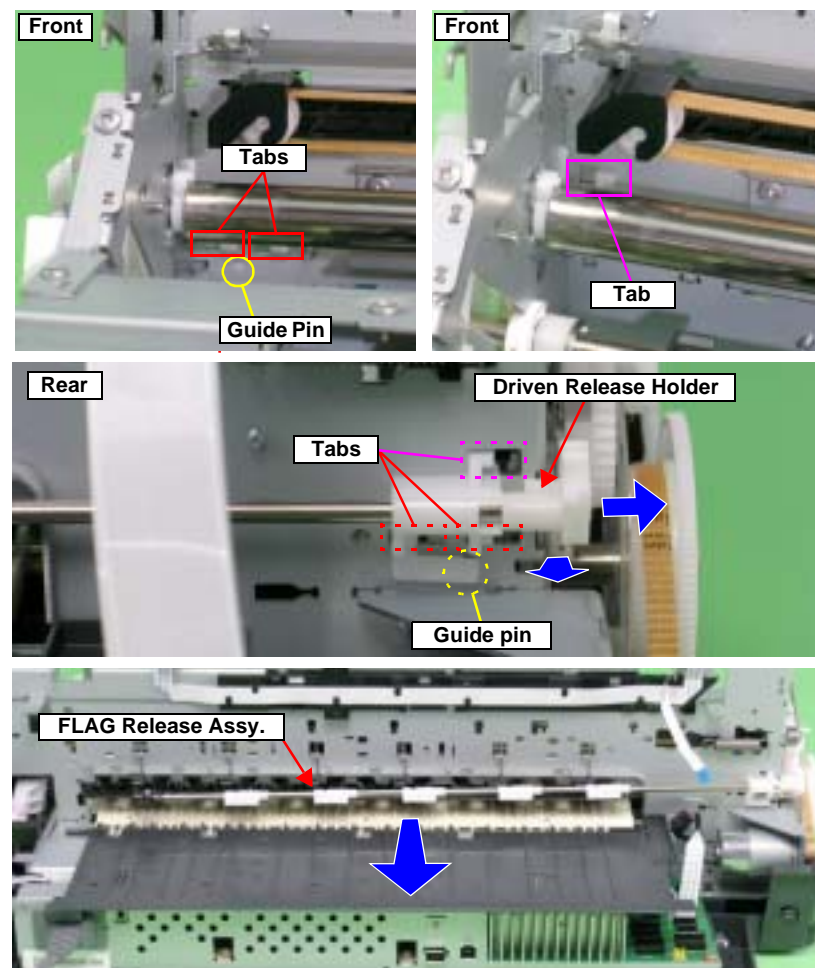

Figure 4-108. Removing the FLAG Release Assy

**REASSEMBLY**

Attach the five Perforated Sheets and the LD Cover Sheet to the six locations shown in the figure below to prevent ink from sticking to the LD Rollers.

- Remove the five Paper Guide Torsion Springs from the Tabs, insert the notches of the Perforated Sheets into the Tabs to attach them to the Main Frame, and then hook the Paper Guide Torsion Springs onto the Tabs again.
- Insert the LD Cover Sheet in between the frame so that the Tabs on the upper side of the LD Cover Sheet are visible from the notches on the Main Frame, and attach the LD Cover Sheet.

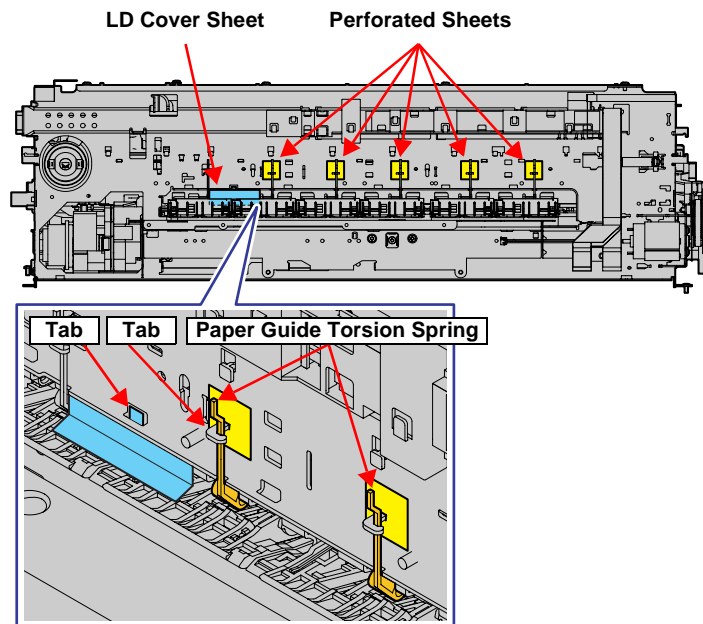

Figure 4-109. Attaching the Perforated Sheets and the LD Cover Sheet

#### 4.2.6.11 Upper Paper Guide Assys.

1. Remove the FLAG Release Assy. See Section 4.2.6.10 on page 113.
2. Remove the PE Sensor Holder. See Section 4.2.8.1 on page 124.
3. Pass a sheet of A3 size paper into the gap between the Upper Paper Guide Assy and the Rear Paper Guide.

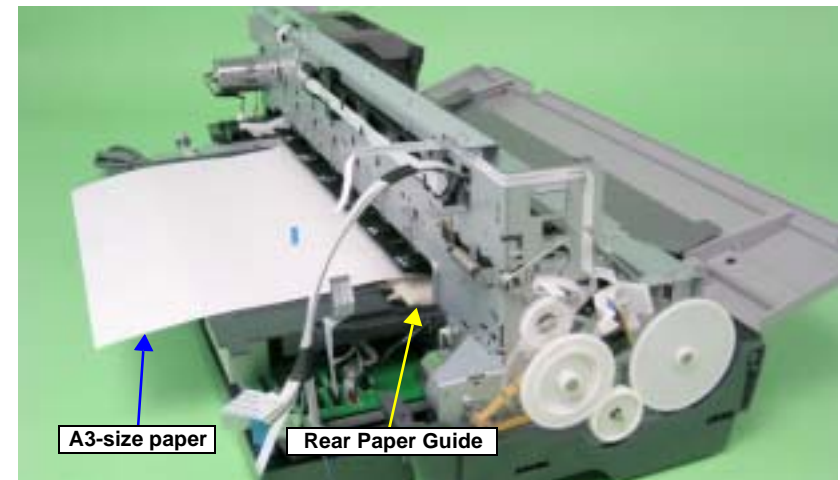

Figure 4-110. Setting the Paper

- Remove the six Upper Paper Guide Torsion Springs from the Tabs on the Main Frame, and draw out the Upper Paper Guide Torsion Springs from the six Upper Paper Guide Assys.

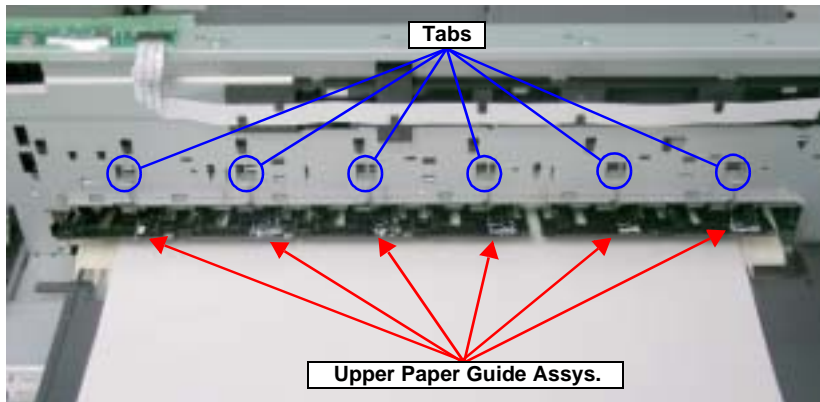
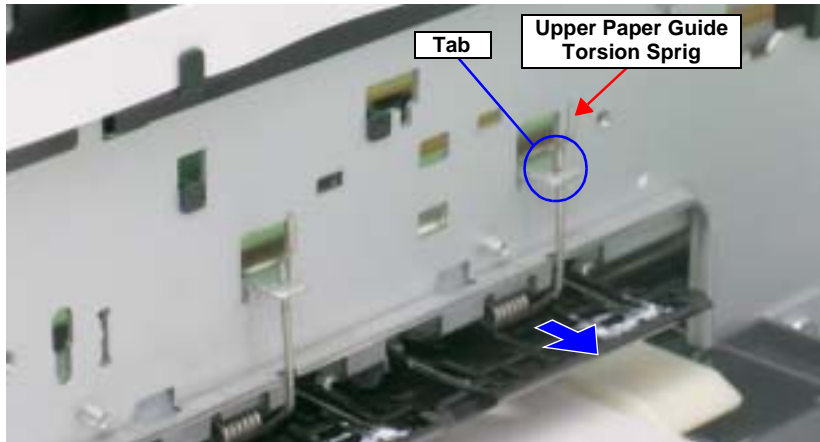

Figure 4-111. Removing the Upper Paper Guide Torsion Spring



Make sure that the leading end of the Upper Paper Guide Torsion Spring can be seen through the hole of the Upper Paper Guide Assy.

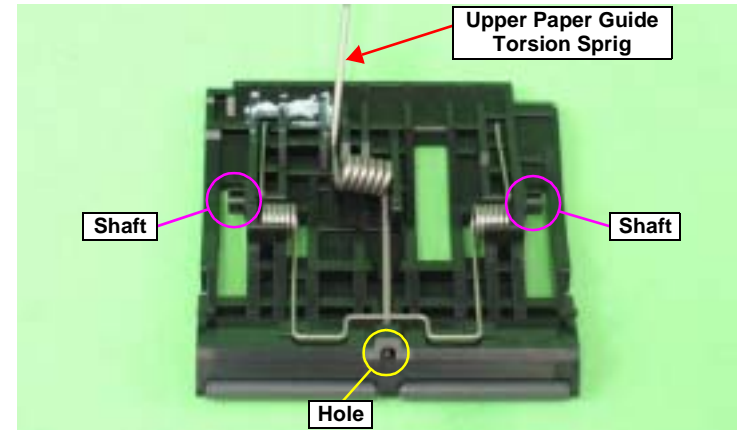

Figure 4-112. Reinstalling the Upper Paper Guide Torsion Spring

- Lift the six Upper Paper Guide Assys from the Main Frame to release the shaft referring to Figure 4-112., and remove the Upper Paper Guide Assys to the rear.

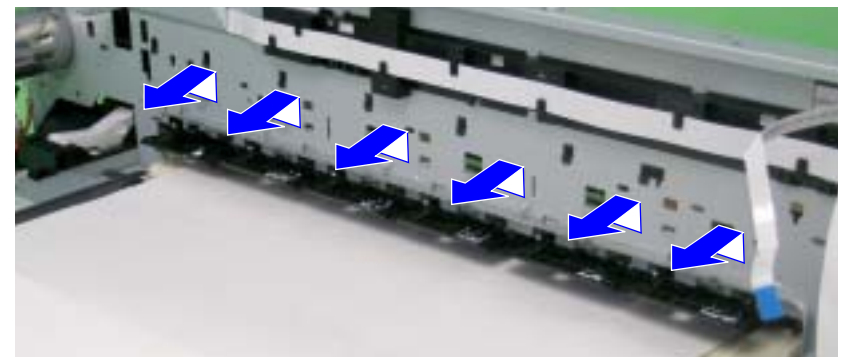

Figure 4-113. Removing the Upper Paper Guide Assy



ADJUSTMENT  
REQUIRED

After replacing the following part, be sure to apply G-26 grease to the specified area. See [Figure 6-9 on page 177](#).

- Upper Paper Guide Assy

#### 4.2.6.12 Front Paper Guide and Paper eject roller

1. Remove the Printer Mechanism. See [Section 4.2.1.5 on page 78](#).
2. Remove the Paper EJ Frame Assy. See [Section 4.2.6.6 on page 105](#).
3. Release the Carriage lock, and move the Carriage Unit to the center. See [Section 4.2.1.3 on page 75](#).
4. Remove the EJ Grounding Spring from the Main Frame with tweezers.



Figure 4-114. Removing the EJ Grounding Spring

REASSEMBLY



Referring to [Figure 4-115](#)., correctly install the EJ Grounding Spring.



Figure 4-115. Reinstalling the EJ Grounding Spring

5. Remove the Spacer from the EJ Roller Shaft.
6. Remove the Guide Pins on Left Bushing 8 from the Main Frame using tweezers, and turn Left Bushing 8 toward you to align with the notches on the Main Frame.

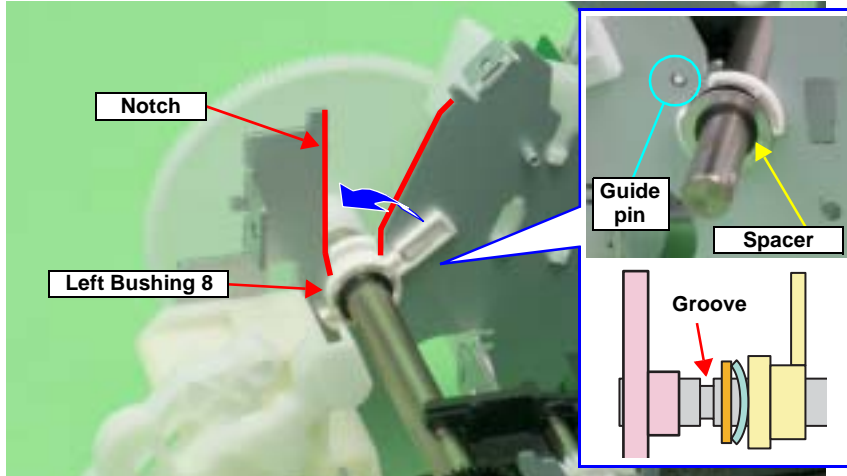

Figure 4-116. Removing the Spacer and Rotating the Left Bushing 8



Insert the Spacer into the groove on the Front Paper Eject Roller.

7. Slide the Front Paper Eject Roller to the left, and remove the Left Bushing 8 from the Main Frame.

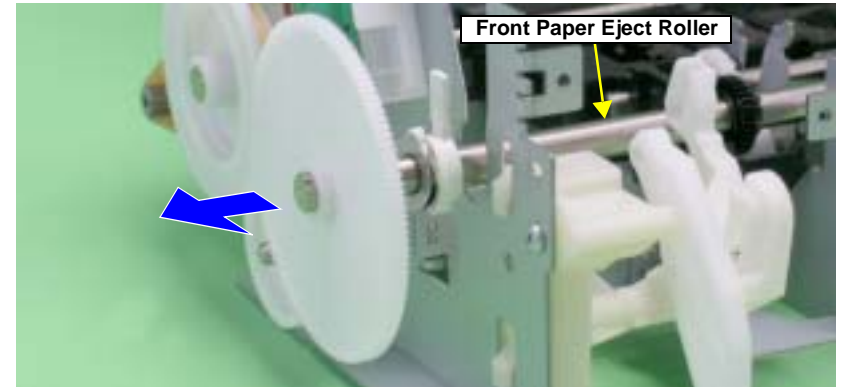

Figure 4-117. Removing the Left Bushing 8

8. Return the Carriage Unit to its home position.
9. Release the Tab that secures the Front Paper Guide from the Main Frame and slide the Front Paper Guide to the left, and turn it until the front side faces up to remove the Front Paper Guide together with the Paper Eject Roller.

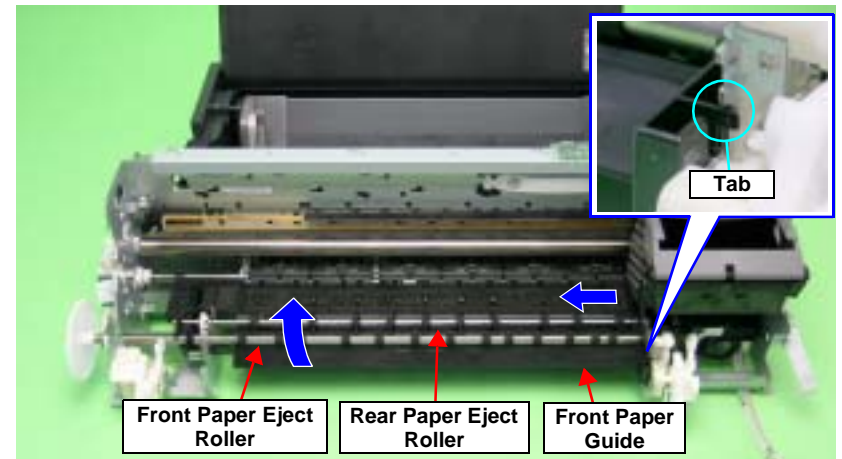

Figure 4-118. Removing the Front Paper Guide and Paper Eject Rollers



- Align the Bushing of the Front Paper Guide with the PF Roller Shaft.

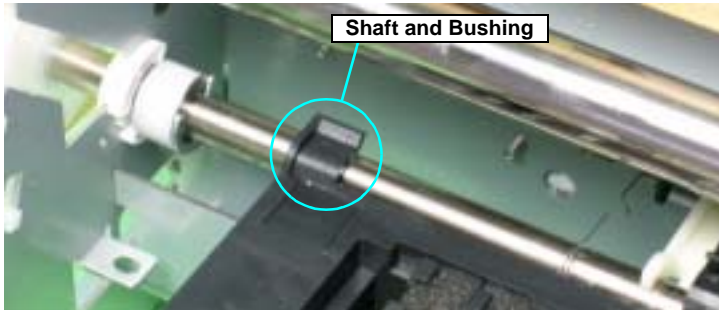

Figure 4-119. The PF Roller Shaft and the Bushing of the Front Paper Guide

- Align the positioning holes on the Main Frame with the Guide Pins on the Front Paper Guide.

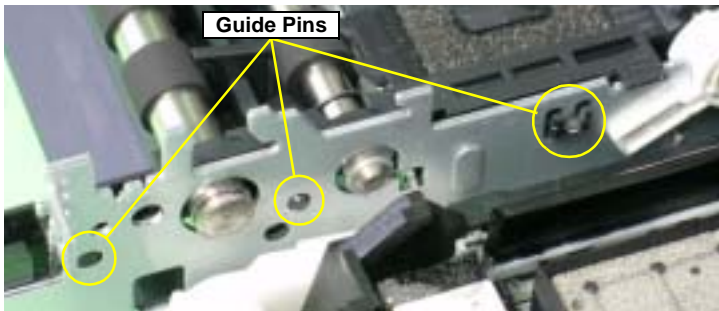

Figure 4-120. Reinstalling the Front Paper Guide



After installing the Front Paper Guide, lift the Printer Mechanism to check the following points.

1. Make sure that the Tabs on the Paper Guide Pad are not cut midway.
2. Make sure that all Tabs are facing down (toward the Waste Ink Pads) without any folds.
3. Make sure that the Tab foldbacks are protruding completely from the Front Paper Guide.

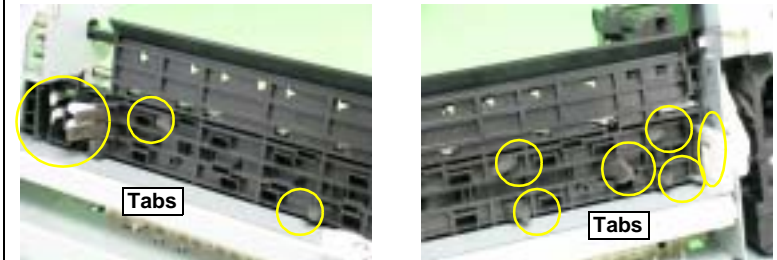

Figure 4-121. Checking the Front Paper Guide Pad



After replacing the following part, be sure to apply G-45 grease to the area specified for each part.

- EJ Grounding Spring [See Figure 6-10 on page 177.](#)
- Front Paper Guide and Paper Eject Roller [See Figure 6-11 on page 177.](#)



Be sure to perform the following adjustments after the Front Paper Guide and Paper eject roller are replaced or removed:

1. Ink Mark Sensor Adjustment
2. PW Sensor Adjustment
3. PF Adjustment
4. PF Adjustment (Bottom Margin)

Refer to Chapter 5 "Adjustment" for details of the adjustments.

### 4.2.6.13 PF Roller Shaft

1. Remove the Upper Paper Guide Assys. See Section 4.2.6.11 on page 114.
2. Remove the PF Encoder Sensor Holder. See Section 4.2.8.4 on page 126.
3. Remove the Front Paper Guide and Paper eject roller. See Section 4.2.6.12 on page 116.
4. Loosen the two C.C. M3 x 4 screws that secure the PF Motor, and remove the PF Drive Belt from the PF Motor Pinion Gear.
5. Remove the Spacer that secures Spur Gear 31.5, and remove Spur Gear 31.5 from the Printer Mechanism.

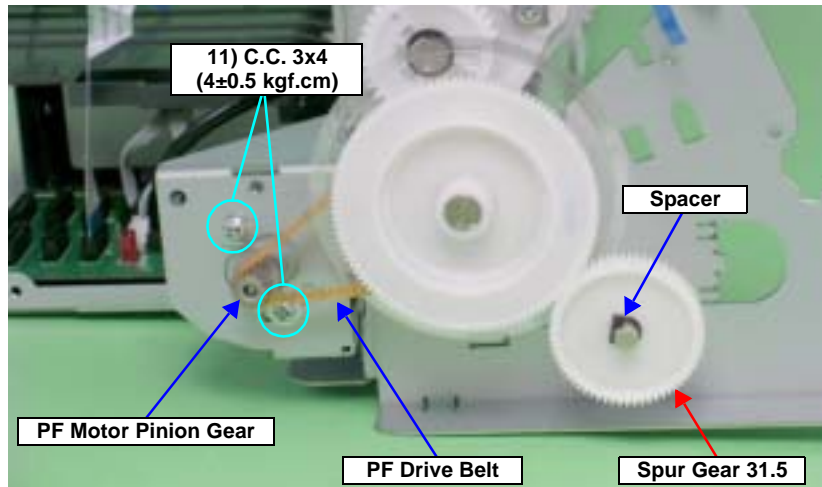

Figure 4-122. Removing the PF Drive Belt and Spur Gear 31.5

6. Remove the PG Grounding Spring from the notch on the Main Frame, and remove the PF Grounding Spring from the groove on the PF Roller Shaft.

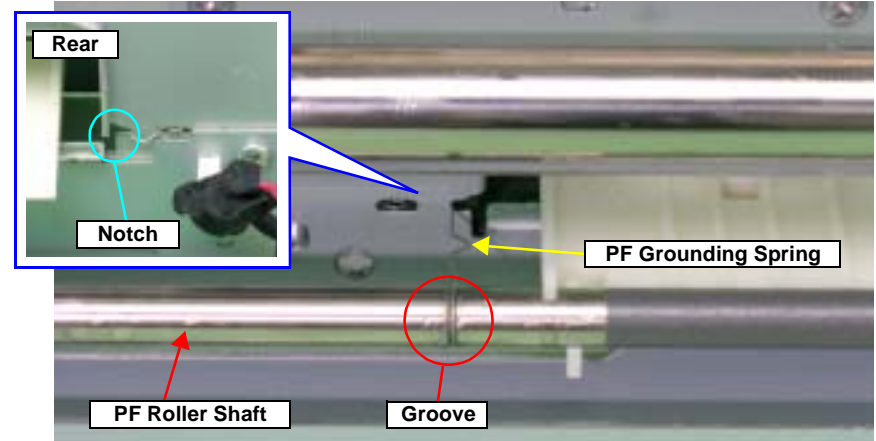

Figure 4-123. Removing the PF Grounding Spring

7. Make sure that the Left Parallelism Adjust Bushing is not protruding from the notch on the Main Frame. If it is protruding, loosen the C.B.S. (P4) M3 x 8 screw that secures the Left Parallelism Adjust Bushing, and slide it to prevent the Left Parallelism Adjust Bushing from becoming hooked on the notch.

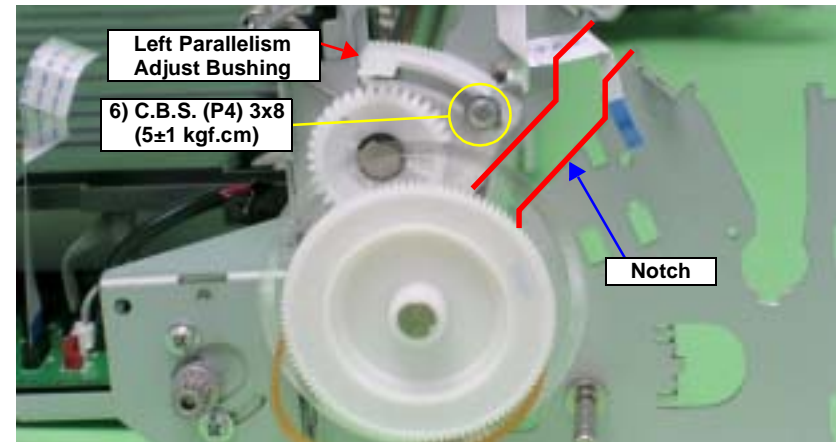

Figure 4-124. Rotating the Left Parallelism Adjust Bushing



- Remove the Guide Pin of Left Bushing 8 from the Main Frame using tweezers, and rotate the Bushing upwards to align with the notch on the Main Frame.

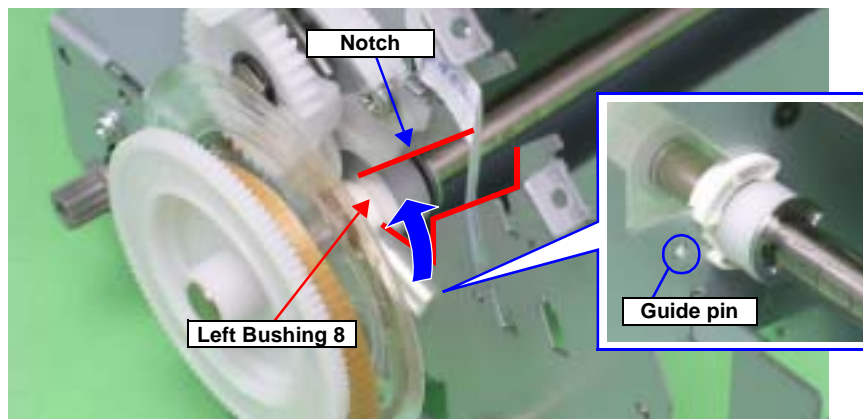

Figure 4-125. Rotating the Left Bushing 8



When performing the following procedure, pay attention to the following points.

- Prevent the coated surface of the PF Roller Shaft from being scratched.
- Do not touch the coated surface of the PF Roller Shaft with bare hands.

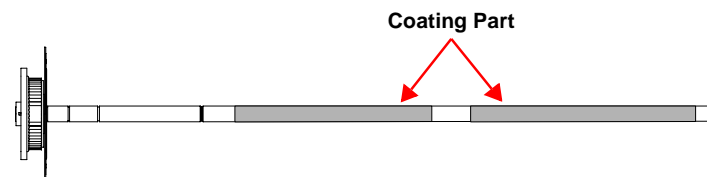

Figure 4-127. Handling the PF Roller Shaft



When performing the following procedure, take care not to lose the E-ring.

- Remove the E-ring from the PF Roller Shaft with a flat-blade screwdriver, and slide Left Bushing 8 to the inside of the Printer Mechanism.

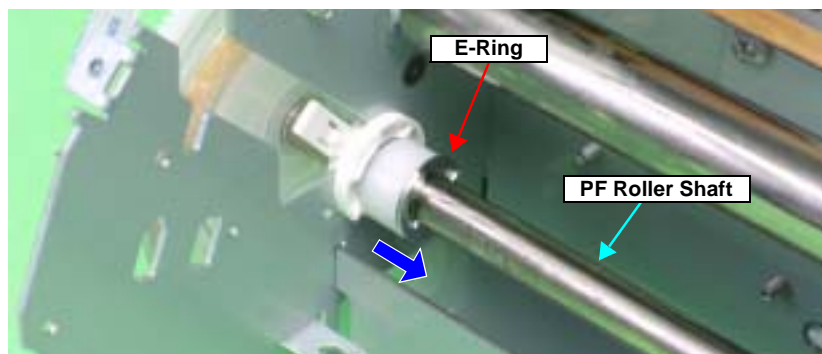

Figure 4-126. Removing the Left Bushing 8

10. Remove the PF Roller Shaft from the Bushings on the Rear Paper Guide and the Center Support, slide the PF Roller Shaft to the left to remove it from Right Bushing 8, and remove the PF Roller Shaft along the notch of the Main Frame.

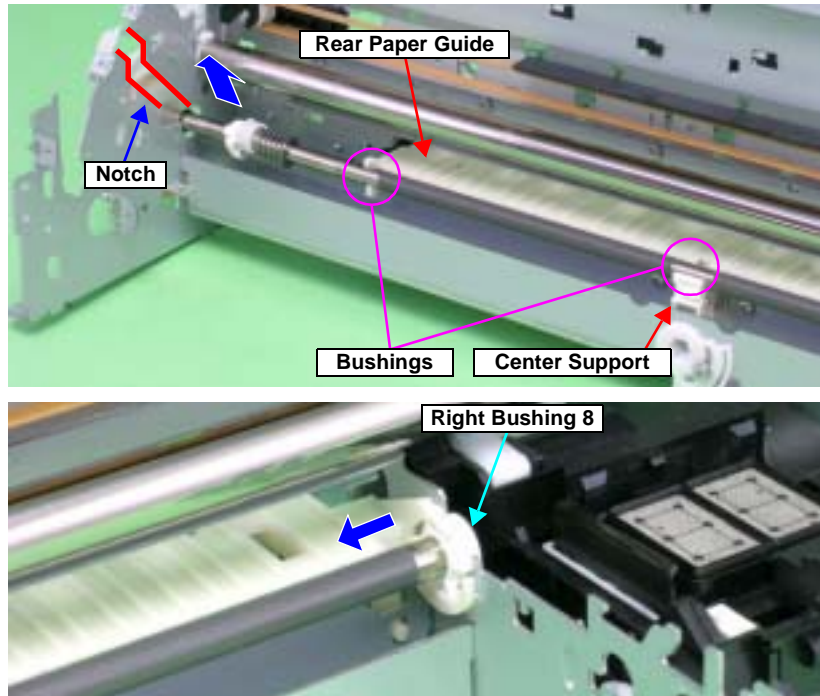

Figure 4-128. Removing the PF Roller Shaft

**CAUTION**



Be careful not to move Compression Spring 4 and the Leaf Spring on the left side of the PF Roller Shaft to the coated section on the Shaft after removing the PF Roller Shaft.

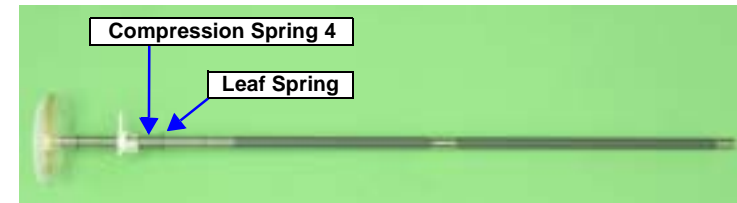

Figure 4-129. Handling the PF Roller Shaft

**ADJUSTMENT  
REQUIRED**



After replacing the following part, be sure to apply G-45 grease to the area specified for each part.

- PF Roller Shaft: See Figure 6-12 on page 177.
- Rear Paper Guide: See Figure 6-13 on page 178.
- PF Grounding Spring: See Figure 6-13 on page 178.

**ADJUSTMENT  
REQUIRED**



After replacing or removing the PF Roller Shaft, be sure to make the following adjustments.

1. PF Belt Tension Adjustment
2. PF Roller Shaft Center Support Position Adjustment
3. PG Adjustment (Only when moved the Left Parallelism Adjust Bushing)
4. Ink Mark Sensor Adjustment
5. PW Sensor Adjustment
6. PF Adjustment
7. PF Adjustment (Bottom Margin)

Refer to Chapter 5 "Adjustment" for details of the adjustments.

## 4.2.7 Removing the Motors

### 4.2.7.1 CR Motor

1. Remove the Upper Housing. See Section 4.2.1.4 on page 76.
2. Release the Carriage lock, and move the Carriage Unit to the center. See Section 4.2.1.3 on page 75.
3. Disconnect the CR Motor Connector Cable from the Relay Connector.

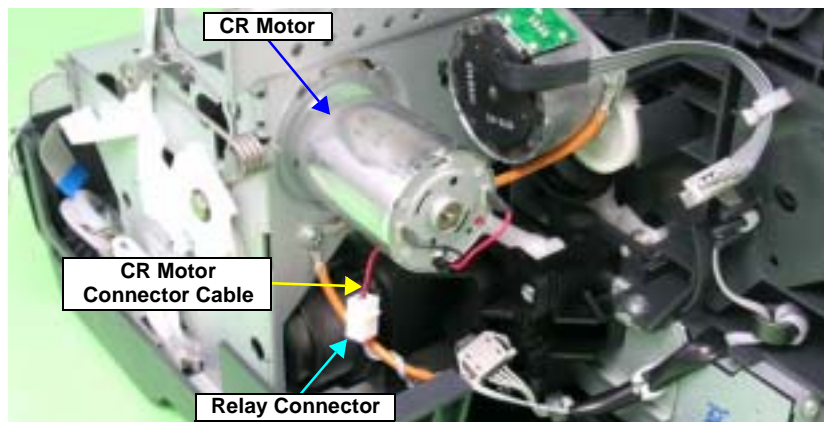
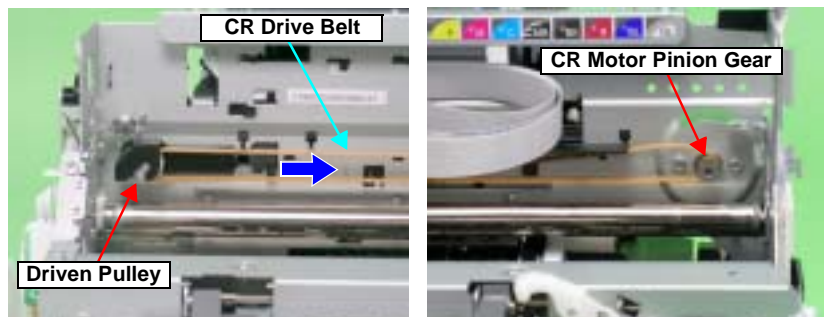

Figure 4-130. Removing the CR Motor Connector Cable

4. Press the Driven Pulley toward the center to loosen the CR Drive Belt, and remove the CR Drive Belt from the CR Motor Pinion Gear.



5. Remove the two C.B.S. M3 x 4 screws that secure the CR Motor, and remove the CR Motor from the Main Frame.

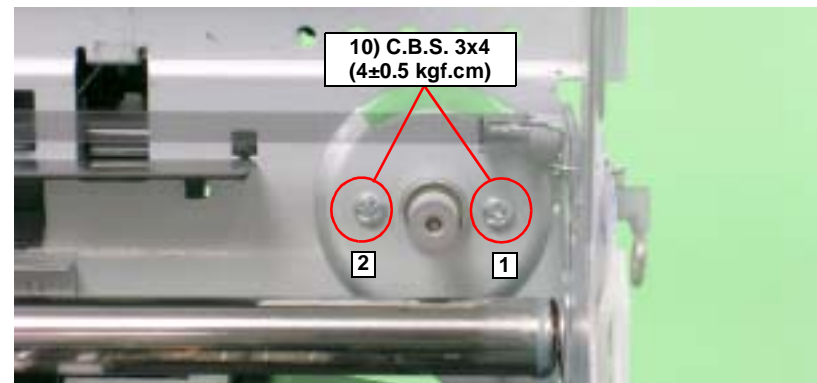

Figure 4-131. Removing the CR Motor



- Make the Lot No. printed surface on the CR Motor face the direction shown in the figure below.

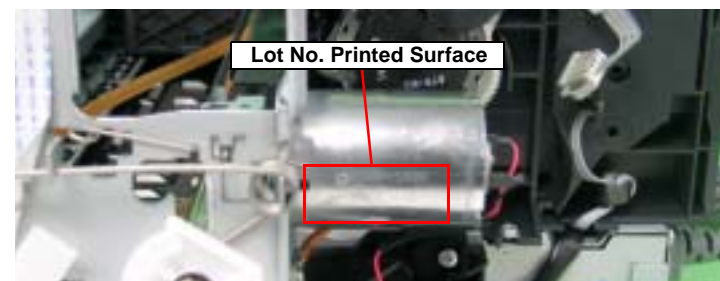

Figure 4-132. Reinstalling the CR Motor

- Tighten the screws in the order shown in Figure 4-131.



Be sure to perform the following adjustments after replacing the CR Motor.

- CR Motor Drive Dispersion  
Refer to Chapter 5 "Adjustment" for details of the adjustments.



### 4.2.7.2 PF Motor

1. Remove the Printer Mechanism. See Section 4.2.1.5 on page 78.
2. Disconnect the PF Motor Connector Cable from Connector CN16 (black) on the Main Board, and remove it from the Clamp on the Main Frame.
3. Remove the two C.C. M3 x 4 screws that secure the PF Motor.
4. Remove the PF Drive Belt from the PF Motor Pinion Gear, and remove the PF Motor from the Printer Mechanism.

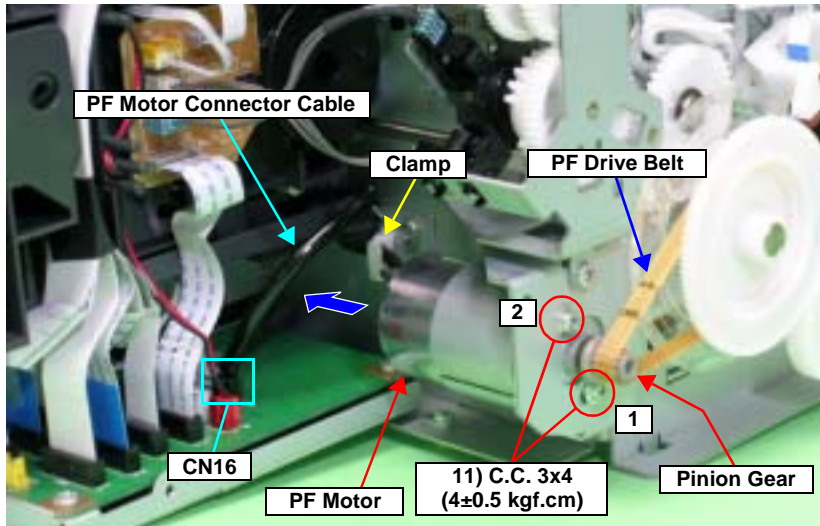

Figure 4-133. Removing the PF Motor



- Make the slit on the PF Motor face the direction shown in the figure below.

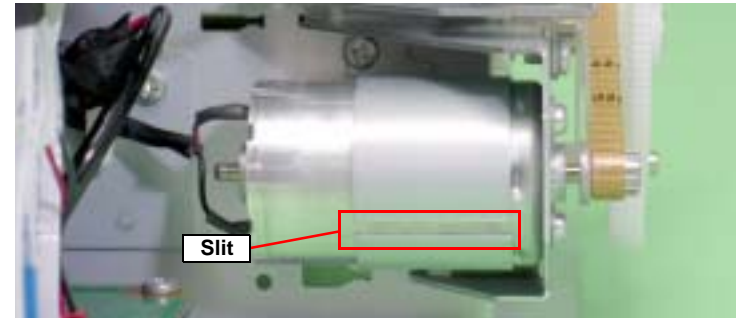

Figure 4-134. Reinstalling the PF Motor

- Tighten the screws in the order shown in Figure 4-133.



After replacing or removing the PF Motor, be sure to make the following adjustments.

1. PF Belt Tension Adjustment
2. PF Roller Shaft Center Support Position Adjustment
3. PF Adjustment
4. PF Adjustment (Bottom Margin)

Refer to Chapter 5 "Adjustment" for details of the adjustments.

## 4.2.8 Removing the Sensors

### 4.2.8.1 PE Sensor Holder

1. Remove the ASF Assy. See Section 4.2.4 on page 83.
2. Remove the PE Sensor Connector Cable from the five Tabs on the Release Holder Assy and the two Tabs on the Head Cable Cover.

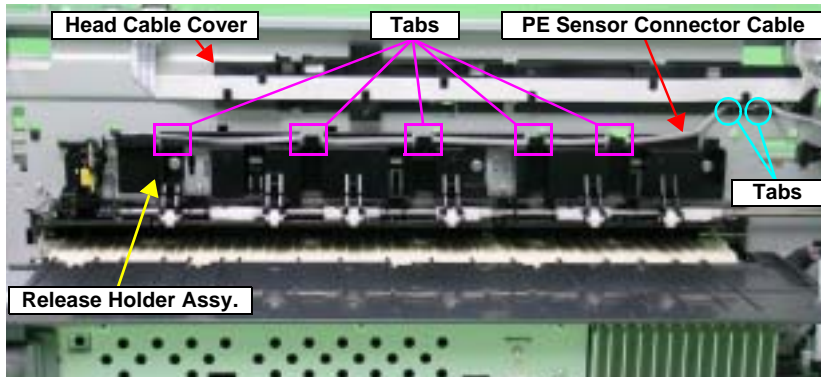

Figure 4-135. Releasing the Cables

3. Release the Tabs that secure the PE Sensor Holder from the notch on the Main Frame with a flat-blade screwdriver, and slide upwards and then remove toward you.

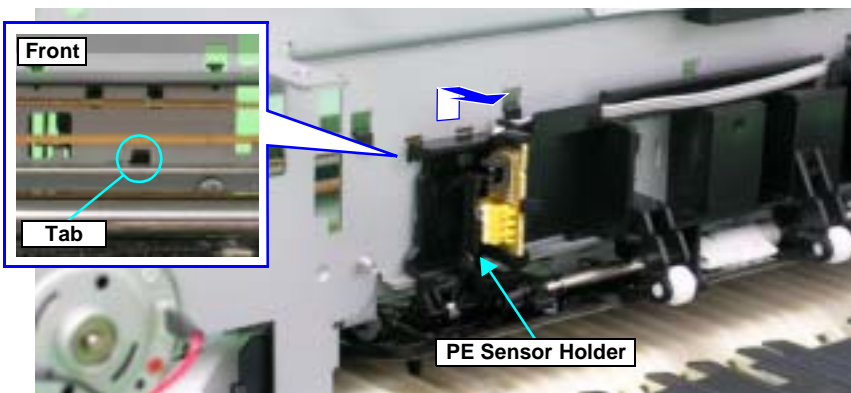

Figure 4-136. Removing the PE Sensor Holder



Align the four Tabs and Guide Pin on the PE Sensor Holder with the positioning holes on the Main Frame correctly so that there is no gap between the PE Sensor Holder and the Main Frame.

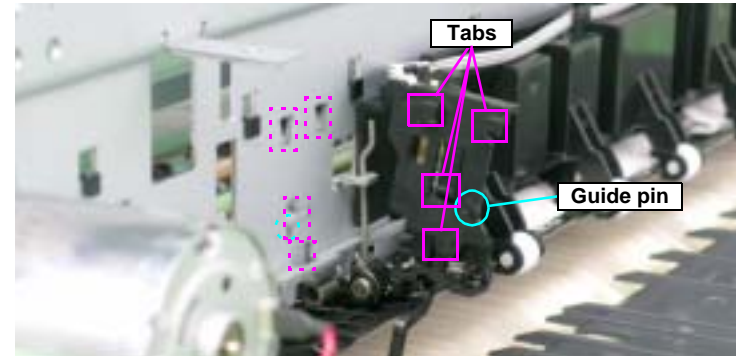

Figure 4-137. Reinstalling the PE Sensor

### 4.2.8.2 Ink Mark Sensor and PW sensor

1. Remove the Carriage Unit. See Section 4.2.6.4 on page 95.
2. Remove the C.P.B. (P1) M1.7 x 5 screw that secures the PW Sensor Holder, and remove the PW Sensor Holder from the Carriage Unit.

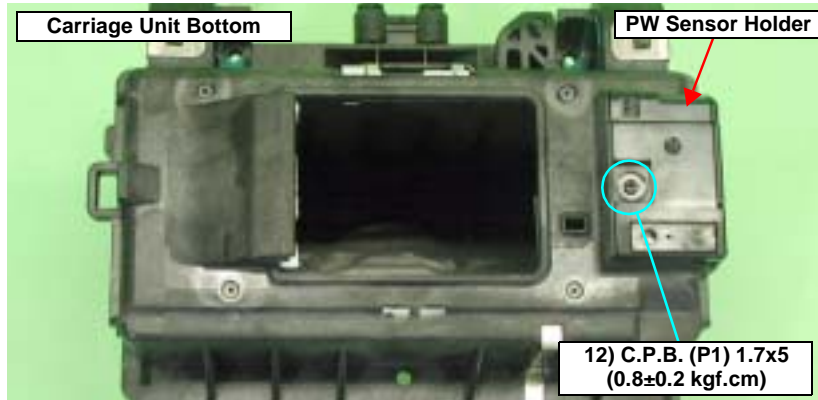

Figure 4-138. Removing the PW Sensor Holder

3. Disconnect the FFC from the Ink Mark Sensor and the PW Sensor Connector, and remove the Ink Mark Sensor and PW Sensor.

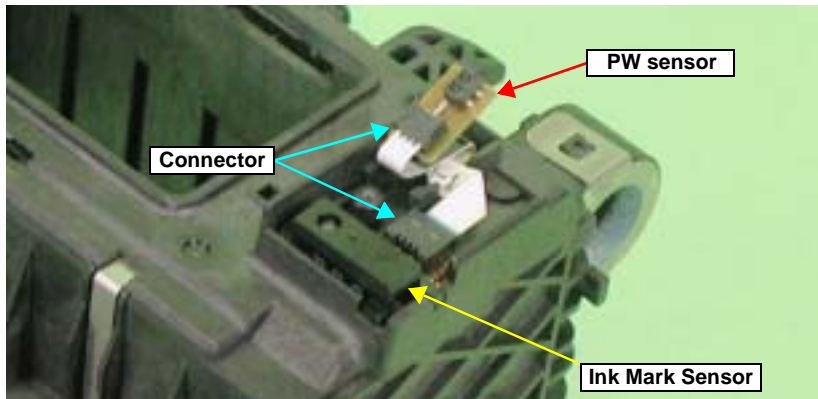

Figure 4-139. Removing the Ink Mark Sensor and PW Sensor



Make sure that the FFC is routed as shown in [Figure 4-139.](#)



After replacing or removing the Ink Mark Sensor and the PW Sensor, be sure to make the following adjustments.

- Ink Mark Sensor
  1. Ink Mark Sensor Adjustment
  2. Ink Mark Sensor Check
  3. PW Sensor Adjustment
- PW Sensor
  1. Ink Mark Sensor Adjustment
  2. PW Sensor Adjustment

Refer to Chapter 5 "Adjustment" for details of the adjustments.

#### 4.2.8.3 CR Encoder Sensor Board

1. Remove the Carriage Unit. [See Section 4.2.6.4 on page 95.](#)
2. Remove the two C.B.P. M2.6 x 5 screws that secure the CR Encoder Sensor Board.
3. Disconnect the FFC of PW Sensor and Ink Mark Sensor from the Connector on the CR Encoder Sensor Board, and remove the CR Encoder Sensor Board.

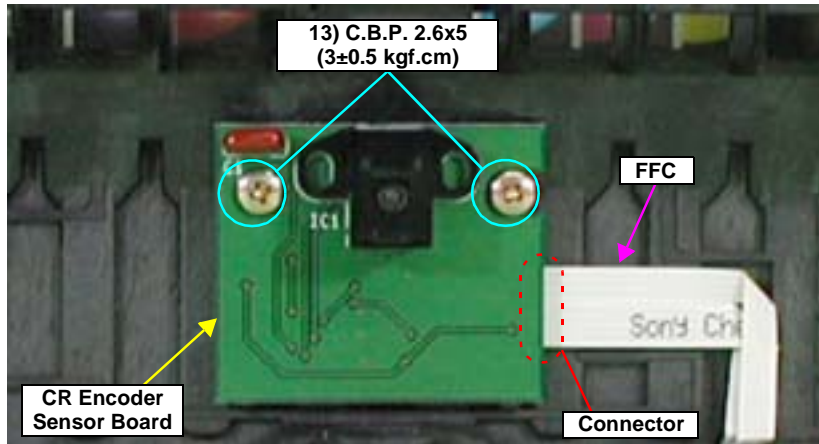

Figure 4-140. Removing CR Encoder Sensor Board

#### 4.2.8.4 PF Encoder Sensor Holder

1. Remove the Upper Housing. [See Section 4.2.1.4 on page 76.](#)
2. Disconnect the FFC from the PF Encoder Sensor Board.
3. Remove the C.B.S. M3 x 8 screw that secures the PF Encoder Sensor Holder.

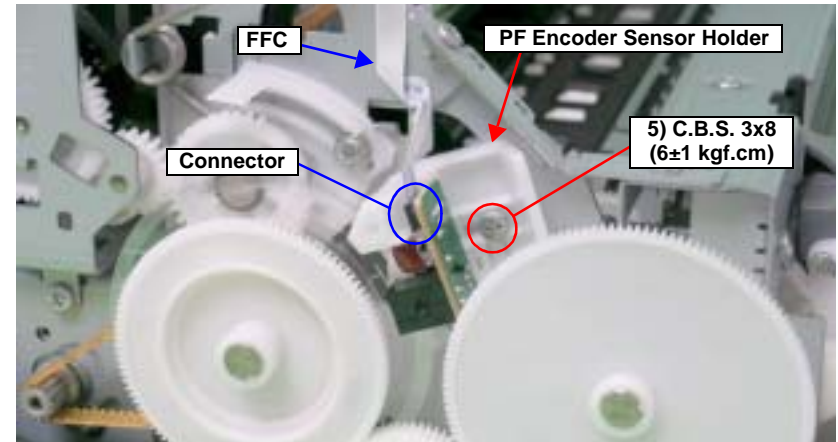

Figure 4-141. Removing the FFC and the Screw that Secures the PF Encoder Sensor Holder



4. While pressing the Guide Pin on the PF Encoder Sensor Holder using tweezers, slide the Holder upwards to release the three Tabs, and remove the PF Encoder Sensor Holder.

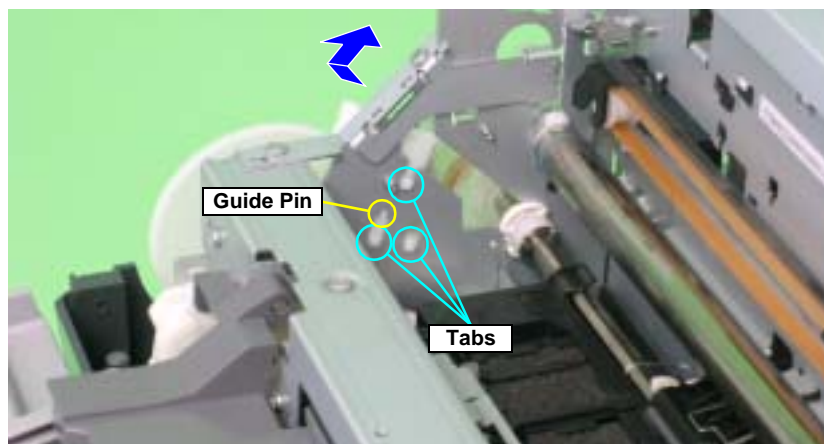

Figure 4-142. Removing the PF Encoder Sensor Holder



Make sure that the PF Scale is in the slit on the PF Encoder Sensor.

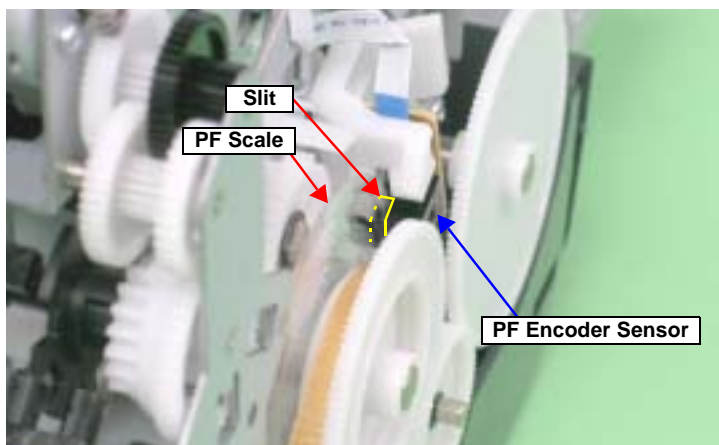

Figure 4-143. Reinstalling the PF Encoder Sensor Holder

CHAPTER

5

# ADJUSTMENT

## 5.1 Adjustment Items and Overview

This chapter describes adjustments to be made after the disassembly/reassembly of this product.

### 5.1.1 Servicing Adjustment Item List

The items, purposes and outlines of the Adjustment Program are given in the following table.

**Table 5-1. Adjustment Items**

Adjustment	Purpose	Method Outline
PF Belt Tension Adjustment	This adjustment is made to reduce the load on the PF motor and to ensure paper feed accuracy.	<a href="#">See Section 5.2.1 on page 137.</a>
PF Roller Shaft Center Support Position Adjustment	This adjustment is made to compensate the deflection amount on the PF Roller Shaft and to maintain the appropriate paper feed amount.	<a href="#">See Section 5.2.3 on page 143.</a>
PG Adjustment	This adjustment is made to ensure the correct distance between the head surface and the Front Paper Guide, and to adjust the parallelism between the 0 digit side and the 130 digit side to ensure consistent print quality.	<a href="#">See Section 5.2.2 on page 139.</a>
Main Board Data Read/Write Function	The purpose of this function is to read required information from EEPROM on a defective Main Board using the D4 function and to reduce the number of ancillary adjustment items when the board is replaced.	<ol style="list-style-type: none"> <li>1. Select this function in the Adjustment Program.</li> <li>2. Read data from the defective Main Board.</li> <li>3. After replacing the Main Board, write the data to the new board.</li> </ol>
Market & Initial Settings	After replacing the Main Board, information common to Main Boards is written by market setting.	<ol style="list-style-type: none"> <li>1. Select and execute this function in the Adjustment Program.</li> <li>2. Write the market-by-market settings and initial settings to the EEPROM. <ul style="list-style-type: none"> <li>■ Market-by-market settings</li> <li>■ Market ID</li> <li>■ CSIC Printer ID</li> </ul> </li> </ol>
USB ID Input	A USB ID is given to each printer to identify a specific printer when using multiple printers of same model.	<ol style="list-style-type: none"> <li>1. Select this function in the Adjustment Program and enter the serial number of the printer.</li> <li>2. The correction value is saved to the specific EEPROM address of the Main Board.</li> </ol>
IEEE1394 ID Input	When multiple printers of the same model are connected to the PC in a daisy chain, etc., this adjustment is made to allow the PC to recognize the connected printers individually.	<ol style="list-style-type: none"> <li>1. Read the 10-digit unique ID from the label applied to the rear of the Board Unit.</li> <li>2. Enter the ID in the Adjustment Program to store it in the EEPROM.</li> </ol>



Table 5-1. Adjustment Items

Adjustment	Purpose	Method Outline
Head ID Input	When replacing the Print Head, this adjustment is made to reduce head manufacturing variations, which may cause individual differences in print quality.	<ol style="list-style-type: none"> <li>1. Enter the ID of the Head QR Code Label (31 digits), which is applied to the Print Head, into the program.</li> <li>2. The ID is stored in the EEPROM of the Main Board. Supplement: Read the QR code label from left to right on the top row and from top to bottom in due order.)</li> </ol>
Head Angular Adjustment	This adjustment is made to correct the error in the Print Head mounting position (Head angle) to make the nozzle line straight with respect to the paper feeding direction. Angular displacement is also checked for.	<ol style="list-style-type: none"> <li>1. Select this function in the Adjustment Program and print the adjustment pattern.</li> <li>2. After checking the displacement amount of the pattern, enter the pattern number which has the smallest amount of displacement.</li> </ol>
Multi Sensor Adjustment(Ink Mark Sensor Adjustment)	This adjustment is made to correct a detection position error, which is caused by the displacement of the Ink Mark Sensor mounting position, on a software basis.	<ol style="list-style-type: none"> <li>1. Select and execute this function in the Adjustment Program.</li> <li>2. Pattern printing and adjustment are automatically executed.</li> </ol> Supplement: Be sure to confirm that there are no dots missing before executing this adjustment.
Auto Bi-D Adjustment	This adjustment is made to correct the print timing in the go and return paths in bi-directional printing.	<ol style="list-style-type: none"> <li>1. Select and execute this function in the Adjustment Program.</li> <li>2. Pattern printing and adjustment are automatically executed.</li> </ol> Supplement: Be sure to confirm that there are no dots missing before executing this adjustment.
Ink Mark Sensor Adjustment	This check is made to test whether the Ink Mark Sensor can detect patterns properly.	<ol style="list-style-type: none"> <li>1. Print a pattern with no dots missing, and check it with the Sensor.</li> <li>2. Print a pattern with five dots missing, and check it with the Sensor.</li> <li>3. The check result is OK if the two patterns are detected correctly. Be sure to confirm that there are no dots missing before executing this adjustment.</li> </ol>
First dot position	This function adjusts the print starting position in the CR main scanning direction.	<ol style="list-style-type: none"> <li>1. Select this function in the Adjustment Program and print the adjustment pattern.</li> <li>2. Select a pattern number 5mm away from each edge, and enter that number in the program.</li> <li>3. The correction value is saved to the specific EEPROM address of the Main Board.</li> </ol>
PW Sensor Adjustment	This adjustment is made to correct the PW Sensor mounting position on a software basis to improve a paper detection error caused by the variation of the mounting position.	<ol style="list-style-type: none"> <li>1. Select this function in the Adjustment Program and print the adjustment pattern.</li> <li>2. Select a pattern number 5mm away from each edge, and enter that number in the program.</li> <li>3. The correction value is saved to the specific EEPROM address of the Main Board.</li> </ol>
PF Deterioration Compensation Counter Reset	The deterioration amount of the PF Roller Shaft is reflected to the paper feed correction amount. Every time a sheet of paper is fed, the deterioration amount is counted on the basis of the original counter value setting. When the PF Roller Shaft or Printer Mechanism has been replaced during repair, the PF deterioration counter must be reset.	<ol style="list-style-type: none"> <li>1. Select and execute this function in the Adjustment Program.</li> <li>2. Reset the PF deterioration counter.</li> </ol>

Table 5-1. Adjustment Items

Adjustment	Purpose	Method Outline
Reset the PF deterioration counter (write the maximum value)	The PF deterioration compensation counter can be reset only when the PF Roller Shaft is new. To reduce the ancillary work in servicing, enter the maximum value (value for which deterioration compensation is not made) if the PF Roller Shaft has not been replaced.	<ol style="list-style-type: none"> <li>1. Select and execute this function in the Adjustment Program.</li> <li>2. Reset the PF deterioration counter.</li> </ol>
PF Adjustment	This correction is made when the actual paper feed amount differs greatly from the theoretical value due to paper slip, PF roller tolerances, etc. during paper feed for printing.	<ol style="list-style-type: none"> <li>1. Select this function in the Adjustment Program and print the adjustment pattern.</li> <li>2. Select or measure the adjustment value, and write it to the specific EEPROM address on the Main Board.</li> </ol>
PF Adjustment (Bottom Margin)	This correction is made when the actual paper feed amount while printing on the bottom of paper differs greatly from the theoretical value due to paper slip, exit roller tolerances, etc.	<ol style="list-style-type: none"> <li>1. Select this function in the Adjustment Program and print the adjustment pattern.</li> <li>2. Select or measure the adjustment value, and write it to the specific EEPROM address on the Main Board.</li> </ol>
Colorimetric Calibration	This adjustment is made to adjust the ink discharge amount.	<a href="#">See Section 5.2.4 on page 147.</a>
CR Motor Drive Dispersion	This adjustment is made to measure the manufacturing variations of the CR Motor and PS Board to make the most of the motor capabilities for motor heat generation control.	<ol style="list-style-type: none"> <li>1. Select/execute this function in the Adjustment Program.</li> <li>2. After execution, the variations are automatically measured and the measurement values are written to the EEPROM on the Main Board.</li> </ol>
CR Motor Drive Dispersion (Maximum value)	CR Dispersion Measurement can be performed only when the Carriage Shaft is new. To reduce the ancillary work in servicing, enter the worst value (on which heat generation limit is easily imposed) if the Carriage Shaft has not been replaced.	<ol style="list-style-type: none"> <li>1. Select/execute this function in the Adjustment Program.</li> <li>2. After execution, the dispersions are automatically measured and the worst value is written to the EEPROM on the Main Board.</li> </ol>

Table 5-2. Maintenance Functions

Function Item	Purpose	Method Outline
Ink Charge	This function is used for Print Head replacement to drain Shipping Liquid of the after-sales service part in the head flow path and simultaneously fill ink in the head flow path to make all nozzles printable and stabilize the ink in the Print Head.	<ol style="list-style-type: none"> <li>1. Select this function in the Adjustment Program.</li> <li>2. Transfer the factory-set command (CL execution command (Initial Ink Charge) is used as the command) to the printer to make the printer perform Initial Ink Charge operation.</li> </ol>
Refurbishment Function(Shipping Liquid replacement)	This function is used to refurbish the initially returned product. Specifically, clean the inside of the Head, and charge and replace the Shipping Liquid.	<ol style="list-style-type: none"> <li>1. Select this function in the Adjustment Program.</li> </ol>
Cleaning	This function is used to execute cleaning 3 (CL3) when ink is not delivered from the Print Head properly, e.g. dot missing or skewed injection.	<ol style="list-style-type: none"> <li>1. Select this function in the Adjustment Program.</li> <li>2. Execute CL3.</li> </ol>
Waste Ink Counter Reset	This function is used to read and reset the Waste Ink Counters.	<ol style="list-style-type: none"> <li>1. In the Adjustment Program, select data read or reset from this function. Before executing this function, replace the Waste Ink Pads on both the 0 digit and 130 digit side.</li> </ol>

## 5.1.2 Replacement Part-Based Adjustment Priorities

The following table indicates the replacement part-based adjustment item and priority list.

Note : Symbol explanation

- ⊙ After removing or replacing the part
- After replacing the part

**NOTE:** *The replacement part adjustment item indicates the adjustment to be made when the corresponding replacement part is removed singly, and does not include adjustment accompanied by ancillary work.*

Table 5-3. Replacement Part-Based Adjustment Item and Priority List (1)

Adjustment Item	Priority	Print Head	Main Board <sup>1</sup>	Main Board <sup>2</sup>	PS Board	Waste Ink Pads	Ink Mark Sensor	PW Sensor	CR Motor
PF Belt Tension Adjustment	1	–	–	–	–	–	–	–	–
PF Roller Shaft Center Support Position Adjustment	2	–	–	–	–	–	–	–	–
PG Adjustment	3	⊙	–	–	–	–	–	–	–
Main Board Data Read/Write Function	4	–	○	–	–	–	–	–	–
Initial Value Write	5	–	–	○	–	–	–	–	–
USB ID Input	6	–	–	○	–	–	–	–	–
IEEE-1394 ID Input	7	–	–	○	–	–	–	–	–
Head ID Input	8	○	–	○	–	–	–	–	–
Ink Mark Sensor Adjustment	9 <sup>3</sup>	⊙	–	○	–	–	⊙	⊙	–
Head Angular Adjustment	10	⊙	–	○	–	–	–	–	–
Auto Bi-D Adjustment	11 <sup>3</sup>	⊙	–	○	–	–	–	–	–
Ink Mark Sensor CHECK	12 <sup>3</sup>	–	–	○	–	–	⊙	–	–
First dot position	13	⊙	–	○	–	–	–	–	–
PW Sensor Adjustment	14	⊙	–	○	–	–	⊙	⊙	–
PF Deterioration Compensation Counter Reset	15	–	–	–	–	–	–	–	–
PF Deterioration Compensation Counter Reset (write the maximum value) <sup>4</sup>	16	–	–	○	–	–	–	–	–
PF Adjustment	17	–	–	○	–	–	–	–	–
PF Adjustment (Bottom Margin)	18	–	–	○	–	–	–	–	–
Colorimetric Calibration	19	○	○	○	○	–	–	–	–
Waste Ink Counter Reset	20	–	–	–	–	○	–	–	–
CR Motor Drive Dispersion	21	–	–	○	○	–	–	–	○

Note 1 : When data can be read from the old board.

2 : When data cannot be read from the old board.

3 : Nozzle check patterns must be printed for confirmation.

4 : Perform this adjustment when replacing the mechanical unit with a rebuilt one whose PF Roller is not new.

Note : Symbol explanation

⊙ After removing or replacing the part

○ After replacing the part

Table 5-4. Replacement Part-Based Adjustment Item and Priority List (2)

Adjustment Item	Priority	Carriage Shaft	Carriage Unit	PF Motor	Paper EJ Frame Assy.	PF Roller Shaft	Front Paper Guide/Paper Eject Roller	ASP Mechanism Unit	ASF Assy
PF Belt Tension Adjustment	1	–	–	⊙	–	⊙	–	–	–
PF Roller Shaft Center Support Position Adjustment	2	–	–	⊙	–	⊙	–	–	–
PG Adjustment	3	⊙	⊙	–	–	⊙ <sup>5</sup>	–	○	–
Reading and Writing Main Board Data	4	–	–	–	–	–	–	–	–
Initial Value Write	5	–	–	–	–	–	–	–	–
USB ID Input	6	–	–	–	–	–	–	–	–
IEEE-1394 ID Input	7	–	–	–	–	–	–	–	–
Head ID Input	8	–	–	–	–	–	–	–	–
Ink Mark Sensor Adjustment	9 <sup>3</sup>	○	○	–	⊙	⊙	⊙	○	–
Head Angular Adjustment	10	○	○	–	–	–	–	○	–
Auto Bi-D Adjustment	11 <sup>3</sup>	○	○	–	–	–	–	○	–
Ink Mark Sensor CHECK	12 <sup>3</sup>	–	–	–	–	–	–	○	–
First dot position	13	○	○	–	–	–	–	○	⊙
PW Sensor Adjustment	14	○	○	–	⊙	⊙	⊙	○	–
PF Deterioration Compensation Counter Reset	15	–	–	–	–	–	–	○	–
PF Deterioration Compensation Counter Reset (write the maximum value) <sup>4</sup>	16	–	–	–	–	–	–	–	–
PF Adjustment	17	–	–	⊙	⊙	⊙	⊙	○	–
PF Adjustment (Bottom Margin)	18	–	–	⊙	⊙	⊙	⊙	○	–
Colorimetric Calibration	19	–	–	–	–	–	–	–	–
Waste Ink Counter Reset	20	–	–	–	–	–	–	–	–
CR Motor Drive Dispersion	21	–	–	–	–	–	–	○	–

Note 1 : When data can be read from the old board.

2 : When data cannot be read from the old board.

3 : Nozzle check patterns must be printed for confirmation.

4 : Perform this adjustment when replacing the mechanical unit with a rebuilt one whose PF Roller is not new.

5 : This adjustment is required only when the Left Parallelism Adjust Bushing is moved.



### 5.1.3 Required Adjustment Tools

The following table lists the adjustment tools required for adjustment of this product.

**Table 5-5. List of Tools**

No.	Name	Part Code	Category	Overview
1	Adjustment Program	-	Software	This adjustment program is designed to display the required adjustment items in the appropriate order when a replacement part is selected, and provides workers with the accurate adjustment order.
2	G-26	1080614	Grease	For the Parallelism Adjust Bushing, Lower Paper Guide, Driven Release Shaft, etc.
3	G-45	1033657	Grease	For the PF Roller, Front Paper Guide, Rear Paper Guide and etc.
4	G-71	1304682	Grease	For the Carriage Unit and Carriage Shaft.
5	PG Adjustment Gauge	1276333	Gauge	A gauge exclusively used to make PG Adjustment. Check the correction value by energizing it in the same way as for Stylus Photo R800.
6	PF Tension Measuring Tool	1231678	Measuring tool	Used to check whether or not the tension of the PF Drive Belt is within the specified value. If load is greater than the specified value, the PF Motor may generate heat, burning off the coil. Reversely, if load is less than the specified value, the paper feed position may shift.

**Table 5-5. List of Tools**

No.	Name	Part Code	Category	Overview
7	PF Roller Shaft Position Adjustment Jig	1304993	Adjusting jig	Used to check whether or not the deflection amount of the PF Roller Shaft is within the specified value. Adjustment values are confirmed in a pair with the level block.
8	Level	1304994	Adjusting jig	Used to check whether or not deflection amount of the PF Roller Shaft is within the specified value. Adjustment values are confirmed in a pair with the PF Roller Shaft Position Adjustment Jig.

Note : For tools required for the Colorimetric Calibration, [See Section 5.2.4 on page 147.](#)

## 5.2 Adjustment

This section explains the adjustments that do not use the Adjustment Program.

### 5.2.1 PF Belt Tension Adjustment

When either of the following parts has been removed or replaced, this adjustment must be performed to reduce load on the PF Motor and to secure paper feed accuracy.

- PF Motor
- PF Roller Shaft

The PF Tension Measuring Tool is used for this adjustment.



Figure 5-1. PF Tension Measuring Tool

#### 5.2.1.1 PF Belt Tension Adjustment Method



Proper measurement may be interrupted by sounds picked up from around. Make measurement in silent environment.

1. Secure the PF Motor to the Printer Mechanism, and install the Drive Belt on the Gear of the PF Scale and the Pinion Gear of the PF Motor.
2. Press the [POWER] button. The LCD of the Measuring Tool displays No. 0 and No. 1.
3. From among No. 0 to No. 9, select the channel you want to store its setting by pressing the [SELECT] button. The initial value may be selected as the channel.)
4. Press the [WEIGHT] button. The initial value will be displayed. Type the ten-key pad so that "1.2g/m" is displayed.
5. Press the [WIDTH] button. The initial value will be displayed. Enter "5.0 mm" with the ten-keypad.
6. Press the [SPAN] button. The initial value will be displayed. Enter "1.89in" with the ten-keypad.

7. Bring the Microphone as close as possible to the center of the Timing Belt.

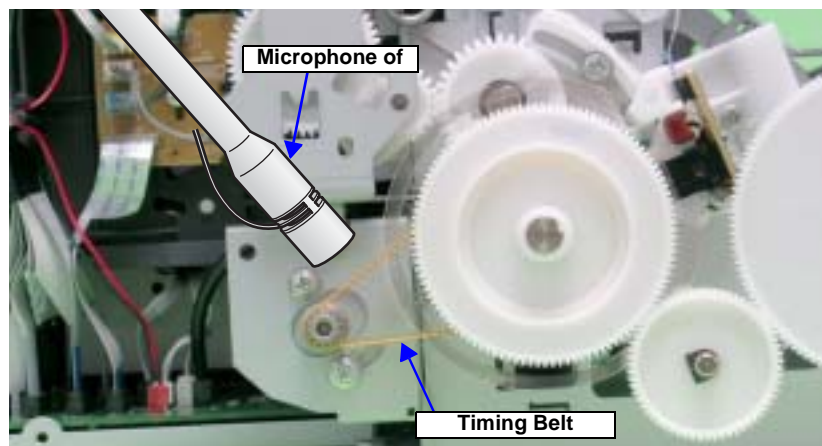

Figure 5-2. Microphone Position



Standard Value:  $9.0 \pm 2N$  (7.0 ~ 11.0N)



- Even if the Timing Belt is flipped, the LCD screen may not change at all. In this case, flip the Timing Belt again after a few seconds have passed.
- If measurement results differ greatly from each other, acoustic sounds may not be picked up properly in any of the measurements. Therefore, flip the Timing Belt again with the tweezers, and record the value at which two measurement results are approximate. Displaying errors in the range 1/100 to 5/100, the Measuring Tool has high reliability.

CAUTION



As the Drive Belt is flipped with the tip of tweezers in the following steps, carefully choose the flipping position so that the Belt will not make contact with the Microphone by reaction of flipping.

8. Press the [MEASURE] button. ("----" is displayed on the LCD screen.)
9. Put the tip of the tweezers on the Drive Belt, and flip it downward in that position. The "----" displayed on the LCD will become wave pattern during the measurement. When it has finished, the measurement result will be displayed by "N" (Newton) after the beep. This jig can pick up and measure sounds accurately, regardless of the flipping force.
10. Repeating 8 and 9, delicately shift the variable part of the PF Motor mounting position to adjust the tension until the tension falls within the allowable standard value.

## 5.2.2 PG Adjustment

When any of the following parts has been removed or replaced, this adjustment must be performed to secure the specified clearance between the print surface of the Print Head and paper.

- Print Head
- Carriage Unit
- Carriage Shaft
- Parallelism Adjust Bushing (Including the case when just moved it)

In this adjustment, use the same Adjustment Gauge on the left and right sides.

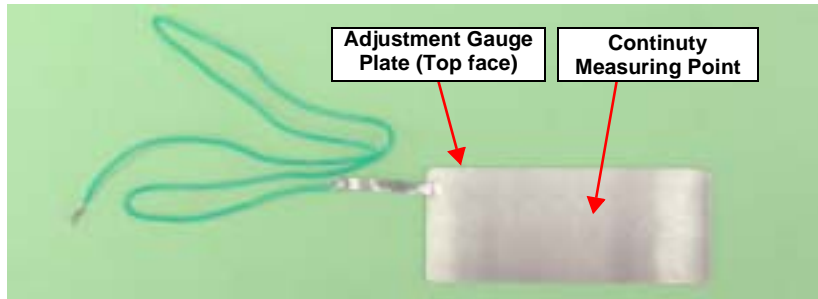

Figure 5-3. Adjustment Gauge

**CAUTION**



- Do not touch the Adjustment Gauge Plate surface with bare hands.
- If the Adjustment Gauge Plate surface is stained by ink or, etc wipe it with a soft cloth.

### 5.2.2.1 PG Adjustment Method

**CAUTION**



- Before starting PG adjustment, completely wipe drops of ink around the Print Head. Remaining drops of ink will stick to the continuity measurement portion of the Adjustment Gauge, and generate continuity before the continuity measurement portion makes contact with the metal frame around the Print Head, interrupting accurate PG Adjustment.
- As the ink in the Print Head may stick fast and damage the Print Head during PG Adjustment, make the continuity time detected with a tester as short as possible. (Maximum 3 minutes)

1. Install the printer on a level base.

**CAUTION**



Place the printer on a level, warp-free table. Normal PG Adjustment cannot be performed on a warped table.

2. Connect the Tester to the printer frame and Adjustment Gauge.

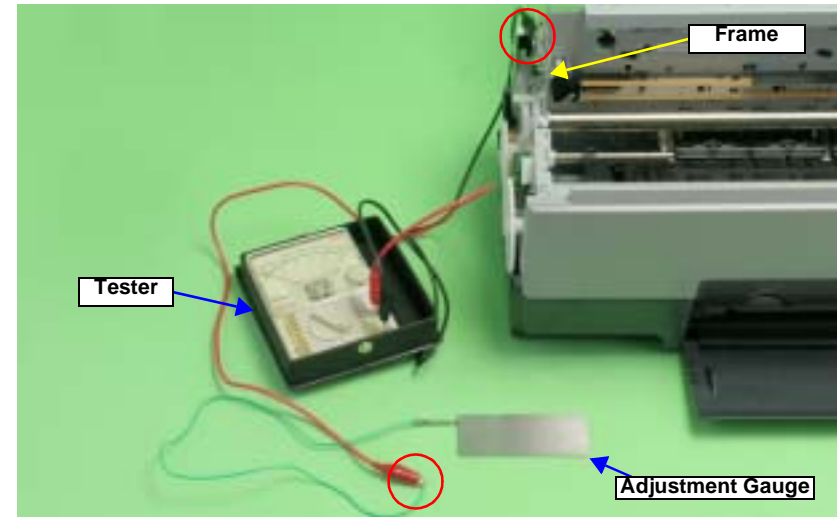

Figure 5-4. Connecting the Tester

3. Load unused Ink Cartridges of all colors into the Carriage Unit.
4. Loosen the screw that secures the Parallelism Adjust Bushing.
5. Turn the Parallelism Adjust Bushing upward to match the frame edge and the bottom of the Parallelism Adjust Bushing gear.



**When the Parallelism Adjust Bushing is turned upwards, the frame rises up and PG narrows. Make sure that the frame does not come into contact with the Print Head when performing the following procedure.**

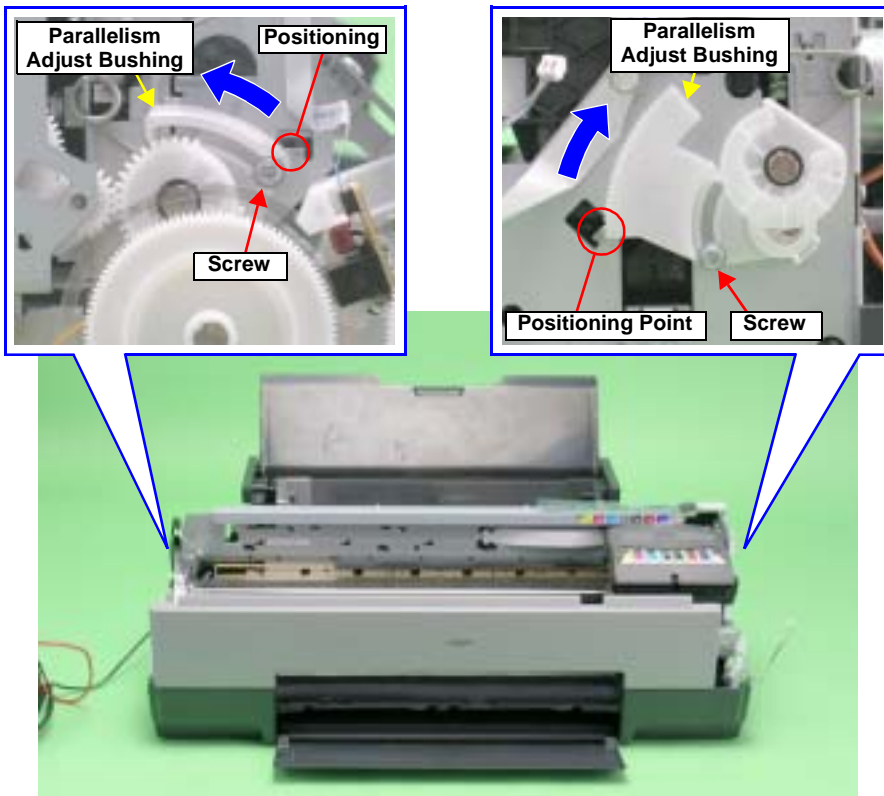

Figure 5-5. Setting the Parallelism Adjust Bushing

6. With its conductor connection portion up, set the Adjustment Gauge in the specified position (on the left side of the Front Paper Guide).
  - Setting Position
    - Rear direction: Match the rear end of the Gauge with the Driven Roller Shaft of the Upper Paper Guide.
    - Left direction: Release the left end of the Gauge from the Tab on the Front Paper Guide in [Figure 5-6](#)

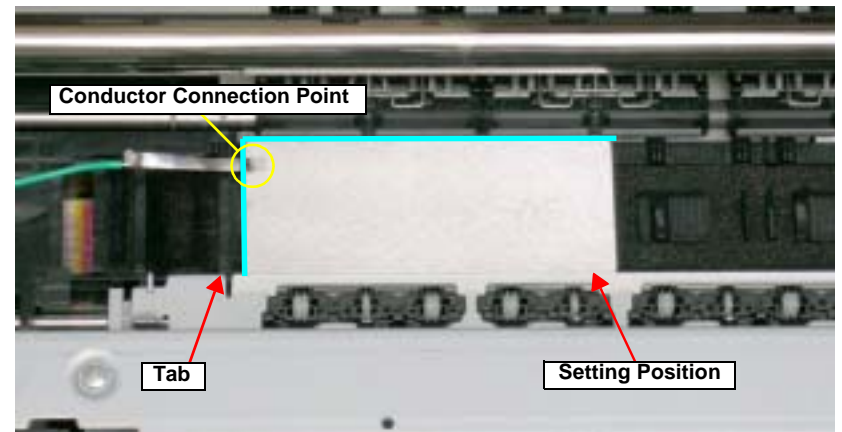

Figure 5-6. Setting the Adjustment Gauge

7. Move the Carriage Unit onto the Adjustment Gauge.
  - Moving position: Match the left end of the Gauge with the left end of the Carriage Unit.

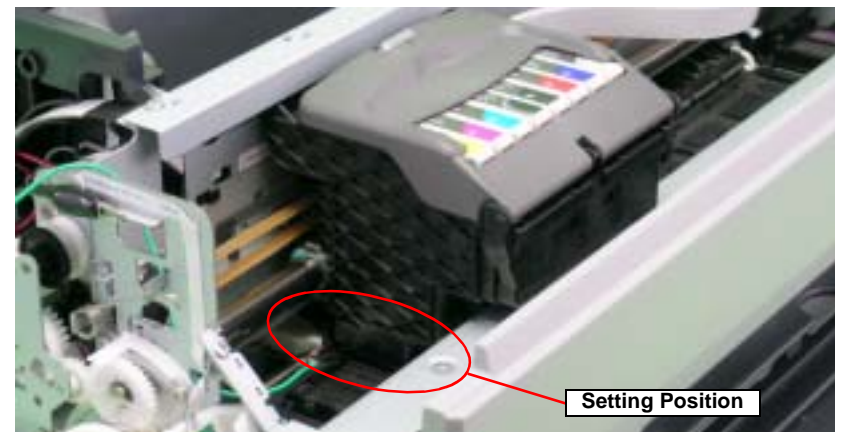

Figure 5-7. Moving the Carriage Unit



- To set the PG position to the "--" position, turn the PG Cam on the right end of the Carriage Shaft clockwise so that the point marked "--" faces down.

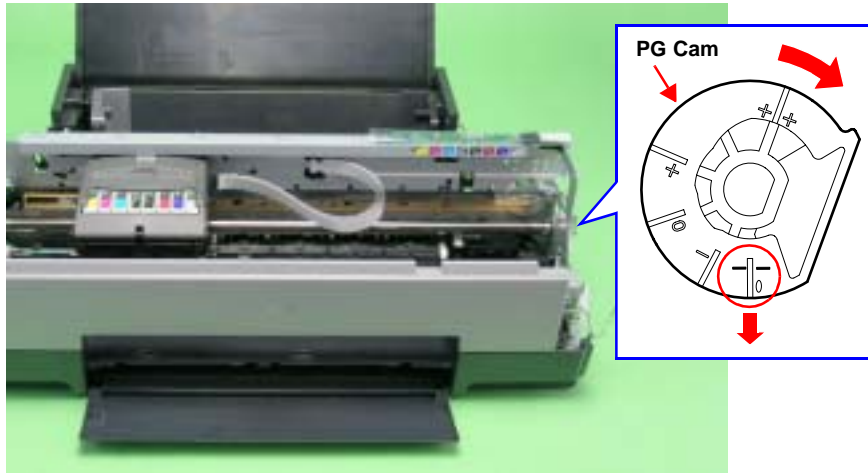

Figure 5-8. Markings of the PG Cam



■ PG Standard Value	
• PG -- (Minus Minus)	:1.05mm~1.25mm
• PG - (Minus)	:1.2mm~1.4mm
■ Adjustment Resolution	:0.06mm

- Lower the Gear of the Parallelism Adjust Bushing on the left side of the frame stepwise, and confirm continuity. When continuity is confirmed, define the position where the Gear was raised one step up from the continuity position (where continuity is lost) as the left side PG position. Move the Parallelism Adjust Bushing at least twice to confirm that the continuity position and the non-continuity position are the same.



The following figure shows the states of the Adjust Parallel Bushing of the left side of the frame and the PG. This also applies to the Adjust Parallel Bushing on the right side of the frame.)

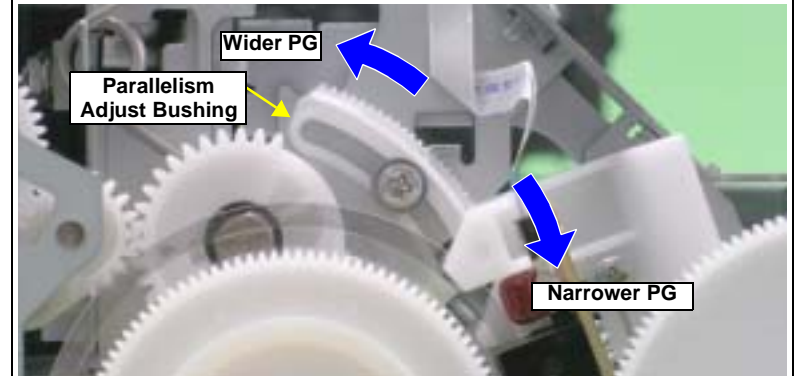

Figure 5-9. Relationship between Parallelism Adjust Bushing and PG

- To set the PG position to "0" or more, turn the PG Cams on both ends of the Carriage Shaft CCW so that the point marked "0" (or "+" or "++") faces down.



11. With its conductor connection portion up, set the Adjustment Gauge in the specified position (on the right side of the Front Paper Guide).
- Setting Position
    - Rear direction: Match the rear end of the Gauge with the Driven Roller Shaft of the Upper Paper Guide.
    - Right direction: Release the right end of the Gauge from the Tab on the Front Paper Guide in Figure 5-10.

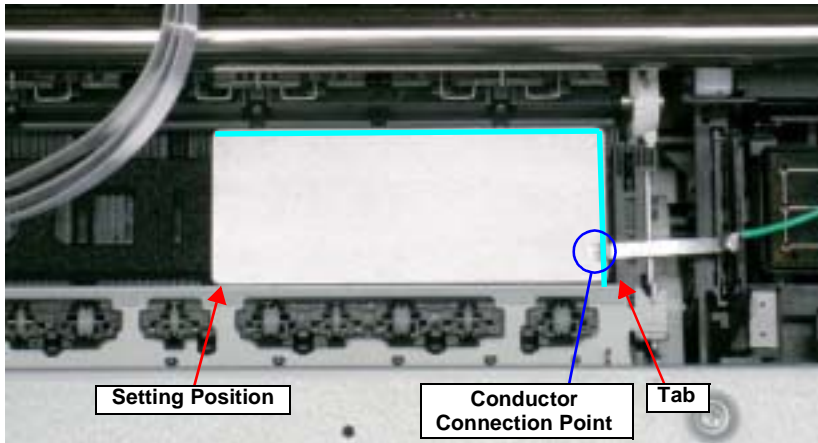

Figure 5-10. Setting the Adjustment Gauge

12. Move the Carriage Unit onto the Adjustment Gauge.
- Moving position
    - Match the right end of the Gauge with the right end of the Carriage Unit.



Figure 5-11. Moving the Carriage Unit

13. Return the PG position to "--".
14. As in Step9, move the Parallelism Adjust Bushing on the right side of the frame to set the right side PG position.
15. Set the PG position to 0 or more.
16. Set the Adjustment Gauge on the left side of the Front Paper Guide.
17. Move the Carriage Unit onto the left side Adjustment Gauge.
18. Return the PG position to "--".
19. Check continuity again at the PG position on the left side. If the PG position is not out of position, tighten the Parallelism Adjust Bushing with the screws to end the adjustment. If it is out of position, repeat the adjustment procedure from step 9.

### 5.2.3 PF Roller Shaft Center Support Position Adjustment

This adjustment must be performed to compensate the deflection amount on the PF Roller Shaft and to maintain an appropriate paper feed amount when the following parts are removed and replaced.

- PF Motor
- PF Roller Shaft

The PF Roller Shaft Position Adjustment Jig and Level block are used for this adjustment.



**A substitute level block can be used if its surface accuracy is within 50 $\mu$ .**

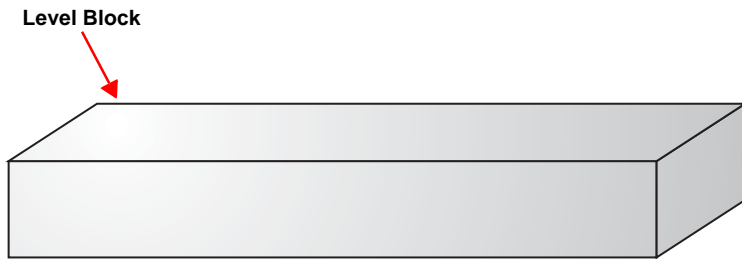

Figure 5-12. PF Roller Shaft Center Support Position Adjustment Jig and Level Block

#### 5.2.3.1 How to Adjust the PF Roller Shaft Center Support Position

1. Before performing this adjustment, remove the following parts:
  - Lower Housing
  - ASF Assy See Section 4.2.4 on page 83.
  - Board Assy See Section 4.2.5.1 on page 87.
  - Carriage Unit
2. Install the printer on a level base.

**CAUTION** Place the printer on a level, warp-free table. This adjustment cannot be performed correctly if it is performed on a warped table.

3. Set the PF Roller Shaft Position Adjustment Jig in place on the Level block, and perform zero adjustment.
  - Long hand position: Turn the dial to adjust the "0" position on the scale to the long hand position with the jig set in place on the Level block.
  - Short hand position: Check it.

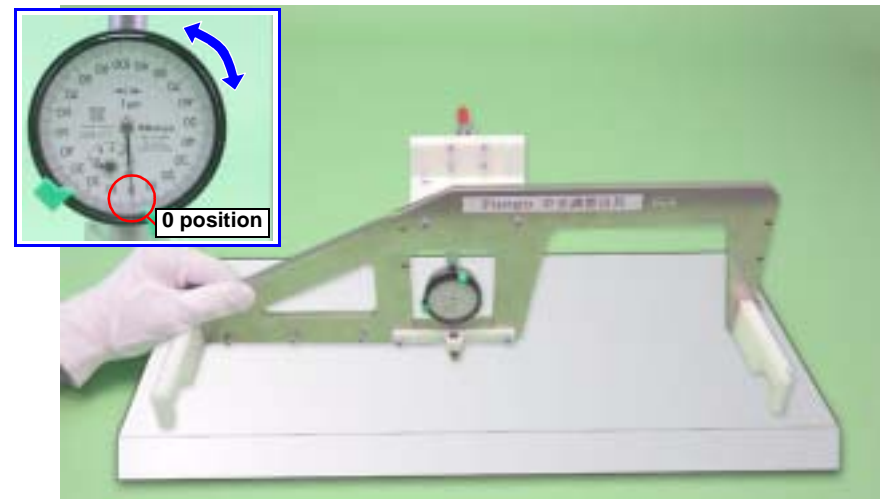

Figure 5-13. Setting the PF Roller Shaft Position Adjustment Jig (1)

4. Loosen the screws that secure the Center Support Bushing Cam and the Center Support Bush.

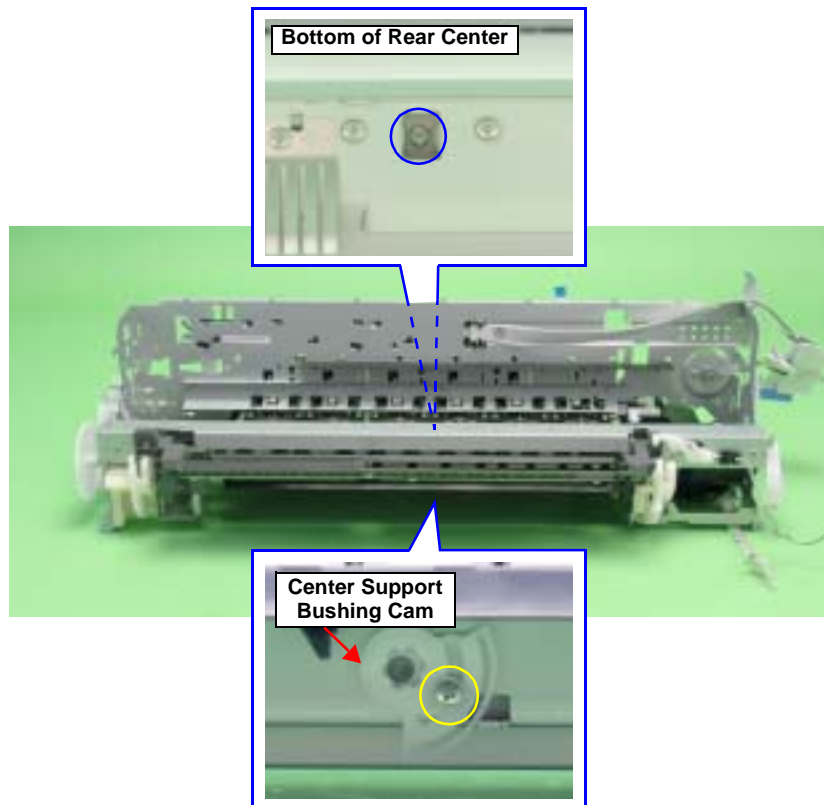

Figure 5-14. Center Support Bushing Cam and the Screw



**Check for any dirt on the PF Roller Shaft when performing the following procedure.**

5. Set the jig in place on the PF Roller Shaft as shown in the figure below.
  - Left side: Inside of PF Roller left end (E-ring)
  - Right side: Clearance between PF Roller right end (Right Bushing 8) and left end of Upper Paper Guide
  - Center: Clearance between the 2nd Upper Paper Guide and 3rd one from the left

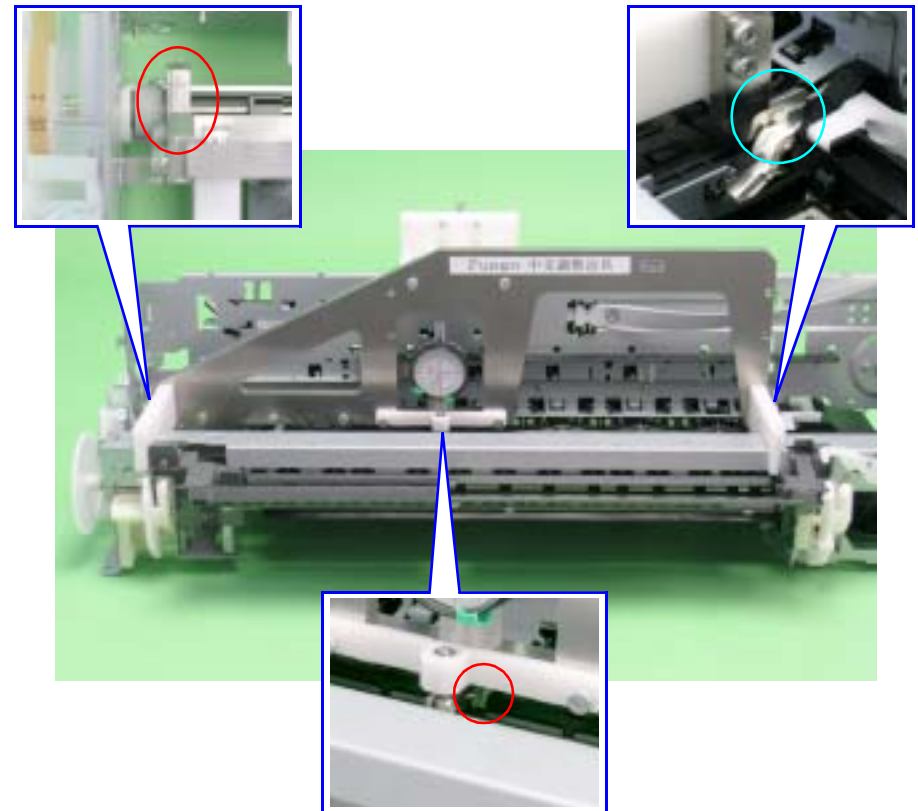

Figure 5-15. Setting the PF Roller Shaft Position Adjustment Jig (2)

6. Turn the Center Support Bushing Cam so that the long hand position is +30 $\mu$  from the "0" adjustment position.



- Standard Value: 30  $\pm$  50 $\mu$
- Adjustment Resolution: 50 $\mu$



- +30 $\mu$  must be set to compensate for the thickness of the coating on the PF Roller Shaft.
- Make sure that the position of the short hand is the same as at "0" adjustment.



The figure below shows the positional relationship between the Center Support Bushing Cam and the Dial Gage.

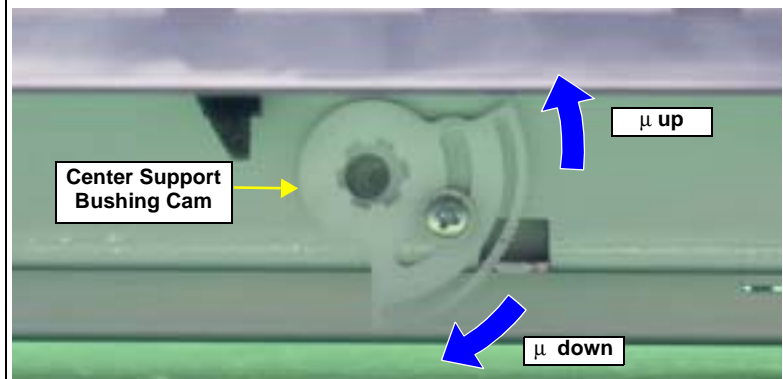

Figure 5-16. Positional Relationship between Center Support Bushing Cam and the Dial Gage

7. Tighten the Center Support Bushing Cam and the Center Support Bushing with the screws.



**Check the adjustment value again as it deviates slightly when the screw is tightened.**

The following page shows print samples when adjustment of the PF Roller Shaft Center Support Positions are inside and outside the specified value range.



Figure 5-17. Outside the Specified Value Range



Figure 5-18. Inside the Specified Value Range



## 5.2.4 Colorimetric Calibration

This calibration is performed to compensate the ink discharge amount when the following parts are replaced:

- Print Head
- Main Board
- PS Board

The following tools are used for this adjustment:

- Photo paper (A4 or letter-size): 1 sheet (for printing Calibration Chart)
- Plain paper (A4 or letter-size): 1 sheet (for checking the nozzles)
- PC (OS: Windows XP/Me/2000/98)

The following drivers must be installed on the PC:

- Printer Driver for Stylus Photo R1800
- USB Driver for the Calibrator  
(Interface other than USB are not available.)
- Calibrator (GretagMacbeth Eye-One with a UV filter)
  - Scanning ruler (supplied with the Calibrator)
  - Calibration plate that contains a white reference tile (Calibrator accessory)
- Colorimetric Calibration Tool for Stylus Photo R1800 (program)
- Black paper (A4 size or larger) (A paper printed in solid black can also be used.)

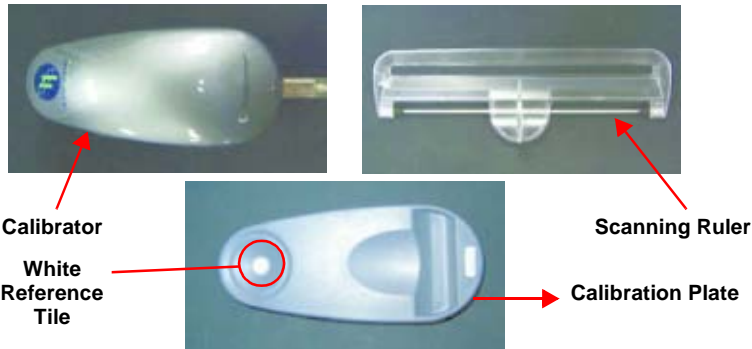
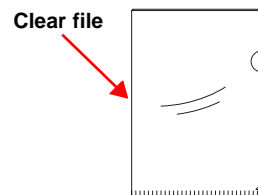

Figure 5-19. The Calibrator and the Accessories

The following tool is used to mail the Calibration Chart when measuring color at a place different from the repair work site.

- Clear file
- Plain paper (A4 or letter-size) : 1 sheet



### 5.2.4.1 Overview of the Colorimetric Calibration

Purpose

Measuring the color of the ink discharge amount information and registering/controlling this information improves calibration accuracy and ensures consistent color quality.



**As color measurement is performed with the fully assembled product, the electrical characteristics which are unique to each Main/Power Board are also compensated in addition to the Print Head.**

- To reduce unit-to-unit and mode-to-mode variations in color.
- To improve the accuracy of the Ink Counter.  
The Color ID can improve the Ink Counter accuracy, which reduces the running cost of ink.

Colorimetric Calibration Technology

■ The Principle

The ink discharge amount characteristic of a printer is measured by measuring color difference (L\*a\*b\*) of a printed chart with a calibrator. Created Color ID information based on the obtained L\*a\*b values is stored on the printer. When printing, the printer sends the Color ID to the printer driver to compensate the number of ink droplets (dot generation rate) for each of nine<sup>1</sup> different sized droplets of each color. This method allows mass-produced printers to provide consistent print quality reducing unit-to-unit variation.

Example: Compensation of Ink Amount Ejected from a Print Head (dot generation rate)

- When the standard printer generates ten dots.  
If the ink discharge amount is insufficient by 10%, this is compensated by generating 11 dots.

Note 1: Three different sized droplets (small, medium, large) for each of three waveforms (VSD1, 2, 3)

■ Head ID

In the conventional color calibration with a Head ID, the print head characteristics (weight of discharged ink) are measured and compensated. The following shows the correlation between conventional Head ID adjustment and Colorimetric Calibration.



**Table 5-6. The Difference in Calibration Method between Head ID and Colorimetric Calibration.**

Conventional Head ID adjustment	Colorimetric Calibration
In the print head manufacturing process, ink discharge amount of each head is actually measured to get individual characteristic information. The information is stored on the printer as Head ID to control the print head.	By printing and measuring a color chart, a variation from the standard machine is obtained and registered as the correction value (Color ID) to control the amount of ink droplets.

Note : Calibration processes of "Color ID" and "Head ID" are exactly the same. Calibration can be made by transmitting the ID to printer drivers and changing dot generation rate in reference to the same calibration table.



**Make sure not to confuse Head ID with Color ID.**

- **Head ID**  
An ID information specific to individual print head. It is indicated on the Head QR Code Label attached to the print head.
- **Color ID**  
An ID information specific to individual printer. It is obtained by the Colorimetric Calibration.



**Before performing Colorimetric Calibration, the conventional Head ID must be pre-registered. This is because the Head ID contains information to create a waveform to drive the head, which is also required for the Colorimetric Calibration.**



If you do not perform Colorimetric Calibration after performing Head ID adjustment, the printer will be controlled only by the Head ID, which affects the following.

- **Ink Counter**  
The ink consumption counter table switches from the table for Color ID to the one for Head ID. This change causes an ink out error to occur 2 to 5 percent earlier than when using the table for Color ID.
- **Color Quality**  
Color quality will be at the same level as that of printers adjusted by the conventional Head ID, and the same color quality as mass-produced printers cannot be maintained.

- Supplement: Regarding remaining ink amount  
When the Ink Counter detects ink out, a certain amount (safety margin) of ink is still remaining in the cartridge to prevent the print head from damages caused by printing without ink. This safety margin is important especially for a printer that discharges larger amount of ink. The figure below illustrates the concept of this safety margin.

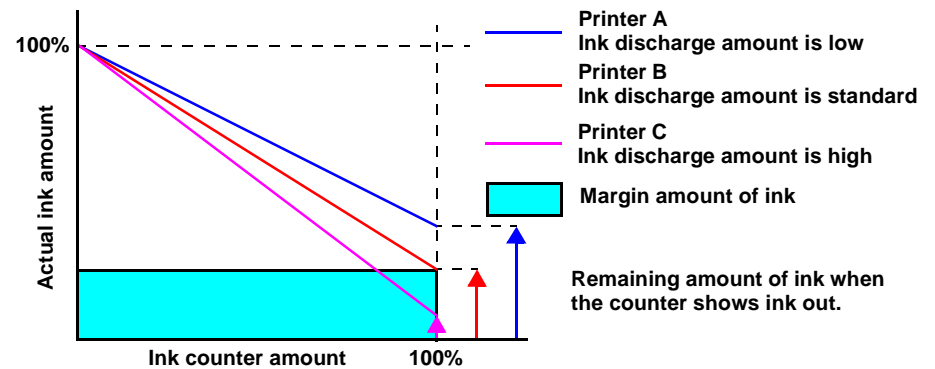

**Figure 5-20. Concept of Remaining Ink Amount**

### 5.2.4.2 Adjusting Method of the Colorimetric Calibration



The Color ID Calibration Chart is designed to be printed in a completely non-compensated state. Therefore, there is no need to delete an existing Color ID from EEPROM when printing out a Calibration Chart.

When color measurement is performed at the same place as the repair work site, calibration is batch-processed. When color measurement is performed at a place different from the repair work site, calibration is performed by separate processes. The following illustrates the overall workflow.

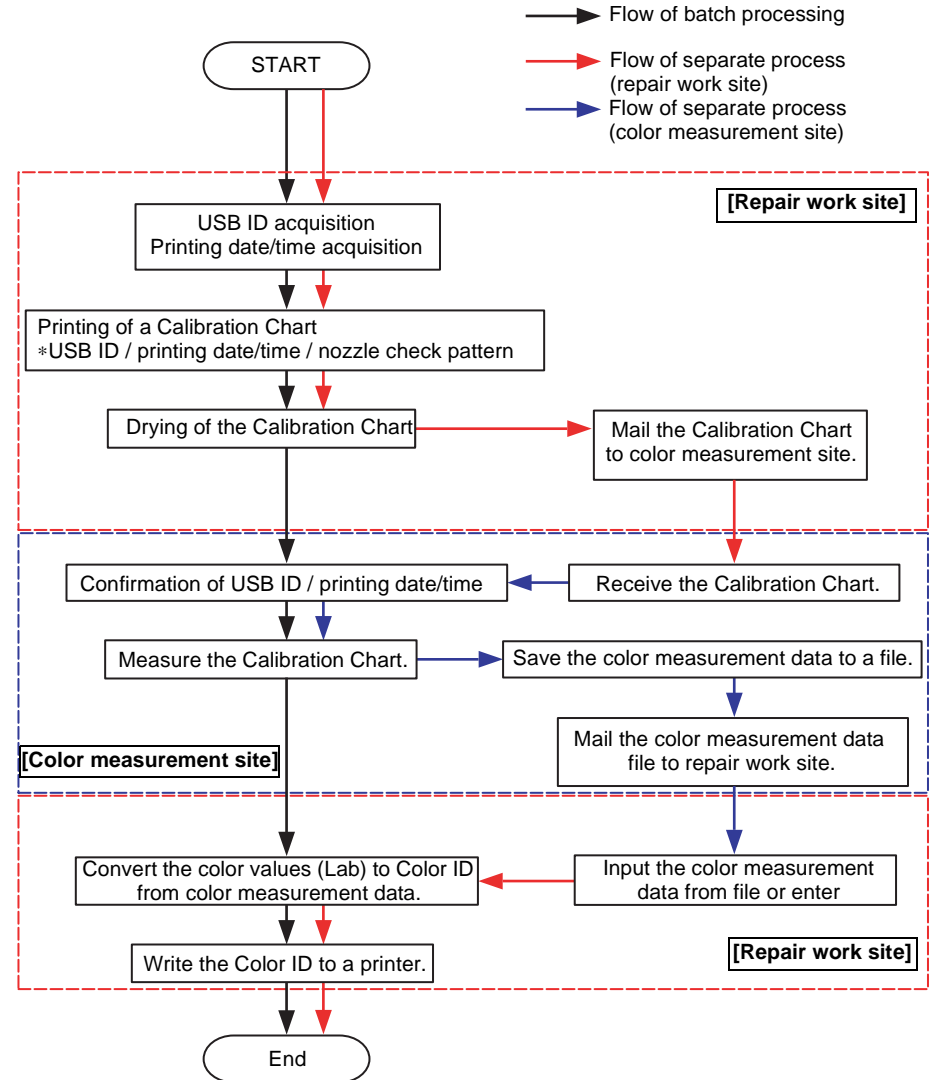

Figure 5-21. Overall Workflow

**When Measuring Color at a Place the Same as the Repair Work Site**

1. Start up the Colorimetric Calibration Tool for Stylus Photo R1800 on a PC, and click [Perform entire process].

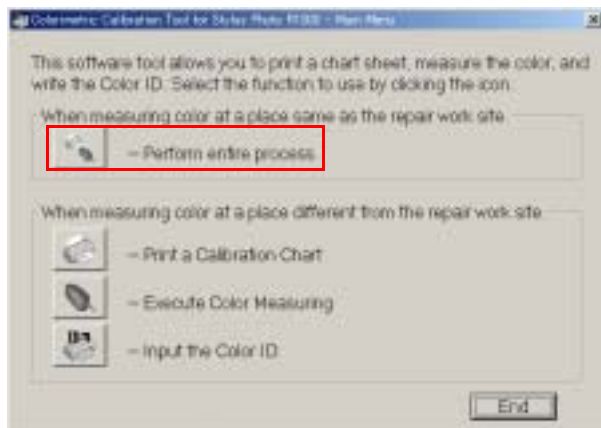

Figure 5-22. Perform Entire Process

The following shows the process when [Perform entire process] is clicked.

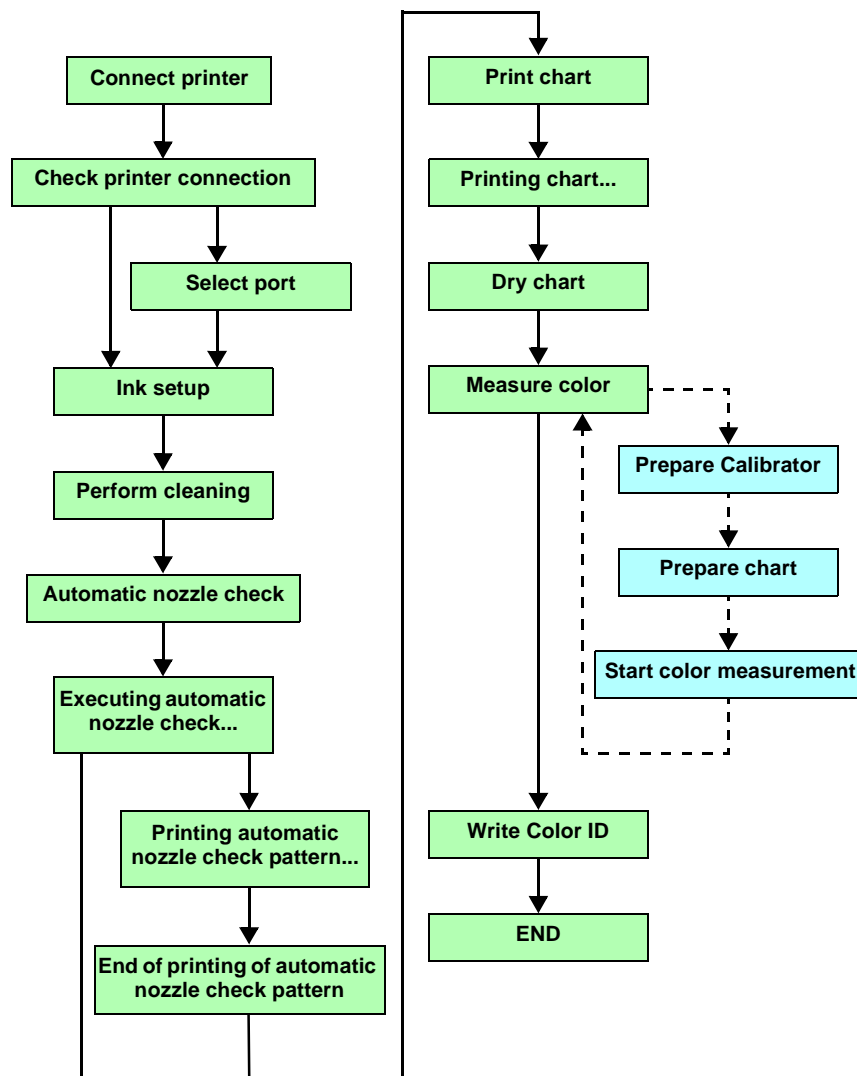

Figure 5-23. Entire Process Workflow

2. Connect the printer to the PC by a USB cable, and click [Next].

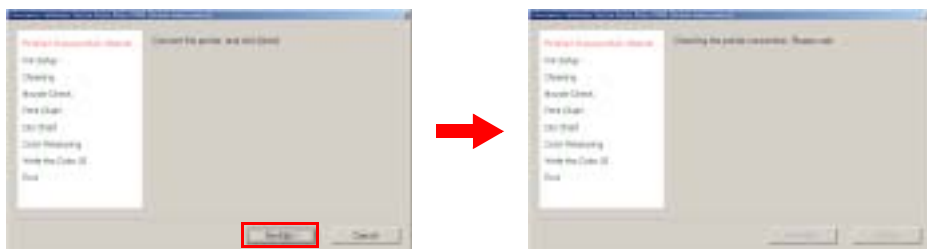

Figure 5-24. Checking the Printer Connection

3. The printer driver for Stylus Photo R1800 is automatically detected, and the USB ID is automatically acquired.



- The remaining amount of the ink is checked before the USB ID is acquired. If there is an ink cartridge(s) with a remaining amount of ink of 30% or less (ink low/ink out states), a warning message is displayed.
- As the USB ID is used to recognize printers when entering color measurement values, do not change the USB ID after performing the Colorimetric Calibration.



- Only printers connected with USB are recognized.
- When two or more printers are currently connected, the screen changes to the "port selection" screen.

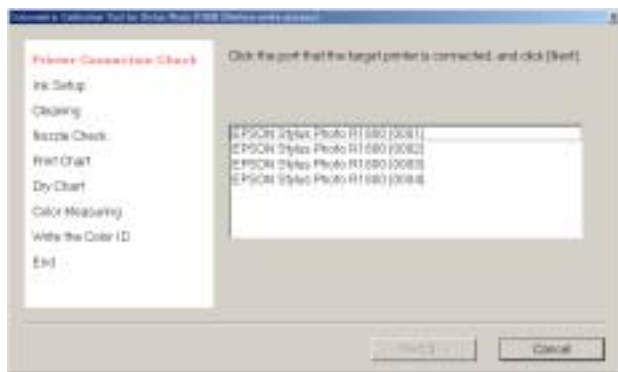
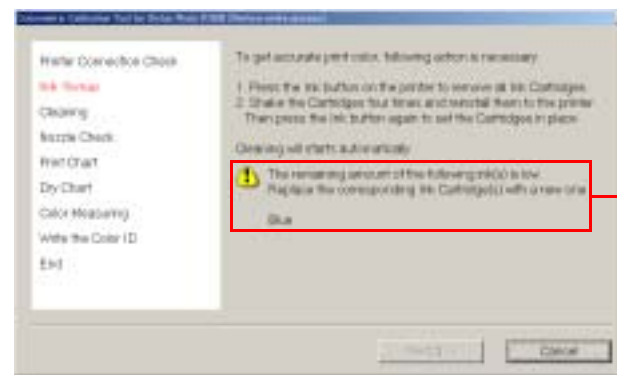

Figure 5-25. Selecting the Port

4. To prevent inks from settling down at the bottom, remove all ink cartridges, shake them at least four times, and reinstall them to the printer.



Warning message

Figure 5-26. Ink Setup

5. To prevent inks from settling down at the bottom, cleaning cycles shown below are performed.

- Exchange CL (once) + CL3 (once)

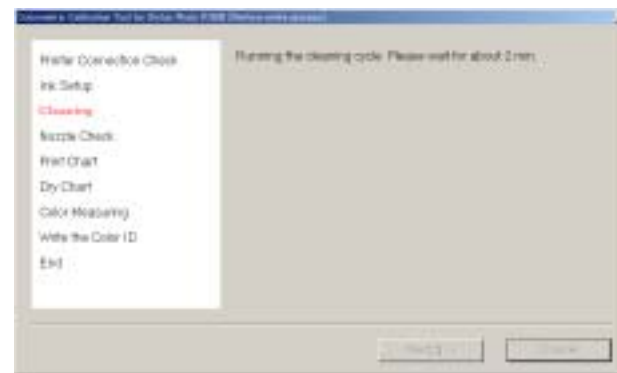

Figure 5-27. Cleaning

- Load one sheet of A4 or letter-size plain paper, and click "Next" to execute the automatic nozzle check.

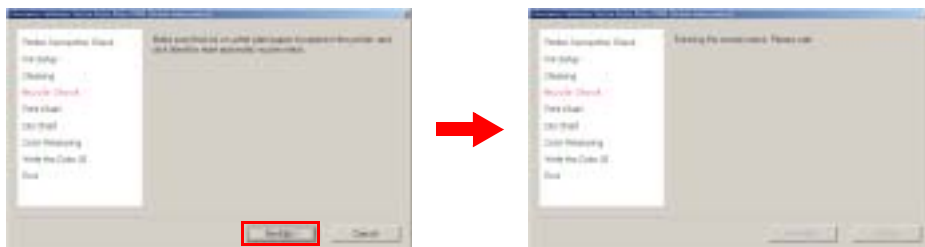

Figure 5-28. Automatic Nozzle Check



The following error message is displayed if the automatic nozzle check fails three times in a row:

- "The automatic nozzle check has failed. There may be a problem with the print head." The print head, ink cartridge(s), or ink system may be damaged.



If an ink sensor abnormality is detected during execution of the automatic nozzle check, the following error message will be displayed:

- "The automatic nozzle check has finished unsuccessfully. Click OK to start a nozzle check manually."
- Click [OK] to print the nozzle check pattern.



Figure 5-29. Manual Nozzle Check

- Check the printed nozzle check pattern. If there are no broken lines or missing segments, click [Next]. If there are broken lines or missing segments, click [Cleaning], and return to [Step 5](#).

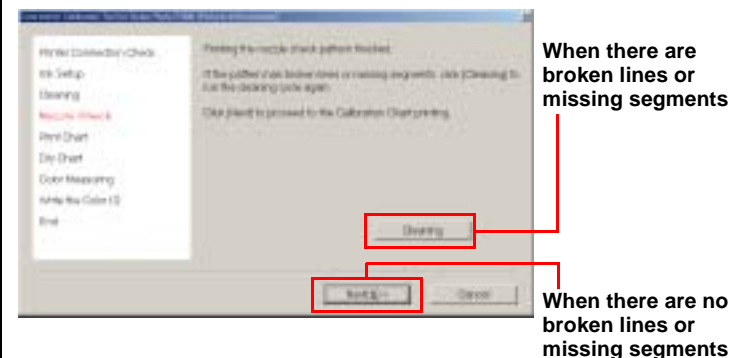

Figure 5-30. Completion of Printing of Nozzle Check Pattern

7. Load one sheet of A4 or letter-size Photo paper, and click "Next" to print the Calibration Chart.

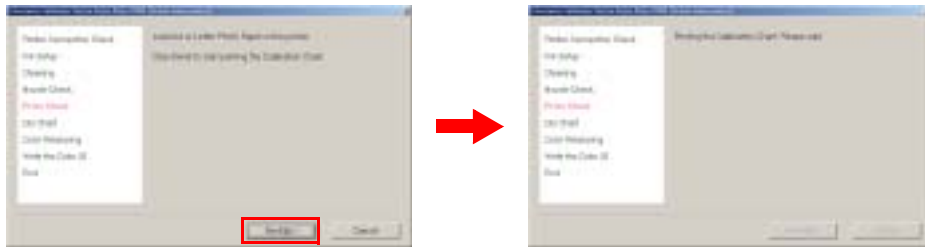

Figure 5-31. Printing a Calibration Chart



The recommended air temperature range for printing a Calibration Chart is 15°C to 28°C.

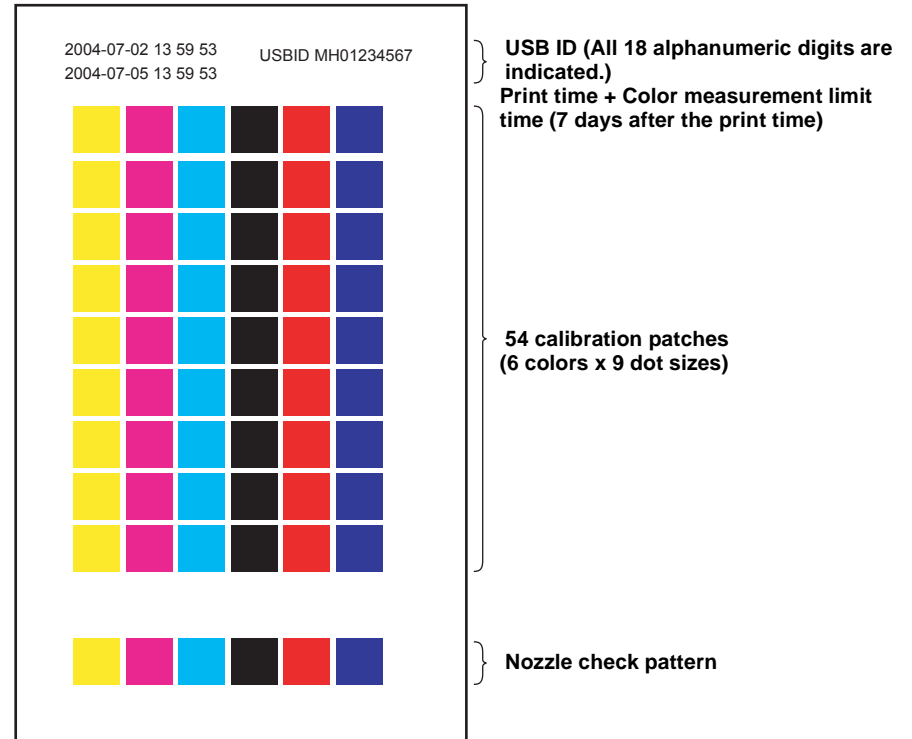

Figure 5-32. Illustration of Calibration Chart



- After the Calibration Chart is printed, allow it to dry for five minutes. During this time, check the nozzle check pattern on the chart. If there are broken lines or missing segments, click [Print Calibration Chart again], and return to [Step 5](#). If there are no broken lines or missing segments, click [Next].

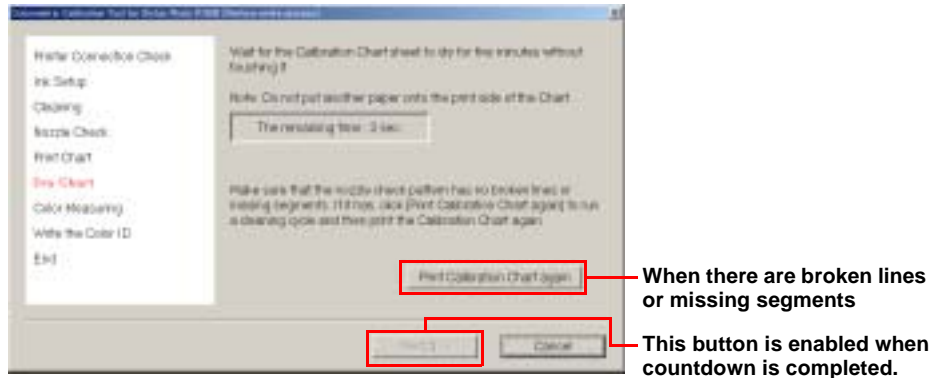

Figure 5-33. Drying the Chart

- Connect the Calibrator to the PC and click [Color Measuring]. The color measurement procedure screen operated by the Calibrator control plug-in (DLL) is displayed on screen overlapping the Colorimetric Calibration Tool.

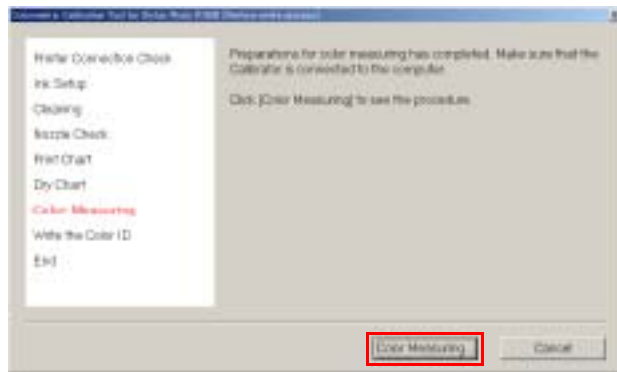

Figure 5-34. Color Measurement

- Place the Calibrator on the calibration plate, and click [Calibrate]



Figure 5-35. Preparing the Calibrator



- The white reference tile on the calibration plate should be clean. Clean off any dirt with alcohol or other organic solvent.
- The calibration plate and the Calibrator are used as a pair. Do not use a calibration plate supplied with another Calibrator.

11. After confirming that you are within the color measurement time limit, place the Calibration Chart sheet on a black paper, put the scanning ruler on the Chart sheet, then click [OK].

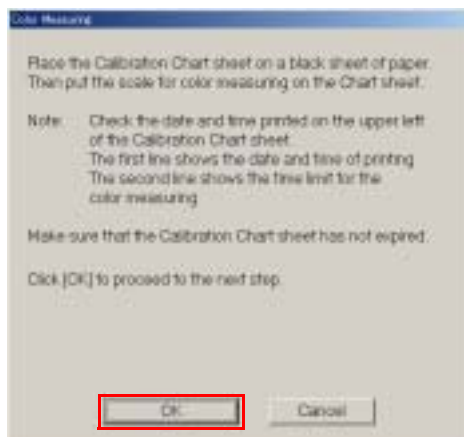
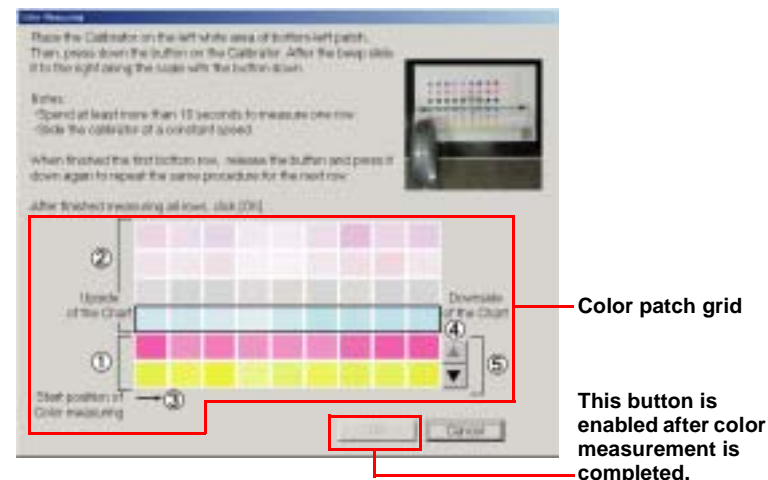

Figure 5-36. Preparing the Calibration Chart

12. Follow the on-screen messages to measure the Chart. After the color measurement is finished, click [OK].



- ① Color measurement "completed" rows Patches in the completed rows are displayed in colors created according to the measurement result.
- ② Color measurement "not completed" rows Rows that have not been measured are displayed in pale color.
- ③ Arrow Indicates the start position of color measuring.
- ④ Cursor Automatically moves up when color measurement of a row is completed.
- ⑤ Scroll buttons Scroll the cursor up or down. (These buttons are available for already measured rows or the row currently being measured.)

Figure 5-37. Starting the Color Measurement

## CAUTION



- Be sure to start the measurement from the top side of the chart.
- Take more than 10 seconds to measure one row.
- Slide the calibrator at a constant speed.
- During color measurement, do not allow the Calibrator to rub against unmeasured patches on the chart.
- Prevent the ruler and Calibrator from coming off the chart sheet during color measurement. Doing so will cause incorrect color measurement.
- During color measurement, measure only the patches on the chart sheet. Do not measure other parts such as the USB ID text string.
- When there is an error possibility in measuring color, a warning mark (⚠) appears at the patch in question. In such case, make sure to measure the row that includes the patch with a warning mark again.
- If the number of scanned patches does not match the number of patches on a single row, the cursor stops at that row, the error mark (✖) appears on all of the patches on that row, and the following error message is displayed:
  - "Color measuring by Eye-One calibrator has failed. Measure colors of the failed row again."

13. Click [Next], and write the Color ID to the printer.



Figure 5-38. Writing of Color ID

## CHECK POINT



It takes about three minutes to write the Color ID to the printer.



Figure 5-39. Writing of Color ID in Progress

- When the following screen is displayed, click [End], and turn the printer OFF then back ON again to end the adjustment. This action reflects the color measurement values on the printer.



Figure 5-40. END

### When Measuring Color at a Place Different from the Repair Work Site

#### 1. Repair work site

- Start up the Colorimetric Calibration Tool for Stylus Photo R1800 on the PC, and click [Print a Calibration Chart].

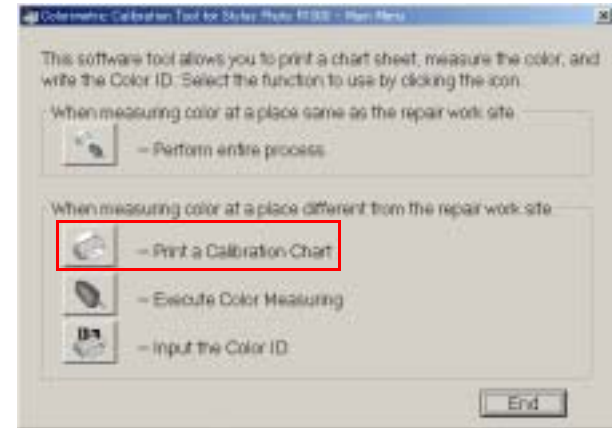

Figure 5-41. Printing a Calibration Chart

The following shows the process when [Print a Calibration Chart] is clicked.

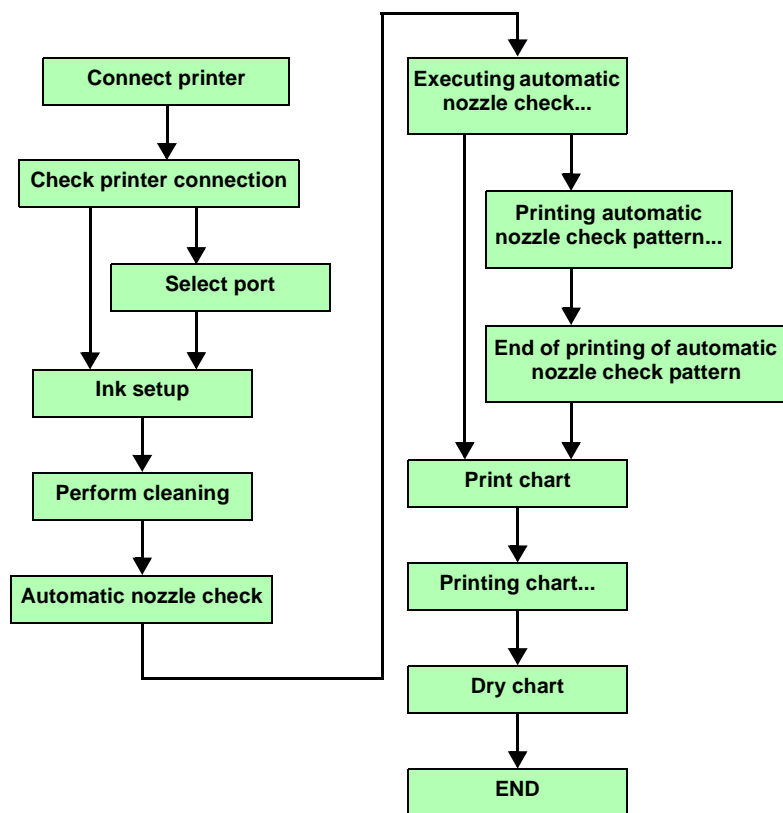

Figure 5-42. Printing a Calibration Chart Workflow

- Execute [Step 2 ~ 8](#) of the procedure “[When Measuring Color at a Place the Same as the Repair Work Site](#)” (p150) to make a Calibration Chart.
- When the following screen is displayed, click [End], and follow the on-screen instructions to mail the Calibration Chart to the repair work site.



Figure 5-43. END

2. Color measurement work site

1. Start up the Colorimetric Calibration Tool for Stylus Photo R1800 on the PC, and click [Execute color measuring].

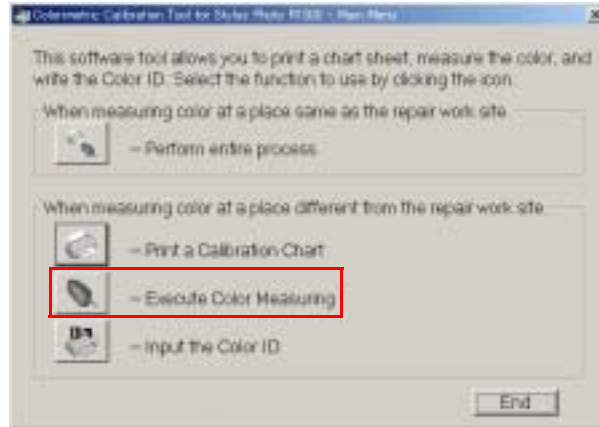

Figure 5-44. Color Measurement

The following shows the process when [Execute color measuring] is clicked.

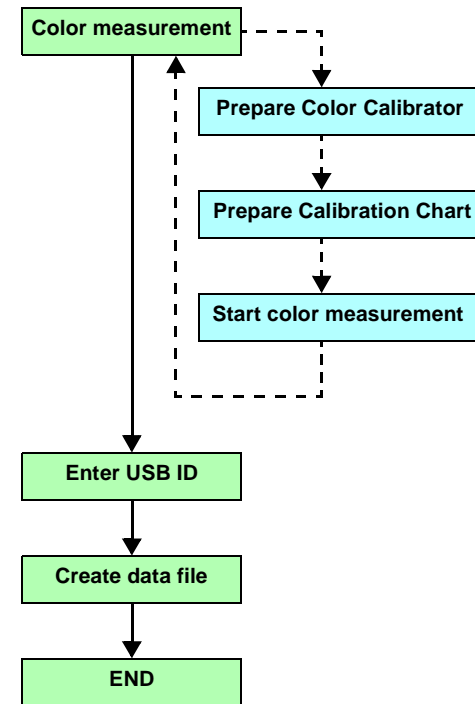

Figure 5-45. Color Measurement Workflow



2. Execute [Step 9 ~ 12](#) of the procedure “*When Measuring Color at a Place the Same as the Repair Work Site*” (p150) and execute color measurement on the Calibration Chart that was mailed.
3. Enter the USB ID printed on the Calibration Chart's header in the edit box using 1-byte characters, and click [Next].

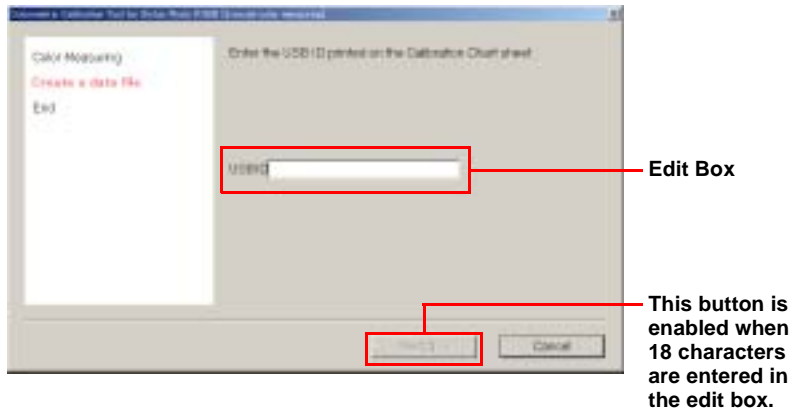

Figure5-46. Entering the USB ID

4. Click [Save...] to save the color measurement data.
  - Color measurement data file: xxxxxxxx.data  
(It is recommend to enter the product's serial No. as the file name for management purposes.)

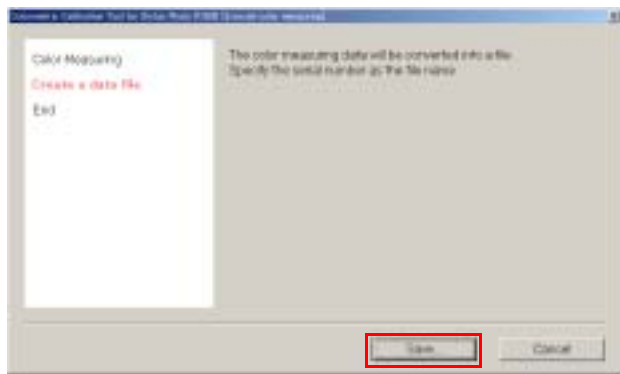

Figure 5-47. Creating a Data File

5. When the following screen is displayed, click [End], and mail the color measurement data file to the repair work site.

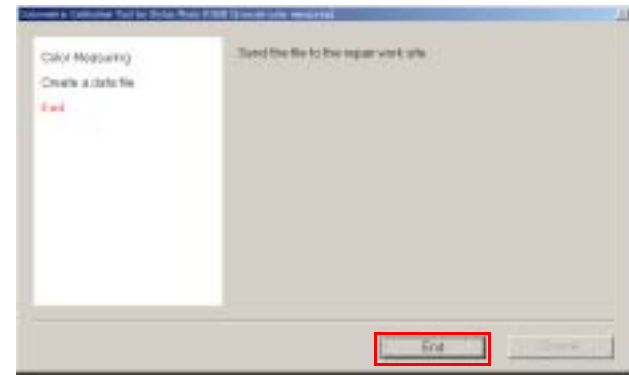

Figure 5-48. END

3. Repair work site

1. Start up the Colorimetric Calibration Tool for Stylus Photo R1800 on a PC, and click [Input the Color ID].

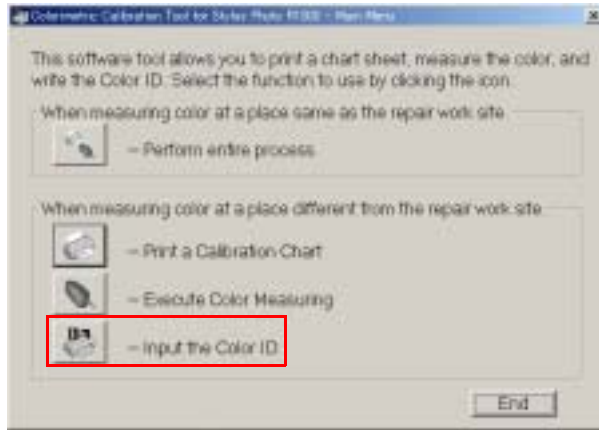

Figure 5-49. Entering the Color ID

The following shows the process when [Input the Color ID] is clicked.

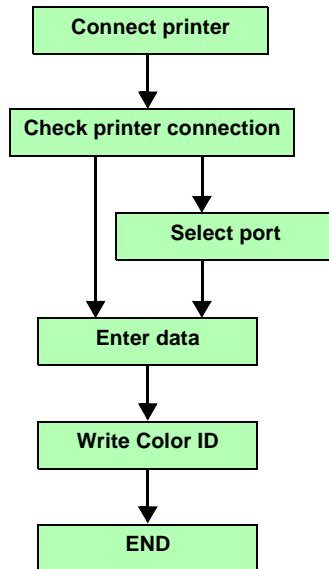

Figure 5-50. Entering the Color ID Workflow

2. Execute Step 2 ~ 3 of the procedure "When Measuring Color at a Place the Same as the Repair Work Site" (p150) to connect the printer to the PC.
3. Select either of "File" or "Manual input" in "Input method" box, and input the color measurement data.

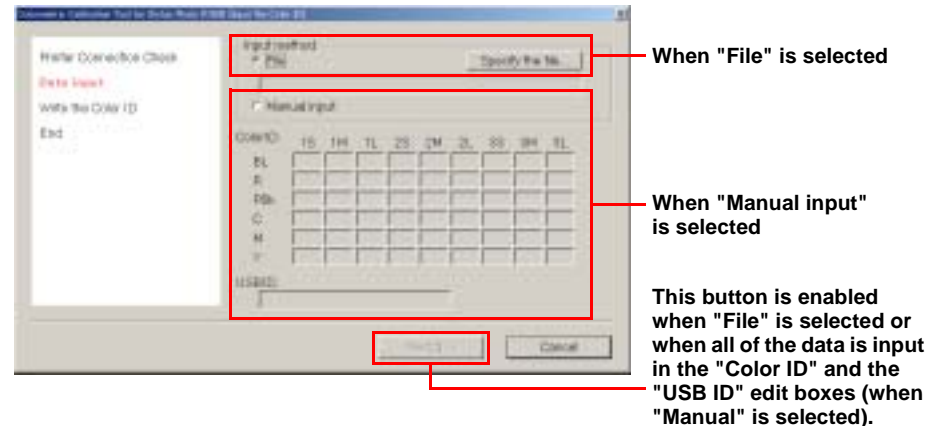
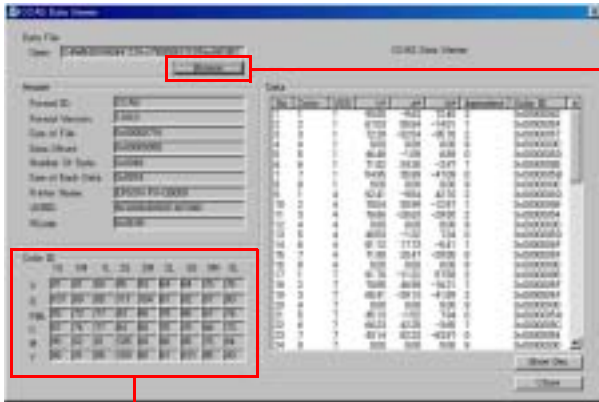

Figure 5-51. Entering Data

- When "File" is selected as Input method  
When "File" is selected as Input method, and the color measurement data file is selected, the content of the file is reflected in the "Color ID" and the "USB ID" edit boxes.
- When "Manual input" is selected as Input method  
Select "Manual input" at Input method, and directly enter the numerical values in the "Color ID" and the "USB ID" edit boxes. To enter numerical values, start up the correction value data file confirmation tool (CCAS Data Viewer), open the color measurement data file, check the Color ID at "Color ID" edit box and enter the numerical values.



Clicking the "Browse" button displays the file selection dialog box.

The Color ID is displayed in "Color ID" edit box after the color measurement data file is selected.

Figure 5-52. CCAS Data Viewer Screen

4. Make sure that the USB ID reflected (entered) at Step 3 matches the USB ID of the currently connected printer, then click [Next] to write the Color ID to the printer.



Figure 5-53. Write the Color ID



[Next] will not be enabled even if all of the data has been entered in the "Color ID" and "USB ID" edit boxes when selecting "File" as Input method but not specifying a file.



It takes about three minutes to write the Color ID.

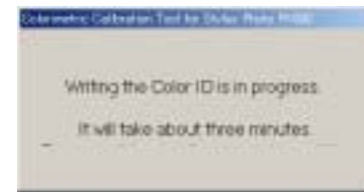

Figure 5-54. Writing the Color ID

- When the following screen is displayed, click [End], and turn the printer OFF then back ON again to end the adjustment. This action reflects the color measurement values on the printer.

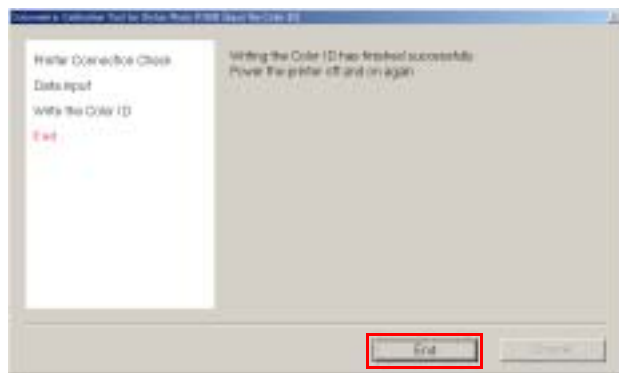

Figure 5-55. END

### 5.2.4.3 Error Messages

The following table lists the error and warning messages that are generated by the Colorimetric Calibration Tool

Table 5-7. List of Error Messages

Error	Message
Communication Error	Communication error. Check the connection status with the printer.
Timeout	Time-out error. Check the connection status with the printer.
Printer Driver not installed	The printer driver is not installed. Install the printer driver.
Printer not connected	The printer is not connected. Connect the printer and press [Retry] to check the printer connection again.
Ink Cartridge Low'	The remaining amount of the following ink(s) is low. Replace the corresponding ink cartridge(s) with a new one. XXXXX, XXXXX When installing a new cartridge(s), make sure to shake it (them) at least four times. A cleaning cycle will automatically start when a new cartridge(s) is installed. To stop the process, click [End].
Cleaning error	Error occurred while running the cleaning cycle. Check the printer status.
Automatic nozzle check failure	The automatic nozzle check has failed. There may be a problem with the print head.
Automatic nozzle check error	Error occurred while performing nozzle check. Check the printer status.
Ink mark sensor error	The automatic nozzle check has finished unsuccessfully. Click OK to start a nozzle check manually.
Color ID write error	Writing Color ID has failed. Check the printer status.
File save error	Saving the file has failed. Check if the disc has enough space, or if the folder is writable.
File open error	Reading the data file has failed. Check the date and size of the data file.
File format error	The file format is incorrect. Check if the correct file is selected.
Color ID parameter error	The parameters of the Color ID value are invalid.

Table 5-7. List of Error Messages

Error	Message
Preparing printer	The printer is not ready. Check the printer status.
Out of paper error	There is no paper loaded. Load a paper.
Paper jam error	A paper jam has occurred. Start from the printing again.
Print error	An error occurred while printing. Check the printer status.
Undefined file read error	Reading the required files has failed. Copy the program folder again.
Insufficient memory error	Insufficient memory. Exit all applications that are currently active.
Log file output error	Failed to output a log file. To continue the process, click [OK].
Calibrator plug-in read error	Failed to read the plug-in. Copy the program folder again.
Calibrator parameter error	A parameter error of the calibrator occurred. Check if the calibrator is Eye-One calibrator with a UV filter.
Calibrator communication error	Communication with the calibrator failed. Check the calibrator's connection status.
Calibrator calibration error (retry)	The calibration has failed. Put the Eye-One calibrator on the calibration plate and click [Retry] to recalibrate.
Calibrator calibration error (failed 3 times)	The calibration has failed. Check the calibrator status.
Color measurement failure	Color measuring of the Eye-One calibrator has failed. Measure colors of the failed row again.
Head ID read error	Failed to read the Head ID. Check the printer status.
Color ID mismatch error	The Color ID does not match the printer. Check the printer status.
Color ID enable flag invalid error	The Color ID enable flag has become invalid. Check the printer status.
Color ID read error	Failed to read the Color ID. Check the printer status.
Multiple data file error	There are multiple data files in the start-up folder. Copy the provided program folders again.
Unknown error	An error of unknown origin occurred.

Table 5-7. List of Error Messages

Error	Message
Printer offline	The printer is off-line. Place the printer online.
Ink Out Error	The remaining amount of the following ink(s) is low. Replace the corresponding ink cartridge(s) with a new one and retry this wizard. XXXXX, XXXXX

Table 5-8. List of Warning Messages

Error	Message
USB ID mismatch	The USB ID is different. The connected printer may be different from the one that printed the chart. Are you sure you want to continue?
Color measurement re-confirmation warning	There is a patch(s) that could not be measured properly. Perform the color measuring again.

## 5.2.5 Colorimetric Calibration by Users

### 5.2.5.1 Printing Calibration Chart by Users

The Colorimetric Calibration tool is available to the user. The user can print a Calibration Chart by himself/herself by using the tool.

Prepare the following tools for Colorimetric Calibration:

- EPSON Photo Paper (A4 or letter-size) :Used for printing a Calibration Chart
- Plain (standard) Paper (A4 or letter-size) :Used for printing a nozzle check pattern
- Clear file :for mailing to our service center
- Plain paper (A4 or letter-size) :for mailing to our service center

The procedure for printing the Calibration Chart for users is given on the following pages.



## Calibration Chart Print Procedure for Users

OS : Windows XP/Me/2000/98  
: MacOS X 10.2x, 10.3x, MacOS 9.x

Port : USB1.1  
: USB2.0  
: IEEE1394

### □ Input Method

1. Copy the complete set of related files to any one folder.
2. Double click "CCASSPR1800Print.exe" (Windows) or "CCASSPR1800Print" (Macintosh) to start up the program on the computer.
3. Connect the printer to the PC using a USB or IEEE cable, and click "Next".

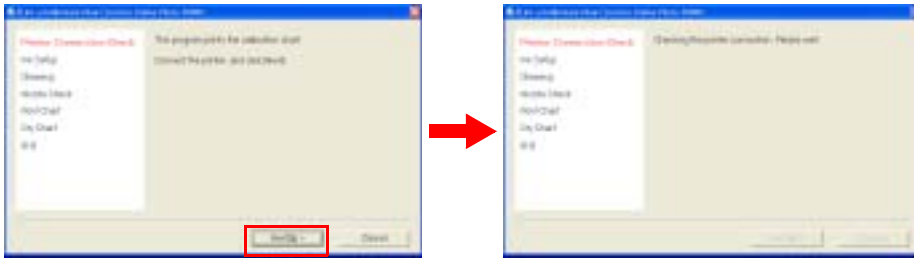

Step3.Printer Connection Check Screen

CHECK  
POINT



- When two or more printers are currently connected, the screen changes to the "port selection" screen. Select the target printer, and click [Next].

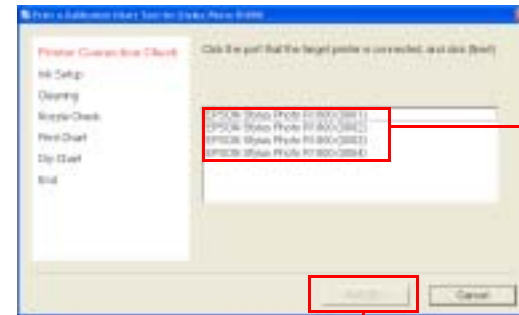

Select a target  
printer.

The button is  
enabled when the  
printer is selected.

Port Selection Screen

- To prevent inks from settling down at the bottom, remove all ink cartridges, shake them at least four times, and reinstall them to the printer. The printer will automatically run a replacement cleaning cycle.

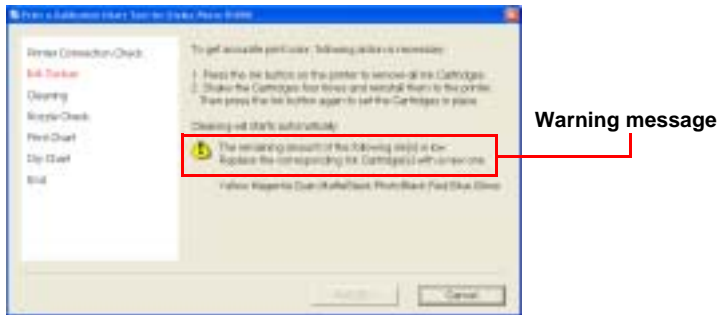

**Step4.Ink Setup**



**If a warning message appears on the LCD saying that ink level is low, replace the indicated ink cartridge(s) with a new one.**

- Wait for the cleaning to finish. It will take about two minutes.

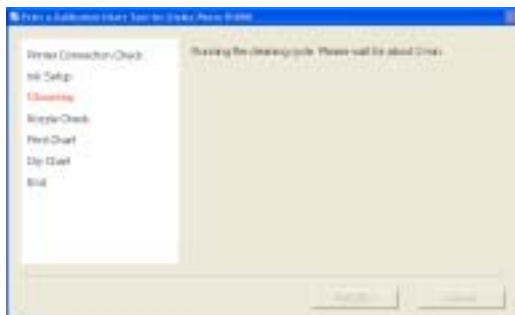

**Step5.Cleaning**

- Load one sheet of A4 or letter-size plain paper, and click "Next" to execute the automatic nozzle check.

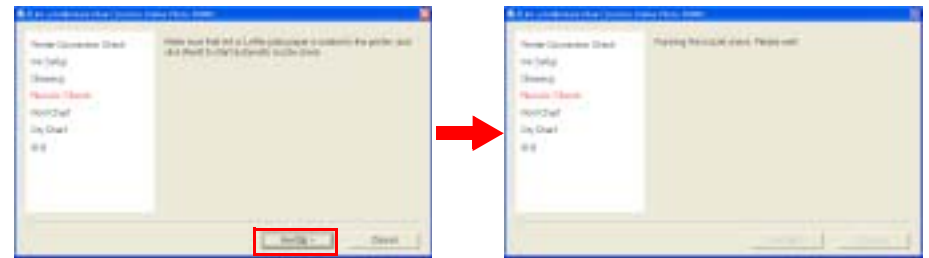

**Step6.Automatic Nozzle Check**

- Load one sheet of A4 or letter-size Photo paper, and click "Next" to print the Calibration Chart.

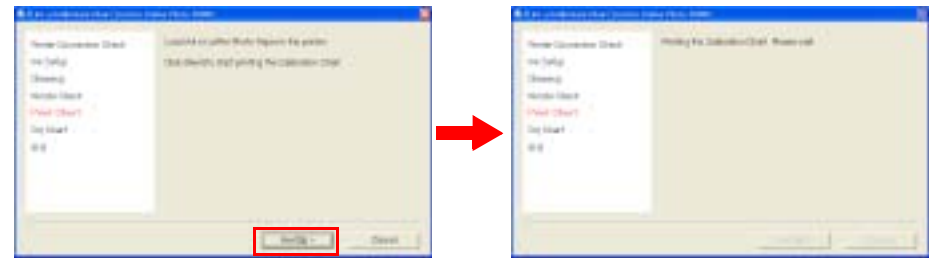

**Step7.Printing a Calibration Chart**



**The recommended air temperature range for printing a Calibration Chart is 15°C to 28°C.**

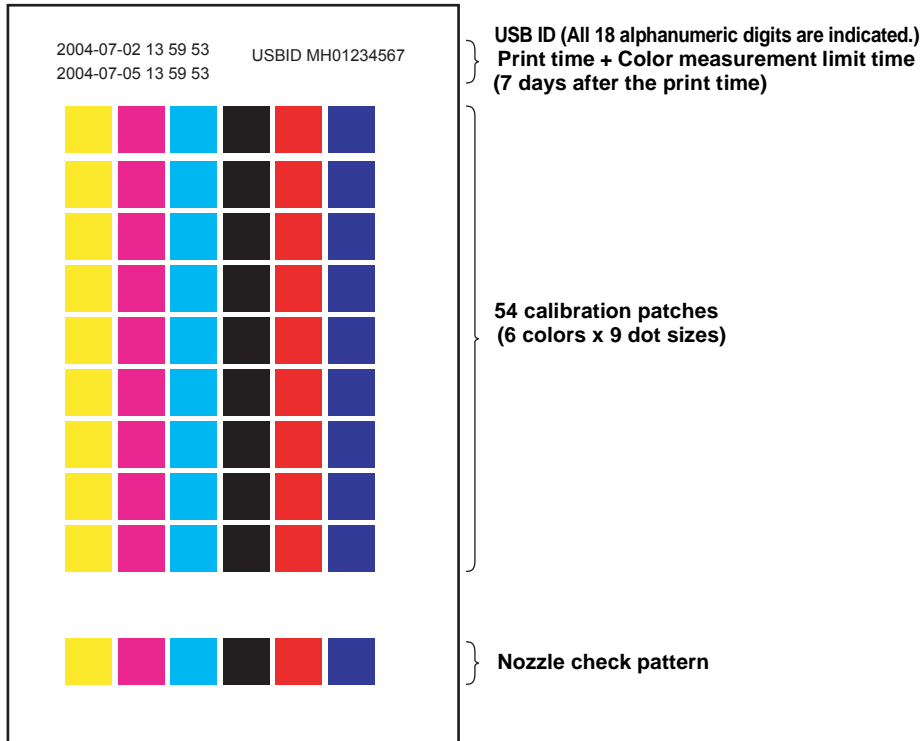
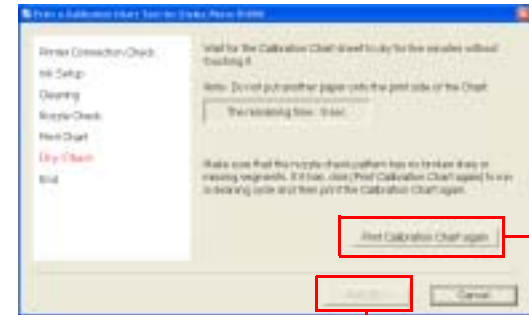

Illustration of Calibration Chart

- After the Calibration Chart is printed, allow it to dry for five minutes. During this time, check the nozzle check pattern on the chart. If there are broken lines or missing segments, click [Print Calibration Chart again], and return to [Step 5](#). If there are no broken lines or missing segments, click [Next].



When there are broken lines or missing segments

This button is enabled when countdown is completed.

### Step8.Drying the Chart



- There is no need to print a Calibration Chart again, even if you find broken lines or missing segments in Gloss Optimizer the nozzle check pattern.
- Do not touch the printed chart sheet until it dries.To do so may cause the printed color to change.

- Mail the Calibration Chart sheet to our service center within two days after printing it.  
To mail the Chart, make sure to put it into a clear file and enclose a sheet of plain paper to protect the print side.

### 5.2.5.2 Writing of Color ID by Users

When servicing, there may be a case that the printer is returned to the user after printing/measuring a chart for the Colorimetric Calibration and performing the Head ID adjustment, without writing the Color ID at the repair work site. In such case, the user required to write the Color ID to the printer by him/herself using the color measuring data sent from the service site.

The following two files will be sent to the user. The user can reflect the color measurement values on the printer by executing the EXE file in the same directory as the color measurement data.

- "CCASSPR1800Write.exe" (Windows) or "CCASSPR1800Write" (Macintosh)(exec file for writing Color ID)  
The exec file for writing Color IDs is exclusively for the user, and is different from the exec file (CCASStylusR1800.exe) for service personnel.
- xxxxxxxx.dat (color measurement data file)  
The color measurement data file is the same as the file for service personnel and is supplied from the color measurement site.

#### CAUTION



- **When the startup folder contains two or more color measurement data files, the following error message is displayed and the program is exited:**
  - "Failed to read the Color ID. Check the printer status."

#### CHECK POINT



**The exec file automatically reads the color measurement data files in the same directory to prevent the user from being aware of the file name of the color measurement data.**

- Reflection of correction according to Head ID  
Every mass-produced printer is calibrated by the Colorimetric Calibration at the factory.  
To reflect color correction by the Head ID, reinput the Head ID using the adjustment program. This means that the Head ID will be continuously reflected until the Color ID is input.

The procedure for writing the Color ID for users is given on the following pages.

## Color Correction Value Entry Procedure

OS : Windows XP/Me/2000/98  
: MacOS X 10.2x, 10.3x, MacOS 9.x

Port : USB1.1  
: USB2.0  
: IEEE1394

□ Input method

1. Copy the complete set of related files to any one folder.
2. Double click "CCASSPR1800Write.exe" (Windows) or "CCASSPR1800Write" (Macintosh) to start up the program on the computer.
3. Connect the printer to the PC using a USB or IEEE cable, and click "Next".

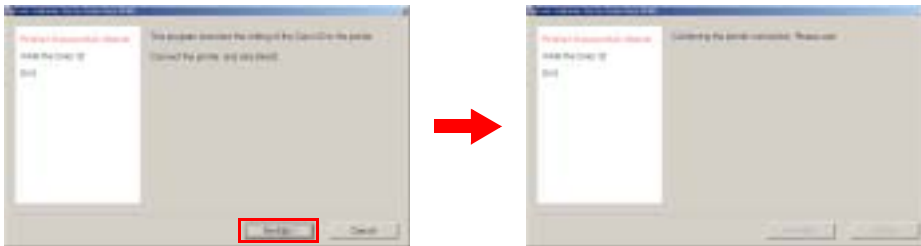

Step3.Printer Connection Check Screen

CHECK  
POINT



- When two or more printers are currently connected, the screen changes to the "port selection" screen. Select the target printer, and click [Next].

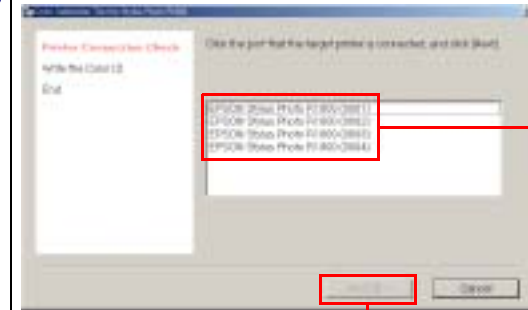

Select a target  
printer.

The button is  
enabled when the  
printer is selected.

Port Selection Screen

4. Clicking "Next" writes the color correction values automatically to the printer.



**Step4.Color Correction Value Write Screen**

5. When the following screen is displayed, click "End" and turn the printer OFF then back ON again to end the adjustment.



**Step5.End Screen**



**It takes about three minutes to write the color correction values. Do not turn off both the computer and the printer, or do not kill the connection between them during the writing is in progress.**



**Writing the Color ID**

6. Turn the printer OFF.



CHAPTER

6

# MAINTENANCE

## 6.1 Overview

This section provides information to maintain the printer in its optimum condition.

### 6.1.1 ROM Replacement

This printer may require the ROM to be replaced when the program is changed or added. In such cases, use the special tool (ROM puller: 2035659 (#F749)) to replace the ROM. The position of the ROM is shown in the figure below.

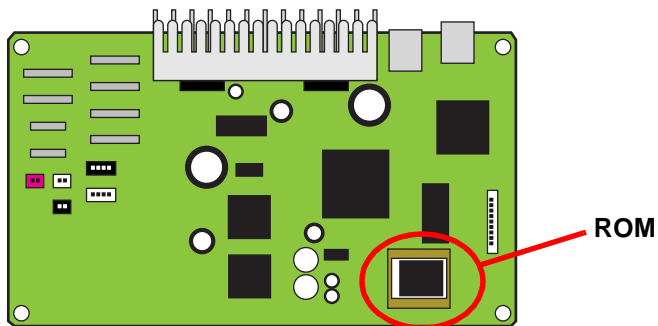

C589 Main Board

Figure 6-1. ROM Location

### 6.1.2 Cleaning

This printer has no mechanical components which require regular cleaning. Therefore, when returning the printer to the user, check the following parts and perform appropriate cleaning if stain is noticeable.

#### CAUTION



- Never use chemical solvents, such as thinner, benzene, and acetone, to clean the exterior parts of the printer like the housing. These chemicals may degrade or deteriorate the quality of this product.
- Be careful not to damage any components when you clean inside the printer.
- Do not scratch the surface of the PF Roller assembly. Use a soft brush to wipe off dust.
- Use a soft cloth moistened with dilute alcohol to remove ink stain.
- Do not use the supplied cleaning sheet for normal usage. It may damage the coated surface of the PF Roller. If the adhesive surface of the cleaning sheet is set to the ASF LD Roller side and used to clean the ASF LD Roller surface, it is no problem.

- Housing  
Use a clean soft cloth moistened with water and wipe off any dirt. If the Housings are stained with ink, use a cloth moistened with neutral detergent to wipe it off.
- Inside the printer  
Use a vacuum cleaner to remove any paper dust.

## 6.1.3 Service Maintenance

If print irregularity (missing dot, white line, etc.) has occurred or the printer indicates "Maintenance Error", take the following actions to clear the error.

### 6.1.3.1 Head Cleaning

The printer has a built-in head cleaning function, which is activated by operating the control panel. The procedure is given below.

1. Confirm that the printer is in stand-by state.  
Check that the Power LED is not flashing.
2. Hold down the Ink Switch on the control panel for more than 3 seconds.  
The Power LED flashes during the cleaning sequence.

CHECK  
POINT



**For Head Cleaning, it is recommended to run the nozzle check and the cleaning alternately to minimize ink consumption.**

### 6.1.3.2 Maintenance Request

Ink is used for printing and Head Cleaning. Waste ink is drained into the Waste Ink Pads via the Cap Unit, and its amount is stored into the EEPROM's Protection Counters (Waste Ink Counter) A and B (located near the home position or the opposite side). When the preset value is reached, the Waste Ink Counters detect that the Waste Ink Pads have reached the absorption limit. The printer displays "Maintenance Request" to request the Waste Ink Pads to be replaced.

- Protection Counter A+B Limit
  - Up to 17772
- Timing for Replacing the Waste Ink Pads
  - When the Protection Counter reaches the value shown above, a Maintenance Request is indicated, and the printer disables all switches except the Power switch.
  - Since the Protection Counter value can be confirmed in the adjustment program, be sure to check the value when servicing regardless of whether the service is related to the Waste Ink Pad or not. If the Protection Counter value of that printer is close to its limit, inform the user about that, and replace the Waste Ink Pads and reset the Counters with the user's permission. (If the Waste Ink Pads are not replaced at that time, it is expected that the printer will be returned for repair in the near future due to a Maintenance Request error.)
  - Under the specific conditions, the limit level of the counter is preset to 25000 pages for black ink or to 10000 pages for color ink. We assume that the limit level will be reached in about 3 years in normal use.
- Replacement Procedure  
Replacement of Waste Ink Pads in Disassembly and Assembly  
(Refer to 4.2.2 "Waste Ink Pad" on page 80.)
- After the Replacement  
Reset the Protection Counter (Refer to Chapter 5 "ADJUSTMENT")

### 6.1.4 Lubrication

The lubrication used for the components of the printer has been decided on based on evaluation carried out by Epson. Therefore, the specified amount and places of lubrication given in this section should be strictly observed.



- Never use oil or grease other than those specified in this manual. Use of different types of oil or grease may damage the components or affect the printer functions.
- Never apply a larger amount of oil or grease than specified in this manual.

Table 6-1. Grease Applied to the Stylus Photo R800

Type	Name	EPSON CODE	Supplier
Grease	G-26	1080614	EPSON
Grease	G-45	1033657	EPSON
Grease	G-71	1304682	EPSON

<Lubrication Point>  
Left and Right Adjust Parallel Bushings (outer circumference)

<Lubrication Type>  
G-26

<Lubrication Amount>  
φ1mm x 2mm

<Remarks>

- Apply with a syringe. (Pin Head: φ1mm)
- After lubrication, install and turn the PG Cam Bush to spread the grease evenly.

Figure 6-2. Lubrication (1)

<Lubrication Point>  
Contact point of the CR Scale Mounting Plate (Left/Right) and the Main Frame

<Lubrication Type>  
G-26

<Lubrication Amount>  
Apply evenly.

<Remarks>  
Apply with a brush.

Figure 6-3. Lubrication (2)

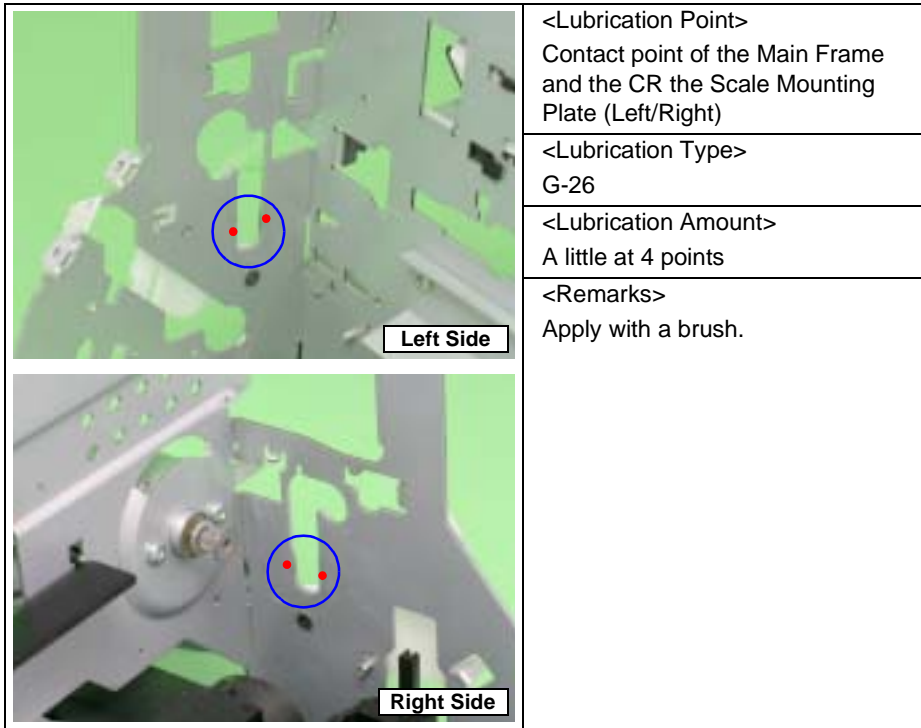

Figure 6-4. Lubrication (3)

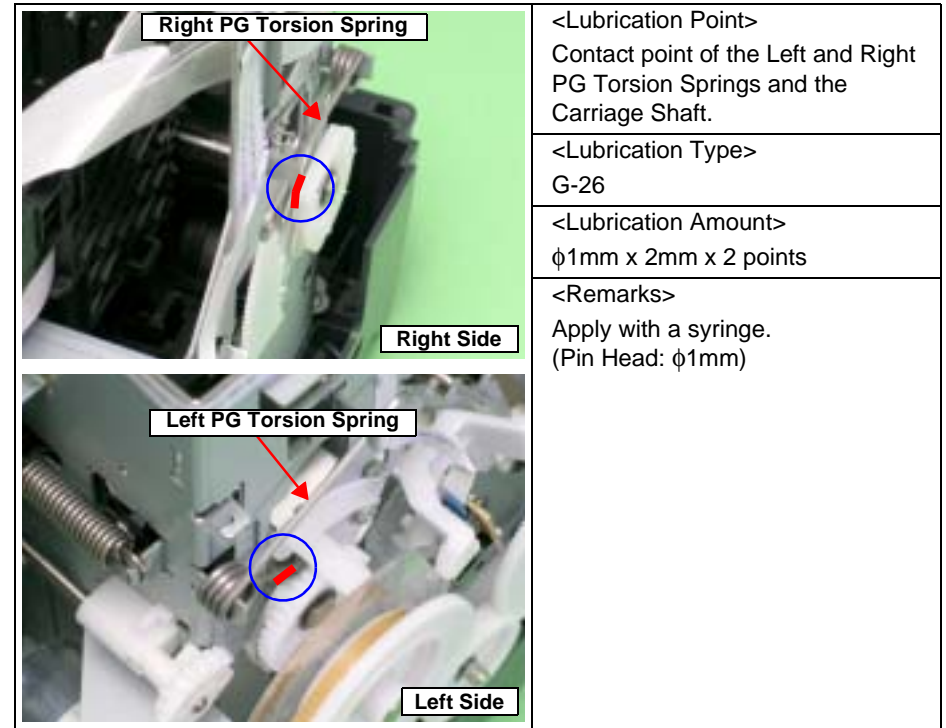

Figure 6-6. Lubrication (5)

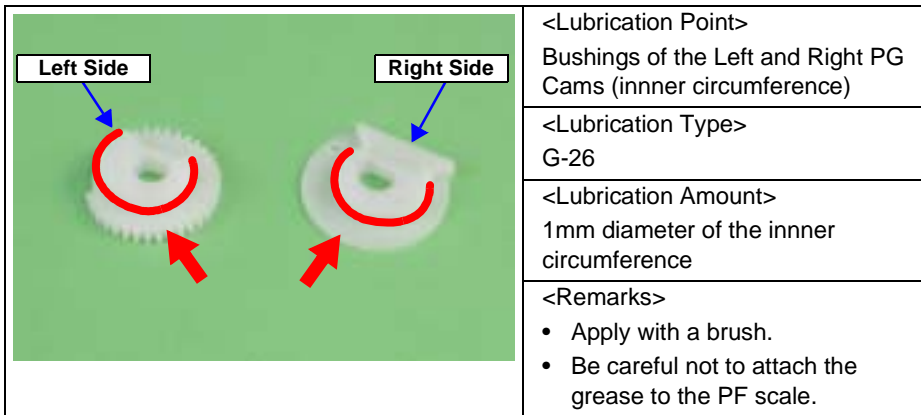

Figure 6-5. Lubrication (4)

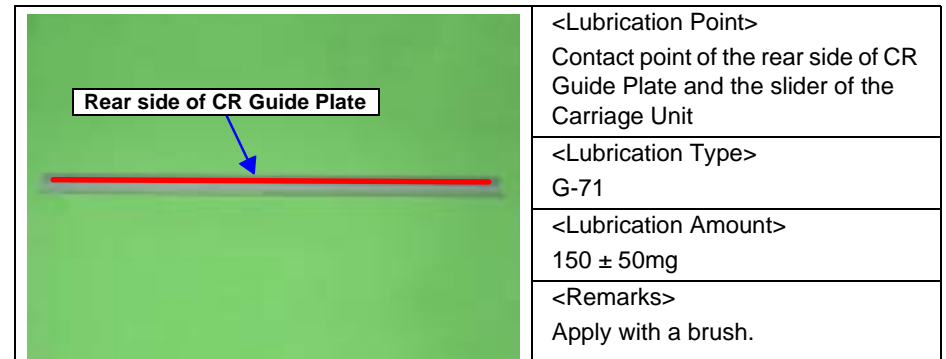

Figure 6-7. Lubrication (6)

	<Lubrication Point> The Driven Pulley Holder
	<Lubrication Type> G-26
	<Lubrication Amount> φ1mm x 2mm x 4 points
	<Remarks> Apply with a syringe. (Pin Head: φ1mm)

Figure 6-8. Lubrication (7)

	<Lubrication Point> Contact point of the Driven Release FLAG and the Upper Paper Guide
	<Lubrication Type> G-26
	<Lubrication Amount> φ1mm x 5mm x 6 points
	<Remarks> Apply with a syringe. (Pin Head: φ1mm)

Figure 6-9. Lubrication (8)

	<Lubrication Point> Contact point of the EJ Grounding Spring and Front and Rear Paper EJ Rollers
	<Lubrication Type> G-45
	<Lubrication Amount> φ1mm x 2mm x 2 points
	<Remarks> Apply with a syringe. (Pin Head: φ1mm)

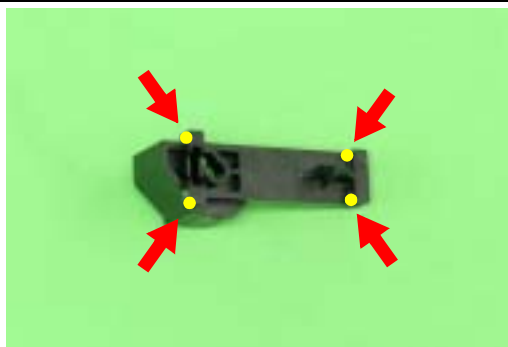
Figure 6-10. Lubrication (9)

	<Lubrication Point> The bushing of the Front Paper Guide
	<Lubrication Type> G-45
	<Lubrication Amount> 1. Apply evenly. 2. φ1mm x 2mm
	<Remarks> Apply with a brush.

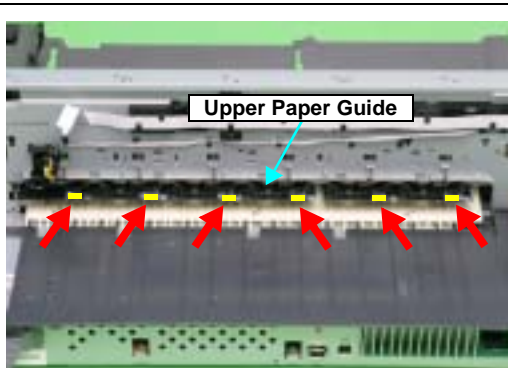
Figure 6-11. Lubrication (10)

	<Lubrication Point> 1. Left side of the PF Roller Shaft (Left of the E-Ring) 2. Mounting location of the Bushing 8
	<Lubrication Type> G-45
	<Lubrication Amount> 1. Approx. φ1mm x 5mm 2. All around the Shaft
	<Remarks> 1. Apply with a syringe. 2. Apply with a brush.

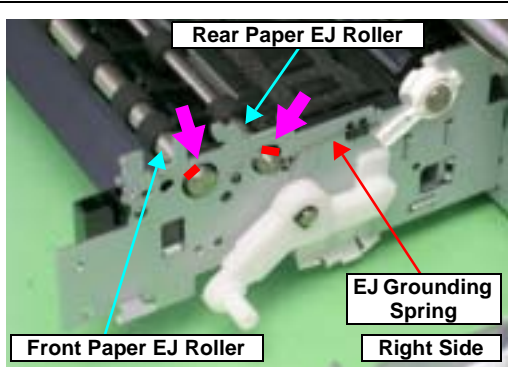
Figure 6-12. Lubrication (11)



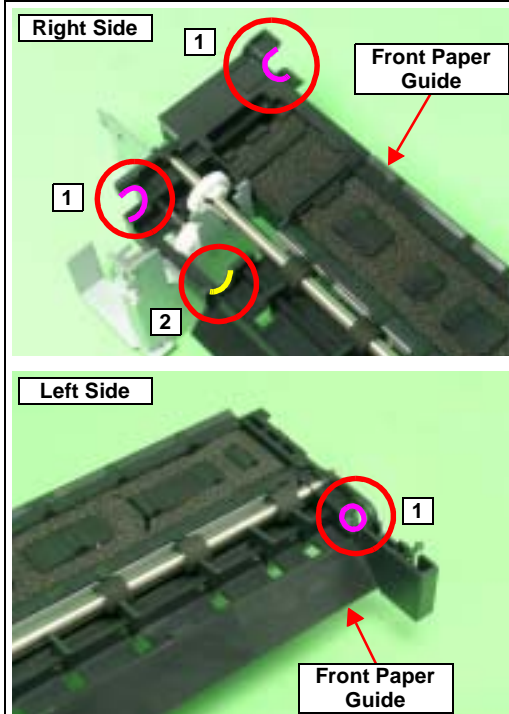

<Lubrication Point>
1. Contact point of the Rear Paper Guide and the PF Roller
2. Contact point of the PF Grounding Spring and the PF Roller
<Lubrication Type>
G-45
<Lubrication Amount>
1. Apply evenly.
2. $\phi 1\text{mm} \times 2\text{mm}$
<Remarks>
1. Apply with a brush.
2. Apply with a syringe. (Pin Head: $\phi 1\text{mm}$ )

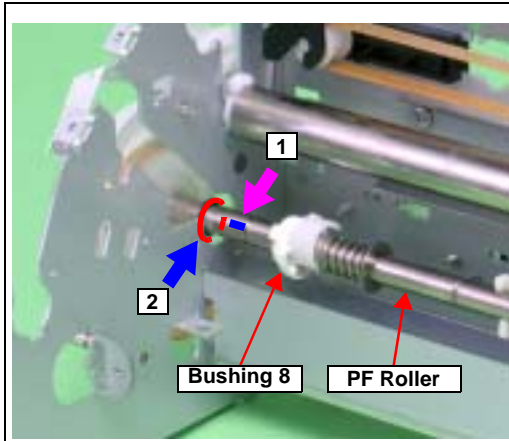
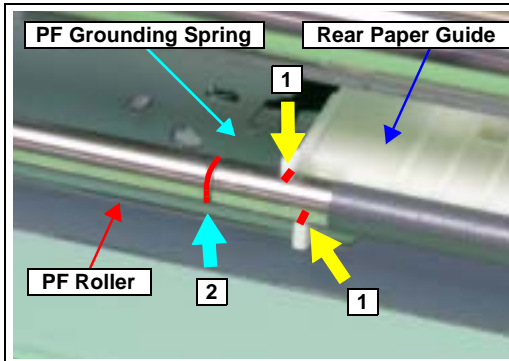
Figure 6-13. Lubrication (12)

### 6.1.4.1 Lubrication of Carriage Shaft

1. Fit the Carriage Unit onto the Carriage Shaft, and move it to the center of the Shaft.



**In the following step, do not bring the needle of a syringe into contact with the Carriage Shaft.**

2. Using a syringe, lubricate the holes (2 places) at both ends of the Carriage Unit rear side with grease.

Lubrication Type	Lubrication Amount
G-71	280mg x 2 points

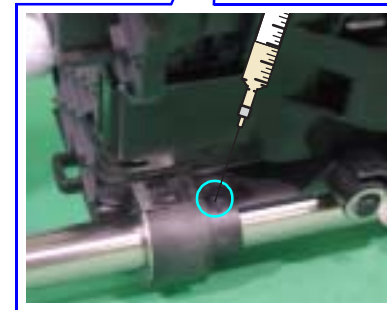
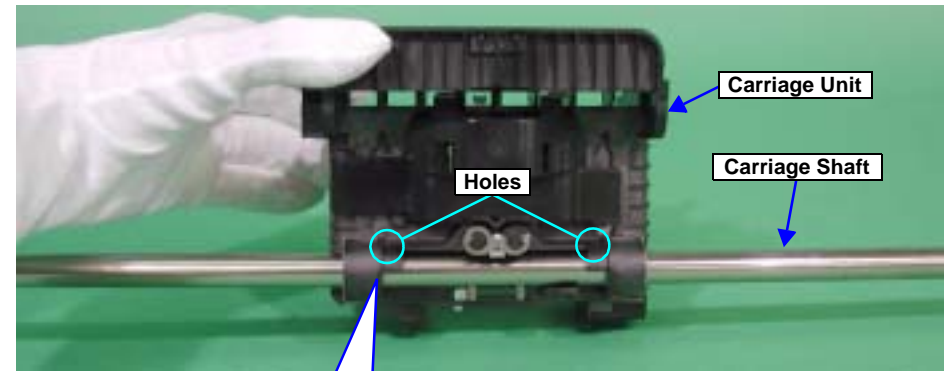

Figure 6-14. Lubricating the Carriage Shaft (1)



3. Hold the Carriage Unit, and while turning the Carriage Shaft clockwise and counterclockwise, move the Carriage Unit to spread the grease evenly.

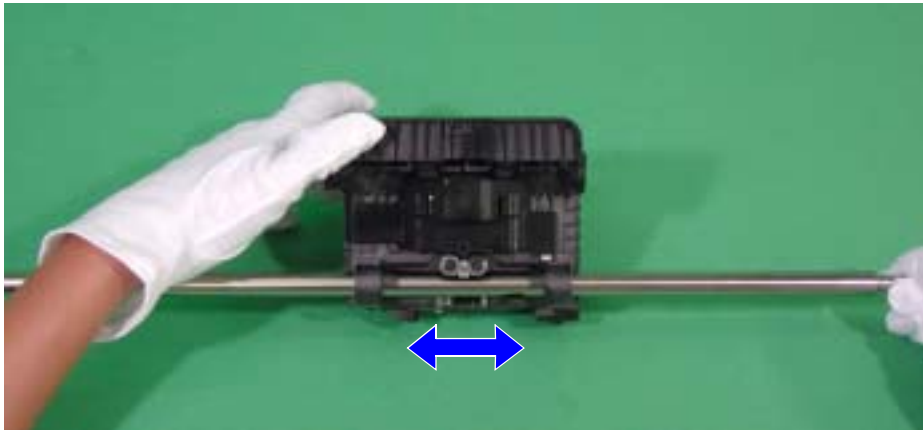

Figure 6-15. Lubricating the Carriage Shaft (2)

4. Move the Carriage Unit to the right end of the Carriage Shaft viewing the Unit from the rear, and lubricate grease with the syringe at the point shown in Figure 6-16.

Lubrication Type	Lubrication Amount
G-71	140mg

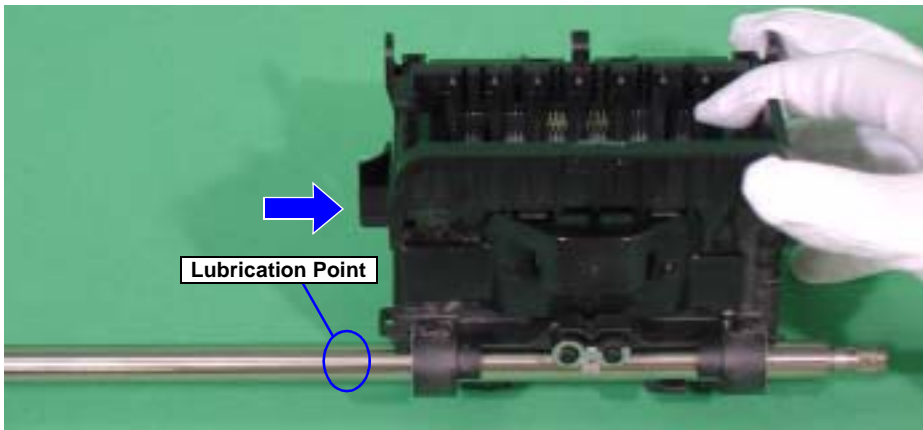

Figure 6-16. Lubricating the Carriage Shaft (3)

5. Hold the Carriage Unit, and while turning the Carriage Shaft, move the Carriage Unit to the left end of the Carriage Shaft to lubricate the grease evenly.
6. Lubricate grease with the syringe at the point shown in Figure 6-17.

Lubrication Type	Lubrication Amount
G-71	140mg

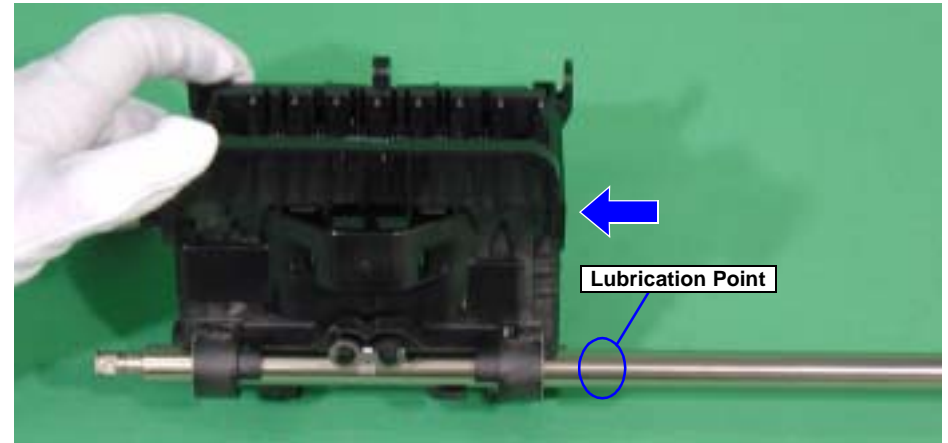

Figure 6-17. Lubricating the Carriage Shaft (4)

7. Hold the Carriage Unit, and while turning the Carriage Shaft, move the Carriage Unit to the right end of the Carriage Shaft to lubricate the grease evenly.



Figure 6-18. Lubricating the Carriage Shaft (5)

8. Repeat [Step 4 ~ 7](#).

CHAPTER

7

**APPENDIX**

## 7.1 Connector Summary

This section shows the connections between the main components of the printer.

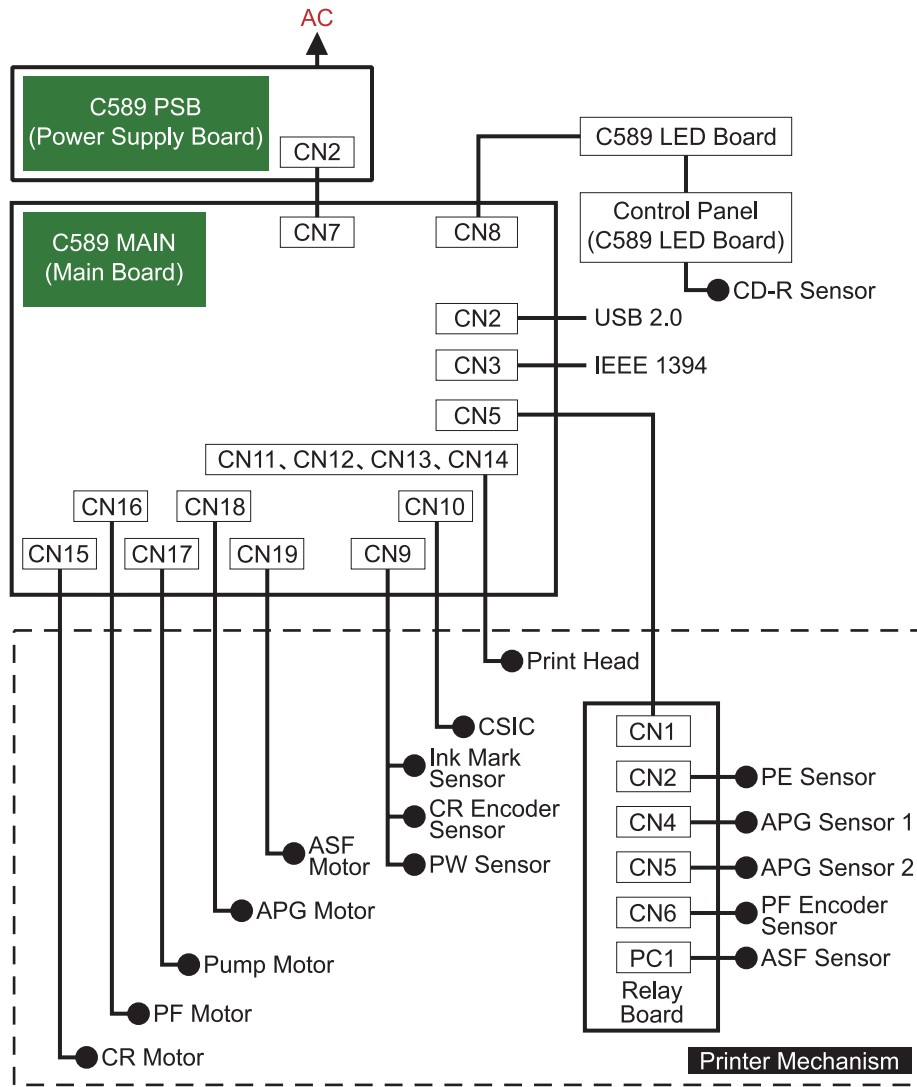

Table 7-1. Connection of the Major Components

### 7.1.1 Connectors and Pin Layouts

See the following tables for the connector summary for the C589 MAIN Board and each connector's pin alignment.

Table 7-1. Connector Summary for C589 MAIN

Connector	Function
CN5	Sensor 1 (PE Sensor, APG Sensor, PF Encoder Sensor, ASF Sensor)
CN7	Power Supply
CN8	LED Board
CN9	Sensor 2 (Ink Mark Sensor, CR Encoder Sensor, PW Sensor)
CN10	CSIC
CN11	Print Head 1-2 (including head temperature)
CN12	Print Head 1-1
CN13	Print Head 2-2
CN14	Print Head 2-1 (including thermistor)
CN15	CR Motor
CN16	PF Motor
CN17	Pump Motor
CN18	APG Motor
CN19	ASF Motor

## 7.2 Exploded Diagram

---

Following pages show exploded diagram.

- Exploded Diagram 1
- Exploded Diagram 2
- Exploded Diagram 3
- Exploded Diagram 4
- Exploded Diagram 5
- Exploded Diagram 6

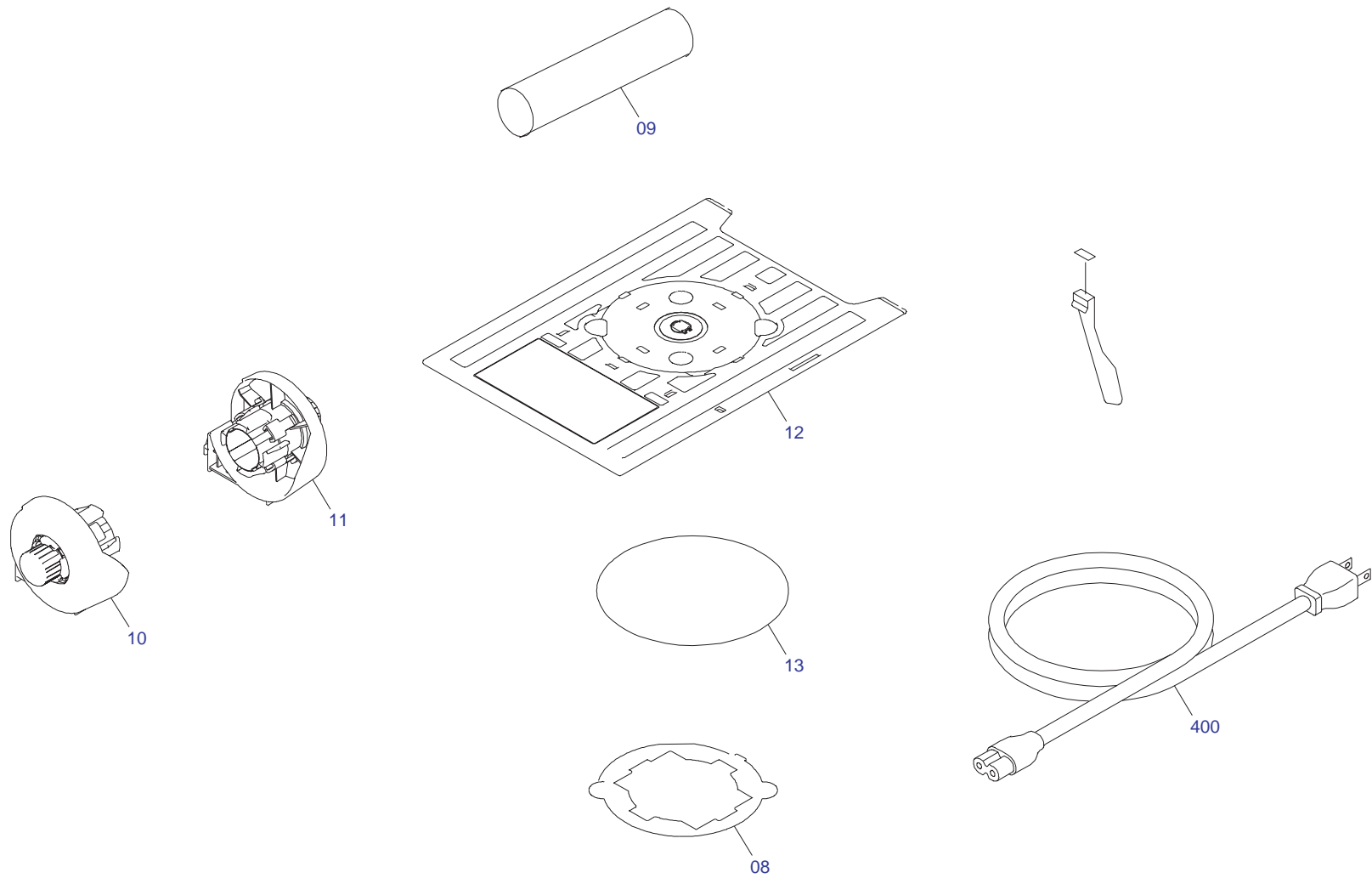

PX-G5000/EPSON STYLUS PHOTO R1800 No.1

Rev.01 C589-ACCE-011E

Figure 7-2. Stylus Photo R1800 Exploded Diagram 1

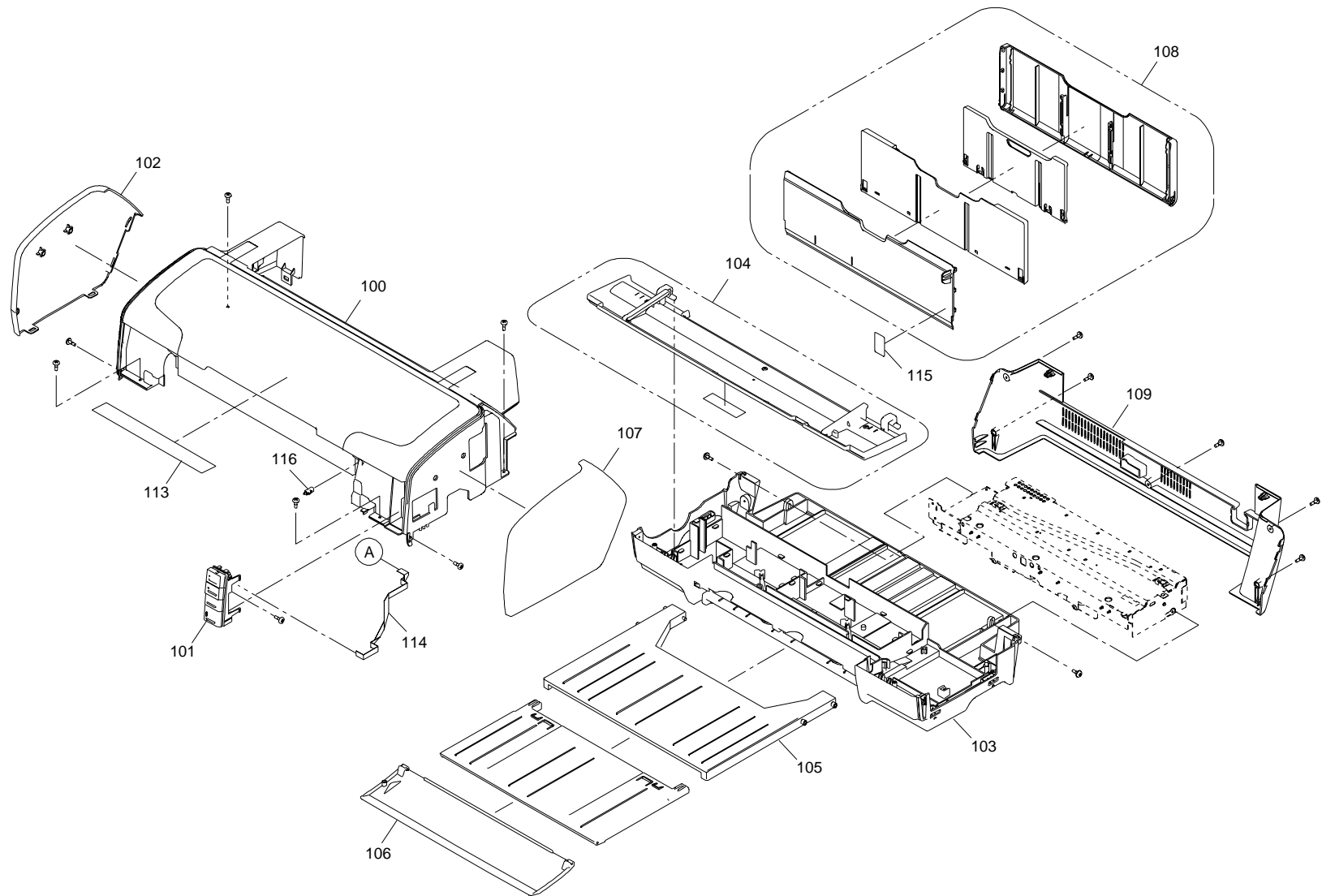

PX-G5000 / EPSON STYLUS PHOTO R1800 No.2 Rev.01 C589-CASE-011

Figure 7-3. Stylus Photo R1800 Exploded Diagram 2



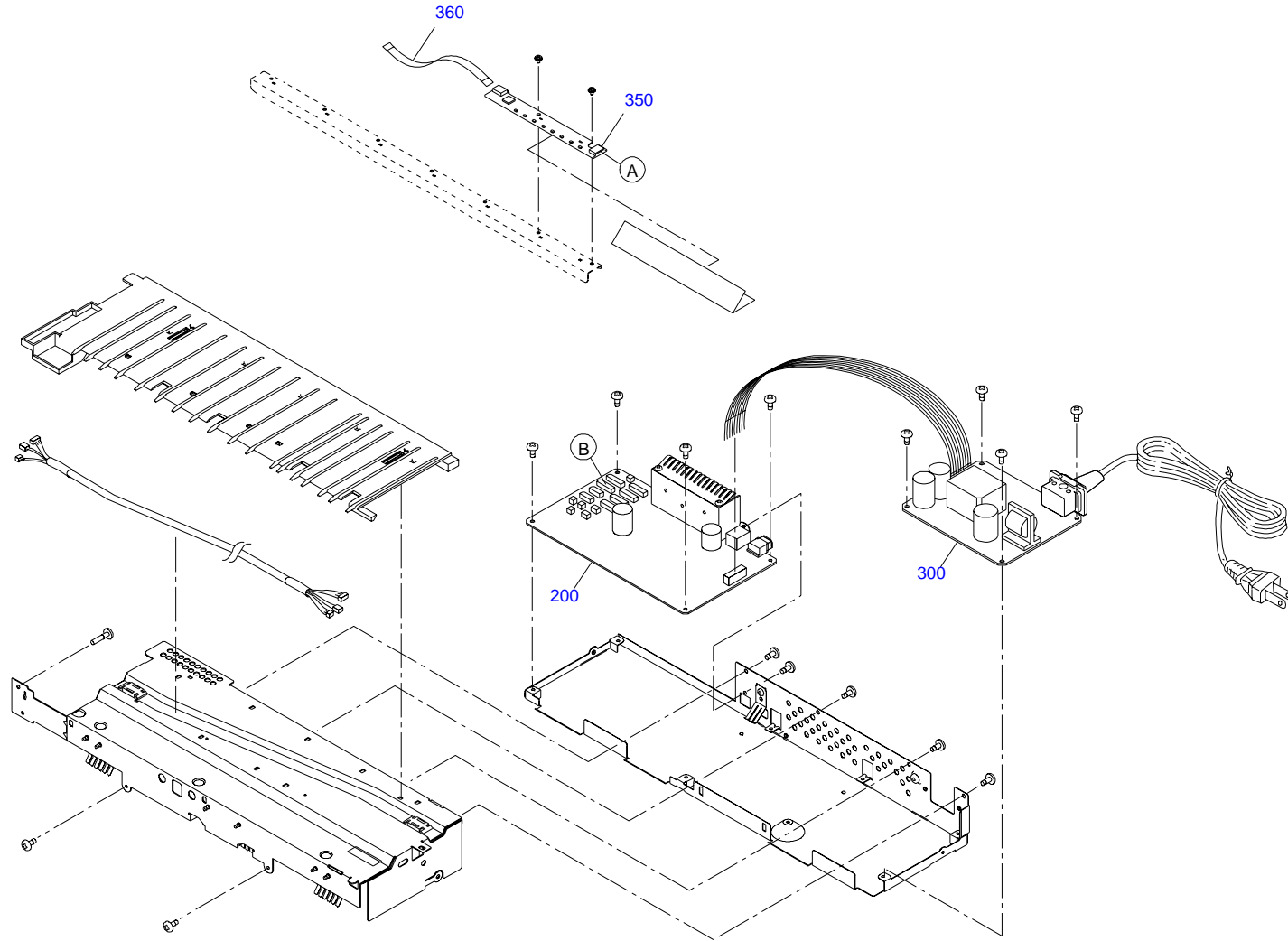

PX-G5000 / EPSON STYLUS PHOTO R1800 No.3 Rev.01 C589-ELEC-011

Figure 7-4. Stylus Photo R1800 Exploded Diagram 3

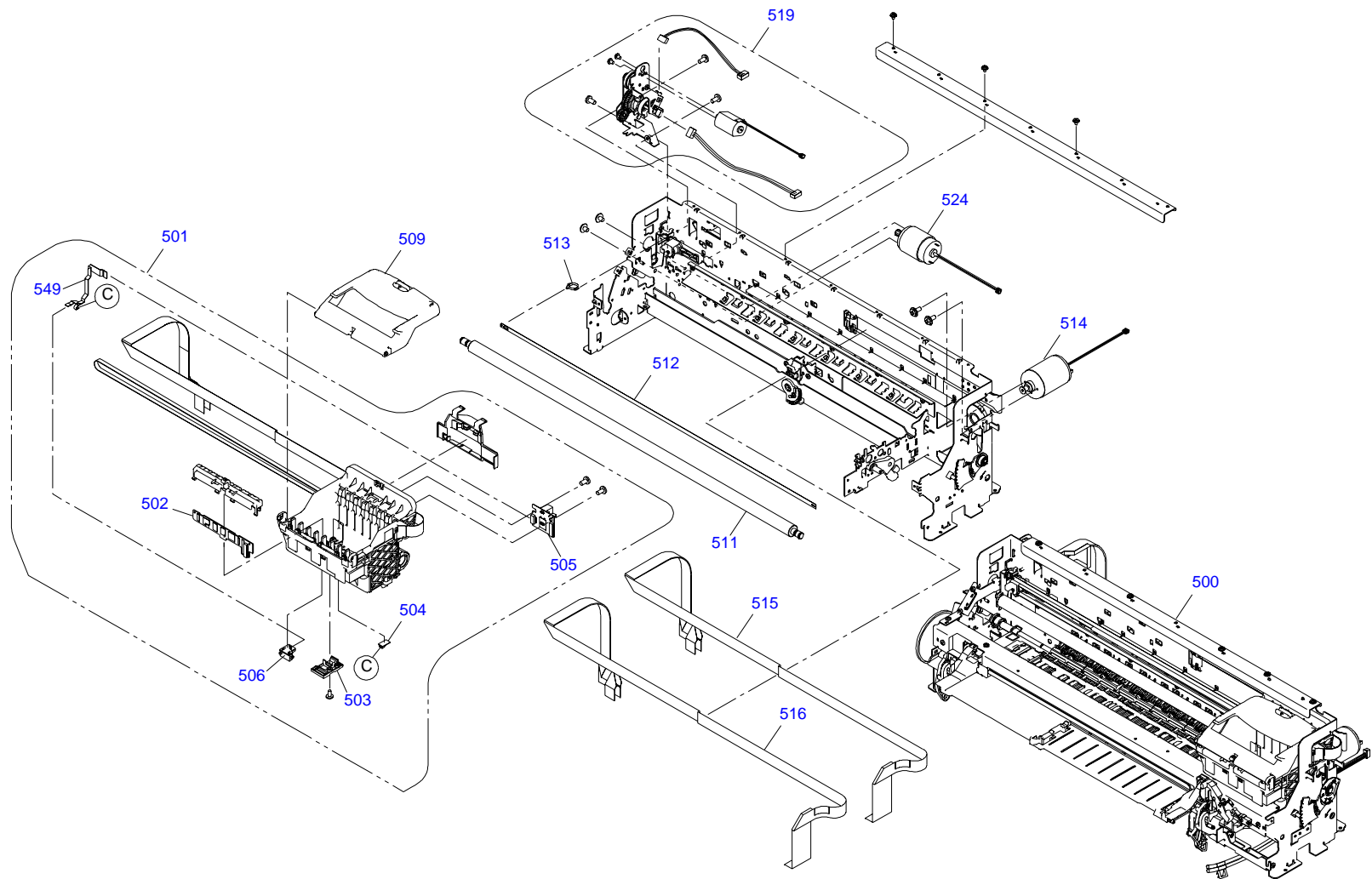

PX-G5000 / EPSON STYLUS PHOTO R1800 No.4

Rev.01 C589-MECH-011

Figure 7-5. Stylus Photo R1800 Exploded Diagram 4

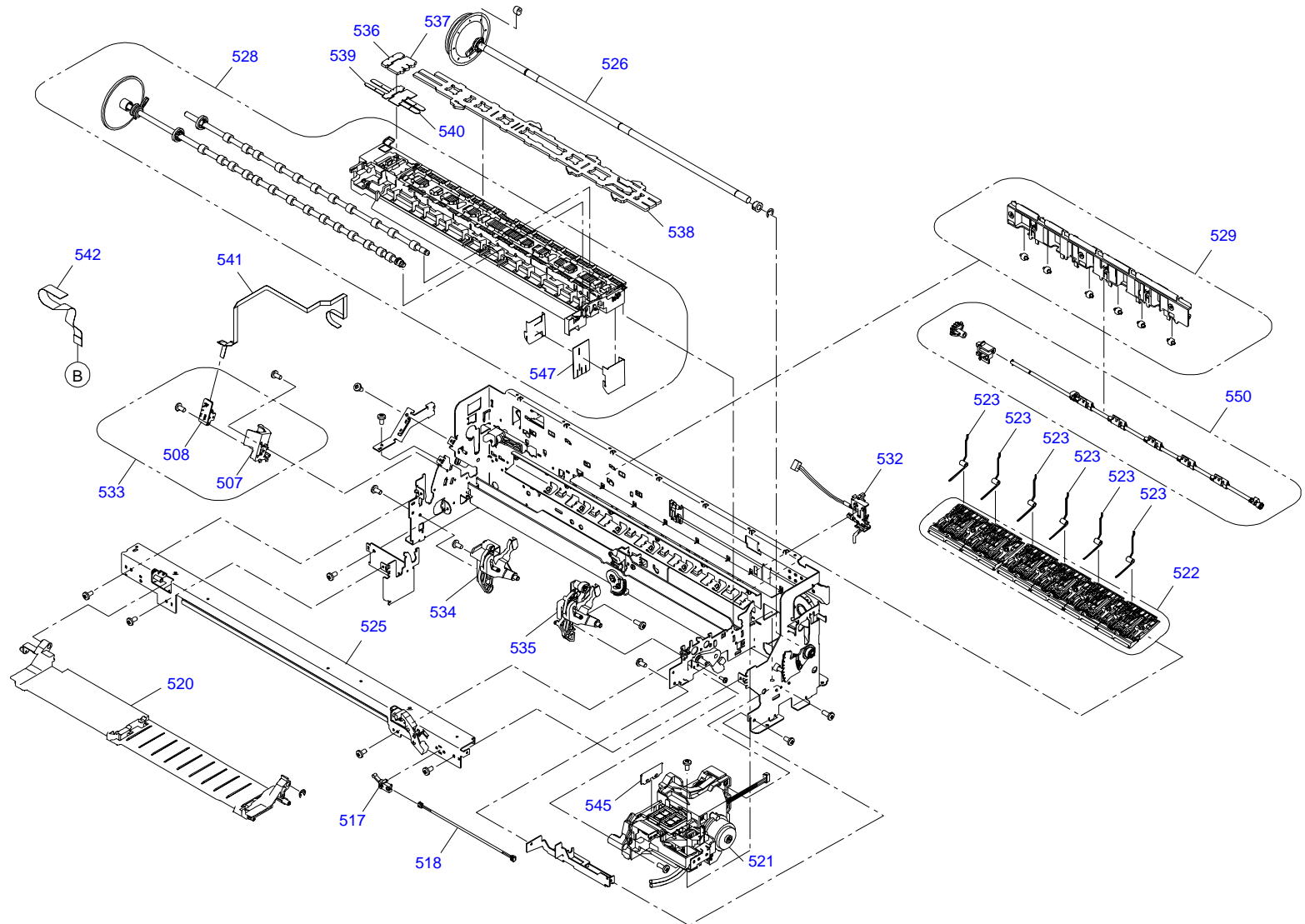

PX-G5000 / EPSON STYLUS PHOTO R1800 No.5

Rev.01 C589-MECH-021

Figure 7-6. Stylus Photo R1800 Exploded Diagram 5

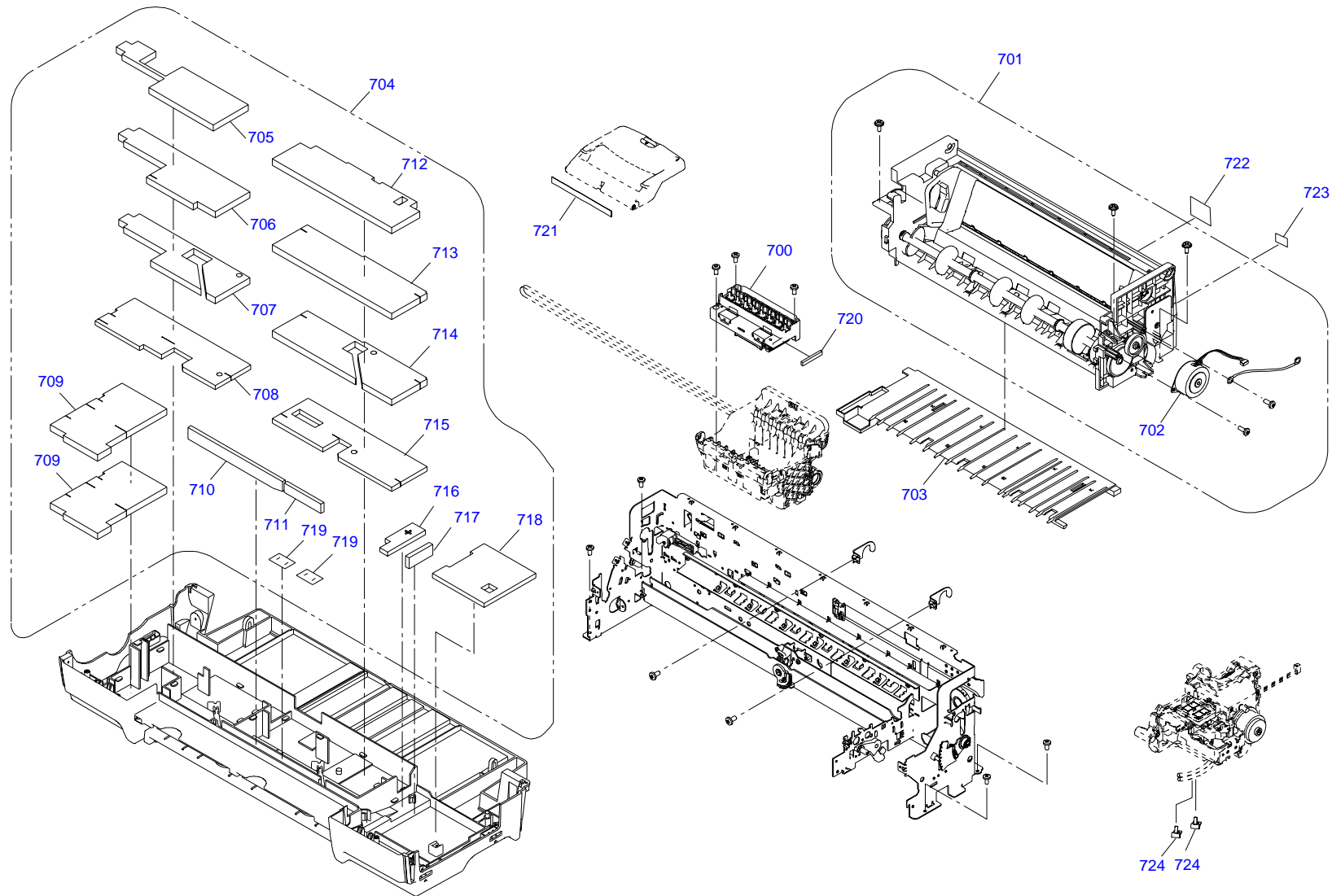

PX-G5000 / EPSON STYLUS PHOTO R1800 No.6

Rev.01 C589-MECH-031

Figure 7-7. Stylus Photo R1800 Exploded Diagram 6

## 7.3 Parts List for EPSON Stylus Photo R1800

Table 7-2. Parts List for EPSON Stylus Photo R1800

Code	Parts Name
8	ADAPTER,CDR
10	ROLL PAPER ASSY.,LEFT;B,ASP
11	ROLL PAPER ASSY.,RIGHT;B,ASP
12	TRAY,CDR
13	SHEET,CD,DUMMY
16	MATTE PAPER SUPPORT ASSY.,ASP
17	PAPER SUPPORT USFAP ASSY.,ASP
100	HOUSING UPPER ASSY.;B,ASP
101	PANEL ASSY.,ASP
102	COVER,LEFT
103	HOUSING,LOWER ASSY.,ASP
104	HOUSING CD-R ASSY.;B,ASP
105	STACKER
106	COVER,STACKER
107	COVER,RIGHT
108	PAPER SUPPORT ASSY.;B,ASP
109	HOUSING,REAR
113	LABEL,INSTRUCTION
114	HARNESS
115	LABEL,PAPER SUPPORT;B
116	MIN SIDE LOCK#091Y
200	BOARD ASSY.,MAIN
300	BOARD ASSY.,POWER SUPPLY
350	BOARD ASSY.,PANEL
360	HARNESS
500	PRINTER MECHANISM ASP.;ESL
501	CARRIDGE ASSY.,ASP
502	BOARD ASSY.,CSIC
503	HOLDER,DETECTOR,PW
504	BOARD ASSY.,INK MARK

Table 7-2. Parts List for EPSON Stylus Photo R1800

Code	Parts Name
505	BOARD ASSY.,ENCORDER,CR
506	BOARD ASSY.,DETECTOR,PW
507	HOLDER,BOARD ASSY.,ENCORDER,PF
508	BOARD ASSY.,ENCORDER,PF
509	COVER IC ASSY.,ASP
511	SHAFT,CR,GUIDE
512	SCALE,CR
513	TORSION SPRING,24.7
514	MOTOR ASSY.,CR
515	CABLE,HEAD,B
516	CABLE,HEAD
517	DETECTOR,LEAF,B2
518	HARNESS,DETECTOR,CD-R
519	AUTO PG ASSY.,ASP
520	TRAY CDR BASE SUB ASSY.,ASP
521	INK SYSTEM ASSY.;B,ASP
522	PAPER GUIDE UPPER ASSY.,ASP
523	TORSION SPRING,PAPER GUIDE,UPPER
524	MOTOR ASSY.,PF
525	FRAME PAPER EJ ASSY ASP;ESL
526	ROLLER,PF ASSY.,ASP
528	PAPER GUIDE FRONT&ROLLER EJ ASSY,ASP;ESL
529	HOLDER RELEASE SUB ASSY.,ASP
532	PAPER DETECTOR ASSY.,ASP
533	PF ENCORDER ASSY.,ASP
534	RELEASE CD-R,LEFT ASSY.,ASP
535	RELEASE CD-R,RIGHT ASSY ASP; ESL
536	POROUS PAD,PAPER GUIDE,FRONT,LEFT,ASP
537	POROUS PAD,PAPER GUIDE,FRONT,CENTER,ASP
538	POROUS PAD,PAPER GUIDE,FRONT,ASP
539	POROUS PAD,GUIDE,INK EJECT,LEFT
540	POROUS PAD,GUIDE,INK EJECT,CENTER

Table 7-2. Parts List for EPSON Stylus Photo R1800

Code	Parts Name
541	HARNESS,ENCORDER,PF
542	HARNESS,BOARD ASSY.,RELAY
545	CLEANER,HEAD;C,ASP
547	POROUS PAD,GUIDE,INK EJECT
549	CABLE,DETECTOR,8
550	FRAG RELEASE ASSY.,ASP
551	COVER,ROLLER,LD
552	SHEET,SQUARE HOLE
700	PRINT HEAD
701	ASF UNIT,ASP
702	MOTOR,ASSY.,ASF
703	PAPER GUIDE,MANUAL
704	POROUS PAD SET,ASP
705	POROUS PAD,INK EJECT;LEFT;FA2
706	POROUS PAD,INK EJECT;LEFT;FB2
707	POROUS PAD,INK EJECT;LEFT;FC2
708	POROUS PAD,INK EJECT;LEFT;FD2
709	POROUS PAD,INK EJECT;LEFT;FE2
710	POROUS PAD,TUBE;FA2
711	POROUS PAD,TUBE;FB2
712	POROUS PAD,INK EJECT;RIGHT;FF2
713	POROUS PAD,INK EJECT;RIGHT;FG2
714	POROUS PAD,INK EJECT;RIGHT;FH2
715	POROUS PAD,INK EJECT;RIGHT;FI2
716	POROUS PAD,INK EJECT,IS,LEFT;B
717	POROUS PAD,INK EJECT,IS,LOWER,LEFT;B
718	POROUS PAD,INK EJECT,IS,LOWER;FB2
719	POROUS PAD,INK EJECT;H
720	POROUS PAD,CABLE,HEAD
721	LABEL,INK POSITION;B
723	LABEL,GUIDE,ROLL PAPER

Table 7-2. Parts List for EPSON Stylus Photo R1800

Code	Parts Name
723	LABEL,GUIDE,ROLL PAPER INSERT
724	CLAMP,TUBE

## 7.4 Circuit Diagram

---

Following pages show Circuit Diagram.

- C589 MAIN control circuit board 1
- C589 MAIN control circuit board 2
- C589 PSB power supply circuit board
- C589 PNL circuit board
- C589 PNL B circuit board



□ C589 MAIN control circuit board 1

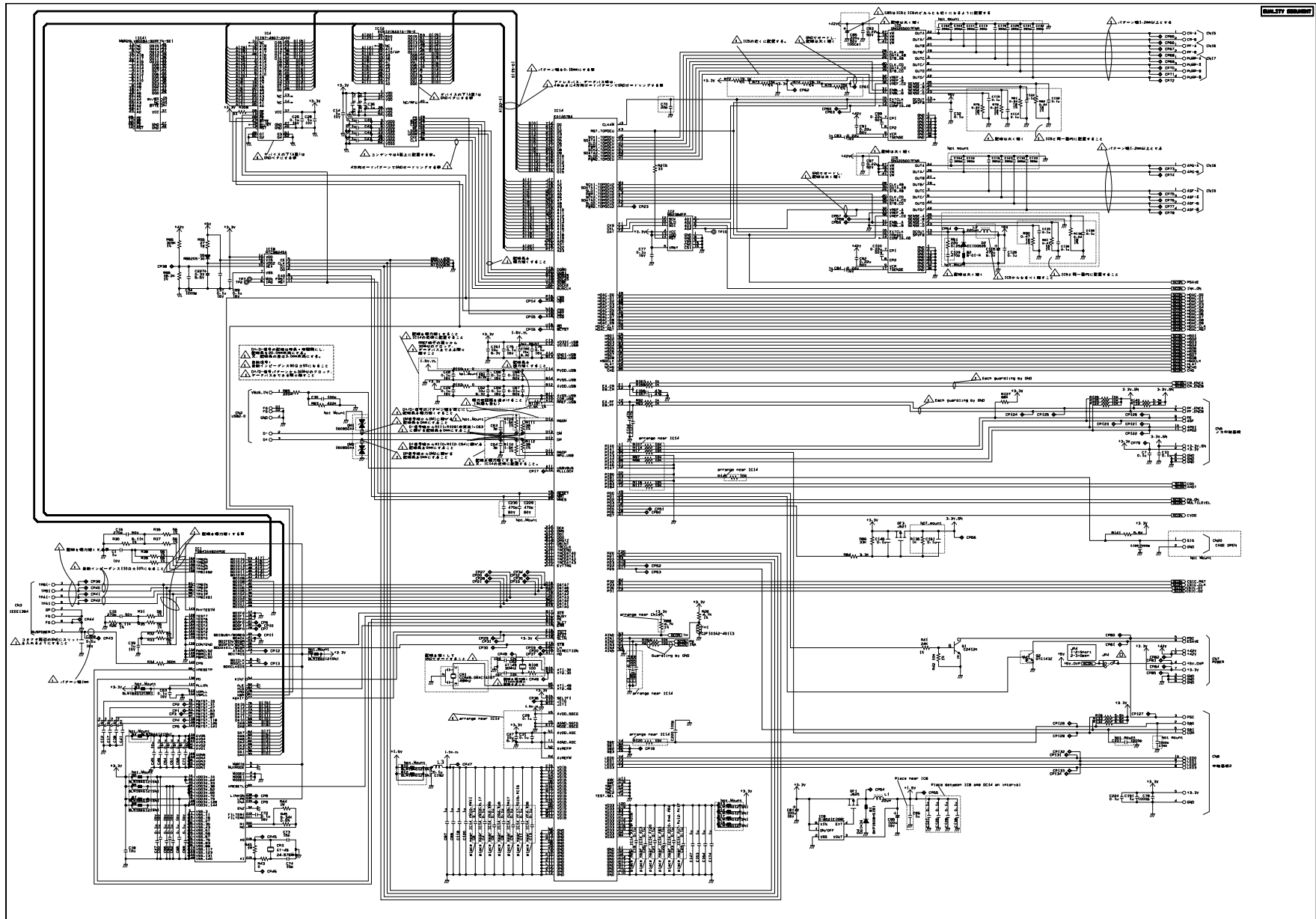

□ C589 MAIN control circuit board 2

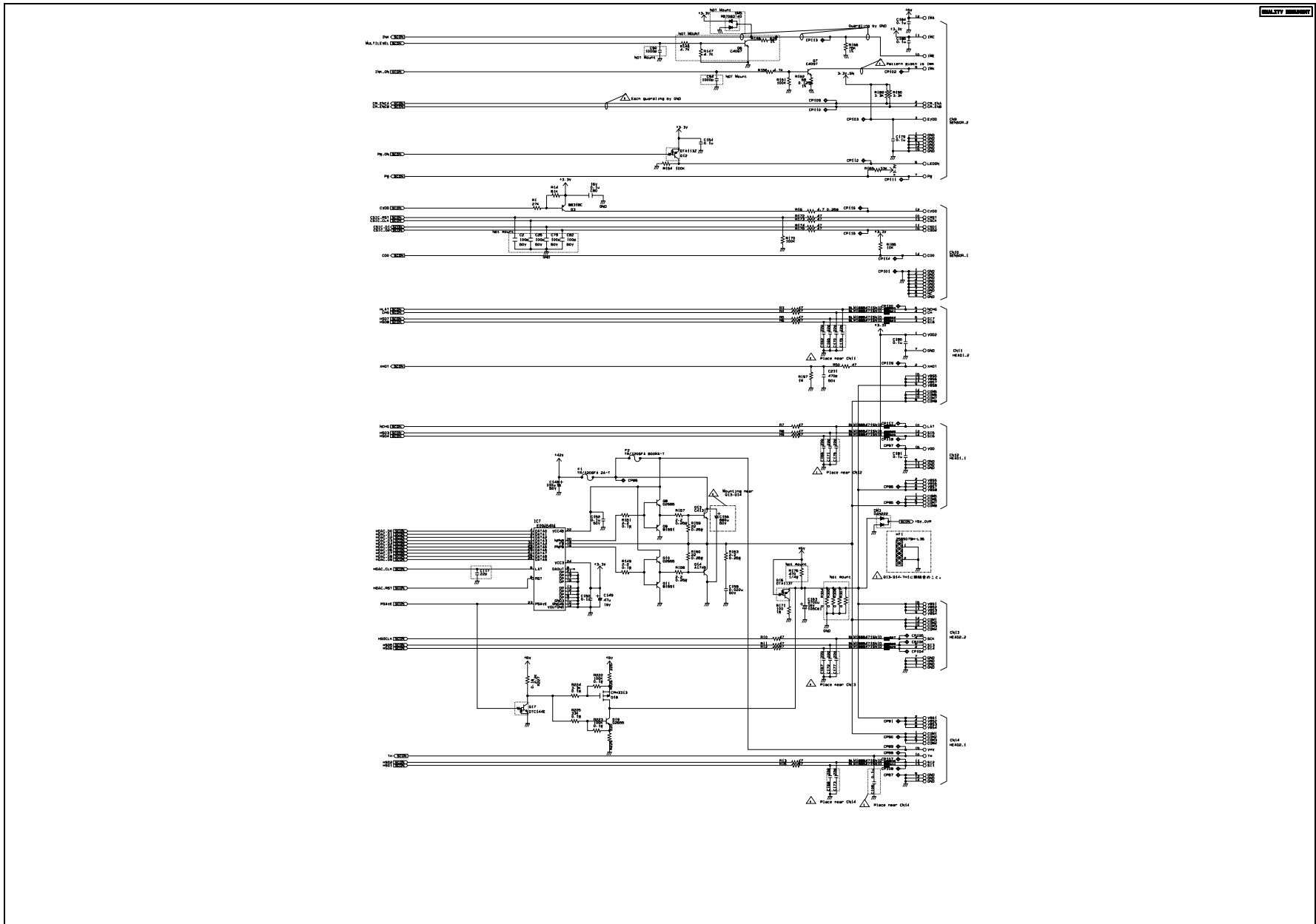



□ C589 PNL circuit board

QUALITY DOCUMENT

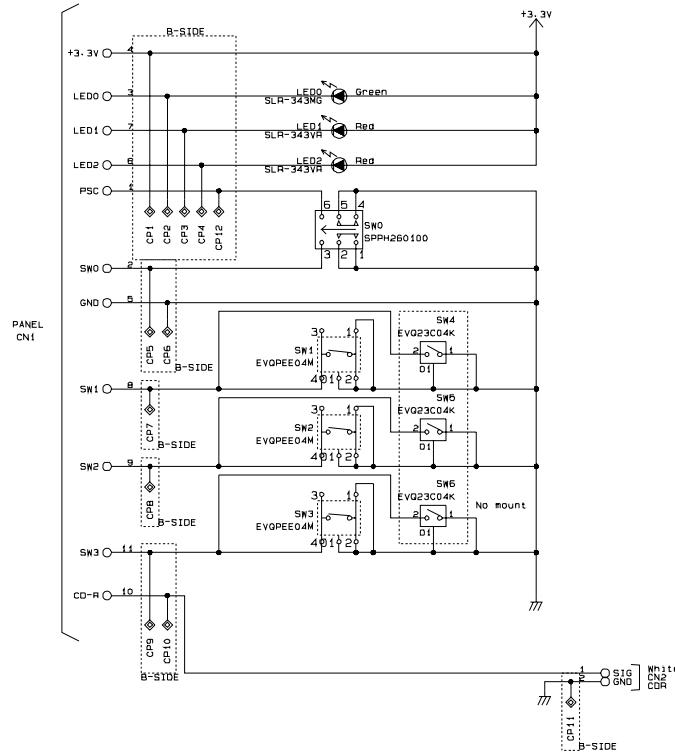

□ C589 PNL B circuit board

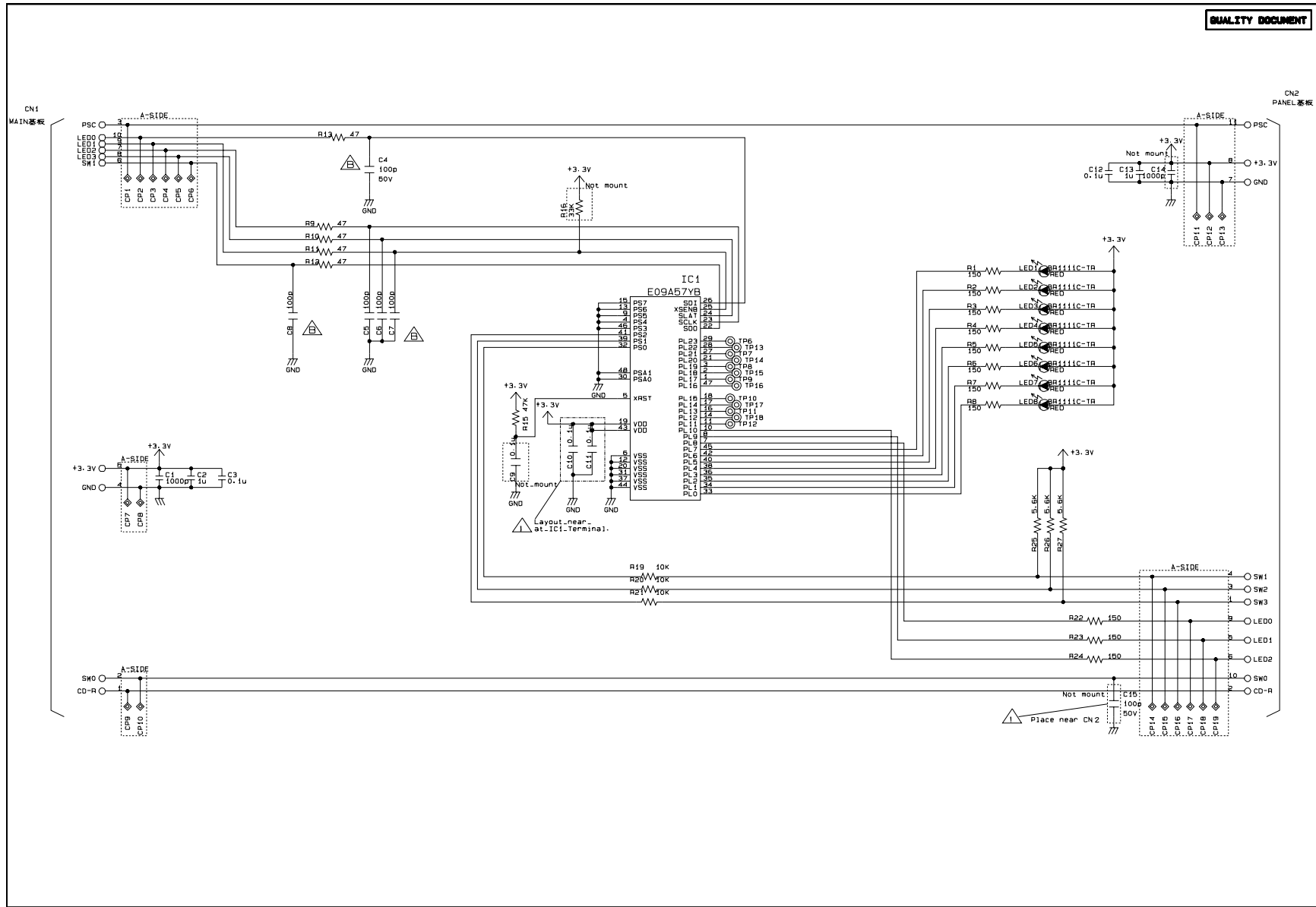

EPSON

CHAPTER

8

**STYLUS PHOTO R2400**

## 8.1 Overview

---

The Stylus Photo R2400 is a Stylus Photo R1800 - based inkjet color printer that supports a wide range of paper sizes from Letter to A3+. This chapter describes the specifications and functions that are unique to the Stylus Photo R2400. Refer to Chapter 1 to 7 for the information on the Stylus Photo R1800. This chapter includes:

- **Product Description**  
Describes the specifications unique to the Stylus Photo R2400.  
(Printing area, case specification, accessories, and environmental specification )
- **Operating Principles**  
Describes the operating principles unique to the Stylus Photo R2400.
- **Trouble Shooting**  
Describes the troubleshooting unique to the Stylus Photo R2400.

### 8.1.1 Overview

---

#### FEATURES

---

- High quality color printing
  - High quality phot printing using the Photo Mach technology
  - Much higher quality using the Microweave and Super Microweave
  - Highest resolution: 2880 x 1440 dpi minimum dot size: 3.2ng MSDT
- High-speed print
- Two built-in interfaces
  - IEEE 1394
  - USB 2.0 (HS compatible)
- Small and Compact
- Compatible Windows and Macintosh
- Multi paper size support ASF  
Automatic Sheet Feeder support for paper sizes from Letter to A3+
- CSIC-compatible independent color ink cartridges
- Roll paper support
- Quiet printing
- High-speed Borderless, edge to edge printing
- Duplex printing
- Preventing printing on the platen using the optical sensor
- Thick paper printing using the front paper feed
- Automatic Bi-D and dot detection using the multi sensor



## 8.1.2 Indicator Display in Normal Mode

Table 8-1. Printer Condition and LED Status

Printer status	Error status	Indicators			
		Power	Paper	Ink	Priority
Idle	–	On	–	–	20
Data processing	–	Blink	–	–	19
Ink sequence processing	–	Blink	–	–	17
Ink cartridge change mode	–	Blink	–	–	16
Ink low (warning)	–	–	–	Blink* <sup>2</sup>	15
Tear off status	11h	–	–	–	14
Cover Open (Tray) Error	2Bh	Fast Blink	Blink 2	–	–
Paper mismatch Error	0Ch	–	Fast Blink	–	12
Paper Out	06h	–	On	–	11
Ink end	05h	–	–	On* <sup>2</sup>	10
No Ink cartridge or Ink cartridge error	05h	–	–	On* <sup>2</sup>	9
Paper Jam Error	04h	–	Blink	–	8
Reset input* <sup>1</sup>	–	On	On	On	–
Fatal error	00h	Off	Fast Blink	Fast Blink	4
Maintenance request	10h	Off	Blink alternately 1	Blink alternately 2	2
Power off	–	Fast Blink	Off	Off	1

- Note:
- "–" : Don't care
  - Blink : 0.5sec on + 0.5sec off repetition
  - Blink 2 : 0.2sec on + 0.2sec + 0.2sec on + 0.4sec off repetition
  - Fast Blink : 0.1sec on + 0.1sec off repetition
  - Blink alternately 1 : 0.5sec on + 0.5sec off repetition
  - Blink alternately 2 : 0.5sec off + 0.5sec on repetition

Note\*\*1": When reset occurs (when the printer receives IEEE1284.4 "rs" command, or when printing of a status sheet is finished), the LEDs light for 0.2 second to indicate that the printer accepted the command.

\*\*2": The ink LED that corresponds to each cartridge row (A,BC,D,E,F,G, and H) is displayed independently.  
When facing front of printer, insertion locations (rows) of ink cartridges are taken as A,B,C,D,E,F,G, and H from the left. These rows correspond to LED1, LED2, LED3, LED4, LED5, LED6, LED7, and LED8, respectively.

### 8.1.3 Error Status

If any of the following states is detected, this printer is put in an error status and turns the interface signal -ERROR "Low" and BUSY "High" to inhibit data input. At this time, the printer is automatically disabled from printing. However, when communication is being made using the IEEE1284.4 protocol, communication with the printer is enabled.

- General error  
After the cause of this type of error is removed, the printer can resume its operation from where it stopped due to the error

**Table 8-2. General error**

Error Status	Occurring Condition	Resuming Condition
Ink color error	This error occurs when you replace a photo black ink cartridge to a matte black, or a matte black ink cartridge to a photo black during printing.	Return the combination of ink colors to the one before the error.
Cover open (tray) error	When the front cover is opened at ASF, roll paper or photo album printing mode, the printer goes this error.	Close the front cover.
Paper mismatch error	If the paper path specified by the print data is different from the printer's real paper path, the printer goes to this error.	Change the printer's paper path to the one specified by the data.
Paper out	When printer fails to load a sheet, it goes paper out error.	Set the paper to the ASF and push the Paper switch.
Ink out	When the printer runs out the most part of the ink of any one color, it warns ink-low and keeps printing. When the printer runs out the whole ink of any one color, it stops printing and indicates ink-out error.	Install the new Ink Cartridge.
No ink-cartridge	When printer detects that ink-cartridge comes off, it goes this error mode.	Install the new Ink Cartridge.
Paper jam	<ul style="list-style-type: none"> <li>• Failure of ejecting a sheet</li> <li>• Failure of loading a sheet to the loading position</li> </ul>	Remove the jammed paper.

- Fatal error  
After the cause of this type of error is removed, the printer cannot return to normal unless it is powered off and then on again

**Table 8-3. Fatal error**

Error Status	Occurring Condition	Resuming Condition
Maintenance request	When the total quantity of ink wasted through the cleanings and flushing is reaches to the limit, printer indicates this error and stops.	Replace the absorber in the printer enclosure by a service person.
Fatal errors	<ul style="list-style-type: none"> <li>• CR motor control error</li> <li>• PF motor control error</li> <li>• ASF motor control error</li> <li>• Auto Platen Gap control error</li> <li>• Head temperature error</li> <li>• PW sensor error</li> </ul>	Turn off and turn on.

## 8.2 Casing Specifications

### EXTERNAL DIMENSIONS

When tucked: 615 (width) x 314 (depth) x 223 mm (height)

When used: 615 (width) x 737 (depth) x 457 mm (height)

### WEIGHT

11.7 kg (without the Ink Cartridges, Roll paper holder)

### EXTERNAL DIMENSION DIAGRAM

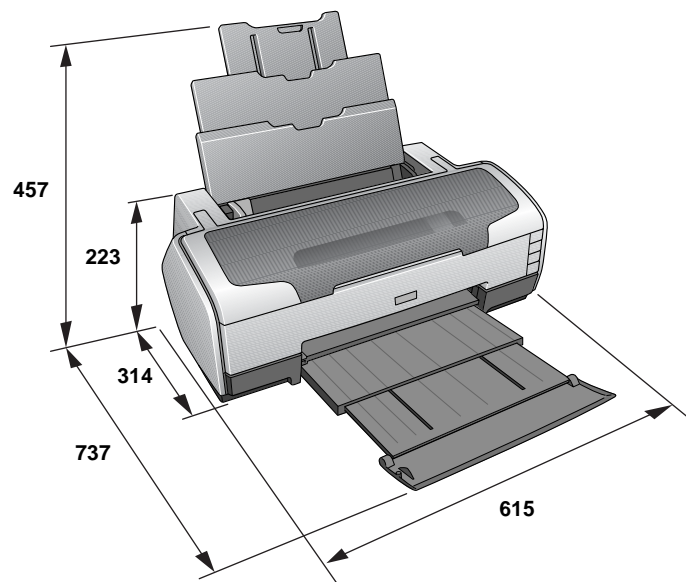

ê} 8-1. External Dimension Diagram

## 8.3 Accessories

### STANDARD ACCESSORIES

- Start Here
- Ink Cartridge (one for each of 9 colors)
- Power Cord
- Software CD-ROM
- Roll Paper Holder
- Multi-Sheet Matte Guide
- Rear Sheet Guide

### CONSUMABLES AND OPTIONS

- Ink Cartridges
  - Photo Black: : T0591
  - Cyan : T0592
  - Magenta : T0593
  - Yellow : T0594
  - Light Cyan : T0595
  - Light Magenta : T0596
  - Light Black : T0597
  - Matte Black : T0598
  - Light Light Black : T0599
- 802.11g Radio printing adapter: PA-W11G

### 8.3.1 Printhead Specifications

The Printhead of this product is a F-Mach head.  
The following shows the arrangement of the nozzles and the color arrangement of each nozzle line when viewed the Print Head from behind.

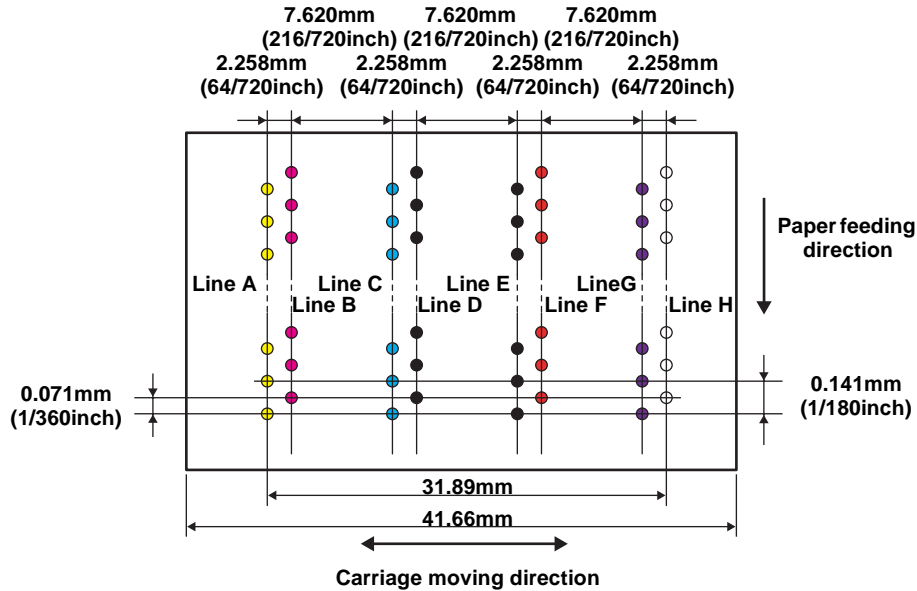

Figure 8-2. Nozzle Arrangement

Table 8-4. Nozzle Lines and the Corresponding Ink Color

Line	Ink
A	Light Light Black
B	Light Magenta
C	Light Cyan
D	Light Black
E	Photo-black / Matte-black
F	Cyan
G	Magenta
H	Yellow

### 8.3.2 Ink Sequence

□ Displacement cleaning / replacement cleaning  
This printe provides 2 patterns of combination of black inks in the E row. Refer to Table 8-4 "Nozzle Lines and the Corresponding Ink Color" on page 203. When replacing the ink cartridges using the 2 patterns that are mentioned above with the carriage unit at the home position, 2 types of displacement cleaning are performed to prevent a new ink from mixing with a old one. If the ink types are not displaced in the E row, a replacement cleaning is performed instead of a displacement cleaning.

- Cartridge displacement CL  
3.09g (0.425g per color)
- Cartridge replacement CL1: each color  
Suction amount 3.09g (0.386g per color)
- Cartridge replacement CL2: each color  
Suction amount 3.14g (0.393g per color)

## 8.4 Overview

---

This chapter describes unit-level troubleshooting.

### 8.4.1 Troubleshooting according to Panel Messages

After checking the printer LED and EPW3 error indications, you can grasp the fault location using the check list in this section. When you find the fault location, refer to Chapter 4 "Disassembly and Reassembly" and change the corresponding part and/or unit. The following table indicates the check point reference tables corresponding to the error states (LED and EPW3).

**Table 8-5. Reference Tables of Error States**

<b>Error State</b>	<b>Reference Table</b>
Communication Error	<a href="#">Refer to Table 8-6 "Troubleshooting of Communication Error" on page 205</a>
Model Difference	<a href="#">Refer to Table 8-6 "Troubleshooting of Communication Error" on page 205</a>
Cover Open (Tray) Error	<a href="#">Refer to Table 8-7 "Troubleshooting of Cover Open Error" on page 208</a>
Paper Out Error	<a href="#">Refer to Table 8-8 "Troubleshooting of Paper Out Error" on page 209</a>
Paper Jam Error	<a href="#">Refer to Table 8-9 "Troubleshooting of Paper Jam Error" on page 212</a>
Paper Mismatch Error	<a href="#">Refer to Table 8-11 "Troubleshooting of Paper Mismatch Error" on page 214</a>
Ink Low	<a href="#">Refer to Table 8-12 "Troubleshooting of Ink Low" on page 214</a>
Ink Out Error	<a href="#">Refer to Table 8-13 "Troubleshooting of Ink Out Error" on page 214</a>
No Ink Cartridge/CSIC Error	<a href="#">Refer to Table 8-14 "Troubleshooting of No Ink Cartridge/Ink Cartridge Error" on page 215</a>
Maintenance Request Error	<a href="#">Refer to Table 8-15 "Troubleshooting of Maintenance Request" on page 217</a>
Fatal Error	<a href="#">Refer to Table 8-16 "Troubleshooting of Fatal Error" on page 218</a>

Table 8-6. Troubleshooting of Communication Error

Occurrence Timing	Phenomenon Detail	Faulty Part/ Part Name	Check Point	Remedy
At power-on	The printer does not operate at all.	Panel FFC	1. Check that the Panel FFC is connected to the Panel Board Connector and LED Board Connector. 	1. Connect the Panel FFC to the Panel Board and LED Board connectors.
			2. Check the Panel FFC for damages.	2. Replace the Panel FFC with a new one.
		Panel Board	1. Check the Panel Board for damages.	1. Replace the Panel Board with a new one.
		LED FFC	1. Check that the LED FFC is connected to the LED Board Connector and Main Board Connector CN8. 	1. Connect the LED FFC to the LED Board Connector and Main Board Connector CN8.
			2. Check the LED FFC for damages.	2. Replace the LED FFC with a new one.

Table 8-6. Troubleshooting of Communication Error

Occurrence Timing	Phenomenon Detail	Faulty Part/ Part Name	Check Point	Remedy
<p>At power-on</p>	<p>The printer does not operate at all.</p>	<p>Power Supply Board</p>	<p>1. Check that the Connector Cable of the Power Supply Board is connected to the Main Board Connector CN7.</p> 	<p>1. Connect the Connector Cable of the Power Supply Board to the Main Board Connector CN7.</p>
			<p>2. Check that the blue colored pin of the Power Supply Board Connector cable is inserted into the 1 Pin of the Main Board Connector CN7 as shown in the above picture.</p>	<p>2. Reconnect the Power Supply Board Connector cable so that the blue colored pin is inserted into the 1 Pin.</p>
			<p>3. Check that the Fuse F1 on the Power Supply Board has not blown.</p>	<p>3. Replace the Power Supply Board with a new one.</p>
			 <p>4. Check the components on the Power Supply Board for damage.</p>	<p>4. Replace the Power Supply Board with a new one.</p>

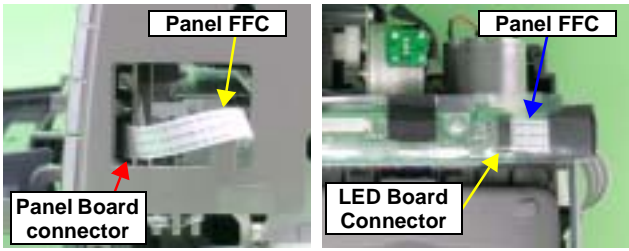
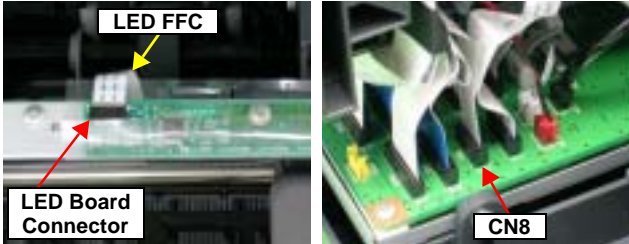

Table 8-6. Troubleshooting of Communication Error

Occurrence Timing	Phenomenon Detail	Faulty Part/ Part Name	Check Point	Remedy
At power-on	After the power-on sequence has started, the LED turns off and the printer does not operate.	Main Board	<p>1. Check that the Relay connector of the ASF Motor and the Relay connector of the Pump Motor are not connected to the wrong connector causing a short circuit.</p> 	1. Connect the Relay Connector of the ASF Motor and the Relay Connector of the Pump Motor correctly, and replace the Main Board with a new one.
At operation	Operation at power-on is normal, but the error appears when the print job is sent to the printer.	Interface cable	<p>1. Check that the Interface cable is connected between the PC and printer.</p> <p>2. Check the Interface cable for breaking.</p>	<p>1. Connect the Interface cable to the PC and printer.</p> <p>2. Replace the Interface cable with a new one.</p>
		EPSON USB driver	1. When using USB, check that the EPSON USB driver has been installed on the PC.	1. Install the EPSON USB driver.
		USB	1. Check that the PC and printer are connected via the USB hub.	1. Enter the USB serial No. indicated on the product nameplate. Refer to Chapter 5 " <a href="#">Adjustment</a> ".
		IEEE1394	1. Check that the same code as the IEEE1394 QR label code is saved in the EEPROM address (from BA-H to BE-H).	1. Input the code given as the IEEE1394 QR label code. Refer to Chapter 5 " <a href="#">Adjustment</a> ".
		Printer Driver	1. Check that the printer driver for Stylus Photo R2400 has already been installed.	1. Install the printer driver for Stylus Photo R2400.
			2. Check that the connected printer is Stylus Photo R2400.	2. Connect the Stylus Photo R2400 printer.
Main Board	1. Check that a wrong model name has not been input to the EEPROM address (E0<H>) on the Main Board.	1. Using the Adjustment Program, enter the correct model name (save 01 into E0<H>). Refer to Chapter 5 " <a href="#">Adjustment</a> ".		

Table 8-7. Troubleshooting of Cover Open Error

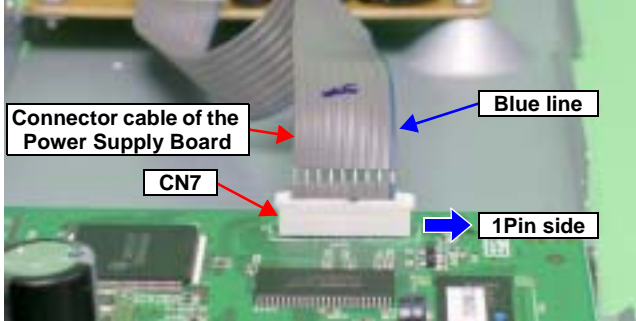
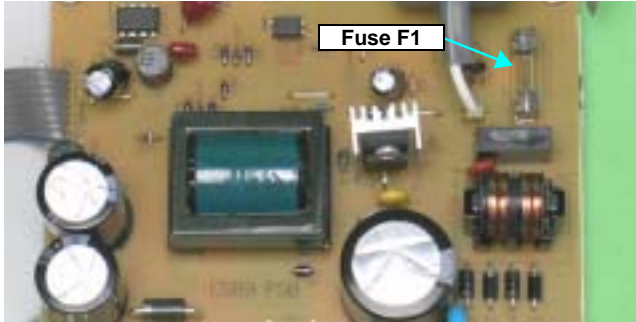
Occurrence Timing	Phenomenon Detail	Faulty Part/ Part Name	Check Point	Remedy
During printing	A Cover Open (Tray) Error is indicated during printing.	Printer Cover	1. Check that the front cover is not open.	1. Close the front cover.

Table 8-8. Troubleshooting of Paper Out Error

Occurrence Timing	Phenomenon Detail	Faulty Part/ Part Name	Check Point	Remedy
At operation	When the Paper Switch is pressed, the LD Roller attempt to feed paper but the paper is not fed.	ASF Assy.	1. Check the LD Roller or Retard Roller of the ASF Assy for paper dust and foreign matter.	<p>1. Using a cleaning sheet (part code:1262115), clean the LD Roller and Retard Roller. The procedure is as follows.</p> <ol style="list-style-type: none"> <li>(1) Place the cleaning sheet upside down and put it into the ASF Assy.</li> <li>(2) Press the Paper Switch to start paper feed.</li> <li>(3) Repeat the above steps several times.</li> </ol> <p>* To remove persistent contamination, staple an alcohol-dampened cloth to a postcard and clean the rollers in the following method.</p> <div style="text-align: center;">  </div> <ol style="list-style-type: none"> <li>(1) Place the alcohol-dampened cloth toward the LD Roller surface of the ASF Assy.</li> <li>(2) Hold the mount top end securely and press the Paper Switch.</li> <li>(3) Repeat the paper feed sequence several times to clean the LD Roller surface of the ASF Assy.</li> </ol>

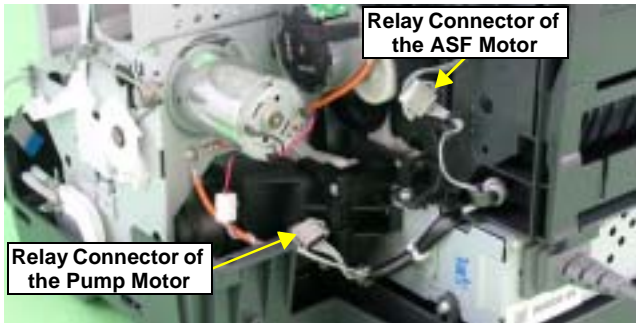
Table 8-8. Troubleshooting of Paper Out Error

Occurrence Timing	Phenomenon Detail	Faulty Part/ Part Name	Check Point	Remedy
<p>At operation</p>	<p>Though paper is fed from the ASF Assy, it stops near the PE Sensor Lever.</p>	<p>PE Sensor</p>	<p>1. Check that the Connector cable of the PE Sensor is securely connected to the PE Sensor and Relay Board Connector CN2.</p> 	<p>1. Connect the Connector cable of the PE Sensor to the PE Sensor and Relay Board Connector CN2.</p>
			<p>2. Check that the Sensor Holder is mounted to the Mechanical frame correctly.</p> 	<p>2. Install the Sensor Holder correctly.</p>
			<p>3. Move the Detection Lever manually as when the paper passes, and check that the Detection Lever returns to the original position automatically by the Torsion Spring when released. Refer to the above photo.</p>	<p>3. Replace the PE Sensor Holder Unit with a new one.</p>
			<p>4. Using a tester, check that the PE Sensor is normal.</p> <ul style="list-style-type: none"> <li>· Paper absent : 2.4V or more</li> <li>· Paper present : 0.4V or less</li> </ul>	<p>4. Replace the PE Sensor Holder Unit with a new one.</p>

Table 8-8. Troubleshooting of Paper Out Error

Occurrence Timing	Phenomenon Detail	Faulty Part/ Part Name	Check Point	Remedy
<p>The Paper Switch was pressed at the setting of the CD-R Tray or board paper</p>	<p>Though the CD-R Tray or the Board Paper is fed toward the ASF Assy, but is ejected immediately.</p>	<p>PW sensor</p>	<p>1. Check the PW Sensor for paper dust, ink, etc.</p> 	<p>1. Clean the PW Sensor surface.</p>
			<p>2. Compare the EEPROM values in two places (50&lt;H&gt; and 51&lt;H&gt;) and check that they are not approximate to each other.</p>	<p>2. Replace the PW Sensor with a new one.</p>
<p>The Paper Switch was pressed at the setting of the board paper</p>	<p>The Board Tray moves toward the ASF and the posterior edge of it reaches to the Driven Roller on the Upper Paper Guide. Then the Board Tray tries to go farther, but it is ejected.</p>	<p>PW sensor</p>	<p>1. Check that the PW Sensor FFC is placed in the specified routing positions and does not make contact with any parts.</p> 	<p>1. Place the PW Sensor FFC in the specified routing positions.</p>
			<p>2. Check that the PW Sensor FFC is connected to the CR Encoder Board and PW Sensor Connectors. Refer to the above photo.</p>	<p>2. Connect the FFC to the CR Encoder Board and PW Sensor Connectors.</p>
			<p>3. Check the PW Sensor or PW Sensor FFC for damages.</p>	<p>3. Replace the PW Sensor with a new one.</p>

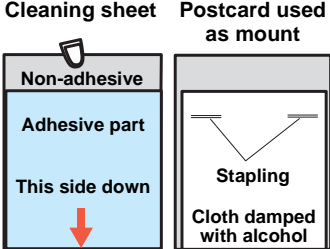
Table 8-9. Troubleshooting of Paper Jam Error

Occurrence Timing	Phenomenon Detail	Faulty Part/ Part Name	Check Point	Remedy
At operation	At the time of paper ejection, the PF Roller advances the paper but cannot eject it completely.	-	1. Check that the size of the fed paper is not larger than that of the paper specified by the driver.	1. Tell the user that the paper size specified by the driver is not available for the printer.
	Paper is not ejected completely and causes a jam near the Paper Eject Frame.	ASF Assy.	1. Check that the paper is fed along the Right Edge Guide.	1. Feed the paper along the Right Edge Guide.
		Paper EJ Frame Assy.	1. Check that the Star Wheel Units have not come off the Paper EJ Frame Assy.   The diagram shows the Paper EJ Frame Assy with a red box highlighting the Star Wheel Units. Labels with arrows point to the 'Paper EJ Frame Assy.' and 'Star Wheel Units'.	1. Securely install the Star Wheel Units to the Paper EJ Frame Assy.
			2. Check the Paper EJ Frame Assy for deformation or damages.	2. Replace the Paper EJ Frame Assy with a new one.
		Spur Gear 68 Spur Gear 16; B Paper EJ Roller Assy.(front/rear)	1. Check the Spur Gear 68 or Spur Gear 16; B for damages.   The diagram shows the internal gear mechanism. A blue arrow points to Spur Gear 68, and a yellow arrow points to Spur Gear 16; B. Labels with arrows identify 'Spur Gear 16; B' and 'Spur Gear 68'.	1. Replace the Front (or Rear) Paper EJ Roller Assy with a new one.

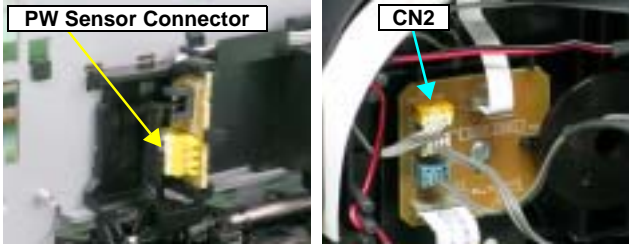
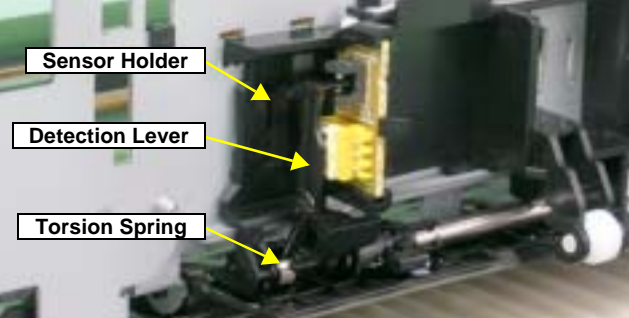
Table 8-10. Troubleshooting of Card Loading Error

Occurrence Timing	Phenomenon Detail	Faulty Part/ Part Name	Check Point	Remedy
During printing	Printing starts but paper is not fed.	-	1. Check that the card size paper is loaded in the portrait orientation.	1. Load the cards of the same size correctly, and press the Paper Switch to eject the jammed paper.
	The card size paper is loaded correctly, but Card Loading Error is displayed.	PW sensor	1. Check that the PW Sensor FFC is connected to the CR Encoder Board and PW Sensor Connectors.  2. Check the PW Sensor or PW Sensor FFC for damages.	1. Connect the FFC to the CR Encoder Board or PW Sensor. 2. Replace the PW Sensor with a new one.

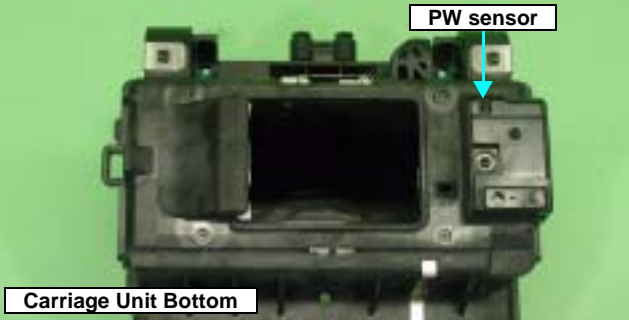
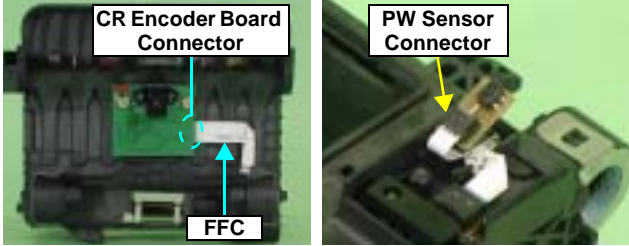

**Table 8-11. Troubleshooting of Paper Mismatch Error**

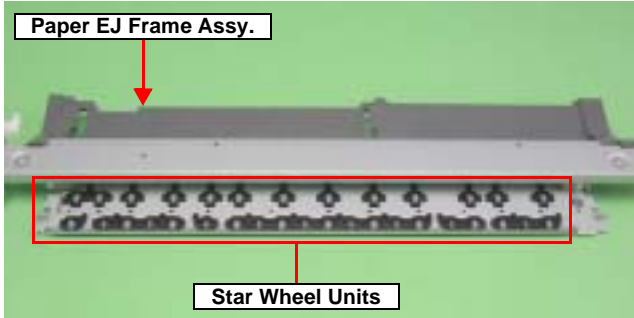
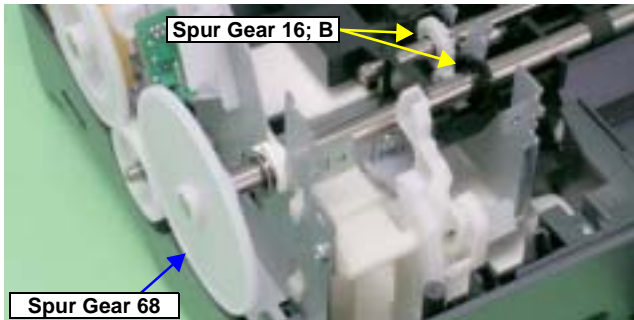
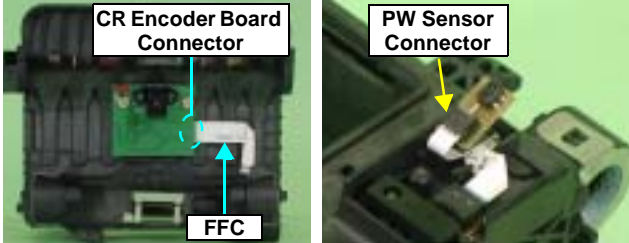
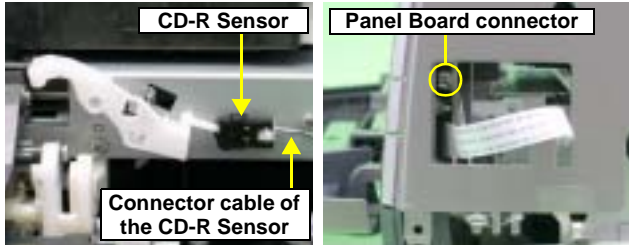
Occurrence Timing	Phenomenon Detail	Faulty Part/Part Name	Check Point	Remedy
At operation	When feeding a Board Paper, an error is displayed on the LED and EPW3.	Paper EJ Frame Assy	1. Check if the CD-R Tray Base(Board Tray Base) is closed or not.	1. Open the CD-R Tray Base(Board Tray Base) .
		CD-R Sensor (Board Sensor)	1. Check that the Connector cable of the CD-R Sensor is securely connected to the connectors of the CD-R Sensor and Panel Board. 	1. Connect the Connector cable of the CD-R Sensor (Board Sensor) to the CD-R Sensor (Board Sensor) and Panel Board Connectors.  2. Replace the CD-R Sensor(Board Sensor) with a new one.

**Table 8-12. Troubleshooting of Ink Low**

Occurrence Timing	Phenomenon Detail	Faulty Part/Part Name	Check Point	Remedy
At operation or during printing	A message is displayed on the LED and EPW3 during printing.	Ink Cartridge	1. Look at the remaining ink indication of the EPW3 to check the amount of the ink remaining in the Ink Cartridge.	1. Prepare a new Ink Cartridge.

**Table 8-13. Troubleshooting of Ink Out Error**

Occurrence Timing	Phenomenon Detail	Faulty Part/Part Name	Check Point	Remedy
During printing	After the Carriage has detected the HP, an error is displayed on the LED and EPW3.	Ink Cartridge	1. Look at the remaining ink indication of the EPW3 to check whether the ink remains in the Ink Cartridge.	1. Replace the Ink Cartridge with a new one.

Table 8-14. Troubleshooting of No Ink Cartridge/Ink Cartridge Error



Occurrence Timing	Phenomenon Detail	Faulty Part/ Part Name	Check Point	Remedy
At power-on	After the Carriage has detected the HP, an error is displayed on the LED and EPW3.	Ink Cartridge	1. Check that the Ink Cartridge is installed correctly.	1. Install the Ink Cartridge correctly.
			2. Check that the tab of the Ink Cartridge is not broken.	2. Replace the Ink Cartridge with a new one.
			 <p>An image of an EPSON ICY12 ink cartridge. A blue arrow points to a small white tab on the right side of the cartridge, which is labeled 'Tab' in a white box.</p>	
3. Check that the Memory Chip is not disconnected or not damaged.	3. Replace the Ink Cartridge with a new one.			
 <p>An image of an EPSON ICY12 ink cartridge. A blue arrow points to a small green chip on the bottom edge of the cartridge, which is labeled 'Memory Chip' in a white box.</p>				

Table 8-14. Troubleshooting of No Ink Cartridge/Ink Cartridge Error

Occurrence Timing	Phenomenon Detail	Faulty Part/ Part Name	Check Point	Remedy
At power-on	After the Carriage has detected the HP, an error is displayed on the LED and EPW3.	CSIC FFC	1. Check that the CSIC FFC is connected to the CSIC Board Connector and Main Board Connector CN10. 	1. Connect the CSIC FFC to the CSIC Board Connector and Main Board Connector CN10.
			2. Check the CSIC FFC for damage.	2. Replace the CSIC FFC with a new one.
		CSIC Board	1. Check the CSIC Board for damage. 	1. Replace the CSIC Board with a new one.
Carriage Unit	1. Check that the electrodes in the Carriage, which make contact with the CSIC Board, are not bent. 	1. Replace the Carriage Unit with a new one.		

Table 8-15. Troubleshooting of Maintenance Request

Occurrence Timing	Phenomenon Detail	Faulty Part/ Part Name	Check Point	Remedy
At power-on	At power-on, the printer does not operate at all.	Waste Ink Pads	1. Using the Adjustment Program, check if the Protection Counter A+B value has exceeded 17540.	1. Replace the Waste Ink Pads and reset the Protection Counter A and B value with the Adjustment Program.

Table 8-16. Troubleshooting of Fatal Error

Occurrence Timing	Phenomenon Detail	Faulty Part/ Part Name	Check Point	Remedy
At power-on	At power-on, the CR Motor does not operate at all.	CR Motor	1. Check that the CR Motor connector cable is connected to the Relay Connector. 	1. Connect the CR Motor connector to the Relay Connector.
		2. Check the CR Motor connector cable for damages.	2. Replace the CR Motor with a new one.	
		3. Check if the CR Motor operates normally.	3. Replace the CR Motor with a new one.	
		Relay Connector Cables (for the CR Motor)	1. Check that the Relay Connector Cable is connected to the Main Board Connector CN15. 	1. Connect the Relay Connector Cable to the Main Board Connector CN15.
		2. Check the Relay Connector Cable for damages.	2. Replace the Relay Connector Cable with a new one.	

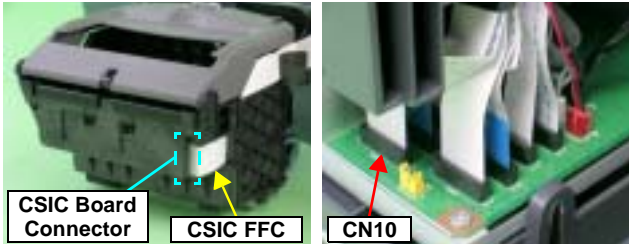
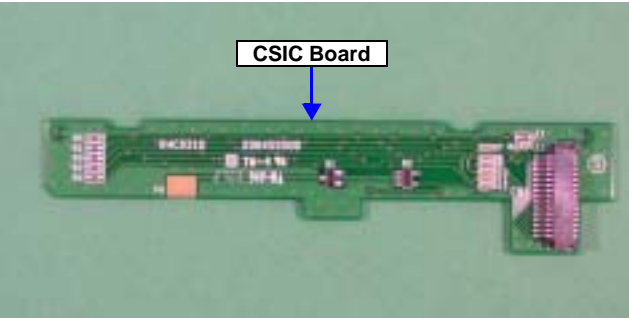
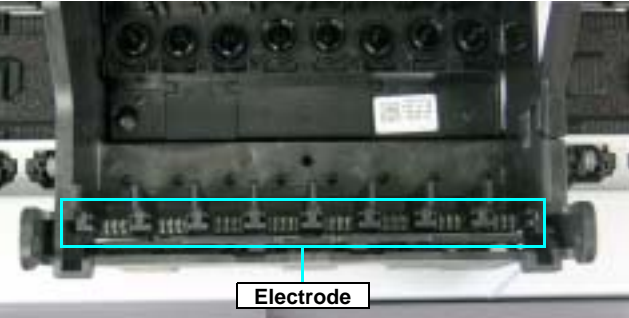
Table 8-16. Troubleshooting of Fatal Error

Occurrence Timing	Phenomenon Detail	Faulty Part/ Part Name	Check Point	Remedy
At power-on	The power-on sequence is executed but Fatal error is displayed.	CR drive mechanism	1. Check that the Carriage Shaft is lubricated with grease. 	1. Wipe the surface of the Carriage Shaft with a dry, soft cloth, and lubricate the Carriage Shaft with grease G-71. Refer to Chapter 6 " <i>Maintenance</i> ".
	At power-on, the PF Motor does not operate at all.	PF Motor	1. Check that the Connector Cable of the PF Motor is connected to the Main Board Connector CN16. 	1. Connect the PF Motor connector cable to the Main Board Connector CN16.
			2. Check the PF Motor connector cable for damages.	2. Replace the PF Motor with a new one.
			3. Check if the PF Motor operates normally.	3. Replace the PF Motor with a new one.

Table 8-16. Troubleshooting of Fatal Error

Occurrence Timing	Phenomenon Detail	Faulty Part/ Part Name	Check Point	Remedy
At power-on	At power-on, the APG Motor does not operate at all.	APG Motor	1. Check that the Connector Cable of the APG Motor is connected to the Main Board Connector CN18.	1. Connect the APG Motor connector cable to the Main Board Connector CN18.
				
			2. Check the APG Motor connector cable for damage.	
3. Check if the APG Motor operates normally.	3. Replace the APG Motor with a new one.			
At power-on, the Pump Motor does not operate at all.	At power-on, the Pump Motor does not operate at all.	Pump Motor	1. Check that the Pump Motor connector cable is connected to the Relay Connector.	1. Connect the Pump Motor connector cable to the Relay Connector.
				
			2. Using a tester, check the resistance value of the Pump Motor. Value of resistance : $10.3\Omega \pm 10\%$	
3. Check the Pump Motor connector cable for damages.	3. Replace the Ink System Unit with a new one.			

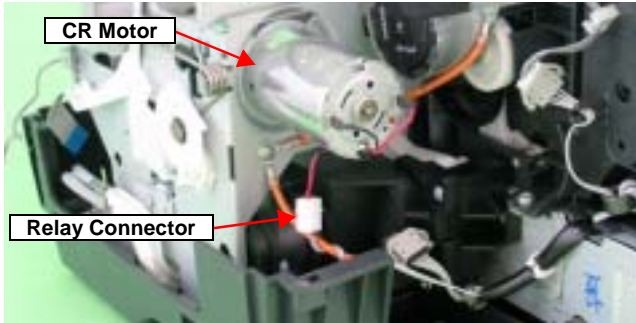
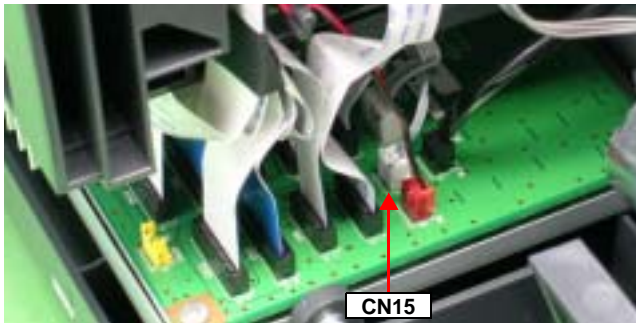

Table 8-16. Troubleshooting of Fatal Error

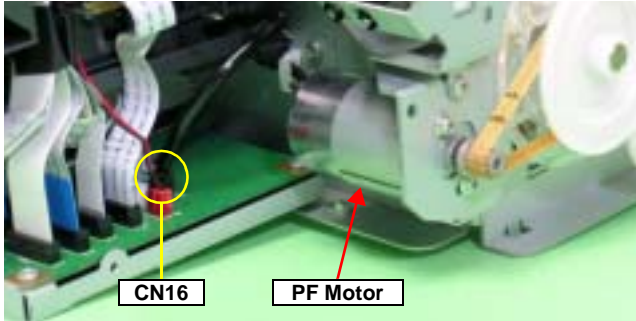
Occurrence Timing	Phenomenon Detail	Faulty Part/ Part Name	Check Point	Remedy
At power-on	At power-on, the Pump Motor does not operate at all.	Relay Connector Cables (for Pump Motor)	1. Check that the Relay Connector Cable is connected to the Main Board Connector CN17. 	1. Connect the Relay Connector Cable to the Main Board Connector CN17.
			2. Check the Relay Connector Cable for damages.	2. Replace the Relay Connector Cable with a new one.
	While the power-on sequence is being executed, Fatal error is displayed.	APG Sensor	1. Check that the APG Sensor Connector cables are connected to the APG Sensors and Relay Board Connector CN4 and CN5. 	1. Connect the APG Sensor Connector cables to the APG Sensors and Relay Board Connector CN4 and CN5.
			2. Check the APG Sensors for damages.	2. Replace the APG Sensors with new ones.

Table 8-16. Troubleshooting of Fatal Error

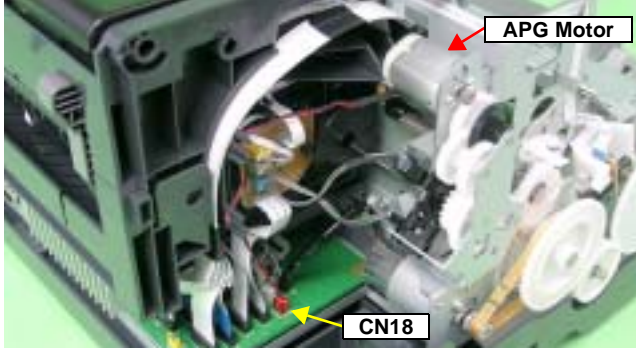
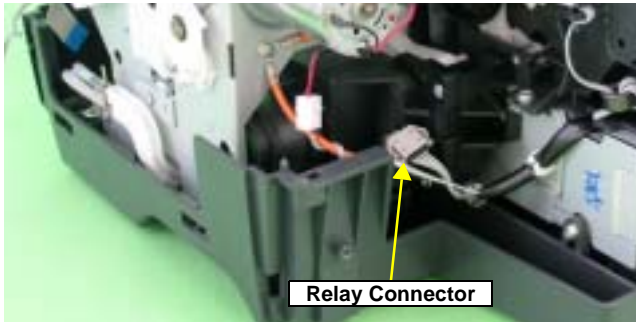
Occurrence Timing	Phenomenon Detail	Faulty Part/ Part Name	Check Point	Remedy
At power-on	While the power-on sequence is being executed, Fatal error is displayed.	ASF Motor	1. Check that the Connector cable of the ASF Motor is connected to the Relay Connector. 	1. Connect the Connector cable of the ASF Motor to the Relay Connector.
		2. Using a tester, check the resistance value of the ASF Motor. Value of resistance : $7.0\Omega \pm 10\%$	2. If the resistance value is abnormal, replace the ASF Motor with a new one.	
		3. Check the ASF Motor connector cable for damages.	3. Replace the ASF Motor with a new one.	
		Relay Connector Cable (for the ASF Motor)	1. Check that the Relay Connector Cable is connected to the Main Board Connector CN19. 	1. Connect the Relay Connector Cable to the Main Board Connector CN19.
		2. Check the Relay Connector Cable for damages.	2. Replace the Relay Connector Cable with a new one.	

Table 8-16. Troubleshooting of Fatal Error

Occurrence Timing	Phenomenon Detail	Faulty Part/ Part Name	Check Point	Remedy
At power-on	While the power-on sequence is being executed, Fatal error is displayed.	Relay FFC	1. Check that the Relay FFC is connected to the Relay Board Connector CN1 and Main Board Connector CN5. 	1. Connect the Relay FFC to the Relay Board Connector CN1 and Main Board Connector CN5.
			2. Check the Relay FFC for damages.	2. Replace the Relay FFC Cable with a new one.
At power-on, the Carriage Unit moves away from the home position and bumps against the right of the Frame, then hits the left of the Frame.		CR Scale	1. Check that the CR Scale is inserted in the slit of the CR Encoder Sensor. 	1. Insert the CR Scale into the slit of the CR Encoder Sensor.
			2. Check the CR Scale for damages and dirt.	2. Wipe off the dirt completely or replace the CR Scale with a new one.
		CR Encoder Sensor Board	1. Check the CR Encoder Sensor for paper dust, etc.	1. Remove the paper dust, etc. from the CR Encoder Sensor.
	2. Check the CR Encoder Sensor Board for damages.	2. Replace the CR Encoder Sensor Board with a new one.		

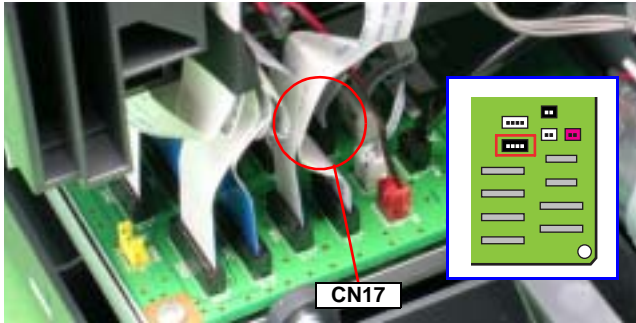
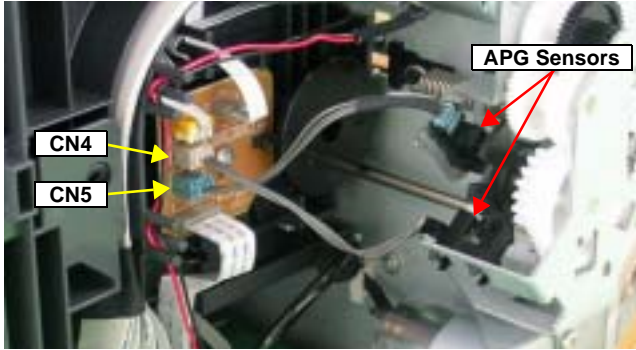
Table 8-16. Troubleshooting of Fatal Error

Occurrence Timing	Phenomenon Detail	Faulty Part/ Part Name	Check Point	Remedy
At power-on	At power-on, the Carriage Unit moves away from the home position and bumps against the right of the Frame, then hits the left of the Frame.	Sensor FFC	1. Check that the Sensor FFC is connected to the CR Encoder Sensor Board Connector and Main Board Connector CN9.	1. Connect the Sensor FFC to the CR Encoder Sensor Board Connector and Main Board Connector CN9.  2. Replace the Sensor FFC with a new one.
				
At power-on, the PF Roller rotates fast about a half turn.		PF Encoder Sensor Holder	1. Check that the PF Encoder Sensor Holder is mounted correctly.	1. Install the PF Encoder Sensor Holder correctly.
			2. Check that the FFC of the PF Encoder Sensor is securely connected to the PF Encoder Sensor Board Connector and Relay Board Connector CN6.	2. Connect the PF Encoder Sensor FFC to the PF Encoder Sensor Board and Relay Board Connector CN6.
				
			3. Check the PF Encoder Sensor for paper dust, etc.	3. Remove the paper dust, etc. from the PF Encoder Sensor.
4. Check if the PF Encoder or the FFC is damaged.	4. Replace the PF Encoder with a new one.			

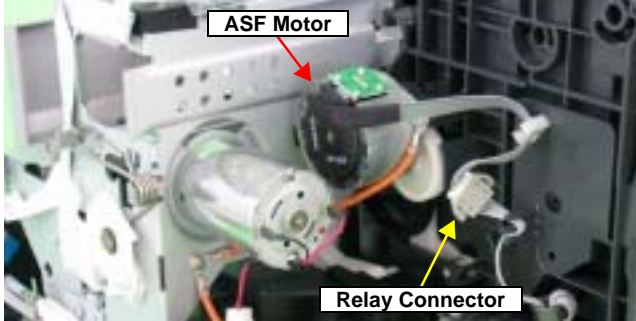
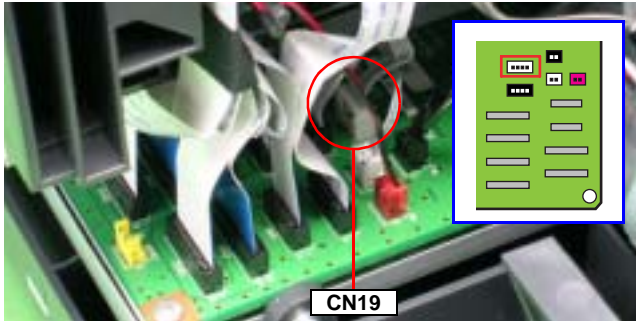
Table 8-16. Troubleshooting of Fatal Error

Occurrence Timing	Phenomenon Detail	Faulty Part/ Part Name	Check Point	Remedy
At power-on	At power-on, the PF Roller rotates fast about a half turn.	PF Scale	1. Check that the PF Scale is inserted in the slit of the PF Encoder Sensor.	1. Install the PF Scale in the slit of the PF Encoder Sensor correctly.
				
During printing	After receiving a print data, or while performing the CD-R Tray home position detection sequence (Board Paper detection), an error is displayed on the LED and EPW3.	Head FFC Sensor FFC	1. Check that the Head FFC and the Sensor FFC are securely connected to the Main Board Connectors CN9 through CN14.	1. Connect the Head FFC and the Sensor FFC to the Main Board Connectors CN9 through CN14.
				

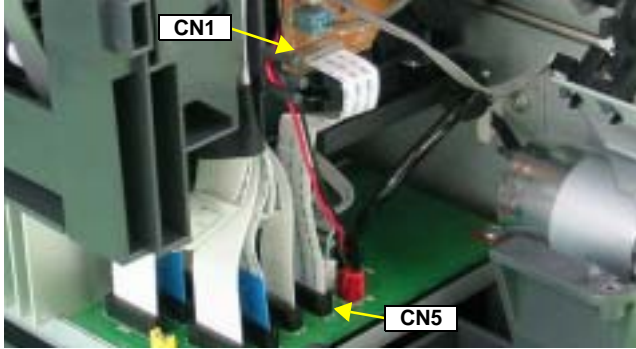
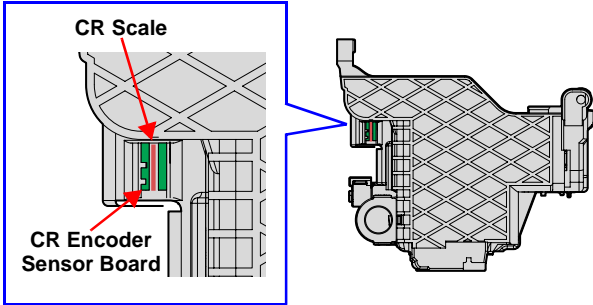
Table 8-16. Troubleshooting of Fatal Error

Occurrence Timing	Phenomenon Detail	Faulty Part/ Part Name	Check Point	Remedy
During printing	After starting to print, ink is not ejected and paper stops midway.	Head FFC	1. Check that the Head FFC is securely connected to the Print Head Connector and Main Board Connectors CN10, CN12, CN13, and CN14. 	1. Connect the Head FFC to the Print Head Connector and Main Board Connectors CN10, CN12, CN13, and CN14.
	Ink is not ejected from most nozzles.	Print Head	1. Check for occurrence of Head Hot.	1. Replace the Print Head with a new one.
			2. Check the Head FFC for damages.	2. Replace the Head FFC with a new one.

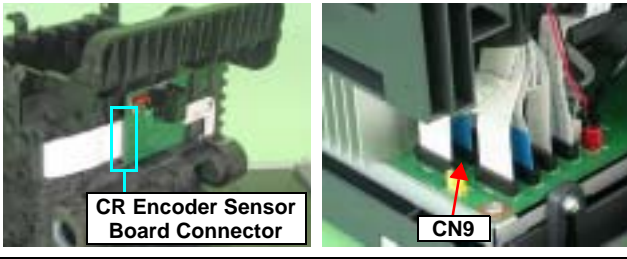
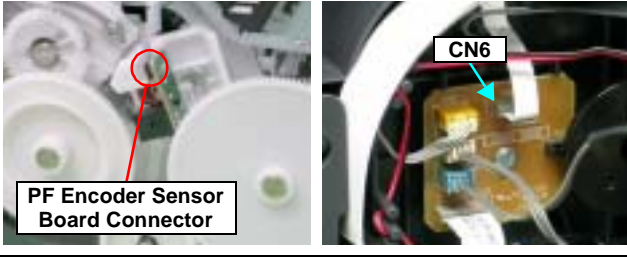
## 8.5 Exploded Diagram

---

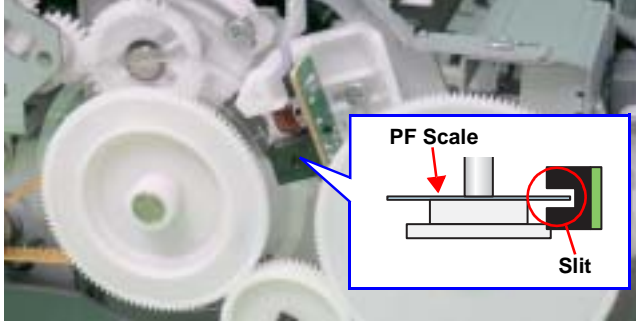
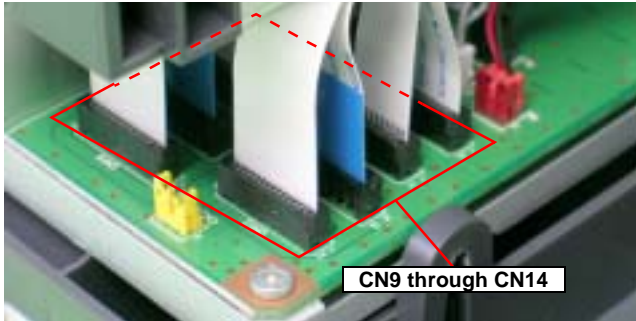
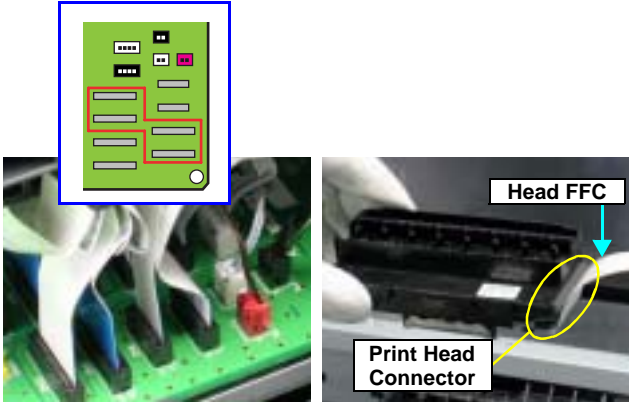
Following pages show exploded diagram.

- Exploded Diagram 1
- Exploded Diagram 2
- Exploded Diagram 3
- Exploded Diagram 4
- Exploded Diagram 5
- Exploded Diagram 6



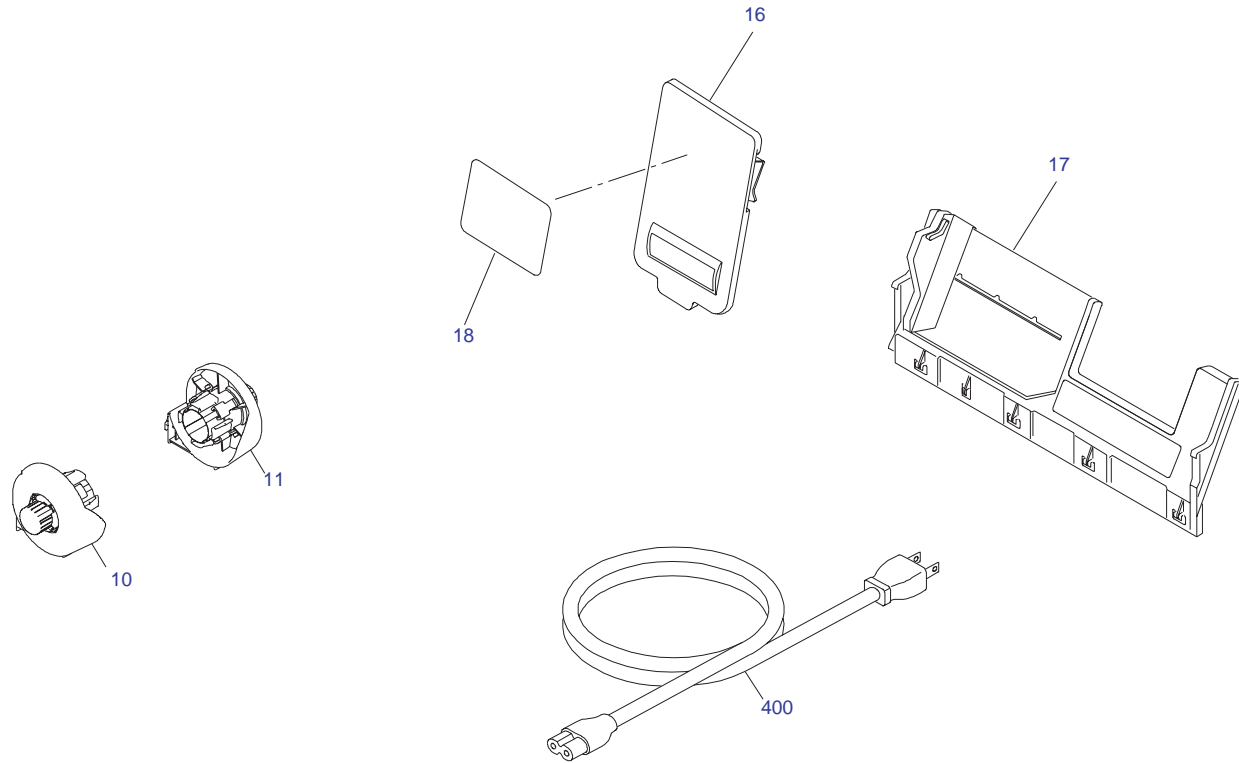

PX-5500 / EPSON STYLUS PHOTO R2400 No.1

Rev.01 C603-ACCE-001

Figure 8-3. Stylus Photo R2400 Exploded Diagram 1

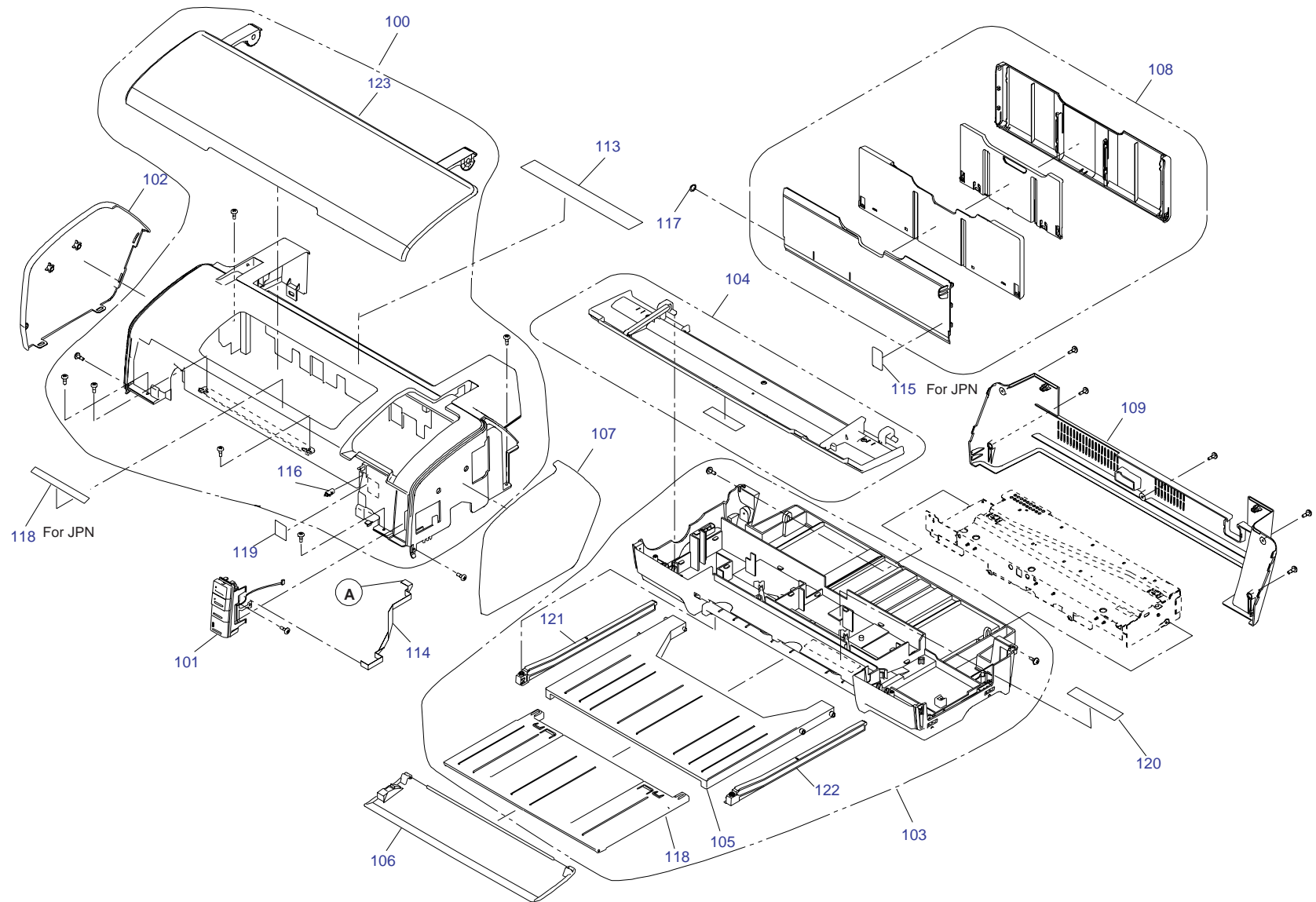

PX-5500 / EPSON STYLUS PHOTO R2400 No.2

Rev.01 C603-CASE-001

Figure 8-4. Stylus Photo R2400 Exploded Diagram 1

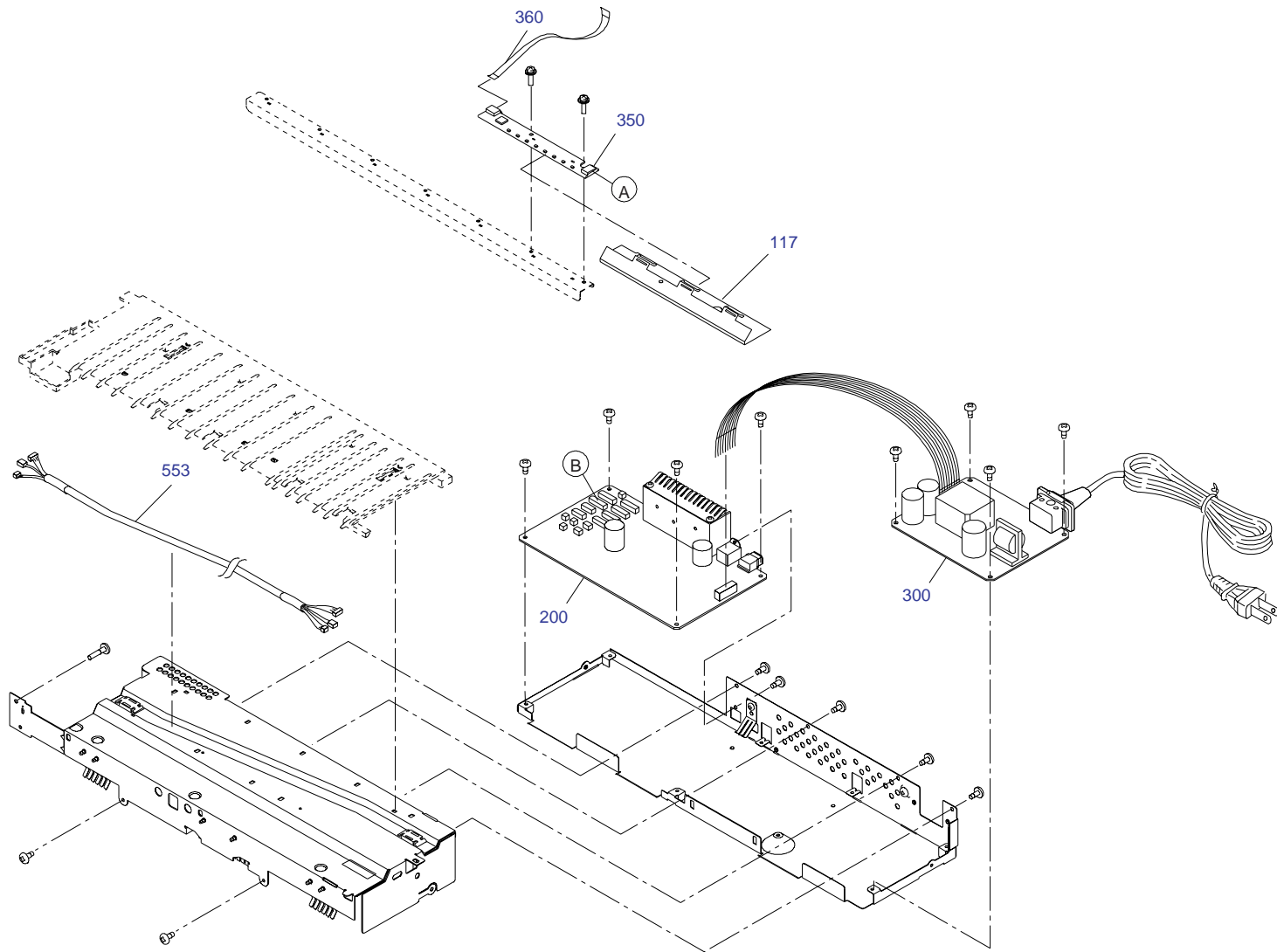

PX-5500 / EPSON STYLUS PHOTO R2400 No.3

Rev.01 C603-ELEC-001

Figure 8-5. Stylus Photo R2400 Exploded Diagram 1

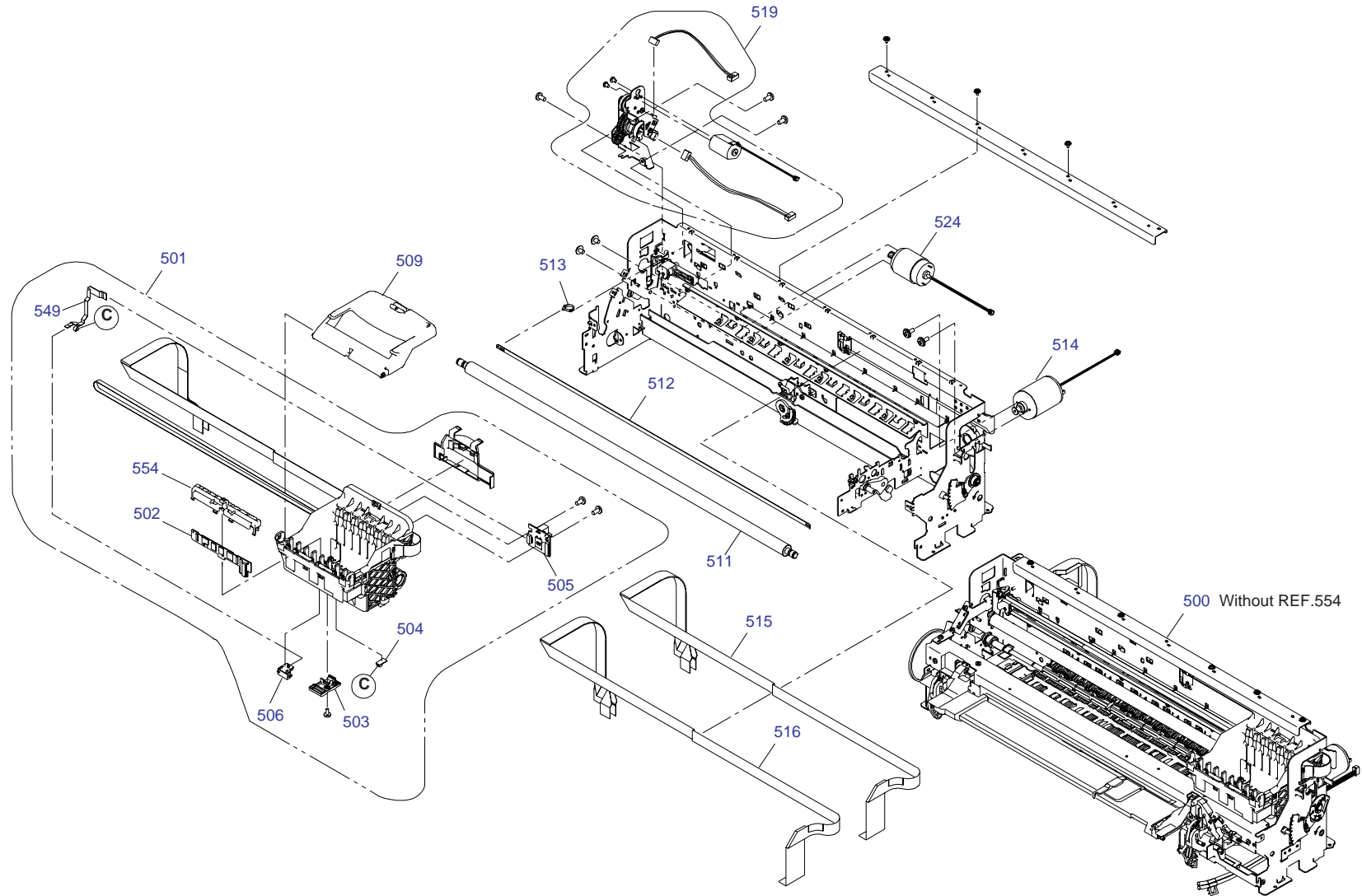

PX-5500 / EPSON STYLUS PHOTO R2400 No.4

Rev.01 C603-MECH-001

Figure 8-6. Stylus Photo R2400 Exploded Diagram 1

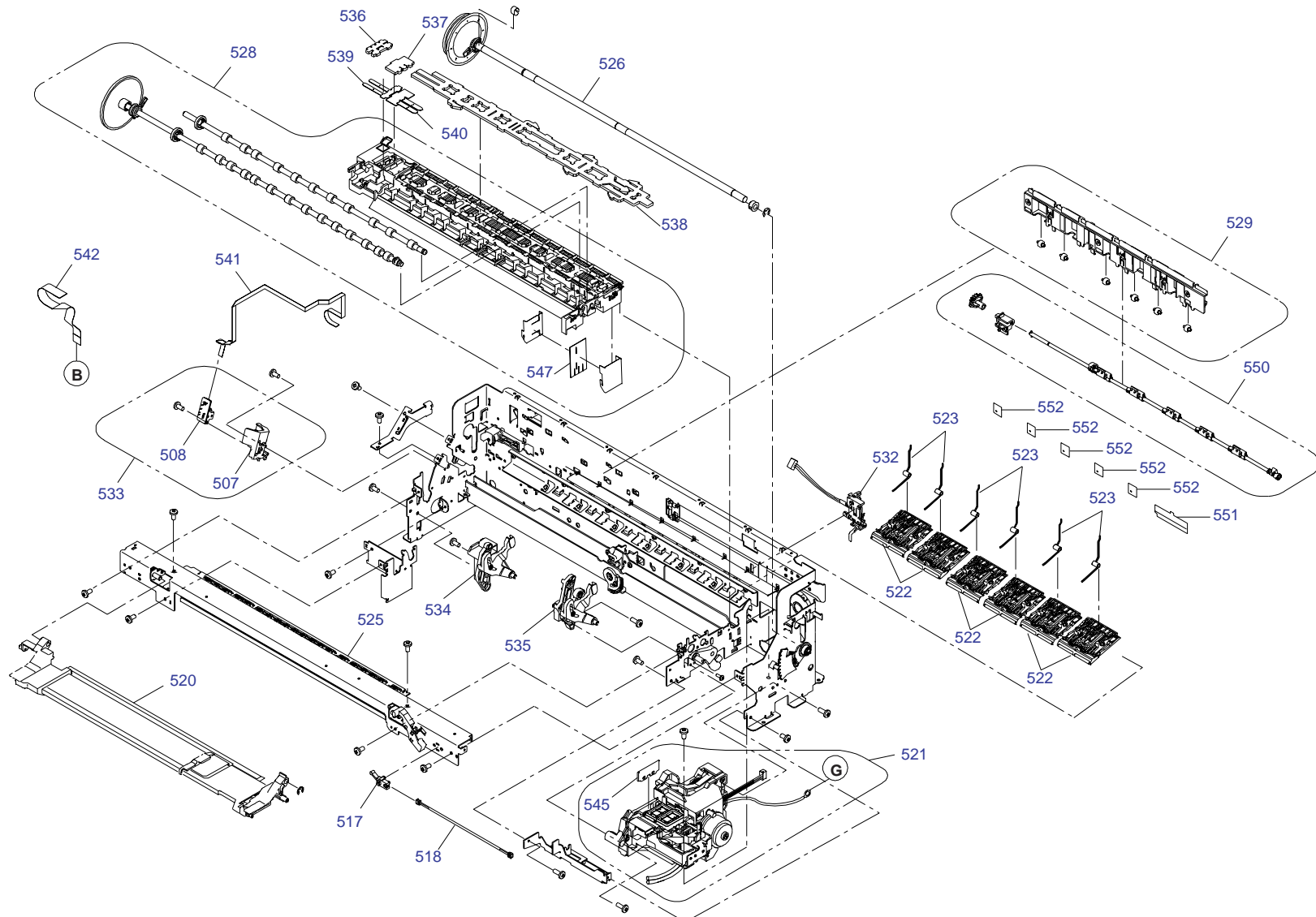

PX-5500 / EPSON STYLUS PHOTO R2400 No.5

Rev.01 C603-MECH-002

Figure 8-7. Stylus Photo R2400 Exploded Diagram 1

## 8.6 Parts List for EPSON Stylus Photo R2400

Table 8-17. Parts List for EPSON Stylus Photo R2400

Code	Parts Name
10	ROLL PAPER ASSY.,LEFT;B,ASP
11	ROLL PAPER ASSY.,RIGHT;B,ASP
16	MATTE PAPER SUPPORT ASSY.,ASP
17	PAPER SUPPORT USFAP ASSY.,ASP
18	LABEL,HOLDER MAT PAPER;B
100	HOUSING UPPER ASSY.,ASP
101	PANEL ASSY.,ASP
102	COVER,LEFT;EGM
103	HOUSING LOWER ASSY.,ASP
104	HOUSING CD-R ASSY.;B,ASP
105	STACKER
106	COVER STACKER ASSY.,ASP
107	COVER,RIGHT;EGM
108	PAPER SUPPORT ASSY.;B,ASP
109	HOUSING,REAR
113	LABEL,INSTRUCTION;B
116	MIN SIDE LOCK#091Y
118	STACKER,SUPPORT
120	LABEL,CAUTION ROLL PAPER
121	GIDE,STACKER,LEFT
122	GIDE,STACKER,RIGHT
123	COVER PRINTER ASSY.,ASP
721	LABEL,INK,POSITION;B
114	HARNESS
117	SHEET,LED
200	BOARD ASSY.,MAIN
350	BOARD ASSY.,PANEL
360	HARNESS
500	PRINTER MECHANISM ASP;ESL
501	CARRIAGE ASSY.;B,ASP

Table 8-17. Parts List for EPSON Stylus Photo R2400

Code	Parts Name
502	BOARD ASSY.,CSIC
503	HOLDER,DETECTOR,PW
504	BOARD ASSY.,INK MARK
505	BOARD ASSY.,ENCORDER,CR
506	BOARD ASSY.,DETECTOR,PW
507	HOLDER,BOARD ASSY.,ENCORDER,PF
508	BOARD ASSY.,ENCORDER,PF
509	COVER IC ASSY.,ASP
511	SHAFT,CR,GUIDE
512	SCALE,CR
513	TORSION SPRING,24.7
514	MOTOR ASSY.,CR
515	CABLE,HEAD,B
516	CABLE,HEAD
517	DETECTOR,LEAF,B2
518	HARNESS,DETECTOR,CD-R
519	AUTO PG ASSY.,ASP
520	TRAY PASTE BOARD BASE ASSY.,ASP
521	INK SYSTEM ASSY.;B,ASP
523	TORSION SPRING,PAPER GUIDE,UPPER
524	MOTOR ASSY.,PF
525	FRAME PAPER EJ ASSY ASP;ESL
526	ROLLER,PF ASSY.,ASP
528	PAPER GUIDE FRONT LOWER ASSY.,ASP;ESL
529	HOLDER RELEASE SUB ASSY.,ASP
532	PAPER DETECTOR ASSY.,ASP
533	PF ENCORDER ASSY ASP
534	RELEASE CD-R,LEFT ASSY.,ASP
535	RELEASE CD-R,RIGHT ASSY ASP; ESL
536	POROUS PAD,PAPER GUIDE,FRONT,LEFT,ASP
537	POROUS PAD,PAPER GUIDE,FRONT,CENTER,ASP
538	POROUS PAD,PAPER GUIDE,FRONT,ASP

Table 8-17. Parts List for EPSON Stylus Photo R2400

Code	Parts Name
539	POROUS PAD,GUIDE,INK EJECT LEFT
540	POROUS PAD,GUIDE,INK EJECT,CENTER
541	HARNESS,ENCORDER,PF
542	HARNESS,BOARD ASSY.,RELAY
545	CLEANER,HEAD;C,ASP
547	POROUS PAD,GUIDE,INK EJECT
549	CABLE,DETECTOR,8
550	FRAG RELEASE ASSY.,ASP
551	COVER,ROLLER,LD
552	COVER,ROLLER,LD
553	HARNESS,MOTOR
554	GUIDE,IC,OVER SEA
700	PRINT HEAD
701	ASF ASSY.,ASP
702	MOTOR,ASSY.,ASF
703	PAPER GUIDE,MANUAL
705	POROUS PAD,INK EJECT;LEFT;FA2
706	POROUS PAD,INK EJECT;LEFT;FB2
707	POROUS PAD,INK EJECT;LEFT;FC2
708	POROUS PAD,INK EJECT;LEFT;FD2
709	POROUS PAD,INK EJECT;LEFT;FE2
710	POROUS PAD,TUBE;FA2
711	POROUS PAD,TUBE;FB2
712	POROUS PAD,INK EJECT;RIGHT;FF2
713	POROUS PAD,INK EJECT;RIGHT;FG2
714	POROUS PAD,INK EJECT;RIGHT;FH2
715	POROUS PAD,INK EJECT;RIGHT;FI2
716	POROUS PAD,INK EJECT,IS,LEFT;B
717	POROUS PAD,INK EJECT,IS,LOWER,LEFT;B
718	POROUS PAD,INK EJECT,IS,LOWER;FB2
719	POROUS PAD,INK EJECT;H
720	POROUS PAD,CABLE,HEAD

Table 8-17. Parts List for EPSON Stylus Photo R2400

Code	Parts Name
722	LABEL,GUIDE,ROLL PAPER INSERT
723	LABEL,GUIDE,ROLL PAPER
724	CLAMP,TUBE
300	BOARD ASSY.,POWER SUPPLY