

# Main Board Electric Diagram for SD-280E: Vaddis\_SDRAM\_Flash

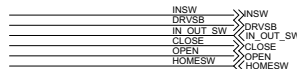

C32	D3	C42	B3	C25	C1	R20	A2	C19	D1	R85	B2	R23	D2
C21	D1	C43	B3	R15	A1	R22	B2	C20	D1	C24	C1	R23	C2
C27	D1	C44	B3	R17	A1	R140	A2	C26	D1	R31	A3	CE4	C3
C29	D2	C45	A4	R29	A2	R12	A2	R32	C3	R141	A2	L7	D1
C36	A3	C46	A4	D6	D2	R18	D1	R15	C1	R26	D2	L8	D1
C37	A3	C47	A4	C22	C1	XP5	D4	U3	B4	R24	D2	L9	D2
C38	A3	C48	B4	C23	C1	XP6	D4	CE3	D2	R25	D2	L10	B3
C39	A3	C49	B4	C28	B1	C34	A3	Y2	D2	R27	D2	U1	A2
C40	A3	C83	A4	C30	D2	R21	D2	C33	D3	CE2	D1	X3	A4
												U2A	B2
												TP1	A3

## Important power supply!

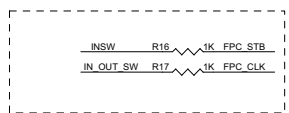
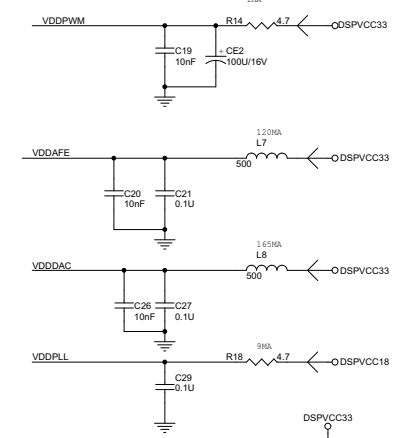

Close to Vaddis!

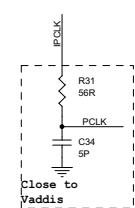
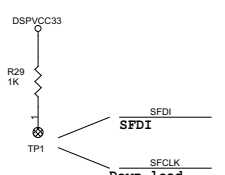
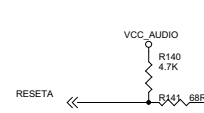
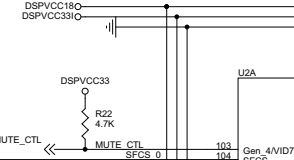
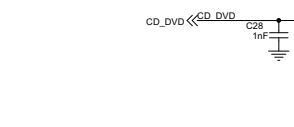
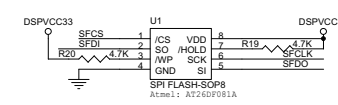
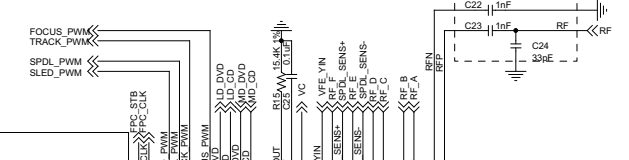

# ZORAN

## Vaddis-966XE/XF

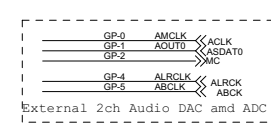
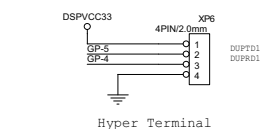
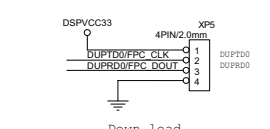
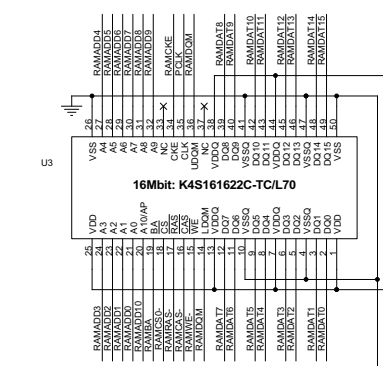
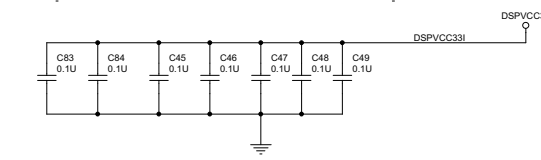
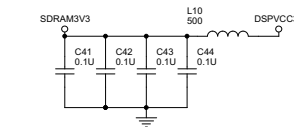
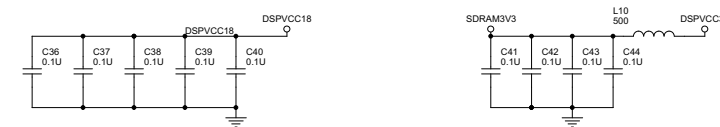
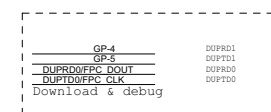
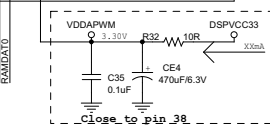
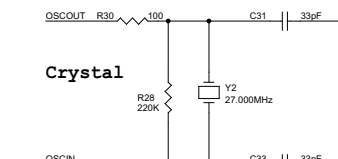
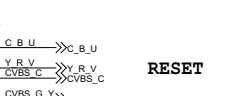
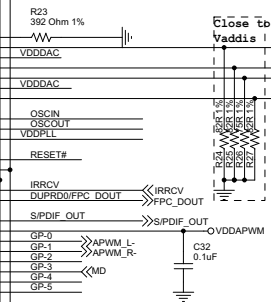
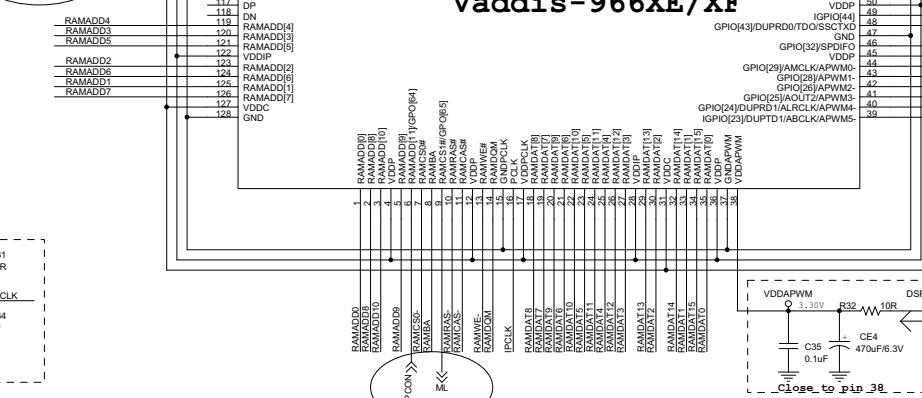

External 2ch Audio DAC amd ADC