

CONFIDENTIAL

SAMSUNG

TFT-LCD MONITOR

Chassis	Model
MO17P*	172T
MO17E*	172B

SERVICE Manual

TFT-LCD MONITOR

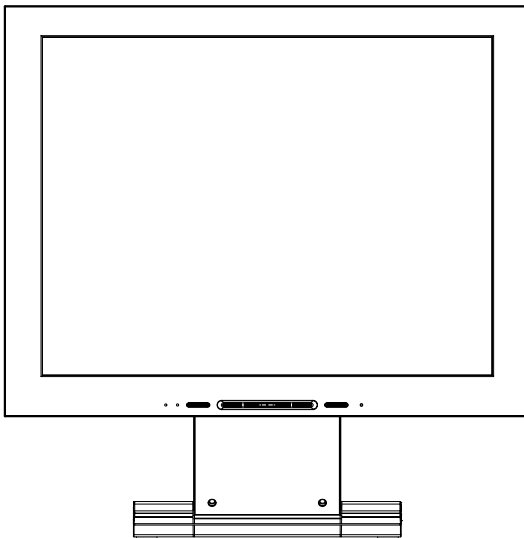

CONTENTS

1. Precautions
2. Product Specifications
3. Disassembly & Reassembly
4. Troubleshooting
5. Exploded View & Parts List
6. Electrical Parts List
7. Block Diagram
8. Wiring Diagram
9. Schematic Diagrams
10. Panel Description

1 Precautions

Follow these safety, servicing and ESD precautions to prevent damage and to protect against potential hazards such as electrical shock.

1-1 Safety Precautions

1-1-1 Warnings

1. For continued safety, do not attempt to modify the circuit board.
2. Disconnect the AC power and DC Power Jack before servicing.
3. When the chassis is operating, semiconductor heatsinks are potential shock hazards.

1-1-2 Servicing the LCD Monitor

1. When servicing the LCD Monitor, remove the static charge by connecting a 10k ohm resistor in series with an insulated wire (such as a test probe) between the chassis and the anode lead. (Disconnect the AC line cord from the AC outlet.)
2. It is essential that service technicians have an accurate voltage meter available at all times. Check the calibration of this meter periodically.

1-1-3 Fire and Shock Hazard

Before returning the monitor to the user, perform the following safety checks:

1. Inspect each lead dress to make certain that the leads are not pinched or that hardware is not lodged between the chassis and other metal parts in the monitor.
2. Inspect all protective devices such as nonmetallic control knobs, insulating materials, cabinet backs, adjustment and compartment covers or shields, isolation resistor-capacitor networks, mechanical insulators, etc.
3. Leakage Current Hot Check (Figure 1-1):
WARNING: Do not use an isolation transformer during this test.
 Use a leakage current tester or a metering system that complies with American National Standards Institute (*ANSI C101.1, Leakage Current for Appliances*), and Underwriters Laboratories (*UL Publication UL1410, 59.7*).

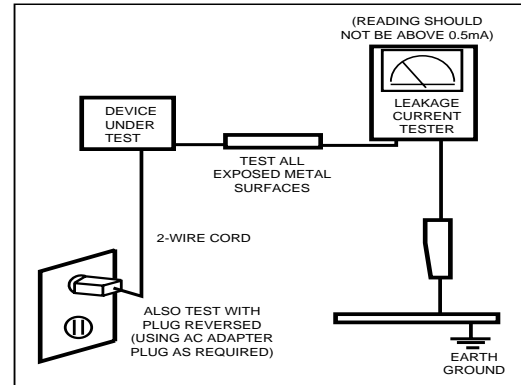

Figure 1-1. Leakage Current Test Circuit

4. With the unit completely reassembled, plug the AC line cord directly into a 120V AC outlet. With the unit's AC switch first in the ON position and then OFF, measure the current between a known earth ground (metal water pipe, conduit, etc.) and all exposed metal parts, including: metal cabinets, screwheads and control shafts. The current measured should not exceed 0.5 milliamp. Reverse the power-plug prongs in the AC outlet and repeat the test.

1-1-4 Product Safety Notices

Some electrical and mechanical parts have special safety-related characteristics which are often not evident from visual inspection. The protection they give may not be obtained by replacing them with components rated for higher voltage, wattage, etc. Parts that have special safety characteristics are identified by on schematics and parts lists. A substitute replacement that does not have the same safety characteristics as the recommended replacement part might create shock, fire and / or other hazards. Product safety is under review continuously and new instructions are issued whenever appropriate.

2 Product Specifications

2-1 Specifications

Item	Description	
	Analog	Digital
LCD Panel	TFT-LCD panel, RGB vertical stripe, normally white transmissive, 17-Inch viewable, 0.264 pixel pitch	
Scanning Frequency	Horizontal : 30 kHz ~ 81 kHz (Automatic) Vertical : 56 Hz ~ 75 Hz	
Display Colors	16,2 Million colors	
Maximum Resolution	Horizontal : 1280 Pixels @ 81 kHz Vertical : 1024 Pixels @ 75 Hz	
Input Video Signal	Analog, 0.7 Vp-p ± 5% positive at 75 Ω, internally terminated	TMDS
Input Sync Signal	Type : Seperate H/V sync., In case of using option cable, Composite, Automatic Synchronization without external switch Level : TTL level (V high ≥ 2.0 V, V low ≤ 0.8 V)	
Maximum Pixel Clock rate	135 MHz	
Active Display Horizontal/Vertical	337.92 ± 92 mm 270.336 ± 3 mm	
AC power voltage & Frequency	AC 90 ~ 264 Volts, 60/50 Hz ± 3 Hz	
Power Consumption	42 W (max), 35 W (normal)	
Dimensions Unit (W x D x H)	385 x 216 x 396.3 mm (15.2 x 8.5 x 15.6 inches) / After installation of stand	
Carton (W x D x H)	385 x 56.8 x 324.7 mm (15.2 x 2.2 x 12.8 inches) / After folding the stand 468 x 400 x 145 mm (18.4 x 15.7 x 5.7 inches)	
Weight (Net/Gross) Normal stand Multi stand	4.7 kg (10.4 lbs) / 6.8 kg (15.0 lbs) 4.8 kg (10.6 lbs) / 6.9 kg (15.2 lbs)	
Environmental Considerations	Operating Temperature : 41°F ~ 95°F (5°C ~ 35°C) Humidity : 10 % ~ 80 % Storage Temperature : -4°F ~ 113°F (-20°C ~ 45°C) Humidity : 5 % ~ 95 %	
<ul style="list-style-type: none"> • M017P*/M017E* comply with TC099 recommendations for reduced electromagnetic fields. • Designs and specifications are subject to change without prior notice. 		

3 Disassembly and Reassembly

This section of the service manual describes the disassembly and reassembly procedures for the MO17P*/MO17E* monitors.

WARNING: This monitor contains electrostatically sensitive devices. Use caution when handling these components.

3-1 Disassembly

- Cautions:**
1. Disconnect the monitor from the power source before disassembly.
 2. Follow these directions carefully; never use metal instruments to pry apart the cabinet.

3-1-1 Main Body Disassembly



1. Locate the monitor on the table with face down.

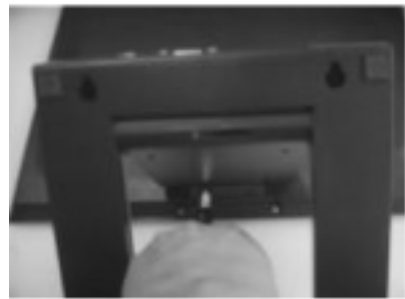

2. Loosen the snaps of Hinge cap through the slot of cover rear.



3. Remove the hinge cap.

4 Troubleshooting

Notes: 1. Before troubleshooting, setup the PC's display as below.

- Resolution: 1280 x 1024
- H-frequency: 64 kHz
- V-frequency: 60 Hz

2. If no picture appears, make sure the power cord is correctly connected.

3. Check the following circuits.

- No raster appears: Stand PCB, Main PCB
- 14V develop but no screen: Main PCB
- 14V does not develop: Main PCB

4. If you push and hold the Exit for more than 5 seconds, the monitor automatically turns back to the factory preset.

4-1 No Power

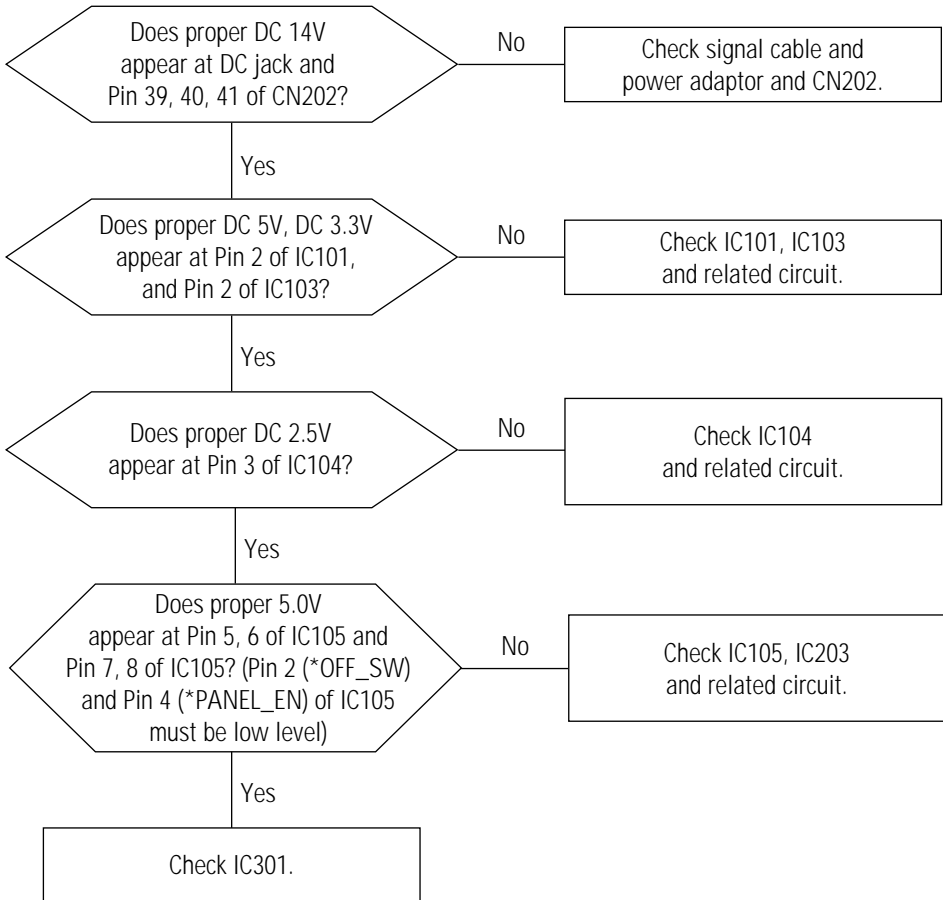

5 Exploded View and Parts List

No.	DESCRIPTION	CODE No.	SPECIFICATION	Q'ty	REMARK
1	ASSY, COVER-FRONT	BN96-00102A(M017PS)	ABS HB GR07	1	SA
		BN96-00102B(M017ES)			
2	PANEL	-	M017PS, EU, E6	1	-
3	SUB PCB	-	M017PS	1	-
4	MAIN PCB	-	M017PS	1	-
5	SHIELD CONNECTOR	BN63-00353A	SPTF T0.3	1	SNA
6	SCREW-MACHINE	6001-000125	BH, +, M3, L4,	5	SA
7	ASSY, SHIELD-PCB	BN96-00103A	SECC T1.0	1	SNA
8	SCREW-TAPTITE	6003-000269	BH, +, S, M3, L6	4	SA
9	SCREW-TAPTITE	6003-000282	BH, +, B, M3, L8, ZPC(BLK)	4	SA
10	ASSY COVER-REAR	BN96-00143A	ABS HB BK07	1	SA
11	SCREW-TAPTITE	6003-000282	BH, +, B, M3, L8, ZPC(BLK)	2	SA
12	ASSY, STAND	BN96-00104A(M017PS)	ANS HB BK07	1	SA
		BN96-00104B(M017ES)			
13	SHIELD-CONNECTOR	BN63-00353A	SPTF T0.3	1	SNA
14	SCREW-MACHINE	6003-000133	BH, +, S, M4, L8	2	SA
15	CAP-STAND	BN72-00310A	ABS HB BK07	1	SNA
16	SCREW-TAPTITE	-	CH, +, M2.0, L3.0	2	

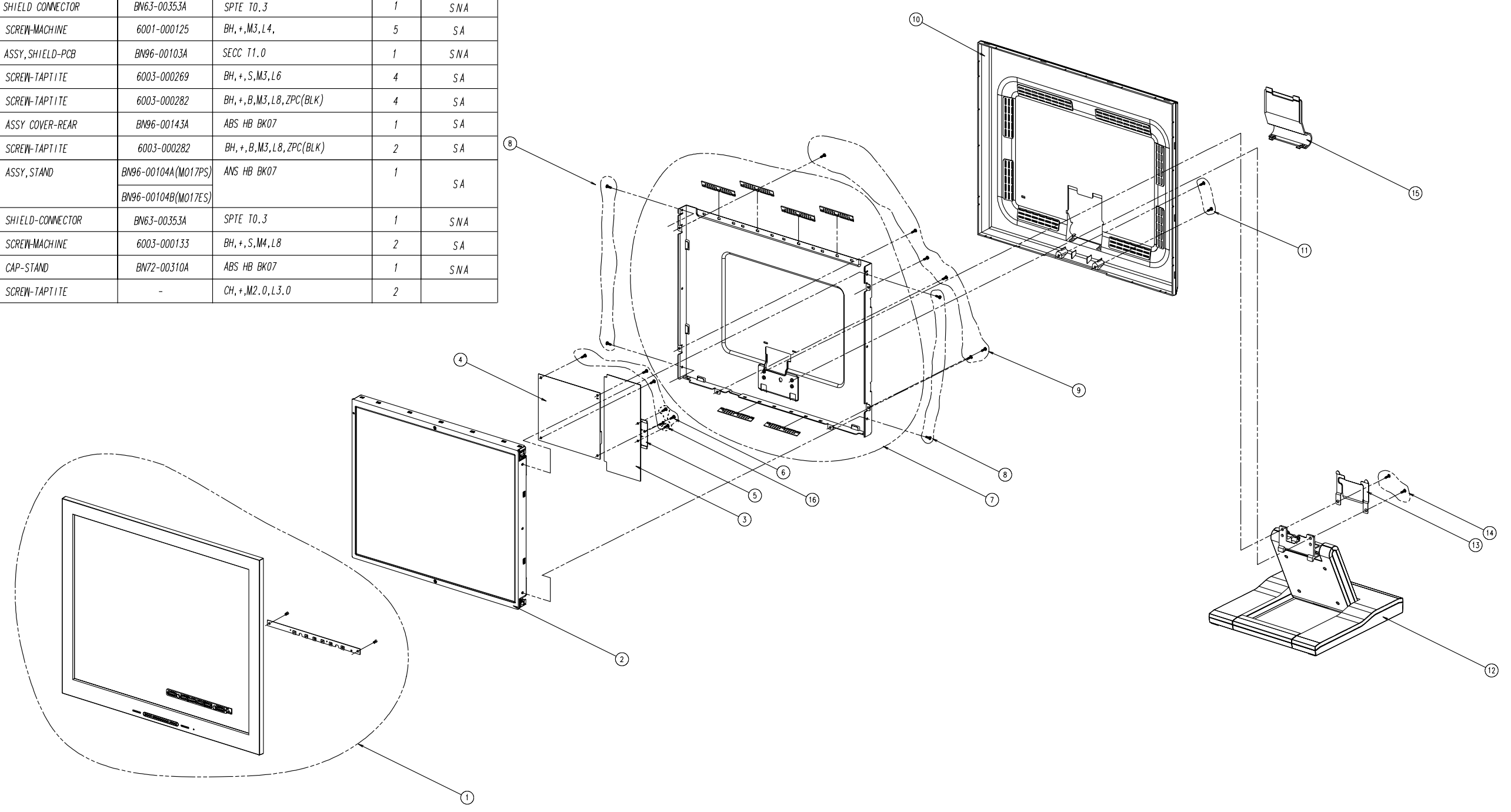

6 Electrical Parts List

6-1-1 M017P* Main PCB Parts

Loc. No.	Code No.	Description	Specification	Remarks
-	BN94-00356A	ASSY PCB MAIN	M017PS	SNA
CIS1	0201-001223	ADHESIVE-TS	HT-130S,RED,700+/- 50,-	SNA
CIS2	0202-001044	SOLDER-WIRE.	S63S-W3.0,S63S,D3,63Sn/37Pb,-	SNA
CIS4	0202-001046	SOLDER-WIRE FLUX	CF-110VH-2A,-,-,-,-	SNA
CIS5	0202-001162	SOLDER-CREAM	RMA-20-21L,S63,-,SN63/PB36.6/AG0.4,FLUX9.5%	SNA
CIS6	0202-001222	SOLDER-WIRE FLUX	RS-107,RS60-1.2AA,D1.2,SN60/PB40,-	SNA
CIS7	0204-001095	THINNER	#4520,-,-,-	SNA
CIS3	BN39-00002A	CBF-HARNESS	-.60,BLU/WHT,-,-26,-	SNA
CIS11	BN63-00433A	GASKET	M017PS,CONDUCTIVE FABRIC,2MM,10MM,10MM,GRAY,71TSSK 10-2-10-13,71TSSK 10-2-10-13	
CIS10	BN63-00435A	GASKET	M017PS,CONDUCTIVE FABRIC,2MM,4MM,40MM,GRAY,71TSSK 4-2-40-13,71TSSK 4-2-40-13	
CIS9	BN97-00115R	ASSY MICOM	M017PS	
IC302	1102-001097	IC-EPROM	27C010,128KX8BIT,PLCC,32P,-,90NS,5V,10%,PLASTIC,OTO+70C,0.1MA,CMOS,TR	
CIS	BN46-00014M	S/W MICOM-S/W	M017PS	SNA
-	BN97-00143A	ASSY SMD	M017PS	SNA
C102	2203-005005	C-CERAMIC,CHIP	100nF,10%,16V,X7R,TP,1608	
C103	2203-005005	C-CERAMIC,CHIP	100nF,10%,16V,X7R,TP,1608	
C106	2409-001065	C-ORGANIC	82UF,20%,16V,WT,TP,8X6.9MM,-	
C108	2203-005005	C-CERAMIC,CHIP	100nF,10%,16V,X7R,TP,1608	
C109	2409-001051	C-ORGANIC	82UF,20%,6.3V,WT,TP,6.3*5.9MM,2.1	
C110	2203-005005	C-CERAMIC,CHIP	100nF,10%,16V,X7R,TP,1608	
C111	2203-005005	C-CERAMIC,CHIP	100nF,10%,16V,X7R,TP,1608	
C112	2203-005005	C-CERAMIC,CHIP	100nF,10%,16V,X7R,TP,1608	
C113	2203-005005	C-CERAMIC,CHIP	100nF,10%,16V,X7R,TP,1608	
C114	2203-005005	C-CERAMIC,CHIP	100nF,10%,16V,X7R,TP,1608	
C118	2402-000135	C-AL,SMD	22uF,20%,16V,GP,TP,5.3x5.3x5.4	
C119	2203-005005	C-CERAMIC,CHIP	100nF,10%,16V,X7R,TP,1608	
C120	2203-005005	C-CERAMIC,CHIP	100nF,10%,16V,X7R,TP,1608	
C121	2203-005005	C-CERAMIC,CHIP	100nF,10%,16V,X7R,TP,1608	
C122	2203-005005	C-CERAMIC,CHIP	100nF,10%,16V,X7R,TP,1608	
C123	2203-005005	C-CERAMIC,CHIP	100nF,10%,16V,X7R,TP,1608	
C124	2203-005005	C-CERAMIC,CHIP	100nF,10%,16V,X7R,TP,1608	
C125	2203-005005	C-CERAMIC,CHIP	100nF,10%,16V,X7R,TP,1608	
C126	2203-005005	C-CERAMIC,CHIP	100nF,10%,16V,X7R,TP,1608	
C127	2203-005005	C-CERAMIC,CHIP	100nF,10%,16V,X7R,TP,1608	
C128	2203-005005	C-CERAMIC,CHIP	100nF,10%,16V,X7R,TP,1608	
C129	2203-005005	C-CERAMIC,CHIP	100nF,10%,16V,X7R,TP,1608	
C130	2203-005005	C-CERAMIC,CHIP	100nF,10%,16V,X7R,TP,1608	
C131	2203-005005	C-CERAMIC,CHIP	100nF,10%,16V,X7R,TP,1608	
C133	2203-001607	C-CERAMIC,CHIP	0.22nF,5%,50V,NP0,TP,1608	
C134	2203-001607	C-CERAMIC,CHIP	0.22nF,5%,50V,NP0,TP,1608	
C135	2203-001607	C-CERAMIC,CHIP	0.22nF,5%,50V,NP0,TP,1608	
C136	2203-001607	C-CERAMIC,CHIP	0.22nF,5%,50V,NP0,TP,1608	
C137	2203-001607	C-CERAMIC,CHIP	0.22nF,5%,50V,NP0,TP,1608	
C138	2402-000135	C-AL,SMD	22uF,20%,16V,GP,TP,5.3x5.3x5.4	
C139	2203-005005	C-CERAMIC,CHIP	100nF,10%,16V,X7R,TP,1608	
C140	2203-005005	C-CERAMIC,CHIP	100nF,10%,16V,X7R,TP,1608	
C141	2203-005005	C-CERAMIC,CHIP	100nF,10%,16V,X7R,TP,1608	
C142	2203-005005	C-CERAMIC,CHIP	100nF,10%,16V,X7R,TP,1608	
C143	2203-005005	C-CERAMIC,CHIP	100nF,10%,16V,X7R,TP,1608	
C144	2203-005005	C-CERAMIC,CHIP	100nF,10%,16V,X7R,TP,1608	

7 Block Diagram

7-1 M017P*

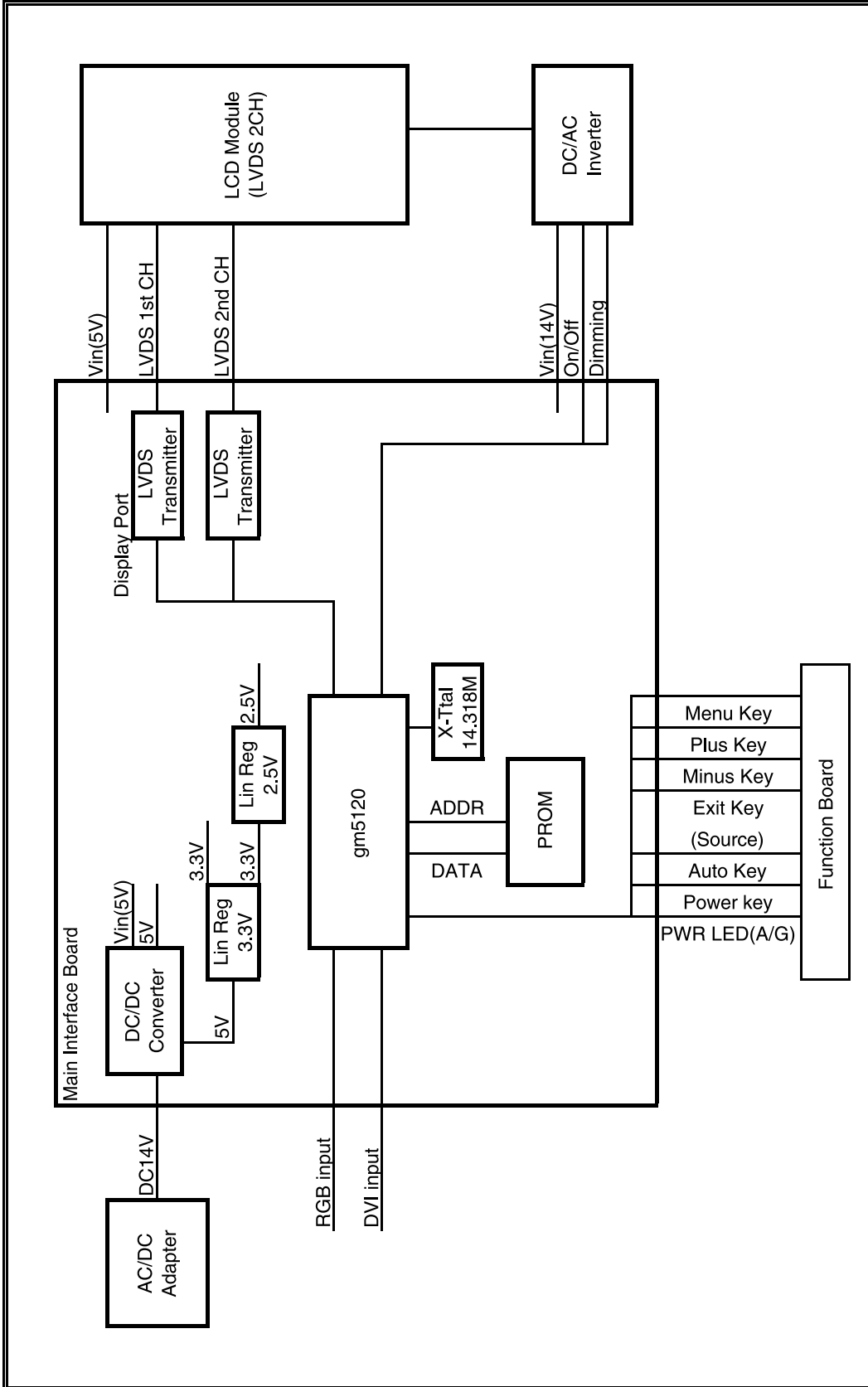

8 Wiring Diagram

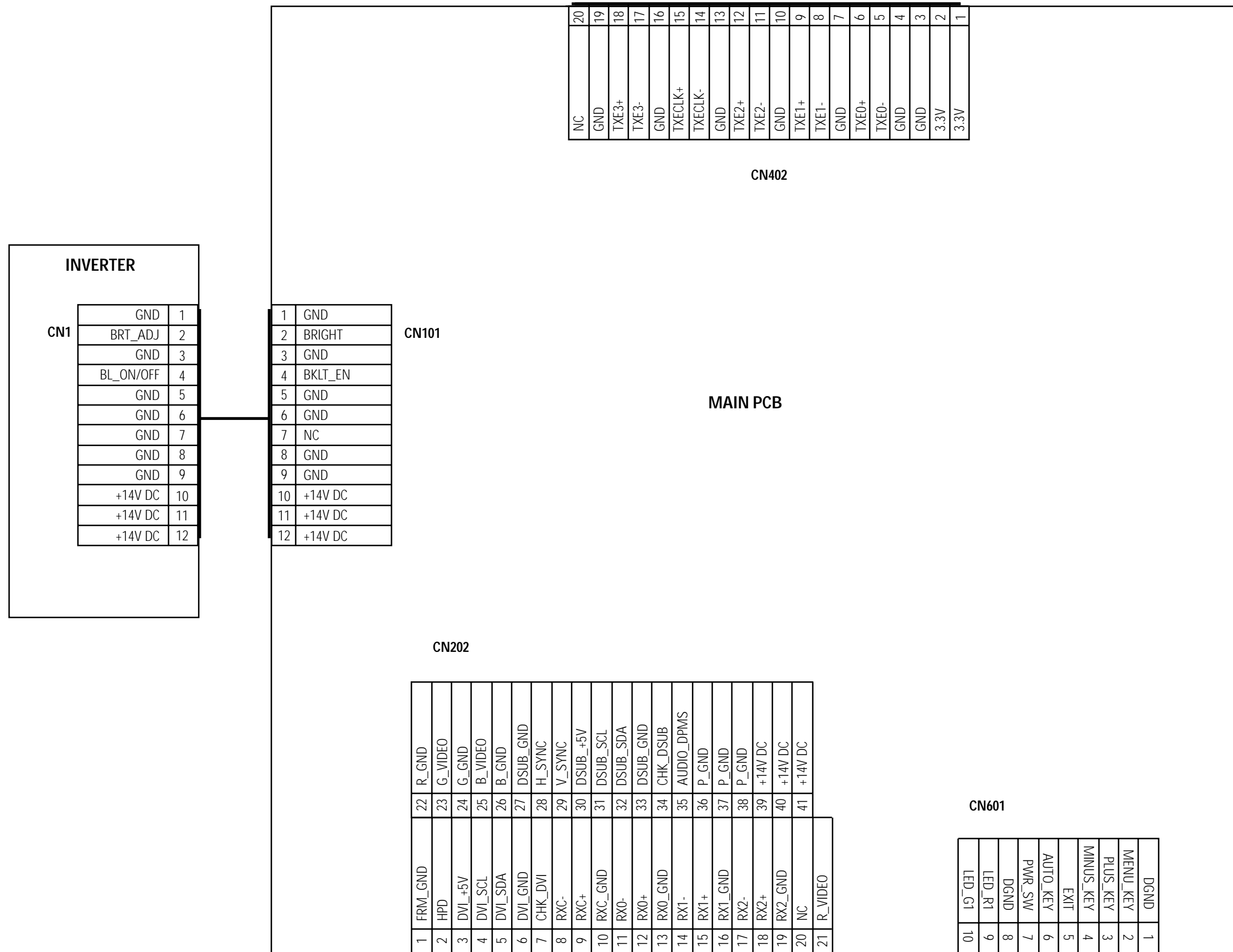

9 Schematic Diagrams

9-1 Schematic Diagram

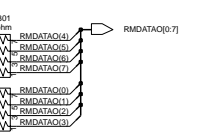
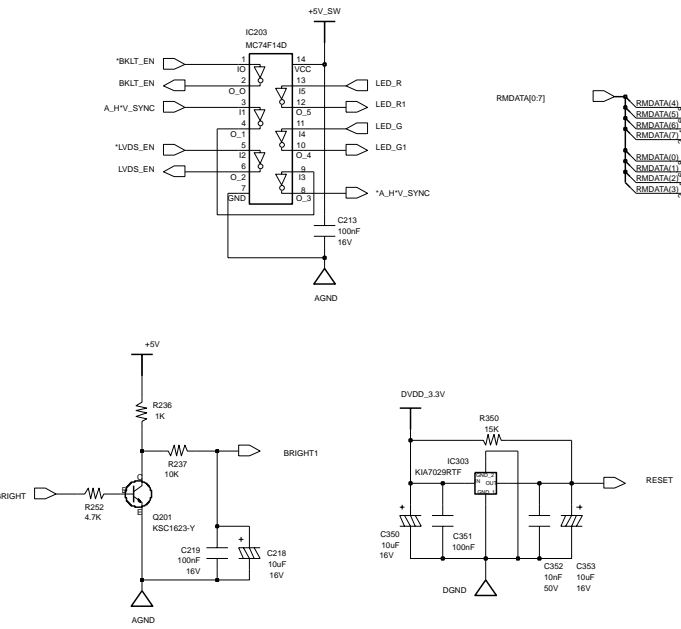
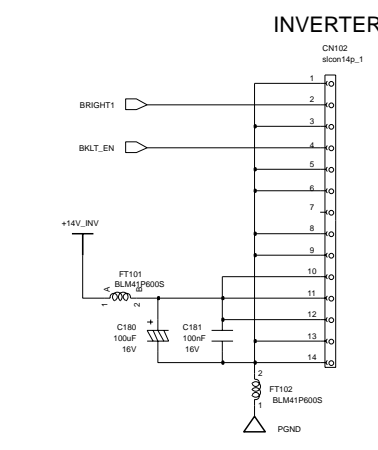
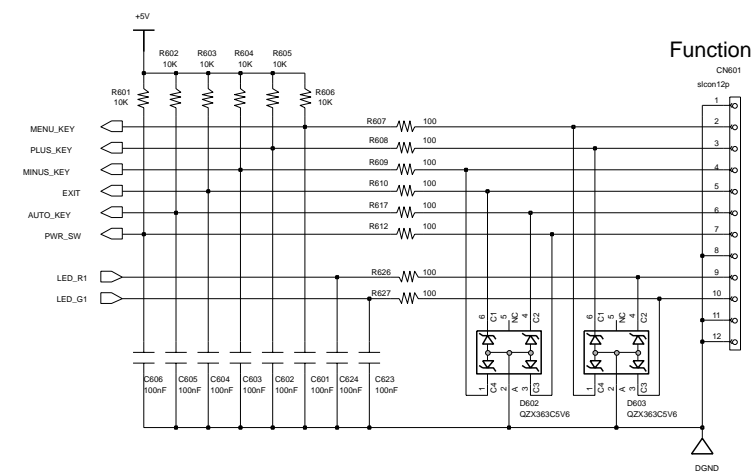
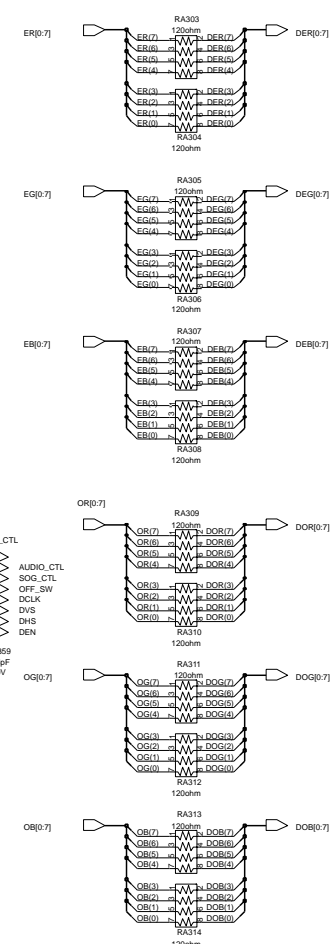
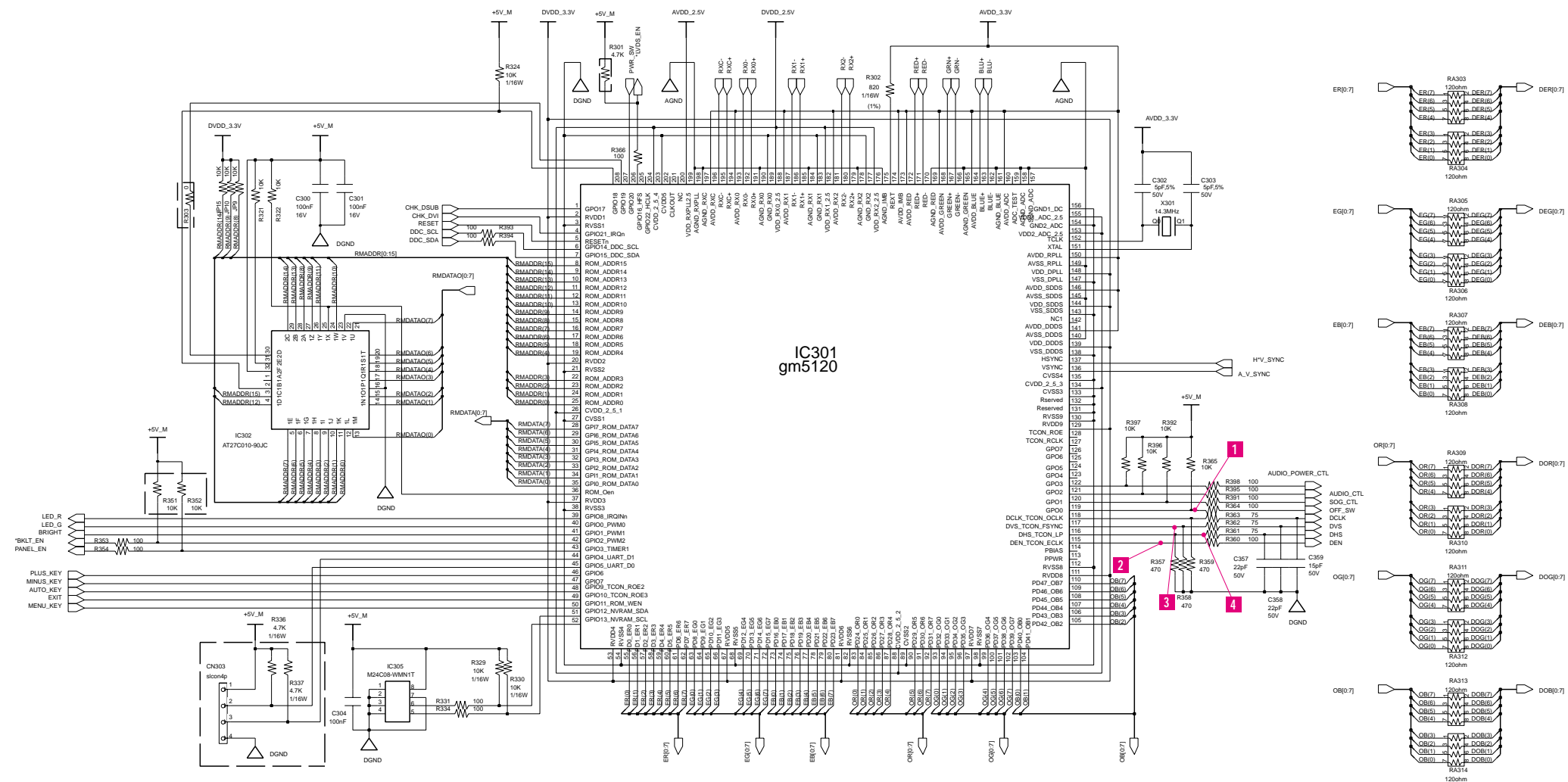

10 Panel Description

Maker	VENDOR P/N	PANEL_CODE	PANEL_ABB	STICKER_CODE	Remarks
SEC	LT140X1-002	BN07-00004A	SA	BN68-00187A	
SEC	LT150XS-L01	BN07-00009A	SB	BN68-00187B	
SEC	LT150XS-L01-B	BN07-00022A	SC	BN68-00187C	
SEC	LTM150XS-L02	BN07-00005A	SD	BN68-00187D	
SEC	LT181E2-132	BN07-00001A	SE	BN68-00187E	
SEC	LT150XS-T01	BN07-00010A	SF	BN68-00187F	
SEC	LTM181E3-132	BN07-00019A	SG	BN68-00187G	
SEC	LT170E2-131	BN07-10001D	SH	BN68-00187H	
SEC	LT181E2-131	BN07-10001E	SJ	BN68-00187J	
SEC	LTM170E4-L01	BN07-00018A	SK	BN68-00187K	
SEC	LTM240W1-L01	BN07-00015A	SL	BN68-00187L	
SEC	LTM213U3-L01	BN07-00016A	SM	BN68-00187M	
SEC	LTM150XH-L01	BN07-00026A	SN	BN68-00187W	
SEC	LTM150XH-L03	BN07-00027A	SP	BN68-00187X	
SEC	LTM150XS-L01	BN07-00032A	SQ	BN68-00195B	DELL(ZPD)
SEC	LTM181E4-L01	BN07-00034A	SR	BN68-00195C	PVA
SEC	LTM170EH-L01	BN07-00036A	SS	BN68-00195D	TN
SEC	LTM170E5-L01	BN07-00037A	SU	BN68-00195E	PVA
SEC	LTM150XH-L11	BN07-00041A	SV	BN68-00195G	
SEC	LTM213U4-L01	BN07-00039A	SW	BN68-00195L	PVA
SEC	LTM150XH-L01(ZPD)	BN07-00045A	SX	BN68-00195M	ZPD
SEC	LTM150XH-L04	BN07-00046A	SY	BN68-00195N	PANEL
SEC	LTM170W1-L01	BN07-00047A	SZ	BN68-00195P	TV PANEL
SEC	LTM150XH-L06	BN07-00053A	EA	BN68-00195V	TV PANEL/450cd _Sony& EOS TV panel
SEC	LTM153W1-L01	BN07-00054A	EB	BN68-00195W	NIKE MODEL
SEC	LTM170EH-L05	BN07-00055A	EC	BN68-00195X	17"EH-L05 panel EOS proj.
SEC	LTM170E5-L03	BN07-00056A	ED	BN68-00195Y	Dell 1702FP pro. E4. EH Compatible
SEC	LTM190E1-L01	BN07-00057A	EE	BN68-00195Z	DELL 1900 FP
SEC	LTM181E5-L01	BN07-00061A	EF	BN68-00239C	18" narrow bezel GH18PS
SEC	LTM150XP-L01	BN07-00065A	EG	BN68-00239F	AMLCD PVA PANEL
SEC	LTM240W1-L02	BN07-00062A	EH	BN68-00239G	15"Wide tv panel
SEC	LTM170EU-L01	BN07-00071A	EJ		Slim design, TN
SEC	LTM170E5-L04	BN07-00072A	EK		E5-L04 6 bits FRC... for IBM
TOSHIBA	LTM15C419(A)	BN07-00002A	TA	BN68-00187N	
TOSHIBA	LTM15C423(B)	BN07-00006A	TB	BN68-00187P	
TOSHIBA	LTM18C161	BN07-00008A	TC	BN68-00187U	
TOSHIBA	LTM15C443	BN07-00031A	TD	BN68-00195A	
TOSHIBA	LTM15C458	BN07-00043A	TE	BN68-00195H	
HANNSTAR	HSD150MX41A(A)	BN07-00020A	NA	BN68-00187Q	TTL
HANNSTAR	HSD150MX12	BN07-00030A	NB	BN68-00187Y	LVDS
TORISAN	TM150XG-22L03(A)	BN07-00021A	RA	BN68-00187R	
TORISAN	TM150XG-26L06	BN07-00042A	RB	BN68-00195J	
TORISAN	TM181SX-76N01	BN07-00048A	RC	BN68-00195Q	
TORISAN	TM150XG-22L06	BN07-00059A	RD	BN68-00239A	15" XGA TN MODE(ZPD)
TORISAN	TM290WX-71N31	BN07-00063A	RE	BN68-00239D	RS24NS (TORISAN 29" PANEL)
TORISAN	TM396WX-71N31	BN07-00064A	RF	BN68-00239E	RS24NS (TORISAN 40" PANEL)
SHARP	LQ181E1DG11(A)	BN07-10001C	PA	BN68-00187S	
SHARP	LQ150X1LW71	BN07-00067A	PB		SHARP 15" PVA PANEL
HITACHI	TX38D12VCOCAA(A)	BN07-00003A	HA	BN68-00187T	
HITACHI	TX43DVCOCAB	BN07-00060A	HB	BN68-00239B	17" SXGA PVA MODE"
IBMITX94S	BN07-00017A		IA	BN68-00187V	
UNIPAC	UM170E0	BN07-00028A	UA	BN68-00187Z	
HYUNDAI	HT15X13	BN07-00035A	DA	BN68-00195F	
HYUNDAI	HT17E11-200	BN07-00049A	DB	BN68-00195R	TN MODE
ACERL170E3	BN07-00044A		AA	BN68-00195K	TN(ADT)
CHIMEI	M170E3-L01	BN07-00050A	CA	BN68-00195S	TN PANEL
CHIMEI	M150X3-L01	BN07-00051A	CB	BN68-00195T	COMPATIBLE
CHIMEI	M170E4-L01	BN07-00052A	CC	BN68-00195U	MVA PANEL
CHIMEI	M150X2-L01	BN07-00066A	CD		CHIME 15" I PVA PANEL

Copyright

© 2002 by Samsung Electronics Co., Ltd.

All rights reserved.

This manual may not, in whole or in part, be copied, photocopied, reproduced, translated, or converted to any electronic or machine readable form without prior written permission of Samsung Electronics Co., Ltd.

MO17P*/MO17E* Service Manual

First edition July 2002.

Printed in Korea.

Trademarks

Samsung is the registered trademark of Samsung Electronics Co., Ltd.

MO17P*/MO17E* and Macmaster Cable Adapter are trademarks of Samsung Electronics Co., Ltd.

Macintosh, Centris, Quadra, Duo Douk, and Power Macintosh are trademarks of Apple Computer, Inc.

All other trademarks are the property of their respective owners.

Memo

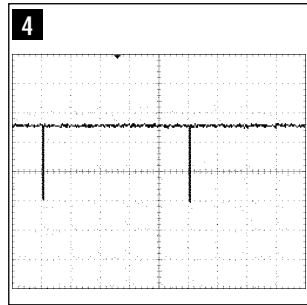
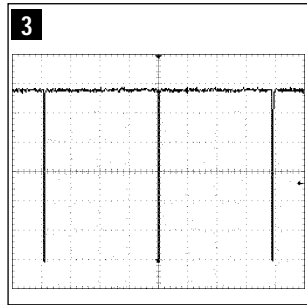
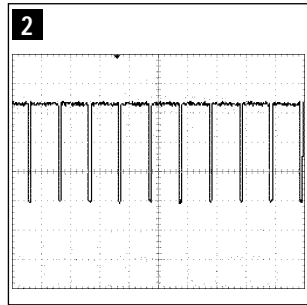
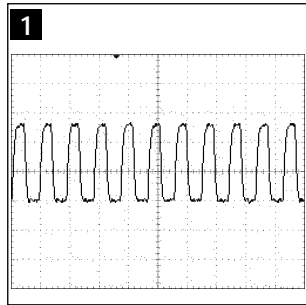

9-2 Schematic Diagram

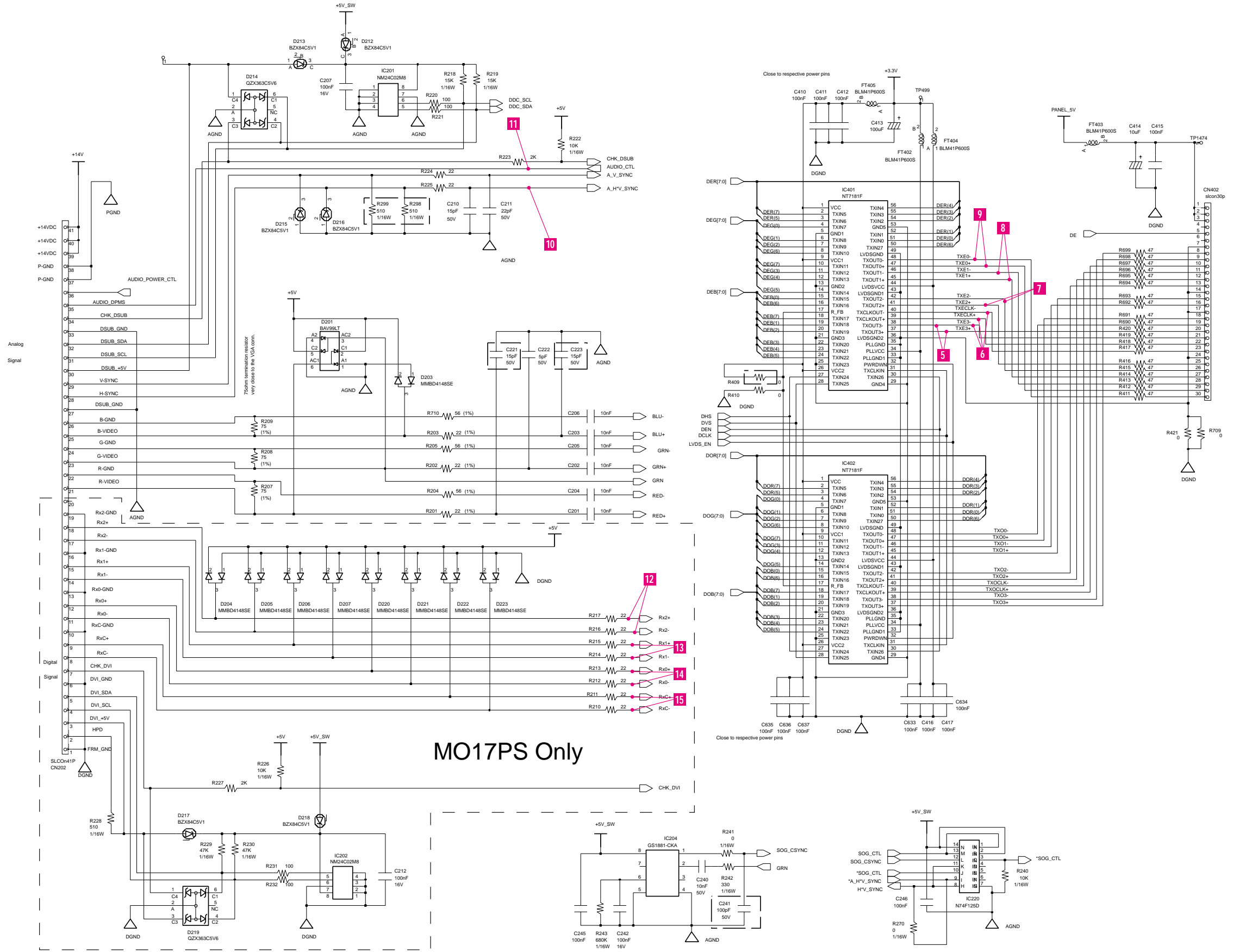

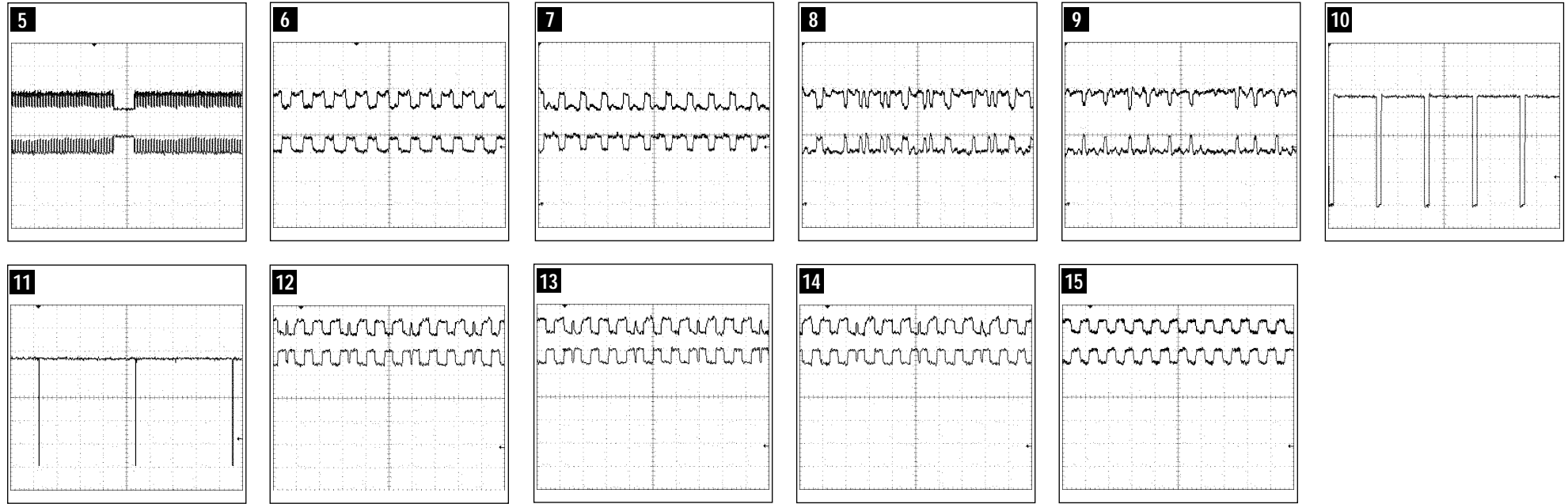

9-3 Schematic Diagram

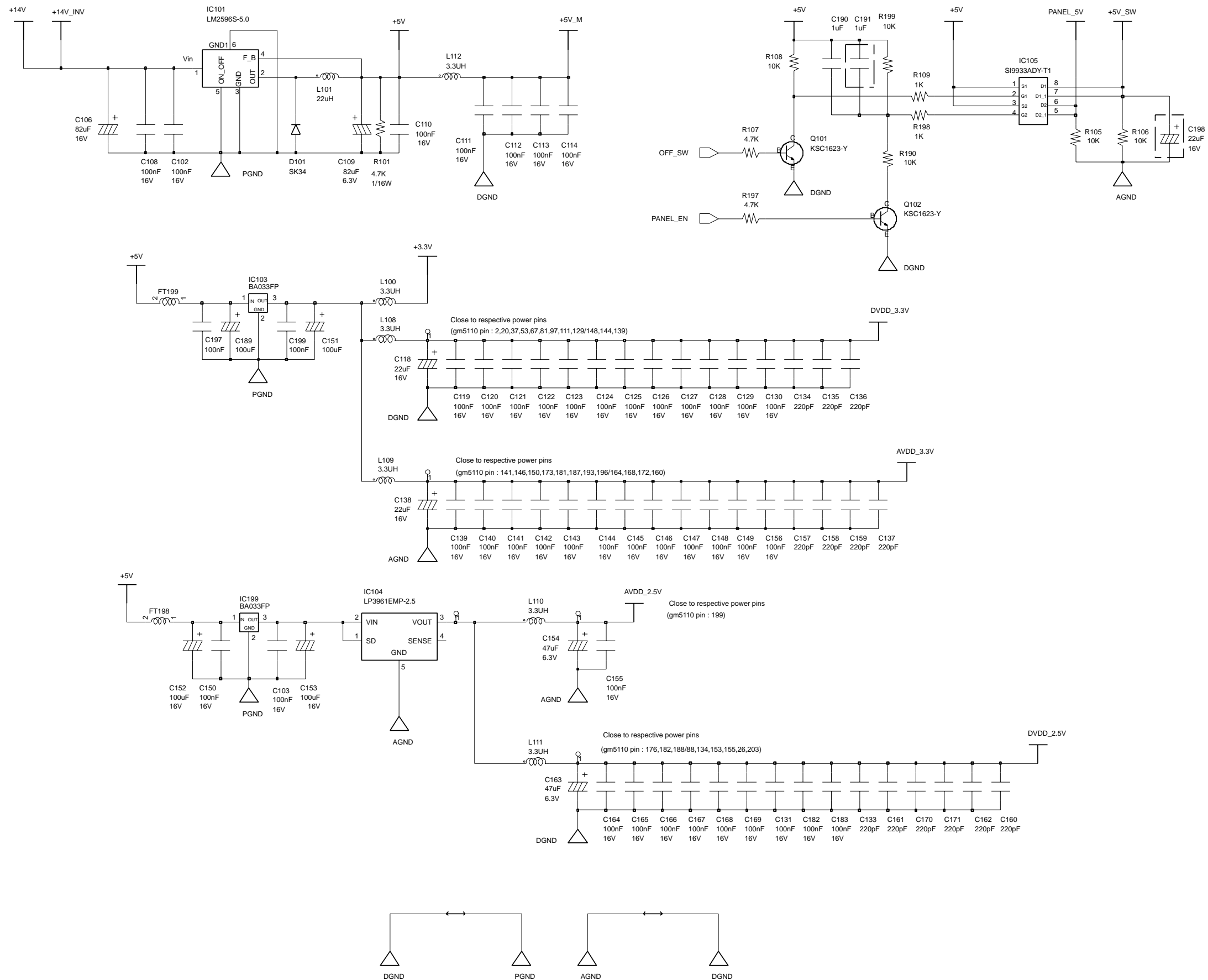

Memo

Memo

CONFIDENTIAL

7-2 M017E*

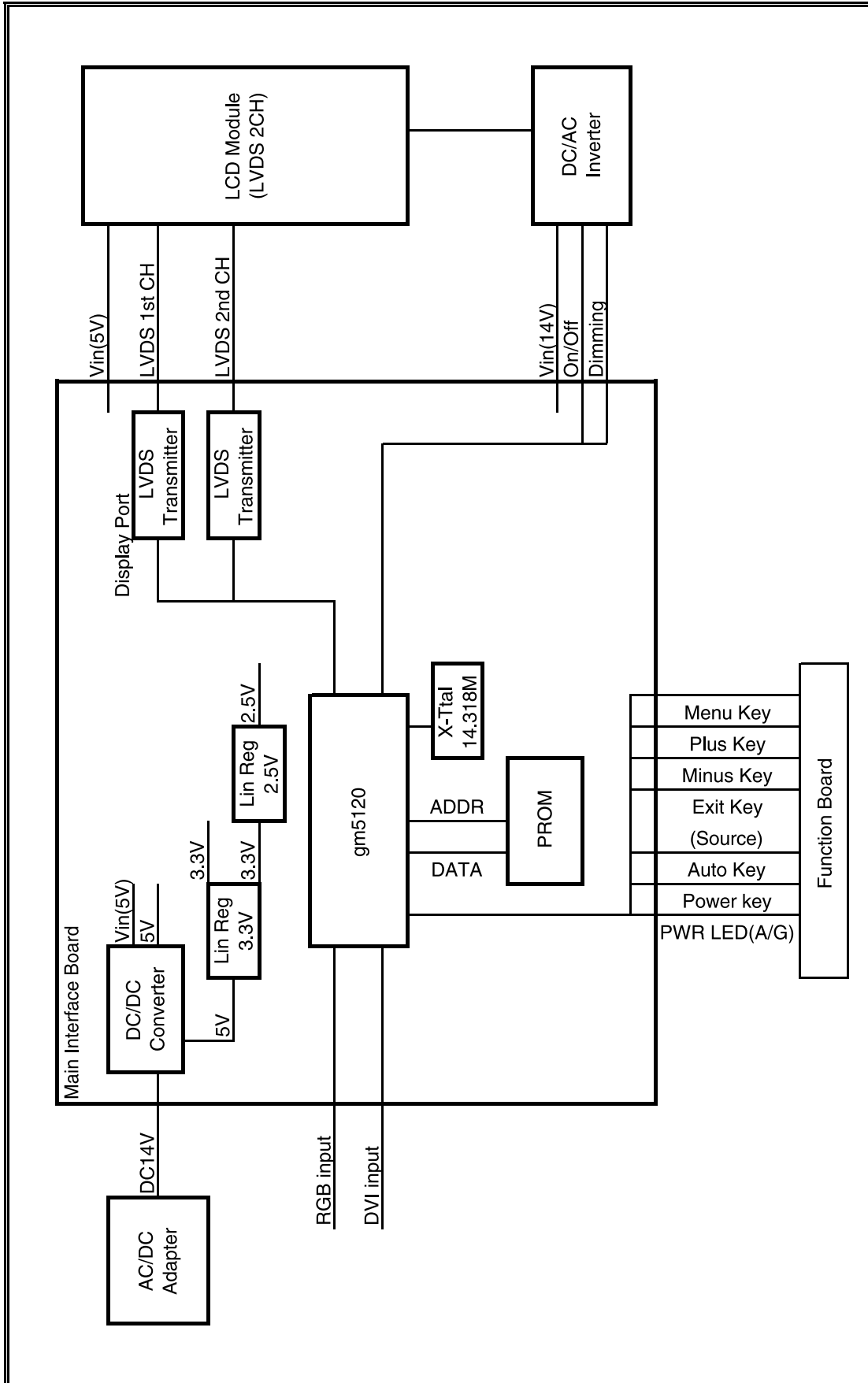

Loc. No.	Code No.	Description	Specification	Remarks
C145	2203-005005	C-CERAMIC,CHIP	100nF,10%,16V,X7R,TP,1608	
C146	2203-005005	C-CERAMIC,CHIP	100nF,10%,16V,X7R,TP,1608	
C147	2203-005005	C-CERAMIC,CHIP	100nF,10%,16V,X7R,TP,1608	
C148	2203-005005	C-CERAMIC,CHIP	100nF,10%,16V,X7R,TP,1608	
C149	2203-005005	C-CERAMIC,CHIP	100nF,10%,16V,X7R,TP,1608	
C150	2203-005005	C-CERAMIC,CHIP	100nF,10%,16V,X7R,TP,1608	
C151	2402-001042	C-AL,SMD	100uF,20%,16V,GP,TP,6.6x6.6x5.4mm	
C152	2402-001042	C-AL,SMD	100uF,20%,16V,GP,TP,6.6x6.6x5.4mm	
C153	2402-001042	C-AL,SMD	100uF,20%,16V,GP,TP,6.6x6.6x5.4mm	
C154	2409-001049	C-ORGANIC	47UF,20%,6.3V,FX,TP,5X5.9MM,-	
C155	2203-005005	C-CERAMIC,CHIP	100nF,10%,16V,X7R,TP,1608	
C156	2203-005005	C-CERAMIC,CHIP	100nF,10%,16V,X7R,TP,1608	
C157	2203-001607	C-CERAMIC,CHIP	0.22nF,5%,50V,NPO,TP,1608	
C158	2203-001607	C-CERAMIC,CHIP	0.22nF,5%,50V,NPO,TP,1608	
C159	2203-001607	C-CERAMIC,CHIP	0.22nF,5%,50V,NPO,TP,1608	
C160	2203-001607	C-CERAMIC,CHIP	0.22nF,5%,50V,NPO,TP,1608	
C161	2203-001607	C-CERAMIC,CHIP	0.22nF,5%,50V,NPO,TP,1608	
C162	2203-001607	C-CERAMIC,CHIP	0.22nF,5%,50V,NPO,TP,1608	
C163	2409-001049	C-ORGANIC	47UF,20%,6.3V,FX,TP,5X5.9MM,-	
C164	2203-005005	C-CERAMIC,CHIP	100nF,10%,16V,X7R,TP,1608	
C165	2203-005005	C-CERAMIC,CHIP	100nF,10%,16V,X7R,TP,1608	
C166	2203-005005	C-CERAMIC,CHIP	100nF,10%,16V,X7R,TP,1608	
C167	2203-005005	C-CERAMIC,CHIP	100nF,10%,16V,X7R,TP,1608	
C168	2203-005005	C-CERAMIC,CHIP	100nF,10%,16V,X7R,TP,1608	
C169	2203-005005	C-CERAMIC,CHIP	100nF,10%,16V,X7R,TP,1608	
C170	2203-001607	C-CERAMIC,CHIP	0.22nF,5%,50V,NPO,TP,1608	
C171	2203-001607	C-CERAMIC,CHIP	0.22nF,5%,50V,NPO,TP,1608	
C180	2402-001042	C-AL,SMD	100uF,20%,16V,GP,TP,6.6x6.6x5.4mm	
C181	2203-005005	C-CERAMIC,CHIP	100nF,10%,16V,X7R,TP,1608	
C182	2203-005005	C-CERAMIC,CHIP	100nF,10%,16V,X7R,TP,1608	
C183	2203-005005	C-CERAMIC,CHIP	100nF,10%,16V,X7R,TP,1608	
C189	2402-001042	C-AL,SMD	100uF,20%,16V,GP,TP,6.6x6.6x5.4mm	
C190	2203-005065	C-CERAMIC,CHIP	1000nF,+80-20%,10V,Y5V,TP,1608	
C197	2203-005005	C-CERAMIC,CHIP	100nF,10%,16V,X7R,TP,1608	
C199	2203-005005	C-CERAMIC,CHIP	100nF,10%,16V,X7R,TP,1608	
C201	2203-000257	C-CERAMIC,CHIP	10nF,10%,50V,X7R,TP,1608	
C202	2203-000257	C-CERAMIC,CHIP	10nF,10%,50V,X7R,TP,1608	
C203	2203-000257	C-CERAMIC,CHIP	10nF,10%,50V,X7R,TP,1608	
C204	2203-000257	C-CERAMIC,CHIP	10nF,10%,50V,X7R,TP,1608	
C205	2203-000257	C-CERAMIC,CHIP	10nF,10%,50V,X7R,TP,1608	
C206	2203-000257	C-CERAMIC,CHIP	10nF,10%,50V,X7R,TP,1608	
C207	2203-005005	C-CERAMIC,CHIP	100nF,10%,16V,X7R,TP,1608	
C210	2203-000384	C-CERAMIC,CHIP	0.015nF,5%,50V,NPO,TP,1608	
C211	2203-000626	C-CERAMIC,CHIP	0.022nF,5%,50V,NPO,TP,1608	
C212	2203-005005	C-CERAMIC,CHIP	100nF,10%,16V,X7R,TP,1608	
C213	2203-005005	C-CERAMIC,CHIP	100nF,10%,16V,X7R,TP,1608	
C218	2402-000108	C-AL,SMD	10uF,20%,16V,WT,TP,4.3x4.3x5.4	
C219	2203-005005	C-CERAMIC,CHIP	100nF,10%,16V,X7R,TP,1608	
C300	2203-005005	C-CERAMIC,CHIP	100nF,10%,16V,X7R,TP,1608	
C301	2203-005005	C-CERAMIC,CHIP	100nF,10%,16V,X7R,TP,1608	
C302	2203-001086	C-CERAMIC,CHIP	0.005nF,0.25pF,50V,NPO,TP,1608	
C303	2203-001086	C-CERAMIC,CHIP	0.005nF,0.25pF,50V,NPO,TP,1608	
C304	2203-005005	C-CERAMIC,CHIP	100nF,10%,16V,X7R,TP,1608	
C350	2402-000108	C-AL,SMD	10uF,20%,16V,WT,TP,4.3x4.3x5.4	

Loc. No.	Code No.	Description	Specification	Remarks
C351	2203-005005	C-CERAMIC,CHIP	100nF,10%,16V,X7R,TP,1608	
C352	2203-000257	C-CERAMIC,CHIP	10nF,10%,50V,X7R,TP,1608	
C353	2402-000108	C-AL,SMD	10uF,20%,16V,WT,TP,4.3x4.3x5.4	
C357	2203-000626	C-CERAMIC,CHIP	0.022nF,5%,50V,NP0,TP,1608	
C358	2203-000626	C-CERAMIC,CHIP	0.022nF,5%,50V,NP0,TP,1608	
C359	2203-000384	C-CERAMIC,CHIP	0.015nF,5%,50V,NP0,TP,1608	
C410	2203-005005	C-CERAMIC,CHIP	100nF,10%,16V,X7R,TP,1608	
C411	2203-005005	C-CERAMIC,CHIP	100nF,10%,16V,X7R,TP,1608	
C412	2203-005005	C-CERAMIC,CHIP	100nF,10%,16V,X7R,TP,1608	
C413	2402-001042	C-AL,SMD	100uF,20%,16V,GP,TP,6.6x6.6x5.4mm	
C414	2402-000108	C-AL,SMD	10uF,20%,16V,WT,TP,4.3x4.3x5.4	
C415	2203-005005	C-CERAMIC,CHIP	100nF,10%,16V,X7R,TP,1608	
C416	2203-005005	C-CERAMIC,CHIP	100nF,10%,16V,X7R,TP,1608	
C417	2203-005005	C-CERAMIC,CHIP	100nF,10%,16V,X7R,TP,1608	
C601	2203-005005	C-CERAMIC,CHIP	100nF,10%,16V,X7R,TP,1608	
C602	2203-005005	C-CERAMIC,CHIP	100nF,10%,16V,X7R,TP,1608	
C603	2203-005005	C-CERAMIC,CHIP	100nF,10%,16V,X7R,TP,1608	
C604	2203-005005	C-CERAMIC,CHIP	100nF,10%,16V,X7R,TP,1608	
C605	2203-005005	C-CERAMIC,CHIP	100nF,10%,16V,X7R,TP,1608	
C606	2203-005005	C-CERAMIC,CHIP	100nF,10%,16V,X7R,TP,1608	
C623	2203-005005	C-CERAMIC,CHIP	100nF,10%,16V,X7R,TP,1608	
C624	2203-005005	C-CERAMIC,CHIP	100nF,10%,16V,X7R,TP,1608	
C633	2203-005005	C-CERAMIC,CHIP	100nF,10%,16V,X7R,TP,1608	
C634	2203-005005	C-CERAMIC,CHIP	100nF,10%,16V,X7R,TP,1608	
C635	2203-005005	C-CERAMIC,CHIP	100nF,10%,16V,X7R,TP,1608	
C636	2203-005005	C-CERAMIC,CHIP	100nF,10%,16V,X7R,TP,1608	
C637	2203-005005	C-CERAMIC,CHIP	100nF,10%,16V,X7R,TP,1608	
CN102	3711-000556	CONNECTOR-HEADER	BOX,12P,1R,1.25mm,SMD-A,SN	SNA
CN202	3711-005076	CONNECTOR-HEADER	BOX,41P,2R,0.625MM,SMD-A,AUF,BLK	
CN402	3711-004070	CONNECTOR-HEADER	BOX,30P,1R,1.25mm,SMD-A,SN	SNA
CN601	3711-002050	CONNECTOR-HEADER	BOX,10P,1R,1.25mm,SMD-A,SN	SNA
D101	0402-001098	DIODE-RECTIFIER	SK34,40V,3A,SMC,TP	
D201	0401-001116	DIODE-SWITCHING	BAV99DW,75V,150MA,SOT-363,TP	
D203	0401-001056	DIODE-SWITCHING	MMBD4148SE,75V,200MA,SOT-23,TP	
D204	0401-001056	DIODE-SWITCHING	MMBD4148SE,75V,200MA,SOT-23,TP	
D205	0401-001056	DIODE-SWITCHING	MMBD4148SE,75V,200MA,SOT-23,TP	
D206	0401-001056	DIODE-SWITCHING	MMBD4148SE,75V,200MA,SOT-23,TP	
D207	0401-001056	DIODE-SWITCHING	MMBD4148SE,75V,200MA,SOT-23,TP	
D212	0403-000579	DIODE-ZENER	BZX84C5V1,5.1V,5%,200mW,SOT-23	
D213	0403-000579	DIODE-ZENER	BZX84C5V1,5.1V,5%,200mW,SOT-23	
D214	0403-001435	DIODE-ZENER	QZX363C5V6,5.32-5.88,200MW,SOT-363,TP	
D215	0403-000579	DIODE-ZENER	BZX84C5V1,5.1V,5%,200mW,SOT-23	
D216	0403-000579	DIODE-ZENER	BZX84C5V1,5.1V,5%,200mW,SOT-23	
D217	0403-000579	DIODE-ZENER	BZX84C5V1,5.1V,5%,200mW,SOT-23	
D218	0403-000579	DIODE-ZENER	BZX84C5V1,5.1V,5%,200mW,SOT-23	
D219	0403-001435	DIODE-ZENER	QZX363C5V6,5.32-5.88,200MW,SOT-363,TP	
D220	0401-001056	DIODE-SWITCHING	MMBD4148SE,75V,200MA,SOT-23,TP	
D221	0401-001056	DIODE-SWITCHING	MMBD4148SE,75V,200MA,SOT-23,TP	
D222	0401-001056	DIODE-SWITCHING	MMBD4148SE,75V,200MA,SOT-23,TP	
D223	0401-001056	DIODE-SWITCHING	MMBD4148SE,75V,200MA,SOT-23,TP	
D602	0403-001435	DIODE-ZENER	QZX363C5V6,5.32-5.88,200MW,SOT-363,TP	
D603	0403-001435	DIODE-ZENER	QZX363C5V6,5.32-5.88,200MW,SOT-363,TP	
FT101	3301-001145	CORE-FERRITE BEAD	AB,4.5x1.6x1.6mm,-,-	SNA
FT102	3301-001145	CORE-FERRITE BEAD	AB,4.5x1.6x1.6mm,-,-	SNA

Loc. No.	Code No.	Description	Specification	Remarks
FT198	3301-001145	CORE-FERRITE BEAD	AB,4.5x1.6x1.6mm,-,-	SNA
FT199	3301-001145	CORE-FERRITE BEAD	AB,4.5x1.6x1.6mm,-,-	SNA
FT402	3301-001145	CORE-FERRITE BEAD	AB,4.5x1.6x1.6mm,-,-	SNA
FT403	3301-001145	CORE-FERRITE BEAD	AB,4.5x1.6x1.6mm,-,-	SNA
FT404	3301-001145	CORE-FERRITE BEAD	AB,4.5x1.6x1.6mm,-,-	SNA
FT405	3301-001145	CORE-FERRITE BEAD	AB,4.5x1.6x1.6mm,-,-	SNA
IC101	1203-001448	IC-SWITCH VOL. REG.	2596,TO-263,5P,-,PLASTIC,4.750	
IC103	1203-001293	IC-POSI.FIXED REG.	033,TO-252,3P,6.5MIL,PLASTIC,3	
IC104	1203-001890	IC-VOLTAGE REGULATOR	3961,SOT223-5,5P,-,PLASTIC,2.5V,-,-40to+125C,800mA,-,TR	
IC105	0505-001170	FET-SILICON	SI9933ADY-T1,P,-,20V,3.4A,0.06ohm,2W,SO-8	
IC199	1203-001293	IC-POSI.FIXED REG.	033,TO-252,3P,6.5MIL,PLASTIC,3	
IC201	1103-000129	IC-EEPROM	24C02,256x8BIT,SOP,8P,150MIL,1	
IC202	1103-000129	IC-EEPROM	24C02,256x8BIT,SOP,8P,150MIL,1	
IC203	0803-000117	IC-TTL	74F14,INVERTER,SOP,14P,150MIL,	
IC301	1003-001497	IC-LCD CONTROLLER	GM5120,PQFP,208P,28X28MM,-,-,TR,PLASTIC,3.6V,0TO+70C,1.5W,-,-	
IC302	1102-001097	IC-EPROM	27C010,128KX8BIT,PLCC,32P,-,90NS,5V,10%,PLASTIC,0TO+70C,0.1MA,CMOS,TR	
IC302_SOCKET	3704-000249	SOCKET-IC	32P,PLCC,SN,1.27mm	
IC303	1203-001212	IC-VOL. DETECTOR	7029,SOT-89,3P,-,PLASTIC,-,500	
IC305	1103-001023	IC-EEPROM	524C08D81,1028x8BIT,SOP,8P,150MIL,10mS,5V,10%,PLASTIC,0to+70C,110uA,CMOS,TP	
IC401	1205-002174	IC-TRANSMITTER	NT7181,TSSOP,56P,236MIL,PLASTIC,3.45V,-,0TO+70C,TP,NT7181	
IC402	1205-002174	IC-TRANSMITTER	NT7181,TSSOP,56P,236MIL,PLASTIC,3.45V,-,0TO+70C,TP,NT7181	
JP10	2007-000090	R-CHIP	10KOHM,5%,1/16W,DA,TP,1608	
JP15	2007-000090	R-CHIP	10KOHM,5%,1/16W,DA,TP,1608	
JP9	2007-000090	R-CHIP	10KOHM,5%,1/16W,DA,TP,1608	
L100	2703-001778	INDUCTOR-SMD	3.3UH,20%,3.2X2.5X2.2MM	
L101	BN27-00008A	COIL CHOKE-SMD	SMD12*12*8.5,GH15/17PS,22UH,±20%,0.045OHM MAX,3.0A,DR10X7/SMD12X6.7,16.5TS	
L108	2703-001778	INDUCTOR-SMD	3.3UH,20%,3.2X2.5X2.2MM	
L109	2703-001778	INDUCTOR-SMD	3.3UH,20%,3.2X2.5X2.2MM	
L110	2703-001778	INDUCTOR-SMD	3.3UH,20%,3.2X2.5X2.2MM	
L111	2703-001778	INDUCTOR-SMD	3.3UH,20%,3.2X2.5X2.2MM	
L112	2703-001778	INDUCTOR-SMD	3.3UH,20%,3.2X2.5X2.2MM	
MP1.0	BN41-00188A	PCB MAIN	MO17PS,FR4,4L,120X110X1.0,MO17PS	
Q101	0501-000342	TR-SMALL SIGNAL	KSC1623-Y,NPN,200mW,SOT-23,TP,135-270	
Q102	0501-000342	TR-SMALL SIGNAL	KSC1623-Y,NPN,200mW,SOT-23,TP,135-270	
Q201	0501-000342	TR-SMALL SIGNAL	KSC1623-Y,NPN,200mW,SOT-23,TP,135-270	
R101	2007-000084	R-CHIP	4.7Kohm,5%,1/16W,DA,TP,1608	
R105	2007-000090	R-CHIP	10KOHM,5%,1/16W,DA,TP,1608	
R106	2007-000090	R-CHIP	10KOHM,5%,1/16W,DA,TP,1608	
R107	2007-000084	R-CHIP	4.7Kohm,5%,1/16W,DA,TP,1608	
R108	2007-000090	R-CHIP	10KOHM,5%,1/16W,DA,TP,1608	
R109	2007-000078	R-CHIP	1Kohm,5%,1/16W,DA,TP,1608	
R190	2007-000090	R-CHIP	10KOHM,5%,1/16W,DA,TP,1608	
R197	2007-000084	R-CHIP	4.7Kohm,5%,1/16W,DA,TP,1608	
R198	2007-000078	R-CHIP	1Kohm,5%,1/16W,DA,TP,1608	
R199	2007-000090	R-CHIP	10KOHM,5%,1/16W,DA,TP,1608	
R201	2007-000074	R-CHIP	100ohm,5%,1/16W,DA,TP,1608	
R202	2007-000074	R-CHIP	100ohm,5%,1/16W,DA,TP,1608	
R203	2007-000074	R-CHIP	100ohm,5%,1/16W,DA,TP,1608	
R204	2007-000074	R-CHIP	100ohm,5%,1/16W,DA,TP,1608	
R205	2007-000074	R-CHIP	100ohm,5%,1/16W,DA,TP,1608	
R207	2007-001164	R-CHIP	75ohm,1%,1/16W,DA,TP,1608	
R208	2007-001164	R-CHIP	75ohm,1%,1/16W,DA,TP,1608	
R209	2007-001164	R-CHIP	75ohm,1%,1/16W,DA,TP,1608	
R210	2007-000071	R-CHIP	22ohm,5%,1/16W,DA,TP,1608	

Loc. No.	Code No.	Description	Specification	Remarks
R211	2007-000071	R-CHIP	22ohm,5%,1/16W,DA,TP,1608	
R212	2007-000071	R-CHIP	22ohm,5%,1/16W,DA,TP,1608	
R213	2007-000071	R-CHIP	22ohm,5%,1/16W,DA,TP,1608	
R214	2007-000071	R-CHIP	22ohm,5%,1/16W,DA,TP,1608	
R215	2007-000071	R-CHIP	22ohm,5%,1/16W,DA,TP,1608	
R216	2007-000071	R-CHIP	22ohm,5%,1/16W,DA,TP,1608	
R217	2007-000071	R-CHIP	22ohm,5%,1/16W,DA,TP,1608	
R218	2007-000092	R-CHIP	15Kohm,5%,1/16W,DA,TP,1608	
R219	2007-000092	R-CHIP	15Kohm,5%,1/16W,DA,TP,1608	
R220	2007-000074	R-CHIP	100ohm,5%,1/16W,DA,TP,1608	
R221	2007-000074	R-CHIP	100ohm,5%,1/16W,DA,TP,1608	
R222	2007-000090	R-CHIP	10KOHM,5%,1/16W,DA,TP,1608	
R223	2007-000080	R-CHIP	2Kohm,5%,1/16W,DA,TP,1608	
R224	2007-000074	R-CHIP	100ohm,5%,1/16W,DA,TP,1608	
R225	2007-000071	R-CHIP	22ohm,5%,1/16W,DA,TP,1608	
R226	2007-000090	R-CHIP	10KOHM,5%,1/16W,DA,TP,1608	
R227	2007-000080	R-CHIP	2Kohm,5%,1/16W,DA,TP,1608	
R228	2007-001002	R-CHIP	510ohm,5%,1/16W,DA,TP,1608	
R229	2007-000097	R-CHIP	47Kohm,5%,1/16W,DA,TP,1608	
R230	2007-000097	R-CHIP	47Kohm,5%,1/16W,DA,TP,1608	
R231	2007-000074	R-CHIP	100ohm,5%,1/16W,DA,TP,1608	
R232	2007-000074	R-CHIP	100ohm,5%,1/16W,DA,TP,1608	
R236	2007-000078	R-CHIP	1Kohm,5%,1/16W,DA,TP,1608	
R237	2007-000090	R-CHIP	10KOHM,5%,1/16W,DA,TP,1608	
R252	2007-000084	R-CHIP	4.7Kohm,5%,1/16W,DA,TP,1608	
R270	2007-000070	R-CHIP	0ohm,5%,1/16W,DA,TP,1608	
R302	2007-000121	R-CHIP	820ohm,5%,1/16W,DA,TP,1608	
R321	2007-000090	R-CHIP	10KOHM,5%,1/16W,DA,TP,1608	
R322	2007-000090	R-CHIP	10KOHM,5%,1/16W,DA,TP,1608	
R324	2007-000090	R-CHIP	10KOHM,5%,1/16W,DA,TP,1608	
R329	2007-000090	R-CHIP	10KOHM,5%,1/16W,DA,TP,1608	
R330	2007-000090	R-CHIP	10KOHM,5%,1/16W,DA,TP,1608	
R331	2007-000074	R-CHIP	100ohm,5%,1/16W,DA,TP,1608	
R334	2007-000074	R-CHIP	100ohm,5%,1/16W,DA,TP,1608	
R350	2007-000092	R-CHIP	15Kohm,5%,1/16W,DA,TP,1608	
R353	2007-000074	R-CHIP	100ohm,5%,1/16W,DA,TP,1608	
R354	2007-000074	R-CHIP	100ohm,5%,1/16W,DA,TP,1608	
R357	2007-000077	R-CHIP	470ohm,5%,1/16W,DA,TP,1608	
R358	2007-000077	R-CHIP	470ohm,5%,1/16W,DA,TP,1608	
R359	2007-000077	R-CHIP	470ohm,5%,1/16W,DA,TP,1608	
R360	2007-000074	R-CHIP	100ohm,5%,1/16W,DA,TP,1608	
R361	2007-001167	R-CHIP	75ohm,5%,1/16W,DA,TP,1608	
R362	2007-001167	R-CHIP	75ohm,5%,1/16W,DA,TP,1608	
R363	2007-001167	R-CHIP	75ohm,5%,1/16W,DA,TP,1608	
R364	2007-000074	R-CHIP	100ohm,5%,1/16W,DA,TP,1608	
R365	2007-000090	R-CHIP	10KOHM,5%,1/16W,DA,TP,1608	
R366	2007-000074	R-CHIP	100ohm,5%,1/16W,DA,TP,1608	
R391	2007-000074	R-CHIP	100ohm,5%,1/16W,DA,TP,1608	
R392	2007-000090	R-CHIP	10KOHM,5%,1/16W,DA,TP,1608	
R395	2007-000074	R-CHIP	100ohm,5%,1/16W,DA,TP,1608	
R396	2007-000090	R-CHIP	10KOHM,5%,1/16W,DA,TP,1608	
R410	2007-000070	R-CHIP	0ohm,5%,1/16W,DA,TP,1608	
R411	2007-000072	R-CHIP	47ohm,5%,1/16W,DA,TP,1608	
R412	2007-000072	R-CHIP	47ohm,5%,1/16W,DA,TP,1608	

Loc. No.	Code No.	Description	Specification	Remarks
R413	2007-000072	R-CHIP	47ohm,5%,1/16W,DA,TP,1608	
R414	2007-000072	R-CHIP	47ohm,5%,1/16W,DA,TP,1608	
R415	2007-000072	R-CHIP	47ohm,5%,1/16W,DA,TP,1608	
R416	2007-000072	R-CHIP	47ohm,5%,1/16W,DA,TP,1608	
R417	2007-000072	R-CHIP	47ohm,5%,1/16W,DA,TP,1608	
R418	2007-000072	R-CHIP	47ohm,5%,1/16W,DA,TP,1608	
R419	2007-000072	R-CHIP	47ohm,5%,1/16W,DA,TP,1608	
R420	2007-000072	R-CHIP	47ohm,5%,1/16W,DA,TP,1608	
R421	2007-000070	R-CHIP	0ohm,5%,1/16W,DA,TP,1608	
R601	2007-000090	R-CHIP	10KOHM,5%,1/16W,DA,TP,1608	
R602	2007-000090	R-CHIP	10KOHM,5%,1/16W,DA,TP,1608	
R603	2007-000090	R-CHIP	10KOHM,5%,1/16W,DA,TP,1608	
R604	2007-000090	R-CHIP	10KOHM,5%,1/16W,DA,TP,1608	
R605	2007-000090	R-CHIP	10KOHM,5%,1/16W,DA,TP,1608	
R606	2007-000090	R-CHIP	10KOHM,5%,1/16W,DA,TP,1608	
R607	2007-000074	R-CHIP	100ohm,5%,1/16W,DA,TP,1608	
R608	2007-000074	R-CHIP	100ohm,5%,1/16W,DA,TP,1608	
R609	2007-000074	R-CHIP	100ohm,5%,1/16W,DA,TP,1608	
R610	2007-000074	R-CHIP	100ohm,5%,1/16W,DA,TP,1608	
R612	2007-000074	R-CHIP	100ohm,5%,1/16W,DA,TP,1608	
R617	2007-000074	R-CHIP	100ohm,5%,1/16W,DA,TP,1608	
R626	2007-000074	R-CHIP	100ohm,5%,1/16W,DA,TP,1608	
R627	2007-000074	R-CHIP	100ohm,5%,1/16W,DA,TP,1608	
R690	2007-000072	R-CHIP	47ohm,5%,1/16W,DA,TP,1608	
R691	2007-000072	R-CHIP	47ohm,5%,1/16W,DA,TP,1608	
R692	2007-000072	R-CHIP	47ohm,5%,1/16W,DA,TP,1608	
R693	2007-000072	R-CHIP	47ohm,5%,1/16W,DA,TP,1608	
R694	2007-000072	R-CHIP	47ohm,5%,1/16W,DA,TP,1608	
R695	2007-000072	R-CHIP	47ohm,5%,1/16W,DA,TP,1608	
R696	2007-000072	R-CHIP	47ohm,5%,1/16W,DA,TP,1608	
R697	2007-000072	R-CHIP	47ohm,5%,1/16W,DA,TP,1608	
R698	2007-000072	R-CHIP	47ohm,5%,1/16W,DA,TP,1608	
R699	2007-000072	R-CHIP	47ohm,5%,1/16W,DA,TP,1608	
R709	2007-000070	R-CHIP	0ohm,5%,1/16W,DA,TP,1608	
R710	2007-000074	R-CHIP	100ohm,5%,1/16W,DA,TP,1608	
RA301	2011-001193	R-NETWORK	68ohm,5%,1/16W,L,CHIP,8P,TP	
RA302	2011-001193	R-NETWORK	68ohm,5%,1/16W,L,CHIP,8P,TP	
RA303	2011-001410	R-NETWORK	120OHM,5%,1/16W,L,CHIP,8P,TP	
RA304	2011-001410	R-NETWORK	120OHM,5%,1/16W,L,CHIP,8P,TP	
RA305	2011-001410	R-NETWORK	120OHM,5%,1/16W,L,CHIP,8P,TP	
RA306	2011-001410	R-NETWORK	120OHM,5%,1/16W,L,CHIP,8P,TP	
RA307	2011-001410	R-NETWORK	120OHM,5%,1/16W,L,CHIP,8P,TP	
RA308	2011-001410	R-NETWORK	120OHM,5%,1/16W,L,CHIP,8P,TP	
RA309	2011-001410	R-NETWORK	120OHM,5%,1/16W,L,CHIP,8P,TP	
RA310	2011-001410	R-NETWORK	120OHM,5%,1/16W,L,CHIP,8P,TP	
RA311	2011-001410	R-NETWORK	120OHM,5%,1/16W,L,CHIP,8P,TP	
RA312	2011-001410	R-NETWORK	120OHM,5%,1/16W,L,CHIP,8P,TP	
RA313	2011-001410	R-NETWORK	120OHM,5%,1/16W,L,CHIP,8P,TP	
RA314	2011-001410	R-NETWORK	120OHM,5%,1/16W,L,CHIP,8P,TP	
X301	2801-003667	CRYSTAL-SMD	14.3182MHZ,50PPM,28-AAN,16,500HM,TP	

Loc. No.	Code No.	Description	Specification	Remarks
-	BN92-00547A	ASSY BOX	M017PS	SNA
CIS	BH68-00329C	LABEL BAR CODE	-,ALL,TC099,DOMESTIC,ART-PAPER 90G,-,WHT,BLACK,-,-,-	SNA
CIS	BH75-10529C	UNIT-HANDLE/PACKING	S/M170MP,PE-LD,PE-HD,-,WHITE,-	SNA
CIS	BN72-60001A	LEVER TOP	LSD210TL,PE-LD,WHITE,TFT_LCD	SNA
CIS	BN72-60002C	LEVER BOTTOM	S/M170MP,PE-HD,BLUE	SNA
CIS	BN69-00372A	BOX	S/M172T,W/W,CB-SW4,WHT,OFFSET,A-1,L473*W399*H122	SNA
-	BN92-00548A	ASSY LABEL	M017PS	SNA
CIS	BN68-00309B	LABEL RATING	M017PS,EDC,SYNC,PE,T0.05,90,45,PE NATURE,SILVER/GUNMETAL	SNA
-	BN92-00549A	ASSY ACCESSORY	M017PS	SNA
-	BN92-00550A	ASSY P/MATERIAL	M017PS	SNA
P/M	0203-001100	TAPE-OPP MASKING	OPP/W75/CLR,T0.05,W75,L800000,CLR	SNA
P/M	BH69-00328B	PAD-EDGE	ML17,DW3,200,1370,-,-,YEL,-,-	SNA
P/M	BH69-00457C	PACKING-PAD	CY15PO,FOAM,T3.0,1320,880	SNA
P/M	BH69-30355C	BAG-FPD	HDPE+PE FOAM,0.02+0.5,-,Y(24)-,IBM	SNA
P/M	BH69-40379A	PACKING-WRAP	LDPE,W500*T0.02,-,-	SNA
P/M	BN69-00131P	PALLET-PACKING	M017,WOODEN,1462,830,120	SNA
P/M	BN69-00140M	PAD-PALLET COVER	IBM15,SW,800*3540,1295,-,-,-,-	SNA
P/M	BN69-00140V	PAD-PALLET COVER	RB15AS,SW4,1200,3530,-,-,-,-	SNA
P/M	BN69-00300A	CUSHION-EPE	M015PS/ES,SHEET EPS,T5.0	SNA
P/M	BN69-00327A	CUSHION-R/L	M017PS,EPS,M50	SNA
P/M	BN96-00115A	ASSY MISC P-BRKT-VESA	M015PS,SECC T1.6	SNA
-	EM-M017PS	2	SEC,E6-L02	-

6-2-1 MO17E* Main PCB Parts

Loc. No.	Code No.	Description	Specification	Remarks
-	BN94-00357A	ASSY PCB MAIN	MO17ES	SNA
CIS1	0201-001223	ADHESIVE-TS	HT-130S,RED,700+/- 50,-	SNA
CIS2	0202-001044	SOLDER-WIRE.	S63S-W3.0,S63S,D3,63Sn/37Pb,-	SNA
CIS4	0202-001046	SOLDER-WIRE FLUX	CF-110VH-2A,-,-,-,-	SNA
CIS5	0202-001162	SOLDER-CREAM	RMA-20-21L,S63,-,SN63/PB36.6/AGO.4,FLUX9.5%	SNA
CIS6	0202-001222	SOLDER-WIRE FLUX	RS-107,RS60-1.2AA,D1.2,SN60/PB40,-	SNA
CIS7	0204-001095	THINNER	#4520,-,-,-	SNA
CIS3	BN39-00002A	CBF-HARNESS	-.60,BLU/WHT,-,-,26,-	SNA
CIS11	BN63-00433A	GASKET	MO17PS,CONDUCTIVE FABRIC,2MM,10MM,10MM,GRAY,71TSSK 10-2-10-13,71TSSK 10-2-10-13	
CIS10	BN63-00435A	GASKET	MO17PS,CONDUCTIVE FABRIC,2MM,4MM,40MM,GRAY,71TSSK 4-2-40-13,71TSSK 4-2-40-13	
-	BN97-00115S	ASSY MICOM	MO17ES	
IC302	1102-001097	IC-EPROM	27C010,128KX8BIT,PLCC,32P,-,90NS,5V,10%,PLASTIC,OTO+70C,0.1MA,CMOS,TR	
CIS	BN46-00014N	S/W MICOM-S/W	MO17ES	SNA
-	BN97-00146A	ASSY SMD	MO17ES	SNA
C102	2203-005005	C-CERAMIC,CHIP	100nF,10%,16V,X7R,TP,1608	
C103	2203-005005	C-CERAMIC,CHIP	100nF,10%,16V,X7R,TP,1608	
C106	2409-001065	C-ORGANIC	82UF,20%,16V,WT,TP,8X6.9MM,-	
C108	2203-005005	C-CERAMIC,CHIP	100nF,10%,16V,X7R,TP,1608	
C109	2409-001051	C-ORGANIC	82UF,20%,6.3V,WT,TP,6.3*5.9MM,2.1	
C110	2203-005005	C-CERAMIC,CHIP	100nF,10%,16V,X7R,TP,1608	
C111	2203-005005	C-CERAMIC,CHIP	100nF,10%,16V,X7R,TP,1608	
C112	2203-005005	C-CERAMIC,CHIP	100nF,10%,16V,X7R,TP,1608	
C113	2203-005005	C-CERAMIC,CHIP	100nF,10%,16V,X7R,TP,1608	
C114	2203-005005	C-CERAMIC,CHIP	100nF,10%,16V,X7R,TP,1608	
C118	2402-000135	C-AL,SMD	22uF,20%,16V,GP,TP,5.3x5.3x5.4	
C119	2203-005005	C-CERAMIC,CHIP	100nF,10%,16V,X7R,TP,1608	
C120	2203-005005	C-CERAMIC,CHIP	100nF,10%,16V,X7R,TP,1608	
C121	2203-005005	C-CERAMIC,CHIP	100nF,10%,16V,X7R,TP,1608	
C122	2203-005005	C-CERAMIC,CHIP	100nF,10%,16V,X7R,TP,1608	
C123	2203-005005	C-CERAMIC,CHIP	100nF,10%,16V,X7R,TP,1608	
C124	2203-005005	C-CERAMIC,CHIP	100nF,10%,16V,X7R,TP,1608	
C125	2203-005005	C-CERAMIC,CHIP	100nF,10%,16V,X7R,TP,1608	
C126	2203-005005	C-CERAMIC,CHIP	100nF,10%,16V,X7R,TP,1608	
C127	2203-005005	C-CERAMIC,CHIP	100nF,10%,16V,X7R,TP,1608	
C128	2203-005005	C-CERAMIC,CHIP	100nF,10%,16V,X7R,TP,1608	
C129	2203-005005	C-CERAMIC,CHIP	100nF,10%,16V,X7R,TP,1608	
C130	2203-005005	C-CERAMIC,CHIP	100nF,10%,16V,X7R,TP,1608	
C131	2203-005005	C-CERAMIC,CHIP	100nF,10%,16V,X7R,TP,1608	
C133	2203-001607	C-CERAMIC,CHIP	0.22nF,5%,50V,NPO,TP,1608	
C134	2203-001607	C-CERAMIC,CHIP	0.22nF,5%,50V,NPO,TP,1608	
C135	2203-001607	C-CERAMIC,CHIP	0.22nF,5%,50V,NPO,TP,1608	
C136	2203-001607	C-CERAMIC,CHIP	0.22nF,5%,50V,NPO,TP,1608	
C137	2203-001607	C-CERAMIC,CHIP	0.22nF,5%,50V,NPO,TP,1608	
C138	2402-000135	C-AL,SMD	22uF,20%,16V,GP,TP,5.3x5.3x5.4	
C139	2203-005005	C-CERAMIC,CHIP	100nF,10%,16V,X7R,TP,1608	
C140	2203-005005	C-CERAMIC,CHIP	100nF,10%,16V,X7R,TP,1608	
C141	2203-005005	C-CERAMIC,CHIP	100nF,10%,16V,X7R,TP,1608	
C142	2203-005005	C-CERAMIC,CHIP	100nF,10%,16V,X7R,TP,1608	
C143	2203-005005	C-CERAMIC,CHIP	100nF,10%,16V,X7R,TP,1608	
C144	2203-005005	C-CERAMIC,CHIP	100nF,10%,16V,X7R,TP,1608	
C145	2203-005005	C-CERAMIC,CHIP	100nF,10%,16V,X7R,TP,1608	

Loc. No.	Code No.	Description	Specification	Remarks
C146	2203-005005	C-CERAMIC,CHIP	100nF,10%,16V,X7R,TP,1608	
C147	2203-005005	C-CERAMIC,CHIP	100nF,10%,16V,X7R,TP,1608	
C148	2203-005005	C-CERAMIC,CHIP	100nF,10%,16V,X7R,TP,1608	
C149	2203-005005	C-CERAMIC,CHIP	100nF,10%,16V,X7R,TP,1608	
C150	2203-005005	C-CERAMIC,CHIP	100nF,10%,16V,X7R,TP,1608	
C151	2402-001042	C-AL,SMD	100uF,20%,16V,GP,TP,6.6x6.6x5.4mm	
C152	2402-001042	C-AL,SMD	100uF,20%,16V,GP,TP,6.6x6.6x5.4mm	
C153	2402-001042	C-AL,SMD	100uF,20%,16V,GP,TP,6.6x6.6x5.4mm	
C154	2409-001049	C-ORGANIC	47UF,20%,6.3V,FX,TP,5X5.9MM,-	
C155	2203-005005	C-CERAMIC,CHIP	100nF,10%,16V,X7R,TP,1608	
C156	2203-005005	C-CERAMIC,CHIP	100nF,10%,16V,X7R,TP,1608	
C157	2203-001607	C-CERAMIC,CHIP	0.22nF,5%,50V,NPO,TP,1608	
C158	2203-001607	C-CERAMIC,CHIP	0.22nF,5%,50V,NPO,TP,1608	
C159	2203-001607	C-CERAMIC,CHIP	0.22nF,5%,50V,NPO,TP,1608	
C160	2203-001607	C-CERAMIC,CHIP	0.22nF,5%,50V,NPO,TP,1608	
C161	2203-001607	C-CERAMIC,CHIP	0.22nF,5%,50V,NPO,TP,1608	
C162	2203-001607	C-CERAMIC,CHIP	0.22nF,5%,50V,NPO,TP,1608	
C163	2409-001049	C-ORGANIC	47UF,20%,6.3V,FX,TP,5X5.9MM,-	
C164	2203-005005	C-CERAMIC,CHIP	100nF,10%,16V,X7R,TP,1608	
C165	2203-005005	C-CERAMIC,CHIP	100nF,10%,16V,X7R,TP,1608	
C166	2203-005005	C-CERAMIC,CHIP	100nF,10%,16V,X7R,TP,1608	
C167	2203-005005	C-CERAMIC,CHIP	100nF,10%,16V,X7R,TP,1608	
C168	2203-005005	C-CERAMIC,CHIP	100nF,10%,16V,X7R,TP,1608	
C169	2203-005005	C-CERAMIC,CHIP	100nF,10%,16V,X7R,TP,1608	
C170	2203-001607	C-CERAMIC,CHIP	0.22nF,5%,50V,NPO,TP,1608	
C171	2203-001607	C-CERAMIC,CHIP	0.22nF,5%,50V,NPO,TP,1608	
C180	2402-001042	C-AL,SMD	100uF,20%,16V,GP,TP,6.6x6.6x5.4mm	
C181	2203-005005	C-CERAMIC,CHIP	100nF,10%,16V,X7R,TP,1608	
C182	2203-005005	C-CERAMIC,CHIP	100nF,10%,16V,X7R,TP,1608	
C183	2203-005005	C-CERAMIC,CHIP	100nF,10%,16V,X7R,TP,1608	
C189	2402-001042	C-AL,SMD	100uF,20%,16V,GP,TP,6.6x6.6x5.4mm	
C190	2203-005065	C-CERAMIC,CHIP	1000nF,+80-20%,10V,Y5V,TP,1608	
C197	2203-005005	C-CERAMIC,CHIP	100nF,10%,16V,X7R,TP,1608	
C199	2203-005005	C-CERAMIC,CHIP	100nF,10%,16V,X7R,TP,1608	
C201	2203-000257	C-CERAMIC,CHIP	10nF,10%,50V,X7R,TP,1608	
C202	2203-000257	C-CERAMIC,CHIP	10nF,10%,50V,X7R,TP,1608	
C203	2203-000257	C-CERAMIC,CHIP	10nF,10%,50V,X7R,TP,1608	
C204	2203-000257	C-CERAMIC,CHIP	10nF,10%,50V,X7R,TP,1608	
C205	2203-000257	C-CERAMIC,CHIP	10nF,10%,50V,X7R,TP,1608	
C206	2203-000257	C-CERAMIC,CHIP	10nF,10%,50V,X7R,TP,1608	
C207	2203-005005	C-CERAMIC,CHIP	100nF,10%,16V,X7R,TP,1608	
C210	2203-000384	C-CERAMIC,CHIP	0.015nF,5%,50V,NPO,TP,1608	
C211	2203-000626	C-CERAMIC,CHIP	0.022nF,5%,50V,NPO,TP,1608	
C213	2203-005005	C-CERAMIC,CHIP	100nF,10%,16V,X7R,TP,1608	
C218	2402-000108	C-AL,SMD	10uF,20%,16V,WT,TP,4.3x4.3x5.4	
C219	2203-005005	C-CERAMIC,CHIP	100nF,10%,16V,X7R,TP,1608	
C300	2203-005005	C-CERAMIC,CHIP	100nF,10%,16V,X7R,TP,1608	
C301	2203-005005	C-CERAMIC,CHIP	100nF,10%,16V,X7R,TP,1608	
C302	2203-001086	C-CERAMIC,CHIP	0.005nF,0.25pF,50V,NPO,TP,1608	
C303	2203-001086	C-CERAMIC,CHIP	0.005nF,0.25pF,50V,NPO,TP,1608	
C304	2203-005005	C-CERAMIC,CHIP	100nF,10%,16V,X7R,TP,1608	
C350	2402-000108	C-AL,SMD	10uF,20%,16V,WT,TP,4.3x4.3x5.4	
C351	2203-005005	C-CERAMIC,CHIP	100nF,10%,16V,X7R,TP,1608	

Loc. No.	Code No.	Description	Specification	Remarks
C352	2203-000257	C-CERAMIC,CHIP	10nF,10%,50V,X7R,TP,1608	
C353	2402-000108	C-AL,SMD	10uF,20%,16V,WT,TP,4.3x4.3x5.4	
C357	2203-000626	C-CERAMIC,CHIP	0.022nF,5%,50V,NPO,TP,1608	
C358	2203-000626	C-CERAMIC,CHIP	0.022nF,5%,50V,NPO,TP,1608	
C359	2203-000384	C-CERAMIC,CHIP	0.015nF,5%,50V,NPO,TP,1608	
C410	2203-005005	C-CERAMIC,CHIP	100nF,10%,16V,X7R,TP,1608	
C411	2203-005005	C-CERAMIC,CHIP	100nF,10%,16V,X7R,TP,1608	
C412	2203-005005	C-CERAMIC,CHIP	100nF,10%,16V,X7R,TP,1608	
C413	2402-001042	C-AL,SMD	100uF,20%,16V,GP,TP,6.6x6.6x5.4mm	
C414	2402-000108	C-AL,SMD	10uF,20%,16V,WT,TP,4.3x4.3x5.4	
C415	2203-005005	C-CERAMIC,CHIP	100nF,10%,16V,X7R,TP,1608	
C416	2203-005005	C-CERAMIC,CHIP	100nF,10%,16V,X7R,TP,1608	
C417	2203-005005	C-CERAMIC,CHIP	100nF,10%,16V,X7R,TP,1608	
C601	2203-005005	C-CERAMIC,CHIP	100nF,10%,16V,X7R,TP,1608	
C602	2203-005005	C-CERAMIC,CHIP	100nF,10%,16V,X7R,TP,1608	
C603	2203-005005	C-CERAMIC,CHIP	100nF,10%,16V,X7R,TP,1608	
C604	2203-005005	C-CERAMIC,CHIP	100nF,10%,16V,X7R,TP,1608	
C605	2203-005005	C-CERAMIC,CHIP	100nF,10%,16V,X7R,TP,1608	
C606	2203-005005	C-CERAMIC,CHIP	100nF,10%,16V,X7R,TP,1608	
C623	2203-005005	C-CERAMIC,CHIP	100nF,10%,16V,X7R,TP,1608	
C624	2203-005005	C-CERAMIC,CHIP	100nF,10%,16V,X7R,TP,1608	
C633	2203-005005	C-CERAMIC,CHIP	100nF,10%,16V,X7R,TP,1608	
C634	2203-005005	C-CERAMIC,CHIP	100nF,10%,16V,X7R,TP,1608	
C635	2203-005005	C-CERAMIC,CHIP	100nF,10%,16V,X7R,TP,1608	
C636	2203-005005	C-CERAMIC,CHIP	100nF,10%,16V,X7R,TP,1608	
C637	2203-005005	C-CERAMIC,CHIP	100nF,10%,16V,X7R,TP,1608	
CN102	3711-000556	CONNECTOR-HEADER	BOX,12P,1R,1.25mm,SMD-A,SN	SNA
CN202	3711-003161	CONNECTOR-HEADER	BOX,20P,1R,1.25mm,ANGLE,SN	SNA
CN402	3711-004070	CONNECTOR-HEADER	BOX,30P,1R,1.25mm,SMD-A,SN	SNA
CN601	3711-002050	CONNECTOR-HEADER	BOX,10P,1R,1.25mm,SMD-A,SN	SNA
D101	0402-001098	DIODE-RECTIFIER	SK34,40V,3A,SMC,TP	
D201	0401-001116	DIODE-SWITCHING	BAV99DW,75V,150MA,SOT-363,TP	
D203	0401-001056	DIODE-SWITCHING	MMBD4148SE,75V,200MA,SOT-23,TP	
D212	0403-000579	DIODE-ZENER	BZX84C5V1,5.1V,5%,200mW,SOT-23	
D213	0403-000579	DIODE-ZENER	BZX84C5V1,5.1V,5%,200mW,SOT-23	
D214	0403-001435	DIODE-ZENER	QZX363C5V6,5.32-5.88,200MW,SOT-363,TP	
D215	0403-000579	DIODE-ZENER	BZX84C5V1,5.1V,5%,200mW,SOT-23	
D216	0403-000579	DIODE-ZENER	BZX84C5V1,5.1V,5%,200mW,SOT-23	
D602	0403-001435	DIODE-ZENER	QZX363C5V6,5.32-5.88,200MW,SOT-363,TP	
D603	0403-001435	DIODE-ZENER	QZX363C5V6,5.32-5.88,200MW,SOT-363,TP	
FT101	3301-001145	CORE-FERRITE BEAD	AB,4.5x1.6x1.6mm,-,-	SNA
FT102	3301-001145	CORE-FERRITE BEAD	AB,4.5x1.6x1.6mm,-,-	SNA
FT198	3301-001145	CORE-FERRITE BEAD	AB,4.5x1.6x1.6mm,-,-	SNA
FT199	3301-001145	CORE-FERRITE BEAD	AB,4.5x1.6x1.6mm,-,-	SNA
FT402	3301-001145	CORE-FERRITE BEAD	AB,4.5x1.6x1.6mm,-,-	SNA
FT403	3301-001145	CORE-FERRITE BEAD	AB,4.5x1.6x1.6mm,-,-	SNA
FT404	3301-001145	CORE-FERRITE BEAD	AB,4.5x1.6x1.6mm,-,-	SNA
FT405	3301-001145	CORE-FERRITE BEAD	AB,4.5x1.6x1.6mm,-,-	SNA
IC101	1203-001448	IC-SWITCH VOL. REG.	2596,TO-263,5P,-,PLASTIC,4.750	
IC103	1203-001293	IC-POSI.FIXED REG.	033,TO-252,3P,6.5MIL,PLASTIC,3	
IC104	1203-001890	IC-VOLTAGE REGULATOR	3961,SOT223-5,5P,-,PLASTIC,2.5V,-,-40to+125C,800mA,-,TR	
IC105	0505-001170	FET-SILICON	SI9933ADY-T1,P,-,20V,3.4A,0.06ohm,2W,SO-8	
IC199	1203-001293	IC-POSI.FIXED REG.	033,TO-252,3P,6.5MIL,PLASTIC,3	

Loc. No.	Code No.	Description	Specification	Remarks
IC201	1103-000129	IC-EEPROM	24C02,256x8BIT,SOP,8P,150MIL,1	
IC203	0803-000117	IC-TTL	74F14,INVERTER,SOP,14P,150MIL,	
IC301	1003-001506	IC-LCD CONTROLLER	GM2120,PDFP,208P,28X28MM,-,TR,PLASTIC,3.45V,OTO+70CC,1.6W,2.4V,SXGA LCD CONTRO	
IC302	1102-001097	IC-EPROM	27C010,128KX8BIT,PLCC,32P,-,90NS,5V,10%,PLASTIC,OTO+70C,0.1MA,CMOS,TR	
IC302 SOCK	3704-000249	SOCKET-IC	32P,PLCC,SN,1.27mm	
IC303	1203-001212	IC-VOL. DETECTOR	7029,SOT-89,3P,-,PLASTIC,-,500	
IC305	1103-001023	IC-EEPROM	524C80D81,1028x8BIT,SOP,8P,150MIL,10mS,5V,10%,PLASTIC,0to+70C,110uA,CMOS,TP	
IC401	1205-002174	IC-TRANSMITTER	NT7181,TSSOP,56P,236MIL,PLASTIC,3.45V,-,OTO+70C,TP,NT7181	
IC402	1205-002174	IC-TRANSMITTER	NT7181,TSSOP,56P,236MIL,PLASTIC,3.45V,-,OTO+70C,TP,NT7181	
JP10	2007-000090	R-CHIP	10KOHM,5%,1/16W,DA,TP,1608	
JP15	2007-000090	R-CHIP	10KOHM,5%,1/16W,DA,TP,1608	
JP9	2007-000090	R-CHIP	10KOHM,5%,1/16W,DA,TP,1608	
L100	2703-001778	INDUCTOR-SMD	3.3UH,20%,3.2X2.5X2.2MM	
L101	BN27-00008A	COIL CHOKE-SMD	SMD12*12*8.5,GH15/17PS,22.0UH,±20%,0.045OHM MAX,3.0A,DR10X7/SMD12X6.7,16.5TS	
L108	2703-001778	INDUCTOR-SMD	3.3UH,20%,3.2X2.5X2.2MM	
L109	2703-001778	INDUCTOR-SMD	3.3UH,20%,3.2X2.5X2.2MM	
L110	2703-001778	INDUCTOR-SMD	3.3UH,20%,3.2X2.5X2.2MM	
L111	2703-001778	INDUCTOR-SMD	3.3UH,20%,3.2X2.5X2.2MM	
L112	2703-001778	INDUCTOR-SMD	3.3UH,20%,3.2X2.5X2.2MM	
MP1.0	BN41-00190A	PCB MAIN	MO17ES,FR4,4L,120X110X1.0,MO17ES	
Q101	0501-000342	TR-SMALL SIGNAL	KSC1623-Y,NPN,200mW,SOT-23,TP,135-270	
Q102	0501-000342	TR-SMALL SIGNAL	KSC1623-Y,NPN,200mW,SOT-23,TP,135-270	
Q201	0501-000342	TR-SMALL SIGNAL	KSC1623-Y,NPN,200mW,SOT-23,TP,135-270	
R101	2007-000084	R-CHIP	4.7Kohm,5%,1/16W,DA,TP,1608	
R105	2007-000090	R-CHIP	10KOHM,5%,1/16W,DA,TP,1608	
R106	2007-000090	R-CHIP	10KOHM,5%,1/16W,DA,TP,1608	
R107	2007-000084	R-CHIP	4.7Kohm,5%,1/16W,DA,TP,1608	
R108	2007-000090	R-CHIP	10KOHM,5%,1/16W,DA,TP,1608	
R109	2007-000078	R-CHIP	1Kohm,5%,1/16W,DA,TP,1608	
R190	2007-000090	R-CHIP	10KOHM,5%,1/16W,DA,TP,1608	
R197	2007-000084	R-CHIP	4.7Kohm,5%,1/16W,DA,TP,1608	
R198	2007-000078	R-CHIP	1Kohm,5%,1/16W,DA,TP,1608	
R199	2007-000090	R-CHIP	10KOHM,5%,1/16W,DA,TP,1608	
R201	2007-000074	R-CHIP	100ohm,5%,1/16W,DA,TP,1608	
R202	2007-000074	R-CHIP	100ohm,5%,1/16W,DA,TP,1608	
R203	2007-000074	R-CHIP	100ohm,5%,1/16W,DA,TP,1608	
R204	2007-000074	R-CHIP	100ohm,5%,1/16W,DA,TP,1608	
R205	2007-000074	R-CHIP	100ohm,5%,1/16W,DA,TP,1608	
R206	2007-000074	R-CHIP	100ohm,5%,1/16W,DA,TP,1608	
R207	2007-001164	R-CHIP	75ohm,1%,1/16W,DA,TP,1608	
R208	2007-001164	R-CHIP	75ohm,1%,1/16W,DA,TP,1608	
R209	2007-001164	R-CHIP	75ohm,1%,1/16W,DA,TP,1608	
R218	2007-000092	R-CHIP	15Kohm,5%,1/16W,DA,TP,1608	
R219	2007-000092	R-CHIP	15Kohm,5%,1/16W,DA,TP,1608	
R220	2007-000074	R-CHIP	100ohm,5%,1/16W,DA,TP,1608	
R221	2007-000074	R-CHIP	100ohm,5%,1/16W,DA,TP,1608	
R222	2007-000090	R-CHIP	10KOHM,5%,1/16W,DA,TP,1608	
R223	2007-000080	R-CHIP	2Kohm,5%,1/16W,DA,TP,1608	
R224	2007-000074	R-CHIP	100ohm,5%,1/16W,DA,TP,1608	
R236	2007-000078	R-CHIP	1Kohm,5%,1/16W,DA,TP,1608	
R237	2007-000090	R-CHIP	10KOHM,5%,1/16W,DA,TP,1608	
R252	2007-000084	R-CHIP	4.7Kohm,5%,1/16W,DA,TP,1608	
R270	2007-000070	R-CHIP	0ohm,5%,1/16W,DA,TP,1608	

Loc. No.	Code No.	Description	Specification	Remarks
R302	2007-001935	R-CHIP	820ohm,5%,1/16W,DA,BK,1608	
R321	2007-000090	R-CHIP	10KOHM,5%,1/16W,DA,TP,1608	
R322	2007-000090	R-CHIP	10KOHM,5%,1/16W,DA,TP,1608	
R324	2007-000090	R-CHIP	10KOHM,5%,1/16W,DA,TP,1608	
R329	2007-000090	R-CHIP	10KOHM,5%,1/16W,DA,TP,1608	
R330	2007-000090	R-CHIP	10KOHM,5%,1/16W,DA,TP,1608	
R331	2007-000074	R-CHIP	100ohm,5%,1/16W,DA,TP,1608	
R334	2007-000074	R-CHIP	100ohm,5%,1/16W,DA,TP,1608	
R350	2007-000092	R-CHIP	15Kohm,5%,1/16W,DA,TP,1608	
R353	2007-000074	R-CHIP	100ohm,5%,1/16W,DA,TP,1608	
R354	2007-000074	R-CHIP	100ohm,5%,1/16W,DA,TP,1608	
R357	2007-000077	R-CHIP	470ohm,5%,1/16W,DA,TP,1608	
R358	2007-000077	R-CHIP	470ohm,5%,1/16W,DA,TP,1608	
R359	2007-000077	R-CHIP	470ohm,5%,1/16W,DA,TP,1608	
R360	2007-000074	R-CHIP	100ohm,5%,1/16W,DA,TP,1608	
R361	2007-001167	R-CHIP	75ohm,5%,1/16W,DA,TP,1608	
R362	2007-001167	R-CHIP	75ohm,5%,1/16W,DA,TP,1608	
R363	2007-001167	R-CHIP	75ohm,5%,1/16W,DA,TP,1608	
R364	2007-000074	R-CHIP	100ohm,5%,1/16W,DA,TP,1608	
R365	2007-000090	R-CHIP	10KOHM,5%,1/16W,DA,TP,1608	
R366	2007-000074	R-CHIP	100ohm,5%,1/16W,DA,TP,1608	
R391	2007-000074	R-CHIP	100ohm,5%,1/16W,DA,TP,1608	
R392	2007-000090	R-CHIP	10KOHM,5%,1/16W,DA,TP,1608	
R395	2007-000074	R-CHIP	100ohm,5%,1/16W,DA,TP,1608	
R396	2007-000090	R-CHIP	10KOHM,5%,1/16W,DA,TP,1608	
R399	2007-000090	R-CHIP	10KOHM,5%,1/16W,DA,TP,1608	
R410	2007-000070	R-CHIP	0ohm,5%,1/16W,DA,TP,1608	
R411	2007-000072	R-CHIP	47ohm,5%,1/16W,DA,TP,1608	
R412	2007-000072	R-CHIP	47ohm,5%,1/16W,DA,TP,1608	
R413	2007-000072	R-CHIP	47ohm,5%,1/16W,DA,TP,1608	
R414	2007-000072	R-CHIP	47ohm,5%,1/16W,DA,TP,1608	
R415	2007-000072	R-CHIP	47ohm,5%,1/16W,DA,TP,1608	
R416	2007-000072	R-CHIP	47ohm,5%,1/16W,DA,TP,1608	
R417	2007-000072	R-CHIP	47ohm,5%,1/16W,DA,TP,1608	
R418	2007-000072	R-CHIP	47ohm,5%,1/16W,DA,TP,1608	
R419	2007-000072	R-CHIP	47ohm,5%,1/16W,DA,TP,1608	
R420	2007-000072	R-CHIP	47ohm,5%,1/16W,DA,TP,1608	
R421	2007-000070	R-CHIP	0ohm,5%,1/16W,DA,TP,1608	
R601	2007-000090	R-CHIP	10KOHM,5%,1/16W,DA,TP,1608	
R602	2007-000090	R-CHIP	10KOHM,5%,1/16W,DA,TP,1608	
R603	2007-000090	R-CHIP	10KOHM,5%,1/16W,DA,TP,1608	
R604	2007-000090	R-CHIP	10KOHM,5%,1/16W,DA,TP,1608	
R605	2007-000090	R-CHIP	10KOHM,5%,1/16W,DA,TP,1608	
R606	2007-000090	R-CHIP	10KOHM,5%,1/16W,DA,TP,1608	
R607	2007-000074	R-CHIP	100ohm,5%,1/16W,DA,TP,1608	
R608	2007-000074	R-CHIP	100ohm,5%,1/16W,DA,TP,1608	
R609	2007-000074	R-CHIP	100ohm,5%,1/16W,DA,TP,1608	
R610	2007-000074	R-CHIP	100ohm,5%,1/16W,DA,TP,1608	
R612	2007-000074	R-CHIP	100ohm,5%,1/16W,DA,TP,1608	
R617	2007-000074	R-CHIP	100ohm,5%,1/16W,DA,TP,1608	
R626	2007-000074	R-CHIP	100ohm,5%,1/16W,DA,TP,1608	
R627	2007-000074	R-CHIP	100ohm,5%,1/16W,DA,TP,1608	
R690	2007-000072	R-CHIP	47ohm,5%,1/16W,DA,TP,1608	

Loc. No.	Code No.	Description	Specification	Remarks
R691	2007-000072	R-CHIP	47ohm,5%,1/16W,DA,TP,1608	
R692	2007-000072	R-CHIP	47ohm,5%,1/16W,DA,TP,1608	
R693	2007-000072	R-CHIP	47ohm,5%,1/16W,DA,TP,1608	
R694	2007-000072	R-CHIP	47ohm,5%,1/16W,DA,TP,1608	
R695	2007-000072	R-CHIP	47ohm,5%,1/16W,DA,TP,1608	
R696	2007-000072	R-CHIP	47ohm,5%,1/16W,DA,TP,1608	
R697	2007-000072	R-CHIP	47ohm,5%,1/16W,DA,TP,1608	
R698	2007-000072	R-CHIP	47ohm,5%,1/16W,DA,TP,1608	
R699	2007-000072	R-CHIP	47ohm,5%,1/16W,DA,TP,1608	
R709	2007-000070	R-CHIP	0ohm,5%,1/16W,DA,TP,1608	
RA301	2011-001193	R-NETWORK	68ohm,5%,1/16W,L,CHIP,8P,TP	
RA302	2011-001193	R-NETWORK	68ohm,5%,1/16W,L,CHIP,8P,TP	
RA303	2011-001410	R-NETWORK	1200HM,5%,1/16W,L,CHIP,8P,TP	
RA304	2011-001410	R-NETWORK	1200HM,5%,1/16W,L,CHIP,8P,TP	
RA305	2011-001410	R-NETWORK	1200HM,5%,1/16W,L,CHIP,8P,TP	
RA306	2011-001410	R-NETWORK	1200HM,5%,1/16W,L,CHIP,8P,TP	
RA307	2011-001410	R-NETWORK	1200HM,5%,1/16W,L,CHIP,8P,TP	
RA308	2011-001410	R-NETWORK	1200HM,5%,1/16W,L,CHIP,8P,TP	
RA309	2011-001410	R-NETWORK	1200HM,5%,1/16W,L,CHIP,8P,TP	
RA310	2011-001410	R-NETWORK	1200HM,5%,1/16W,L,CHIP,8P,TP	
RA311	2011-001410	R-NETWORK	1200HM,5%,1/16W,L,CHIP,8P,TP	
RA312	2011-001410	R-NETWORK	1200HM,5%,1/16W,L,CHIP,8P,TP	
RA313	2011-001410	R-NETWORK	1200HM,5%,1/16W,L,CHIP,8P,TP	
RA314	2011-001410	R-NETWORK	1200HM,5%,1/16W,L,CHIP,8P,TP	
X301	2801-003667	CRYSTAL-SMD	14.3182MHZ,50PPM,28-AAN,16,500HM,TP	

6-2-2 MO17E* Others

Loc. No.	Code No.	Description	Specification	Remarks
-	BN90-00386A	ASSY COVER REAR	MO17PS	
CIS	BN96-00143A	ASSY COVER P-REAR	MO17PS/ES,ABS HB,BK07	
C/R	BN63-00350A	COVER-REAR	MO17PS,ABS HB,BK07	
C/R	BN73-00020A	RUBBER-FOOT	MO15PS/ES,RUBBER,T 1.5,BLK	SNA
-	BN90-00390A	ASSY COVER FRONT	MO17ES	
C/F+C/R	6003-000282	SCREW-TAPTITE	BH,+ ,B,M3,L8,ZPC(BLK),SWCH10	SNA
CIS	BN96-00102B	ASSY COVER P-FRONT	MO17ES,ABS HB,BK07	
C/F	6003-000117	SCREW-TAPTITE	BH,+ ,B,M3,L6,ZPC(YEL),SWRCH18A	SNA
C/F	BN59-00310A	BOARD-FUNCTION ASS'Y	MO17PS,FUNCTION ASS'Y	
C/F	BN63-00349A	COVER-FRONT	MO17PS,ABS HB,BK07	
C/F	BN64-00052A	KNOB-FUNCTION	MO15PS,ABS+PC,-,-,-,-,-,MO15PS	SNA
C/F	BN67-00036A	LENS-LED	MO15PS,ACRYL,CLEAR,-,-,-,MO15PS	
-	BN90-00391A	ASSY STAND	MO17ES	
CIS	BN96-00104B	ASSY STAND P	MO17ES,ABS HB,BK07	
STD	6002-000129	SCREW-TAPPING	FH,+ ,2S,M3,L8,ZPC(BLK),SM20C	SNA
STD	6003-000117	SCREW-TAPTITE	BH,+ ,B,M3,L6,ZPC(YEL),SWRCH18A	SNA
STD	6003-000301	SCREW-TAPTITE	BH,+ ,S,M4,L6,ZPC(YEL),SWRCH18A	SNA
STD	6003-001188	SCREW-TAPTITE	BH,+ ,B,M4,L10,YEL,SWRCH18A	SNA
STD	6011-001445	BOLT-SOCKET	4-40 UNC,L7,NI PLT,BRASS,HEX SOCKET	SNA
STD	6501-000113	CABLE TIE	DA-100,T1,W2.5,L102,WHT,NYLON	
STD	BN39-00298A	LEAD CONNECTOR	MO17ES,UL20276#32,UL/CSA,15P/20P,#32,DC-JACK/DSUB,12507HS-20,BK,260MM,20276#32,C	
STD	BN61-00187B	BRACKET-BOTTOM	MO17ES,SECC,T2.0	
STD	BN63-00354A	COVER-NECK/FRONT	MO17PS,ABS HB,BK07	
STD	BN63-00355A	COVER-NECK/REAR	MO17PS,ABS HB,BK07	
STD	BN63-00356A	COVER-BASE/BOTTOM	MO17PS,ABS HB,BK07	
STD	BN63-00357A	COVER-BASE/TOP	MO17PS,ABS HB,BK07	
STD	BN96-00105A	ASSY STAND P-HINGE	MO17PS,ZNDC	
-	BN91-00388Q	ASSY LCD	MO17PS	SNA
CIS	BN07-00071A	LCD	LTM170EU-L01,GH17LS,1280*1024,358.5*296.5*17,16.19M,56.0,264*0.264,0-55.5,0,TN,-	
-	BN91-00388R	ASSY LCD	MO17PS	SNA
CIS	BN07-00075A	LCD	LTM170E6-L02,GH17LS,1280*1024,358.5*296.5*17,16.19M,56.0,264*0.264,0-55.5,0,TN,-	
-	BN91-00472A	ASSY SHIELD	MO17PS	SNA
IN/PCB+PAN	6001-000125	SCREW-MACHINE	BH,+ ,M3,L4,ZPC(YEL),SM20C,-	SNA
M/PCB+PAN	6001-000125	SCREW-MACHINE	BH,+ ,M3,L4,ZPC(YEL),SM20C,-	SNA
HIN/TOP+SH/PCB	6003-000133	SCREW-TAPTITE	BH,+ ,S,M4,L8,ZPC(YEL),SWRCH 18	SNA
SH/PCB+C/F	6003-000282	SCREW-TAPTITE	BH,+ ,B,M3,L8,ZPC(BLK),SWCH10	SNA
CIS	BN39-00244B	CBF SIGNAL	MO15PS,15P/15P,20276-N,1830MM,UL20276,BLACK,D-SUB/MALE,DET. TYPE	
CIS	BN39-00292A	LEAD CONNECTOR	MO17PS,UL1571#30,UL/CSA,30P,#30,12507HS-30,FI-X30H,BK,90MM,1571#30,CORE	
CIS	BN39-00293A	LEAD CONNECTOR	MO17PS,UL2651#28,UL/CSA,10P,#28,12505HS-10,12505HS-10,BK,100MM,2651#28,CORE	
CIS	BN63-00351A	COVER-DOOR	MO17PS,ABS HB,BK07	
CIS	BN63-00353A	SHIELD-CONNECTOR	MO17PS,SPT,E,T0.3	
CIS	BN96-00103A	ASSY COVER P-SHIELD	,SECC T1.0	
-	BN91-00473A	ASSY MISC-ADAPTOR	MO17PS	SNA
CIS	BN44-00058A	ADAPTOR	PSCV420106(AD-4214N,GH17PS ,100 TO 240 VAC,47 - 63 HZ,+14VDC,3A,-,42W,AC-DC,0 T	
-	BN91-00474A	ASSY CHASSIS	MO17ES	
-	BN92-00554A	ASSY BOX	MO17ES	SNA

Loc. No.	Code No.	Description	Specification	Remarks
CIS	BH68-00329C	LABEL BAR CODE	-,ALL,TCO99,DOMESTIC,ART-PAPER 90G,-,WHT,BLACK,-,-,-	SNA
CIS	BH75-10529C	UNIT-HANDLE/PACKING	S/M170MP,PE-LD,PE-HD,-,WHITE,-	SNA
CIS	BN72-60001A	LEVER TOP	LSD210TL,PE-LD,WHITE,TFT_LCD	SNA
CIS	BN72-60002C	LEVER BOTTOM	S/M170MP,PE-HD,BLUE	SNA
CIS	BN69-00371A	BOX	S/M172B,W/W,CB-SW4,WHT,OFFSET,A-1,L473*W399*H122	SNA
-	BN92-00555A	ASSY LABEL	M017ES	SNA
CIS	BN68-00310B	LABEL RATING	M017ES,EDC,SYNC,PE,T0.05,90,45,PE NATURE,SILVER/GUNMETAL	SNA
-	BN92-00556A	ASSY ACCESSORY	M017ES	SNA
-	BN92-00557A	ASSY P/MATERIAL	M017ES	SNA
P/M	0203-001100	TAPE-OPP MASKING	OPP/W75/CLR,T0.05,W75,L800000,CLR	SNA
P/M	BH69-00328B	PAD-EDGE	ML17,DW3,200,1370,-,-,YEL,-,-	SNA
P/M	BH69-00457C	PACKING-PAD	CY15PO,FOAM,T3.0,1320,880	SNA
P/M	BH69-30355C	BAG-FPD	HDPE+PE FOAM,0.02+0.5,-,Y(24)-,IBM	SNA
P/M	BH69-40379A	PACKING-WRAP	LDPE,W500*T0.02,-,-	SNA
P/M	BN69-00131P	PALLET-PACKING	M017,WOODEN,1462,830,120	SNA
P/M	BN69-00140M	PAD-PALLET COVER	IBM15,SW,800*3540,1295,-,-,-,-,-	SNA
P/M	BN69-00140V	PAD-PALLET COVER	RB15AS,SW4,1200,3530,-,-,-,-,-	SNA
P/M	BN69-00300A	CUSHION-EPE	M015PS/ES,SHEET EPS,T5.0	SNA
P/M	BN69-00327A	CUSHION-R/L	M017PS,EPS,M50	SNA

Memo

4-2-1 No Video [Analog]

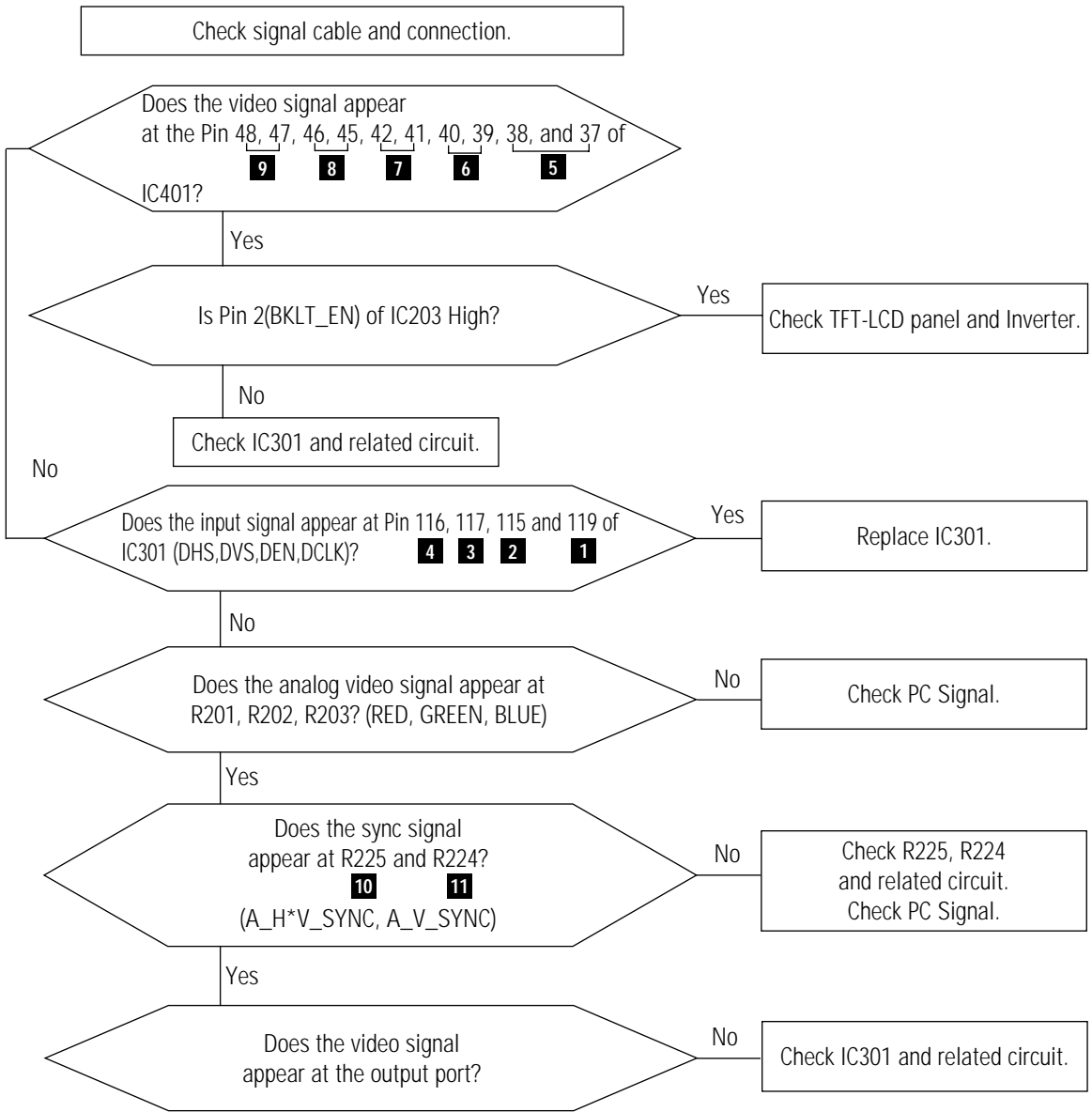

4-2-2 No Video [Digital]

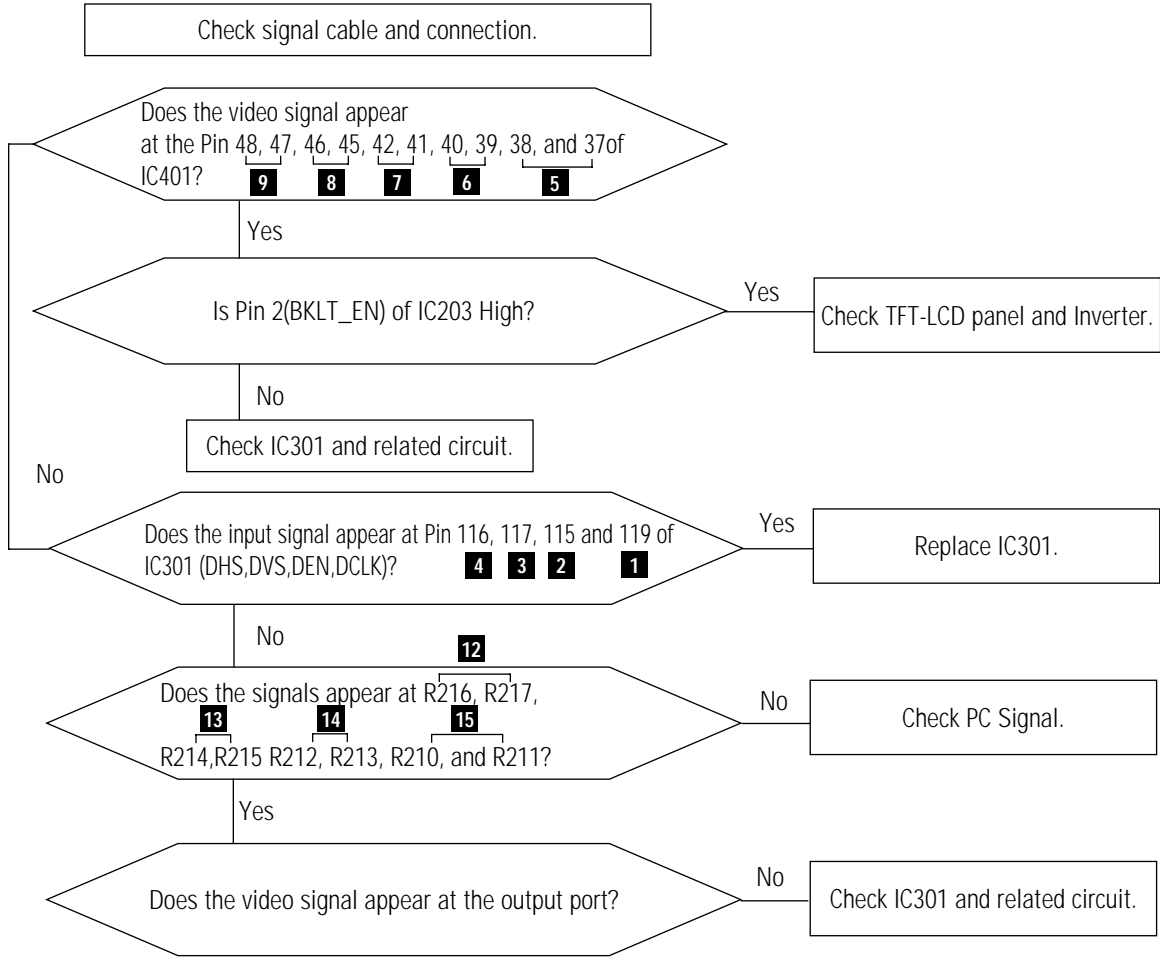

WAVEFORMS

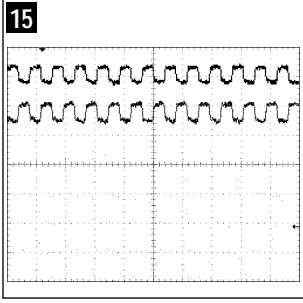
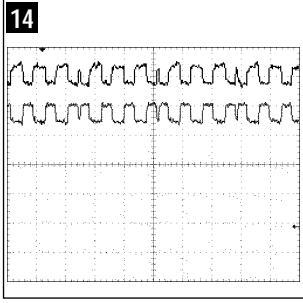
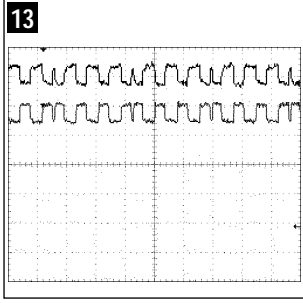
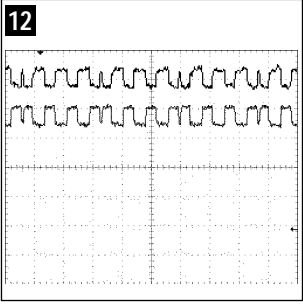
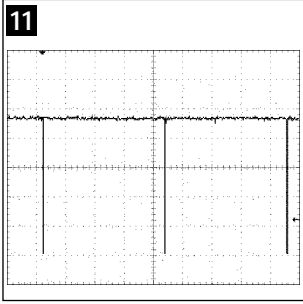
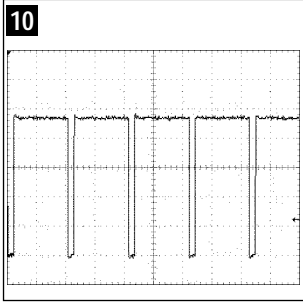
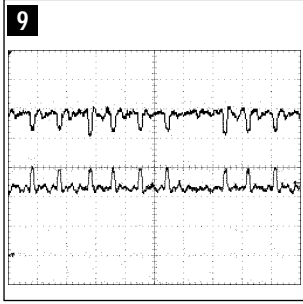
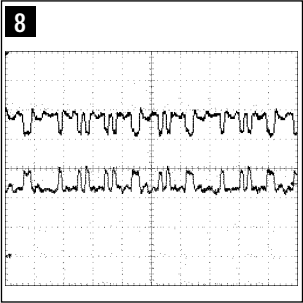
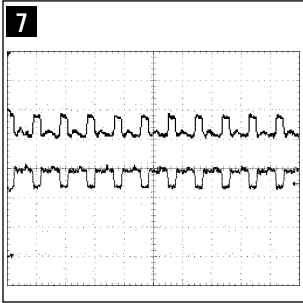
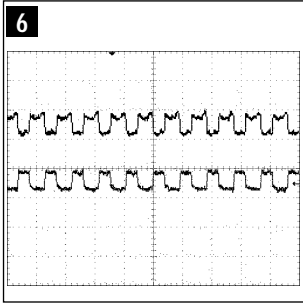
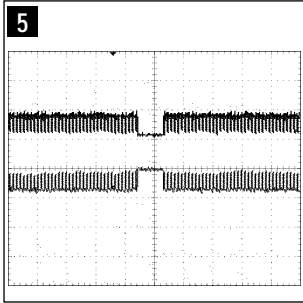
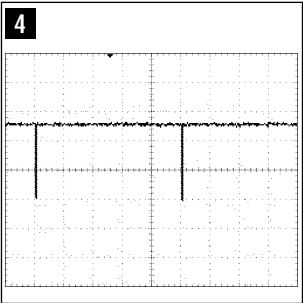
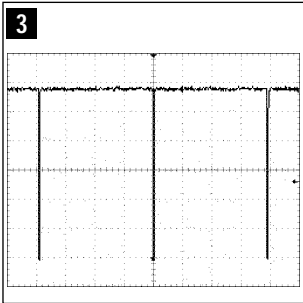
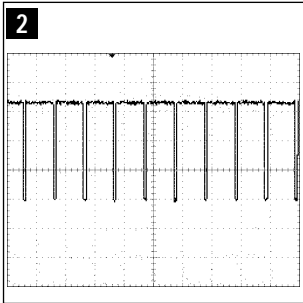
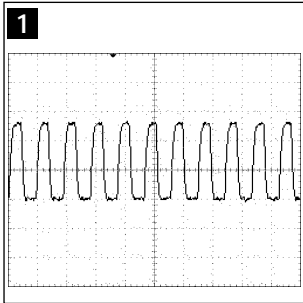

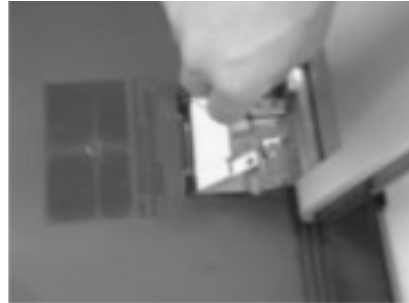
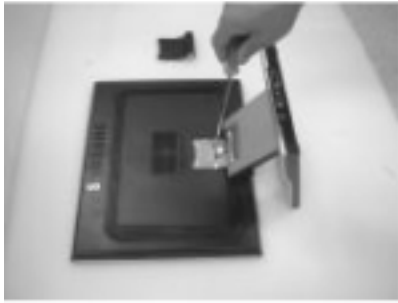

- 4. Remove 2 screws on the hinge mounting.
Do not remove the screw for cable clamp.



- 5. Disconnect the stand cable from socket and remove stand assembly.



- 6. Remove 2 screws of cover rear.



- 7. Open the cover rear by using opening jig.

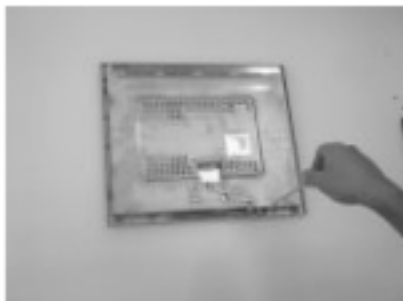

- 8. Remove screws around bracket panel and pull out function wire from socket.

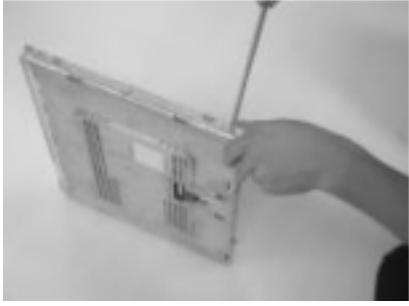

9. Seperate shield ass'y and panel ass'y.

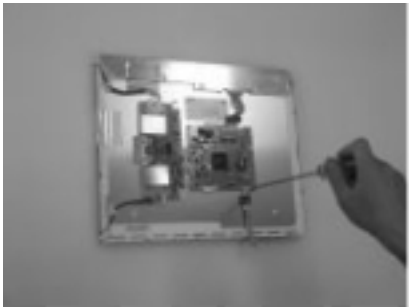

10. Remove screws on main board and inverter board.

3-2 Replacement Order of Lamp Assemblies

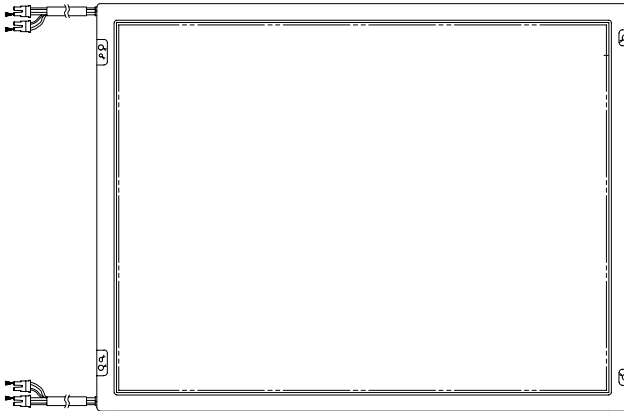

1. After confirm there is nothing on the disk
Turn the LCD module over and put it on a flat desk set to the ground.

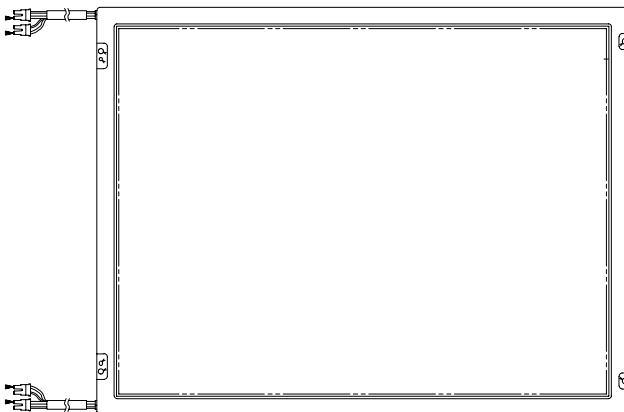

2. Push down the stopper and slide the lamp unit.

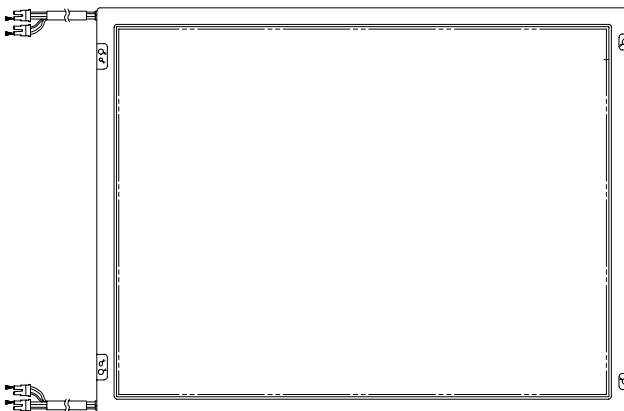

3. Please take out the lamp unit from the LCD module.

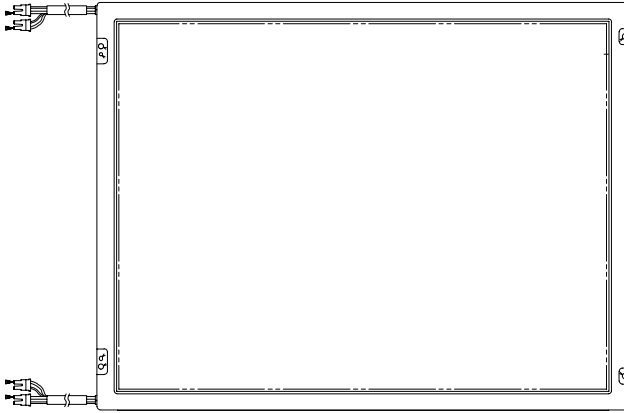

4. Please fix the new lamp units on the LCD module : opposite process 2 and 3

* Replacement of lamp unit should be done at the power off state and recommended clean bench condition.

3-3 Reassembly

Reassembly procedures are in the reverse order of Disassembly procedures.

Memo

2-2 Pin Assignments

Pin No.	Sync Type	15-Pin D-Sub Signal Cable Connector		
		Separate	Composite	Sync-on-green
1		Red video	Red video	Red
2		Green video	Green video	Green video + H/V Sync.
3		Blue video	Blue video	Blue video
4		GND	GND	GND
5		GND (DDC Return)	GND (DDC Return)	GND (DDC Return)
6		Red video GND	Red video GND	Red video GND
7		Green video GND	Green video GND	Green video GND
8		Blue video GND	Blue video GND	Blue video GND
9		No Connection	No Connection	Not Used
10		Sync.-GND/Self Test	Sync.-GND/Self Test	GND-Sync./Self Test
11		GND	GND	GND
12		DDC Data	DDC Data	DDC Data
13		H-Sync.	H/V-Sync.	Not Used
14		V-Sync.	Not Used	Not Used
15		DDC Clock	DDC Clock	DDC Clock

Pin No.	Sync Type	24-Pin DVI-D(TMDS)		
1		Rx2-	13	No Connection
2		Rx2+	14	DDC Power Input (+5V)
3		GND	15	Self Raster
4		No Connection	16	Connection Signal Output (+5V)
5		No Connection	17	Rx0-
6		DDC Clock (SCL)	18	Rx0+
7		DDC Data (SDA)	19	GND
8		No Connection	20	No Connection
9		Rx1-	21	No Connection
10		Rx1+	22	GND
11		GND	23	RxC+
12		No Connection	24	RxC-

2-3 Timing Chart

This section of the service manual describes the timing that the computer industry recognizes as standard for computer-generated video signals.

2-3-1 LCD Panel Mode : 1 mode

Timing No.	20
Originator	VESA
Mode Name	1280/60Hz
Resolution (HxV)	1280x1024
HORIZONTAL	
Frequency	63.981kHz
Total time	11.852 μ s
Active time	9.259 μ s
Blank time	3.778 μ s
Border (L / R)	0.000 μ s
Data time	9.259 μ s
Front porch	0.444 μ s
Sync. width	1.037 μ s
Back porch	2.296 μ s
Sync. polarity	Positive
VERTICAL	
Frequency	60.020Hz
Total time	16.005ms
Active time	15.630ms
Blank time	0.375ms
Border (T / B)	0.000ms
Data time	15.630ms
Front porch	0.016ms
Sync. width	0.047ms
Back porch	0.594ms
Sync. polarity	Positive
Dot Clock	108.00MHz
Sync. Type	Separate
Scan Type	N/I

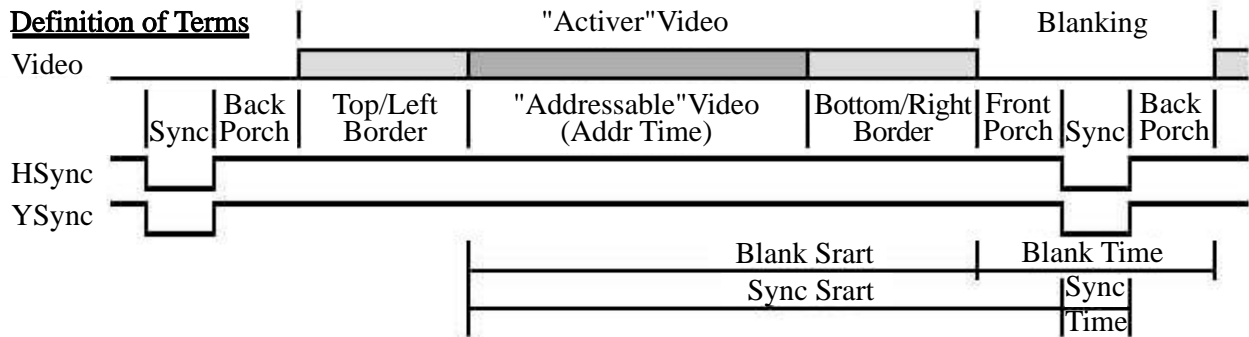

2-3-2 Supported Modes (1)

Timing No. Originator Mode Name Resolution (HxV)	1 IBM VGA1 640x350	2 IBM VGA2 720x400	3 IBM VGA3 640x480	11 VESA 640/72Hz 640x480	17 VESA 640/75Hz 640x480
HORIZONTAL					
Frequency	31.469kHz	31.469kHz	31.469kHz	37.861kHz	37.500kHz
Total time	31.778 μ s	31.777 μ s	31.778 μ s	26.413 μ s	26.667 μ s
Active time	26.058 μ s	26.058 μ s	26.058 μ s	20.825 μ s	20.317 μ s
Blank time	5.720 μ s	5.720 μ s	5.720 μ s	5.588 μ s	6.350 μ s
Border (L / R)	0.318 μ s	0.318 μ s	0.318 μ s	0.254 μ s	0.000 μ s
Data time	25.422 μ s	25.422 μ s	25.422 μ s	20.317 μ s	20.317 μ s
Front porch	0.318 μ s	0.318 μ s	0.318 μ s	0.508 μ s	0.508 μ s
Sync. width	3.813 μ s	3.813 μ s	3.813 μ s	1.270 μ s	2.032 μ s
Back porch	1.589 μ s	1.589 μ s	1.589 μ s	3.810 μ s	3.810 μ s
Sync. polarity	Positive	Negative	Negative	Negative	Negative
VERTICAL					
Frequency	70.086Hz	70.087Hz	59.940Hz	72.809Hz	75.000Hz
Total time	14.268ms	14.268ms	16.683ms	13.735ms	13.333ms
Active time	11.504ms	13.155ms	15.761ms	13.100ms	12.800ms
Blank time	2.764ms	1.113ms	0.922ms	0.635ms	0.533ms
Border (T / B)	0.191ms	0.222ms	0.254ms	0.211ms	0.000ms
Data time	11.122ms	12.711ms	15.253ms	12.678ms	12.800ms
Front porch	0.985ms	0.191ms	0.064ms	0.026ms	0.027ms
Sync. width	0.064ms	0.064ms	0.064ms	0.079ms	0.080ms
Back porch	1.716ms	0.858ms	0.794ms	0.528ms	0.427ms
Sync. polarity	Negative	Positive	Negative	Negative	Negative
Dot Clock	25.175MHz	28.322MHz	25.175MHz	31.500MHz	31.500MHz
Sync. Type	Separate	Separate	Separate	Separate	Separate
Scan Type	N/I	N/I	N/I	N/I	N/I

2-3-2 Supported Modes (2)

Timing No.	32	33	12	13	14
Originator	MAC	MAC	VESA	VESA	VESA
Mode Name	640/67Hz	832/75Hz	800/56Hz	800/60Hz	800/72Hz
Resolution (HxV)	640x480	832x624	800x600	800x600	800x600
HORIZONTAL					
Frequency	35.000kHz	49.726kHz	35.156kHz	37.879kHz	48.077kHz
Total time	28.571 μ s	20.110 μ s	28.444 μ s	26.400 μ s	20.800 μ s
Active time	21.164 μ s	14.524 μ s	22.222 μ s	20.000 μ s	16.000 μ s
Blank time	7.407 μ s	5.586 μ s	6.222 μ s	6.400 μ s	4.800 μ s
Border (L / R)	0.000 μ s	0.000 μ s	0.000 μ s	0.000 μ s	0.000 μ s
Data time	21.164 μ s	14.524 μ s	22.222 μ s	20.000 μ s	16.000 μ s
Front porch	2.116 μ s	0.559 μ s	0.667 μ s	1.000 μ s	1.120 μ s
Sync. width	2.116 μ s	1.117 μ s	2.000 μ s	3.200 μ s	2.400 μ s
Back porch	3.175 μ s	3.910 μ s	3.556 μ s	2.200 μ s	1.280 μ s
Sync. polarity	Negative	Negative	Positive or Negative	Positive	Positive
VERTICAL					
Frequency	66.667Hz	74.551Hz	56.250Hz	60.317Hz	72.188Hz
Total time	15.000ms	13.414ms	17.778ms	16.579ms	13.853ms
Active time	13.714ms	12.549ms	17.067ms	15.840ms	12.480ms
Blank time	1.286ms	0.865ms	0.711ms	0.739ms	1.373ms
Border (T / B)	0.000ms	0.000ms	0.000ms	0.000ms	0.000ms
Data time	13.714ms	12.549ms	17.067ms	15.840ms	12.480ms
Front porch	0.086ms	0.020ms	0.028ms	0.026ms	0.770ms
Sync. width	0.086ms	0.060ms	0.057ms	0.106ms	0.125ms
Back porch	1.114ms	0.784ms	0.626ms	0.607ms	0.478ms
Sync. polarity	Negative	Negative	Positive or Negative	Positive	Positive
Dot Clock	30.240MHz	57.284MHz	36.000MHz	40.000MHz	50.000MHz
Sync. Type	Separate Composite	Separate Composite	Separate	Separate	Separate
Scan Type	Sync.-on-G N/I	Sync.-on-G N/I	N/I	N/I	N/I

2-3-2 Supported Modes (3)

Timing No.	18	15	16	19	20
Originator	VESA	VESA	VESA	VESA	VESA
Mode Name	800/75Hz	1024/60Hz	1024/70Hz	1024/75Hz	1280/75Hz
Resolution (HxV)	800x600	1024x768	1024x768	1024x768	1280x1024
HORIZONTAL					
Frequency	46.875kHz	48.363kHz	56.476kHz	60.023kHz	79.976kHz
Total time	21.333 μ s	20.677 μ s	17.707 μ s	16.660 μ s	12.504 μ s
Active time	16.162 μ s	15.754 μ s	13.653 μ s	13.003 μ s	9.481 μ s
Blank time	5.171 μ s	4.923 μ s	4.054 μ s	3.657 μ s	3.023 μ s
Border (L / R)	0.000 μ s	0.000 μ s	0.000 μ s	0.000 μ s	0.000 μ s
Data time	16.162 μ s	15.754 μ s	13.653 μ s	13.003 μ s	9.481 μ s
Front porch	0.323 μ s	0.369 μ s	0.320 μ s	0.203 μ s	0.119 μ s
Sync. width	1.616 μ s	2.092 μ s	1.813 μ s	1.219 μ s	1.067 μ s
Back porch	3.232 μ s	2.462 μ s	1.920 μ s	2.235 μ s	1.837 μ s
Sync. polarity	Positive	Negative	Negative	Positive	Positive
VERTICAL					
Frequency	75.000Hz	60.004Hz	70.069Hz	75.029Hz	75.025Hz
Total time	13.333ms	16.666ms	14.272ms	13.328ms	13.329ms
Active time	12.800ms	15.880ms	13.599ms	12.795ms	12.804ms
Blank time	0.533ms	0.786ms	0.673ms	0.533ms	0.525ms
Border (T / B)	0.000ms	0.000ms	0.000ms	0.000ms	0.000ms
Data time	12.800ms	15.880ms	13.599ms	12.795ms	12.804ms
Front porch	0.021ms	0.062ms	0.053ms	0.017ms	0.013ms
Sync. width	0.064ms	0.124ms	0.106ms	0.050ms	0.038ms
Back porch	0.448ms	0.600ms	0.513ms	0.466ms	0.475ms
Sync. polarity	Positive	Negative	Negative	Positive	Positive
Dot Clock	49.500MHz	65.000MHz	75.000MHz	78.750MHz	135.00MHz
Sync. Type	Separate	Separate	Separate	Separate	Separate
Scan Type	N/I	N/I	N/I	N/I	N/I

2-3-2 Supported Modes (4)

Timing No.	
Originator	SUN
Mode Name	1280/76Hz
Resolution (HxV)	1280x1024
HORIZONTAL	
Frequency	81.129kHz
Total time	1664 pixels
Active time	1280 pixels
Blank time	
Border (L / R)	
Data time	
Front porch	32 pixels
Sync. width	64 pixels
Back porch	288 pixels
Sync. polarity	Negative
VERTICAL	
Frequency	76.106Hz
Total time	1066 pixels
Active time	1024 pixels
Blank time	
Border (T / B)	
Data time	
Front porch	2 pixels
Sync. width	8 pixels
Back porch	32 pixels
Sync. polarity	Negative
Dot Clock	135.00MHz
Sync. Type	Composite
Scan Type	N/I

Memo

1-2 Servicing Precautions

WARNING: An electrolytic capacitor installed with the wrong polarity might explode.

Caution: Before servicing units covered by this service manual, read and follow the Safety Precautions section of this manual.

Note: If unforeseen circumstances create conflict between the following servicing precautions and any of the safety precautions, always follow the safety precautions.

1-2-1 General Servicing Precautions

1. Always unplug the unit's AC power cord from the AC power source and disconnect the DC Power Jack before attempting to:
 - (a) remove or reinstall any component or assembly,
 - (b) disconnect PCB plugs or connectors, (c) connect a test component in parallel with an electrolytic capacitor.
2. Some components are raised above the printed circuit board for safety. An insulation tube or tape is sometimes used. The internal wiring is sometimes clamped to prevent contact with thermally hot components. Reinstall all such elements to their original position.
3. After servicing, always check that the screws, components and wiring have been correctly reinstalled. Make sure that the area around the serviced part has not been damaged.
4. Check the insulation between the blades of the AC plug and accessible conductive parts (examples: metal panels, input terminals and earphone jacks).
5. Insulation Checking Procedure: Disconnect the power cord from the AC source and turn the power switch ON. Connect an insulation resistance meter (500 V) to the blades of the AC plug.
The insulation resistance between each blade of the AC plug and accessible conductive parts (see above) should be greater than 1 megohm.
6. Always connect a test instrument's ground lead to the instrument chassis ground before connecting the positive lead; always remove the instrument's ground lead last.

1-3 Electrostatically Sensitive Devices (ESD) Precautions

Some semiconductor (solid state) devices can be easily damaged by static electricity. Such components are commonly called Electrostatically Sensitive Devices (ESD). Examples of typical ESD devices are integrated circuits and some field-effect transistors. The following techniques will reduce the incidence of component damage caused by static electricity.

1. Immediately before handling any semiconductor components or assemblies, drain the electrostatic charge from your body by touching a known earth ground. Alternatively, wear a discharging wrist-strap device. To avoid a shock hazard, be sure to remove the wrist strap before applying power to the monitor.
2. After removing an ESD-equipped assembly, place it on a conductive surface such as aluminum foil to prevent accumulation of an electrostatic charge.
3. Do not use freon-propelled chemicals. These can generate electrical charges sufficient to damage ESDs.
4. Use only a grounded-tip soldering iron to solder or desolder ESDs.
5. Use only an anti-static solder removal device. Some solder removal devices not classified as "anti-static" can generate electrical charges sufficient to damage ESDs.
6. Do not remove a replacement ESD from its protective package until you are ready to install it. Most replacement ESDs are packaged with leads that are electrically shorted together by conductive foam, aluminum foil or other conductive materials.
7. Immediately before removing the protective material from the leads of a replacement ESD, touch the protective material to the chassis or circuit assembly into which the device will be installed.
Caution: Be sure no power is applied to the chassis or circuit and observe all other safety precautions.
8. Minimize body motions when handling unpackaged replacement ESDs. Motions such as brushing clothes together, or lifting your foot from a carpeted floor can generate enough static electricity to damage an ESD.



Samsung Electronics Co.,Ltd.

416, Maetan-3Dong, Paldal-Gu, Suwon City, Kyungki-Do, Korea.

Printed in Korea

P/N : BN82-00074A-00

<http://www.samsungmonitor.com> (SyncMaster Worldwide)

<http://www.samsung-monitor.com> (SyncMaster USA)

<http://www.sec.co.kr/monitor> (Korea)