

UTC ULN2003 LINEAR INTEGRATED CIRCUIT

SEVEN DARLINGTON ARRAYS

DESCRIPTION

The UTC ULN2003 is high-voltage, high-current darlington drivers comprised of seven NPN darlington pairs.

FEATURES

- *Output current (single output) 500mA MAX.
- *High sustaining voltage output 50V MIN.
- *Output clamp diodes
- *Inputs compatible with various types of logic

APPLICATIONS

- *Relay, hammer, lamp and display (LED) drivers.

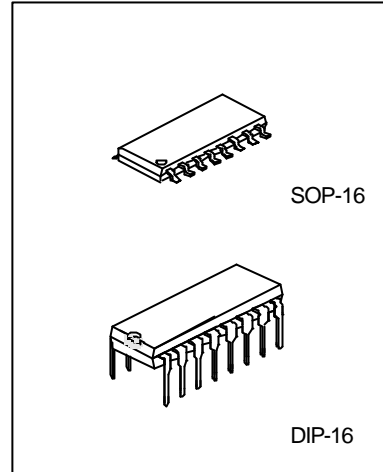

SCHEMATICS (EACH DRIVER)

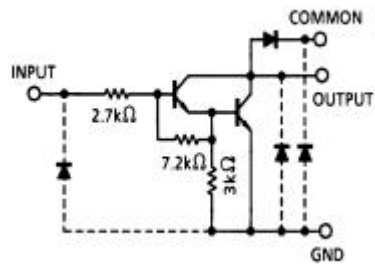

Note: The input and output parasitic diodes cannot be used as clamp diodes.

PIN CONFIGURATIONS

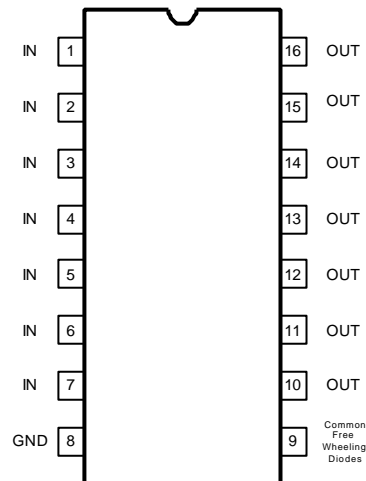

UTC ULN2003 LINEAR INTEGRATED CIRCUIT

ABSOLUTE MAXIMUM RATINGS

PARAMETER	SYMBOL	VALUE	UNIT
Input Voltage	V_{IN}	-0.5~30	V
Output Sustaining Voltage	$V_{CE(SUS)}$	-0.5~50	V
Output Current	I_{OUT}	500	mA/ch
Clamp Diode Reverse Voltage	V_R	50	V
Clamp Diode Forward Current	I_F	500	mA
Power Dissipation	P_D	DIP: 1.47 SOP: 0.54/0.625(Note)	W
Operating Ambient Temperature Range	T_{opr}	-40 to +85	°C
Storage Temperature Range	T_{stg}	-55 to +150	°C

Note: On glass epoxy PCB (30x30x1.6mm Cu 50%)

ELECTRICAL CHARACTERISTICS ($T_A = 25^\circ\text{C}$, Unless otherwise specified)

PARAMETER	SYMBOL	TEST CONDITIONS	MIN	TYP	MAX	UNIT	FIG
Output Leakage Current	I_{CEX}	$V_{CE}=50\text{V}, T_A=25^\circ\text{C}$ $V_{CE}=50\text{V}, T_A=85^\circ\text{C}$			50 100	μA	1
Collector-Emitter Saturation Voltage	$V_{CE(SAT)}$	$I_{OUT}=350\text{mA}, I_{IN}=500\mu\text{A}$ $I_{OUT}=200\text{mA}, I_{IN}=350\mu\text{A}$ $I_{OUT}=100\text{mA}, I_{IN}=250\mu\text{A}$		1.3 1.1 0.9	1.6 1.3 1.1	V	2
Input Current (output on)	$I_{IN(ON)}$	$V_{IN}=2.4\text{V}, I_{OUT}=350\text{mA}$		0.4	0.7	mA	3
Input Current (output off)	$I_{IN(OFF)}$	$I_{OUT}=500\mu\text{A}, T_A=85^\circ\text{C}$	50	65		μA	4
Input Voltage (output on)	$V_{IN(ON)}$	$V_{CE}=2.0\text{V}, h_{FE}=800,$ $I_{OUT}=350\text{mA}$ $I_{OUT}=200\text{mA}$			2.6 2.0	V	5
Clamp Diode Reverse Current	I_R	$V_R=50\text{V}, T_A=25^\circ\text{C}$ $V_R=50\text{V}, T_A=85^\circ\text{C}$			50 100	μA	6
Clamp Diode Forward Voltage	V_F	$I_F=350\text{mA}$			2.0	V	7
Input Capacitance	C_{IN}			15		pF	-
Turn-On Delay	t_{ON}	$V_{OUT}=50\text{V}, R_L=125\Omega, C_L=15\text{pF}$		0.1		μS	8
Turn-Off Delay	t_{OFF}	$V_{OUT}=50\text{V}, R_L=125\Omega, C_L=15\text{pF}$		0.2		μS	8

UTC ULN2003 LINEAR INTEGRATED CIRCUIT

TEST CIRCUIT

1. I_{CEX}

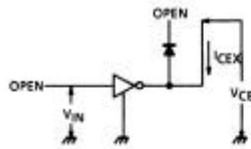

2. $V_{CE(sat)}$, h_{FE}

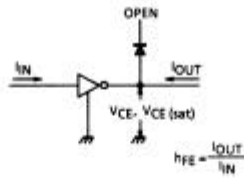

3. $I_{IN(ON)}$

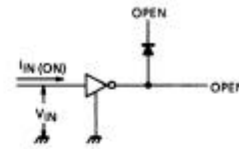

4. $I_{IN(OFF)}$

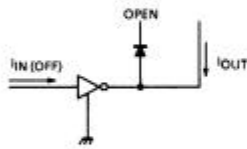

5. $V_{IN(ON)}$

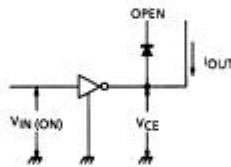

6. I_R

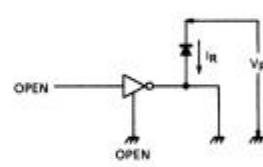

7. V_F

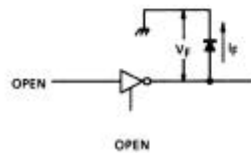

UTC ULN2003 LINEAR INTEGRATED CIRCUIT

8. tON, tOFF

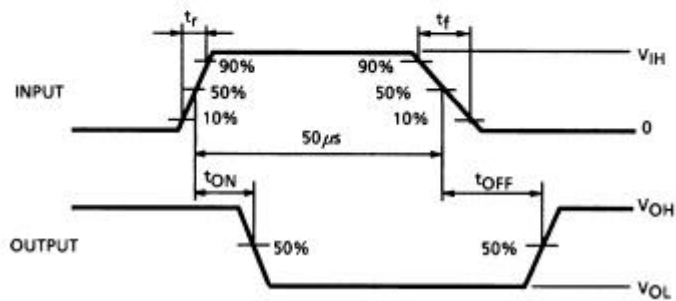
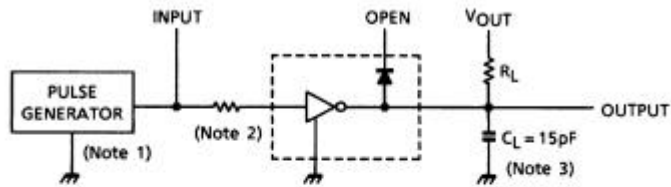

- Note1: Pulse width 50µs, duty cycle 10%
Output impedance 50Ω, $t_r \leq 5\text{ns}$, $t_f \leq 10\text{ns}$
- Note2: $R_1 = 0$, $V_{IH} = 3\text{V}$
- Note3: C_L includes probe and jig capacitance.

UTC ULN2003 LINEAR INTEGRATED CIRCUIT

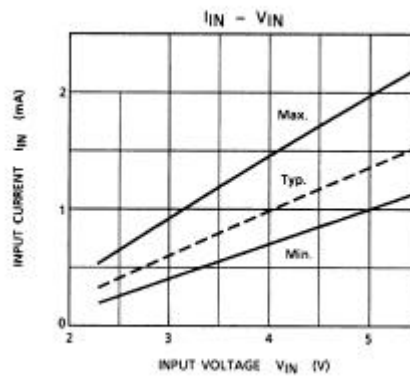
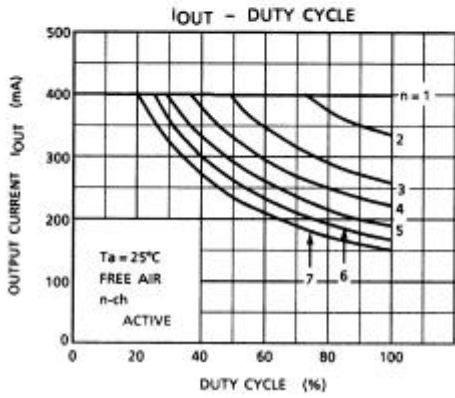
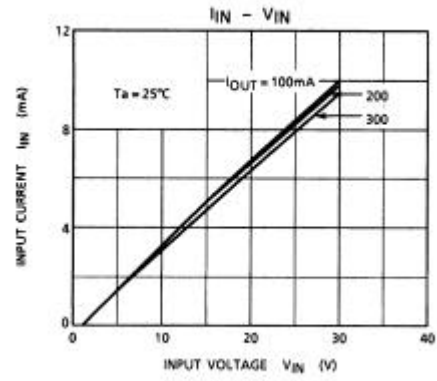
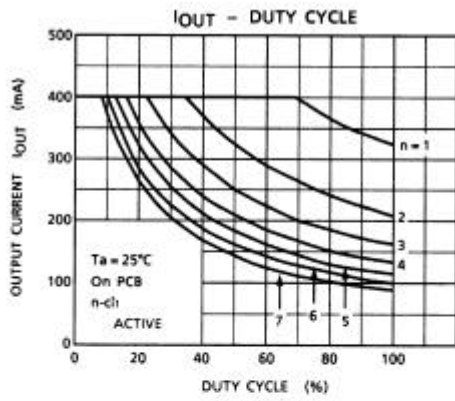

UTC ULN2003 LINEAR INTEGRATED CIRCUIT

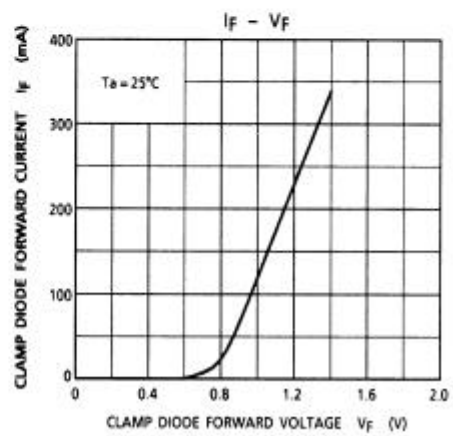
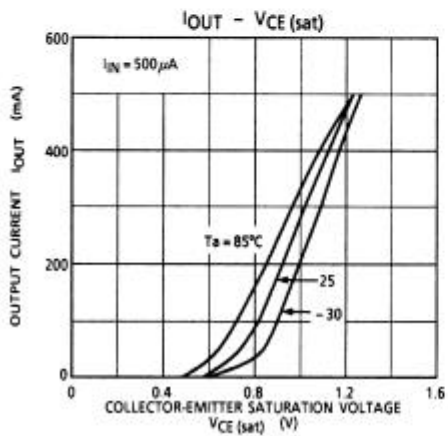
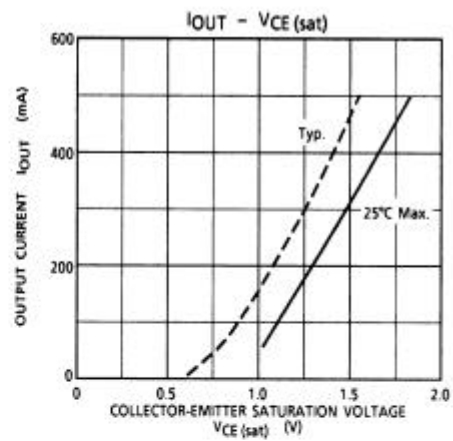
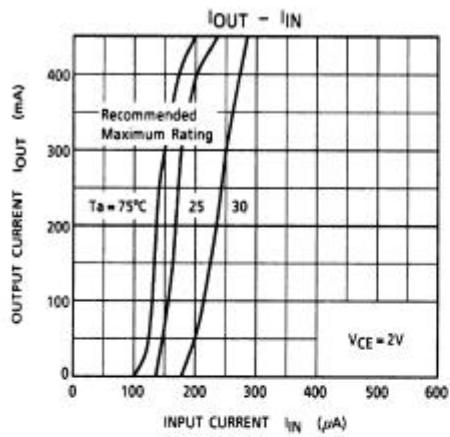

UTC ULN2003 LINEAR INTEGRATED CIRCUIT

