

\* Only for mono  
 # Only for mono bg  
 @ Only for stereo  
 o Only for BG/L

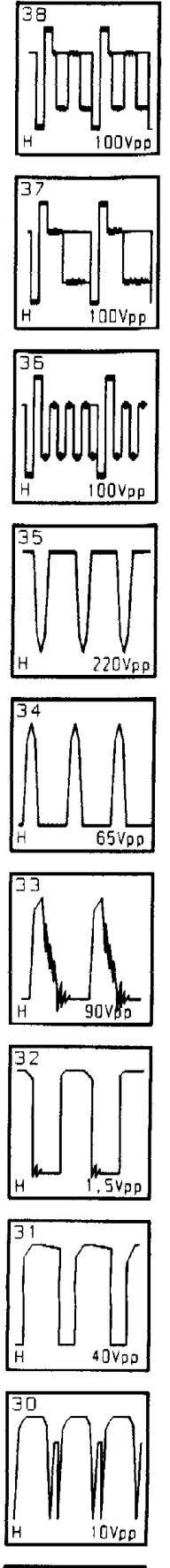

# F-16<sub>R3</sub>

489.04B

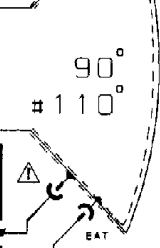
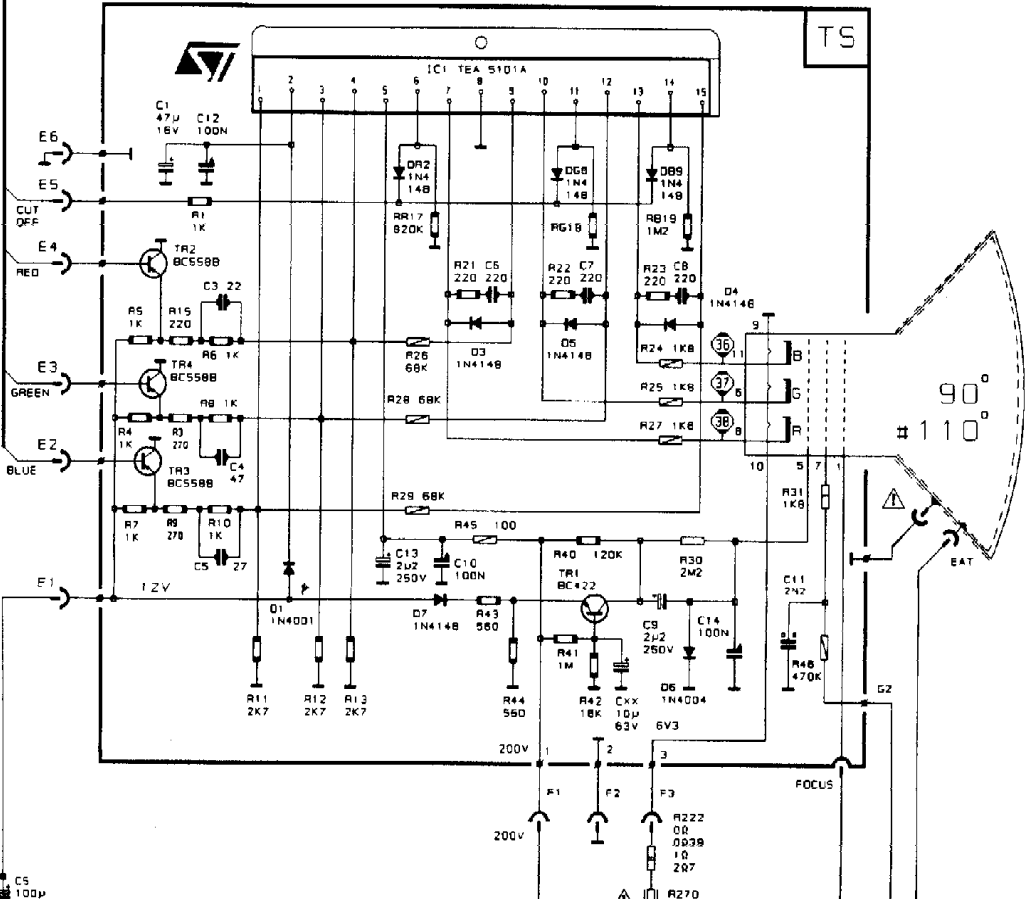
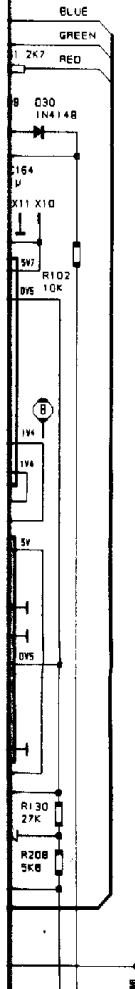

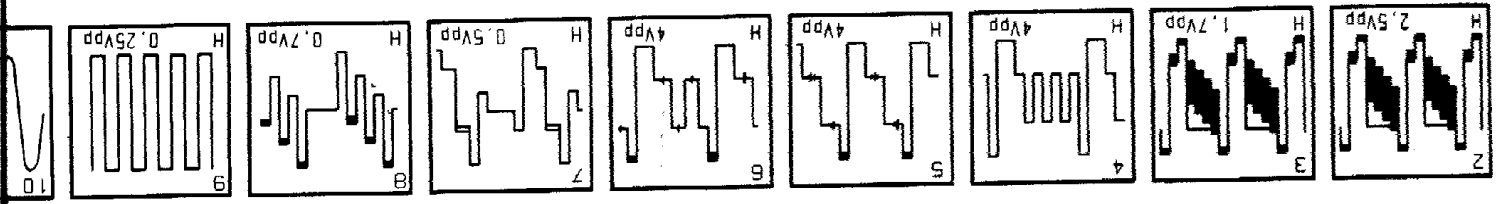
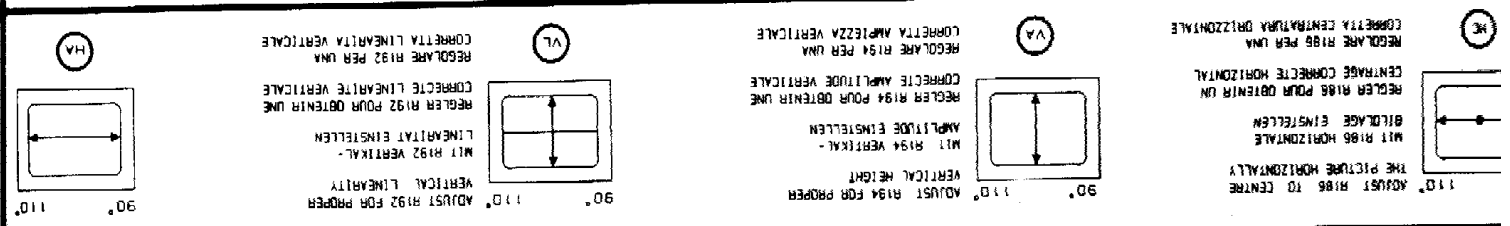

⚠ For safety reasons replace the marked components with original ones only

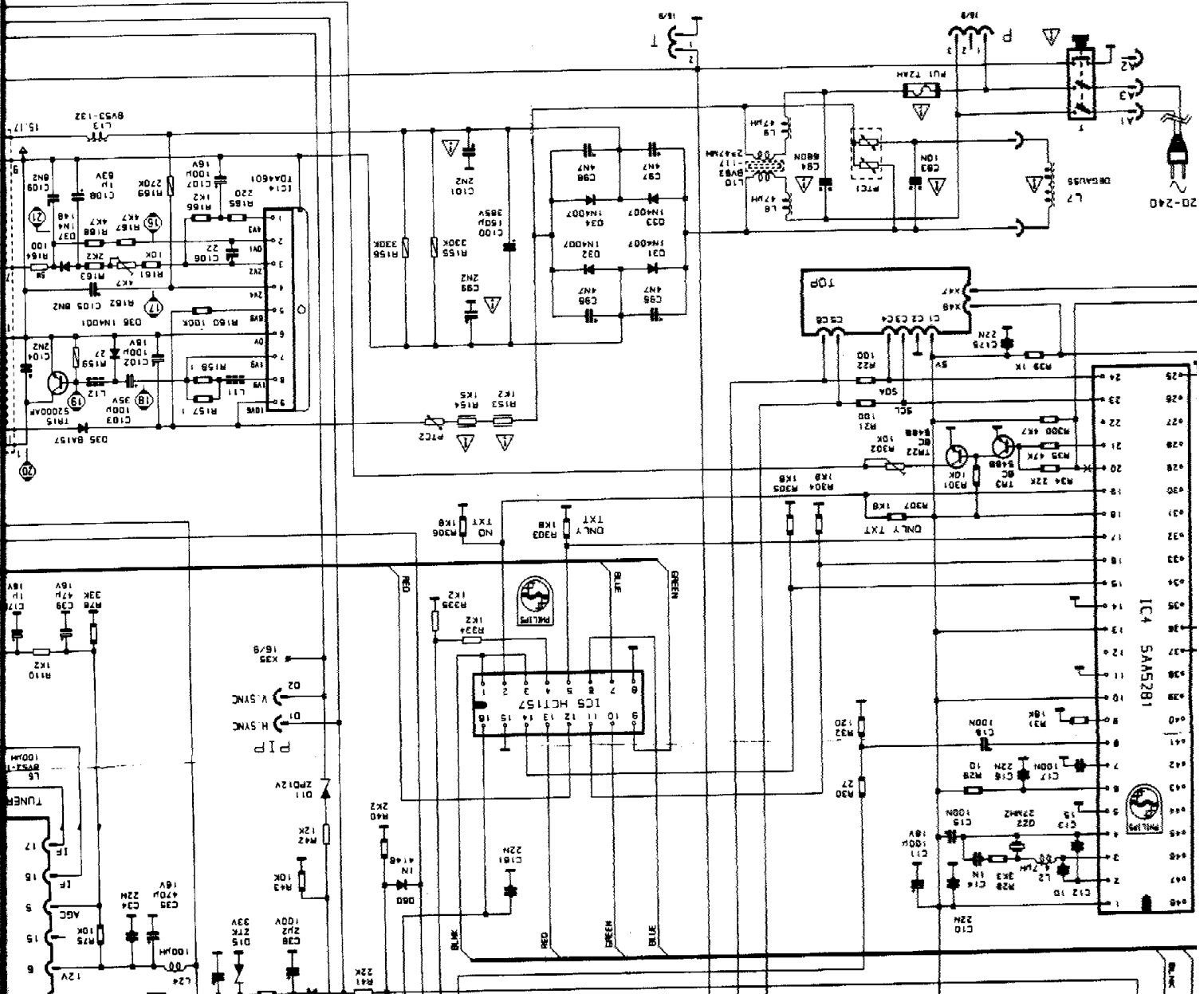

ADJUST L25/R205 FOR PROPER HORIZONTAL WIDTH  
 REGOLA L25/R205 PER UNA CORRETTA AMPIEZZA ORIZZONTALE  
 AMPLITUDE EINSTELLEN  
 CORRECTE AMPLITUDE HORIZONTALE  
 REGLER R205 FÜR HORIZONTALE BREITEN  
 JUSTIER LE TRAFÉZ  
 MIT R205 TRAFÉZ-EINSTELLUNG  
 EINSTELLEN  
 REGLER R205 FÜR HORIZONTALE BREITEN  
 JUSTIER LE TRAFÉZ  
 CORRETTA AMPIEZZA ORIZZONTALE  
 REGOLA R205 PER UNA CORRETTA AMPIEZZA ORIZZONTALE

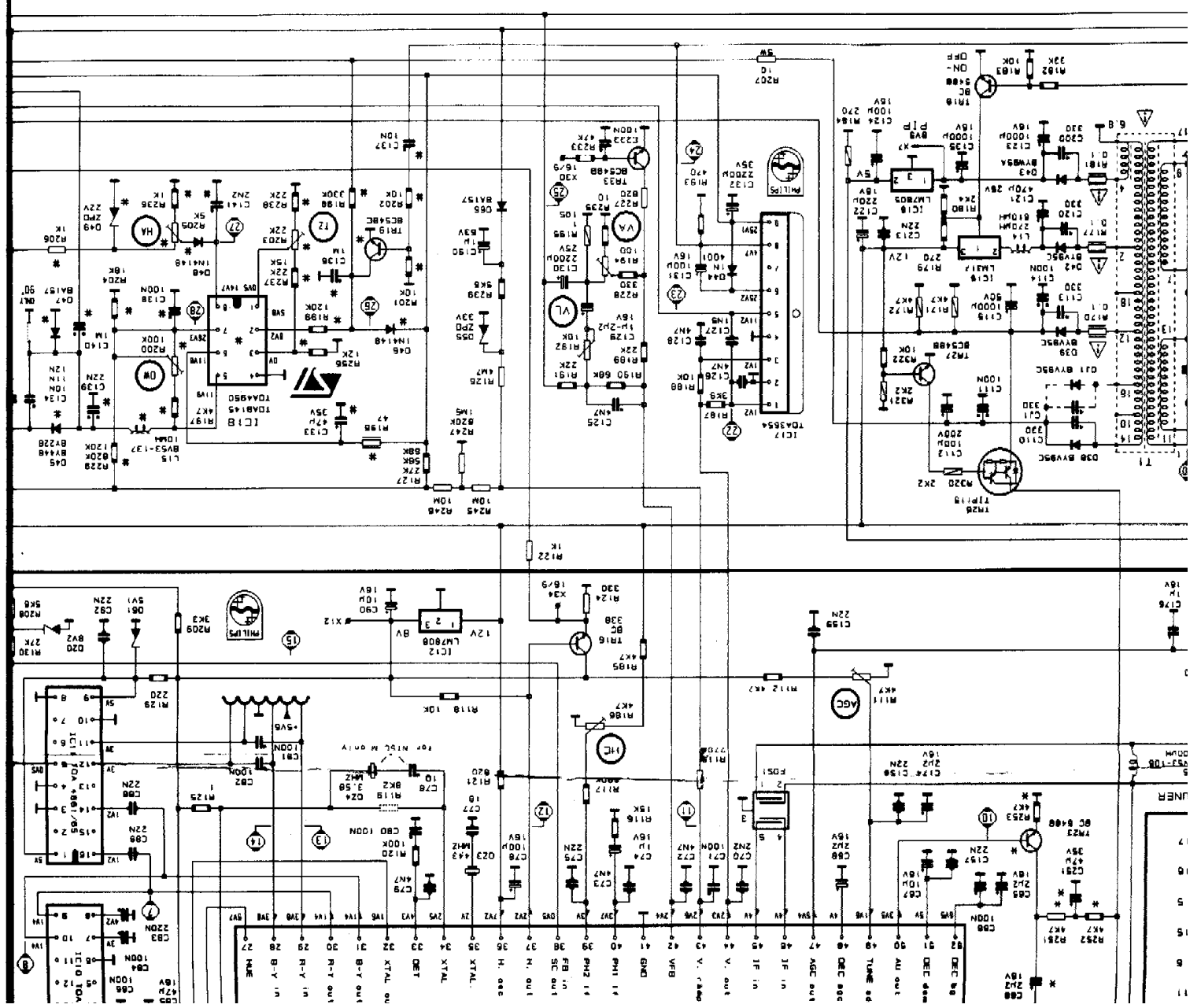
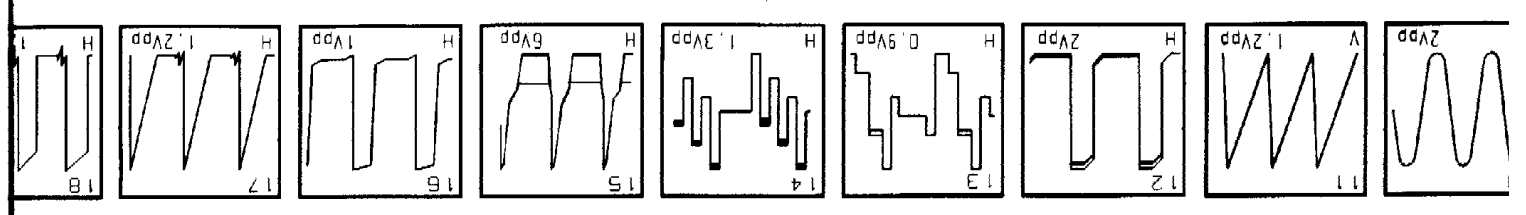

AUTOMATIC GAIN CONTROL  
 AUTOMATISCHE VERSTÄRKUNGSREGELUNG  
 CONTROLLE AUTOMATIQUE DU GAIN  
 FOCUS  
 BILDFOKUS  
 FOCUS  
 SCHIRMGLÜHTENSPIANUNG  
 TENSION DU BRILLE-ECRAN  
 BRIGLIA SCHEMA  
 SCREEN GRID

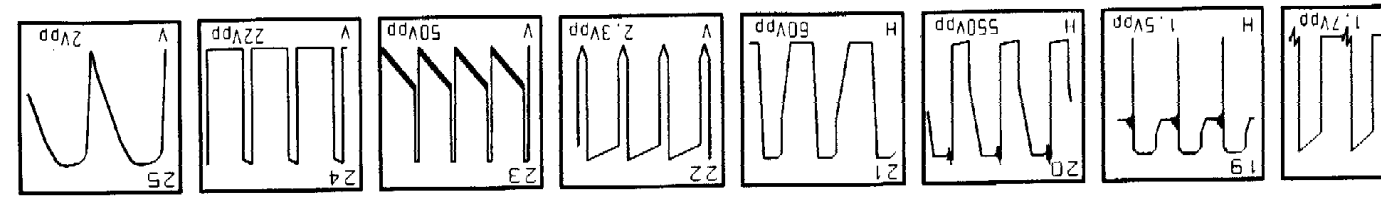

SYMBOLS

	RESISTORS		CAPACITORS
	RESISTORS		CAPACITORS
	MELF		MYLAR CAP
	FUS		DIODE

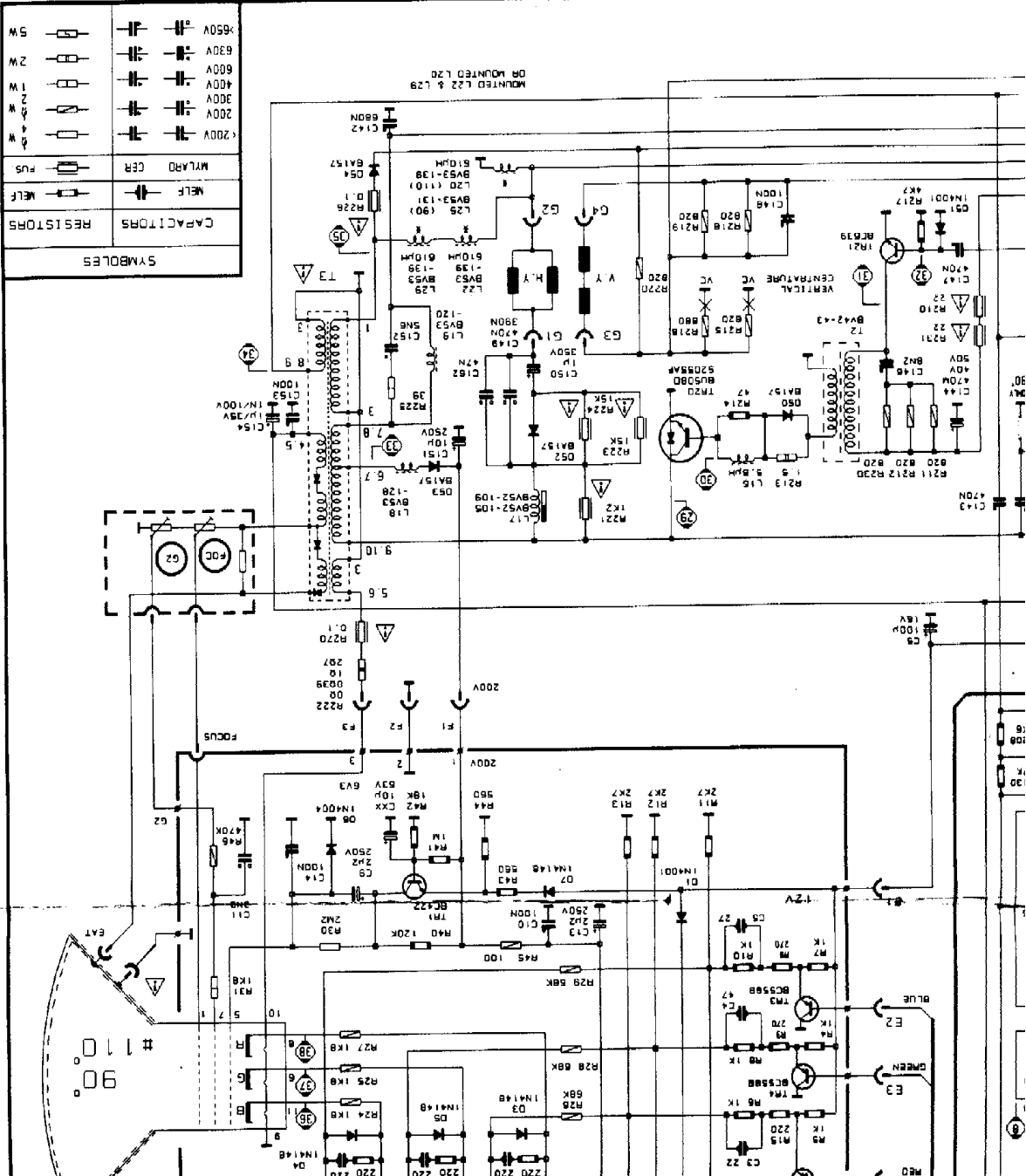
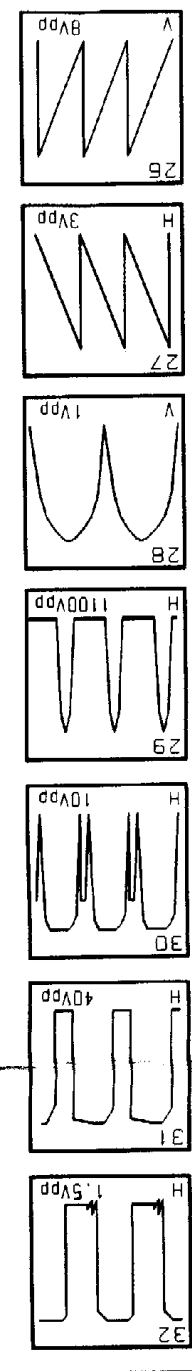

88.65.50.387.00 / OTT.96

