



Website:<http://biz.LGservice.com>  
E-mail:<http://www.LGservice.com/techsup.html>

# COLOR MONITOR

# SERVICE MANUAL

CHASSIS NO. : CA-136

MODEL: **FLATRON<sup>ez</sup>** T710BH (T710BHL-AL\*\*E)  
**FLATRON<sup>ez</sup>** T710SH (T710BHL-AL\*\*M)  
**FLATRON<sup>ez</sup>** T710B (T710BL-AL\*\*E)  
**FLATRON<sup>ez</sup>** T710S (T710BL-AL\*\*M)

CAUTION  
BEFORE SERVICING THE UNIT,  
READ THE SAFETY PRECAUTIONS IN THIS MANUAL.



# CONTENTS

SPECIFICATIONS .....	2	DESCRIPTION OF BLOCK DIAGRAM.....	11
SAFETY PRECAUTIONS .....	3	ADJUSTMENT .....	12
SERVICE PRECAUTION.....	4	TROUBLESHOOTING GUIDE .....	13
TIMING CHART .....	7	EXPLODED VIEW.....	34
WIRING DIAGRAM .....	8	REPLACEMENT PARTS LIST .....	36
DISASSEMBLY .....	9	SCHEMATIC DIAGRAM.....	42
BLOCK DIAGRAM .....	10	PRINTED CIRCUIT BOARD.....	44

## SPECIFICATIONS

### 1. PICTURE TUBE

- Size : 17 inch
- Deflection Angle : 90j
- Neck Diameter : 29.1 mm
- Stripe Pitch : 0.25 mm
- Face Treatment : W-ARASC (Anti-Reflection and Anti-Static Coating)
- Internal : Anti-Glare

### 2. SIGNAL

#### 2-1. Horizontal & Vertical Sync

- 1) Input Voltage Level : Low=0~1.2V, High=2.5~5.5V
- 2) Sync Polarity : Positive or Negative

#### 2-2. Video Input Signal

- 1) Voltage Level : 0 ~ 0.7 Vp-p
  - a) Color 0, 0 : 0 Vp-p
  - b) Color 7, 0 : 0.467 Vp-p
  - c) Color 15, 0 : 0.7 Vp-p
- 2) Input Impedance : 75
- 3) Video Color : R, G, B Analog
- 4) Signal Format : Refer to the Timing Chart

#### 2-3. Signal Connector

3 row 15-pin Connector (Attached)

#### 2-4. Scanning Frequency

- Horizontal : 30 ~ 71 kHz
- Vertical : 50 ~ 160 Hz

### 3. POWER SUPPLY

#### 3-1. Power Range

AC 100-240V~ 50/60Hz, 1.0A

### 3-2. Power Consumption

MODE	POWER CONSUMPTION	LED COLOR
MAX	85 W	GREEN
NORMAL (ON)	73 W	GREEN
STAND-BY	less than 15 W	FLASH
SUSPEND	less than 15 W	FLASH
DPMS OFF	less than 5 W	FLASH

### 4. DISPLAY AREA

#### 4-1. Active Video Area :

- ¥Max Image Size - 325.1 x 243.8 mm (12.80" x 9.60")
- ¥Preset Image Size - 310x 230 mm (12.20" x 9.06")

#### 4-2. Display Color : Full Colors

#### 4-3. Display Resolution : 1280 x 1024 / 60Hz(Max) (Non-Interlace)

#### 4-4. Video Bandwidth : 110 MHz

### 5. ENVIRONMENT

#### 5-1. Operating Temperature: 0jC ~ 40jC (Ambient)

#### 5-2. Relative Humidity : 10%~ 80% (Non-condensing)

#### 5-3. Altitude : 5,000 m

### 6. DIMENSIONS (with TILT/SWIVEL)

- Width : 400 mm (15.75 inch)
- Depth : 411 mm (16.18 inch)
- Height : 401 mm (15.79 inch)

### 7. WEIGHT (with TILT/SWIVEL)

- Net Weight : 15.1 kg (33.96 lbs.)
- Gross Weight : 18.1 kg (39.67 lbs.)

# SAFETY PRECAUTIONS

## SAFETY-RELATED COMPONENT WARNING!

There are special components used in this color monitor which are important for safety. **These parts are marked on the schematic diagram and the replacement parts list.** It is essential that these critical parts should be replaced with the manufacturer's specified parts to prevent X-radiation, shock, fire, or other hazards. Do not modify the original design without obtaining written permission from manufacturer or you will void the original parts and labor guarantee.

**CAUTION:** No modification of any circuit should be attempted.

Service work should be performed only after you are thoroughly familiar with all of the following safety checks and servicing guidelines.

## SAFETY CHECK

Care should be taken while servicing this color monitor because of the high voltage used in the deflection circuits. These voltages are exposed in such areas as the associated flyback and yoke circuits.

## FIRE & SHOCK HAZARD

An isolation transformer must be inserted between the color monitor and AC power line before servicing the chassis.

- In servicing, attention must be paid to the original lead dress specially in the high voltage circuit. If a short circuit is found, replace all parts which have been overheated as a result of the short circuit.
- All the protective devices must be reinstalled per the original design.
- Soldering must be inspected for the cold solder joints, frayed leads, damaged insulation, solder splashes, or the sharp points. Be sure to remove all foreign materials.

## IMPLOSION PROTECTION

All used display tubes are equipped with an integral implosion protection system, but care should be taken to avoid damage and scratching during installation. Use only same type display tubes.

## X-RADIATION

The only potential source of X-radiation is the picture tube. However, when the high voltage circuitry is operating properly there is no possibility of an X-radiation problem. The basic precaution which must be exercised is keep the high voltage at the factory recommended level; the normal high voltage is about 25.8kV. The following steps describe how to measure the high voltage and how to prevent X-radiation.

**Note :** It is important to use an accurate high voltage meter calibrated periodically.

- To measure the high voltage, use a high impedance high voltage meter, connect (-) to chassis and (+) to the CDT anode cap.
- Set the brightness control to maximum point at full white pattern.
- Measure the high voltage. The high voltage meter should be indicated at the factory recommended level.
- If the meter indication exceeds the maximum level, immediate service is required to prevent the possibility of premature component failure.
- To prevent X-radiation possibility, it is essential to use the specified picture tube.

## CAUTION:

Please use only a plastic screwdriver to protect yourself from shock hazard during service operation.

## Leakage Current Hot Check Circuit

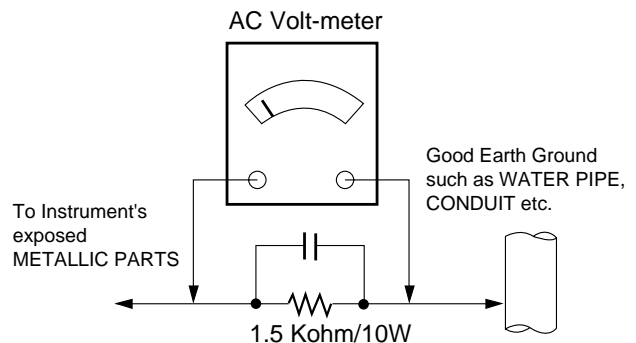

# SERVICING PRECAUTIONS

**CAUTION:** Before servicing receivers covered by this service manual and its supplements and addenda, read and follow the **SAFETY PRECAUTIONS** on page 3 of this publication.

**NOTE:** If unforeseen circumstances create conflict between the following servicing precautions and any of the safety precautions on page 3 of this publication, always follow the safety precautions. Remember: Safety First.

## General Servicing Precautions

1. Always unplug the receiver AC power cord from the AC power source before;
  - a. Removing or reinstalling any component, circuit board module or any other receiver assembly.
  - b. Disconnecting or reconnecting any receiver electrical plug or other electrical connection.
  - c. Connecting a test substitute in parallel with an electrolytic capacitor in the receiver.  
**CAUTION:** A wrong part substitution or incorrect polarity installation of electrolytic capacitors may result in an explosion hazard.
  - d. Discharging the picture tube anode.
2. Test high voltage only by measuring it with an appropriate high voltage meter or other voltage measuring device (DVM, FETVOM, etc) equipped with a suitable high voltage probe.  
Do not test high voltage by "drawing an arc".
3. Discharge the picture tube anode only by (a) first connecting one end of an insulated clip lead to the degaussing or kine aquadag grounding system shield at the point where the picture tube socket ground lead is connected, and then (b) touch the other end of the insulated clip lead to the picture tube anode button, using an insulating handle to avoid personal contact with high voltage.
4. Do not spray chemicals on or near this receiver or any of its assemblies.
5. Unless specified otherwise in this service manual, clean electrical contacts only by applying the following mixture to the contacts with a pipe cleaner, cotton-tipped stick or comparable non-abrasive applicator; 10% (by volume) Acetone and 90% (by volume) isopropyl alcohol (90%-99% strength)  
**CAUTION:** This is a flammable mixture.  
Unless specified otherwise in this service manual, lubrication of contacts is not required.
6. Do not defeat any plug/socket B+ voltage interlocks with which receivers covered by this service manual might be equipped.
7. Do not apply AC power to this instrument and/or any of its electrical assemblies unless all solid-state device heat sinks are correctly installed.
8. Always connect the test receiver ground lead to the receiver chassis ground before connecting the test receiver positive lead.  
Always remove the test receiver ground lead last.

9. Use with this receiver only the test fixtures specified in this service manual.

**CAUTION:** Do not connect the test fixture ground strap to any heat sink in this receiver.

## Electrostatically Sensitive (ES) Devices

Some semiconductor (solid-state) devices can be damaged easily by static electricity. Such components commonly are called *Electrostatically Sensitive (ES) Devices*. Examples of typical ES devices are integrated circuits and some field-effect transistors and semiconductor "chip" components. The following techniques should be used to help reduce the incidence of component damage caused by static by static electricity.

1. Immediately before handling any semiconductor component or semiconductor-equipped assembly, drain off any electrostatic charge on your body by touching a known earth ground. Alternatively, obtain and wear a commercially available discharging wrist strap device, which should be removed to prevent potential shock reasons prior to applying power to the unit under test.
2. After removing an electrical assembly equipped with ES devices, place the assembly on a conductive surface such as aluminum foil, to prevent electrostatic charge buildup or exposure of the assembly.
3. Use only a grounded-tip soldering iron to solder or unsolder ES devices.
4. Use only an anti-static type solder removal device. Some solder removal devices not classified as "anti-static" can generate electrical charges sufficient to damage ES devices.
5. Do not use freon-propelled chemicals. These can generate electrical charges sufficient to damage ES devices.
6. Do not remove a replacement ES device from its protective package until immediately before you are ready to install it. (Most replacement ES devices are packaged with leads electrically shorted together by conductive foam, aluminum foil or comparable conductive material).
7. Immediately before removing the protective material from the leads of a replacement ES device, touch the protective material to the chassis or circuit assembly into which the device will be installed.  
**CAUTION:** Be sure no power is applied to the chassis or circuit, and observe all other safety precautions.
8. Minimize bodily motions when handling unpackaged replacement ES devices. (Otherwise harmless motion such as the brushing together of your clothes fabric or the lifting of your foot from a carpeted floor can generate static electricity sufficient to damage an ES device.)

### **General Soldering Guidelines**

1. Use a grounded-tip, low-wattage soldering iron and appropriate tip size and shape that will maintain tip temperature within the range of 500°F to 600°F.
2. Use an appropriate gauge of RMA resin-core solder composed of 60 parts tin/40 parts lead.
3. Keep the soldering iron tip clean and well tinned.
4. Thoroughly clean the surfaces to be soldered. Use a small wire-bristle (0.5 inch, or 1.25cm) brush with a metal handle.

Do not use freon-propelled spray-on cleaners.

5. Use the following unsoldering technique
  - a. Allow the soldering iron tip to reach normal temperature.  
(500°F to 600°F)
  - b. Heat the component lead until the solder melts.
  - c. Quickly draw the melted solder with an anti-static, suction-type solder removal device or with solder braid.
6. Use the following soldering technique.
  - a. Allow the soldering iron tip to reach a normal temperature (500°F to 600°F)
  - b. First, hold the soldering iron tip and solder the strand against the component lead until the solder melts.

- c. Quickly move the soldering iron tip to the junction of the component lead and the printed circuit foil, and hold it there only until the solder flows onto and around both the component lead and the foil.

**CAUTION:** Work quickly to avoid overheating the circuit board printed foil.

- d. Closely inspect the solder area and remove any excess or splashed solder with a small wire-bristle brush.

### **IC Remove/Replacement**

Some chassis circuit boards have slotted holes (oblong) through which the IC leads are inserted and then bent flat against the circuit foil. When holes are the slotted type, the following technique should be used to remove and replace the IC. When working with boards using the familiar round hole, use the standard technique as outlined in paragraphs 5 and 6 above.

#### **Removal**

1. Desolder and straighten each IC lead in one operation by gently prying up on the lead with the soldering iron tip as the solder melts.
2. Draw away the melted solder with an anti-static suction-type solder removal device (or with solder braid) before removing the IC.

### **Replacement**

1. Carefully insert the replacement IC in the circuit board.
2. Carefully bend each IC lead against the circuit foil pad and solder it.
3. Clean the soldered areas with a small wire-bristle brush. (It is not necessary to reapply acrylic coating to the areas).

### **"Small-Signal" Discrete Transistor**

#### **Removal/Replacement**

1. Remove the defective transistor by clipping its leads as close as possible to the component body.
2. Bend into a "U" shape the end of each of three leads remaining on the circuit board.
3. Bend into a "U" shape the replacement transistor leads.
4. Connect the replacement transistor leads to the corresponding leads extending from the circuit board and crimp the "U" with long nose pliers to insure metal to metal contact then solder each connection.

### **Power Output, Transistor Device**

#### **Removal/Replacement**

1. Heat and remove all solder from around the transistor leads.
2. Remove the heat sink mounting screw (if so equipped).
3. Carefully remove the transistor from the heat sink of the circuit board.
4. Insert new transistor in the circuit board.
5. Solder each transistor lead, and clip off excess lead.
6. Replace heat sink.

### **Diode Removal/Replacement**

1. Remove defective diode by clipping its leads as close as possible to diode body.
2. Bend the two remaining leads perpendicular y to the circuit board.
3. Observing diode polarity, wrap each lead of the new diode around the corresponding lead on the circuit board.
4. Securely crimp each connection and solder it.
5. Inspect (on the circuit board copper side) the solder joints of the two "original" leads. If they are not shiny, reheat them and if necessary, apply additional solder.

### **Fuse and Conventional Resistor**

#### **Removal/Replacement**

1. Clip each fuse or resistor lead at top of the circuit board hollow stake.
2. Securely crimp the leads of replacement component around notch at stake top.
3. Solder the connections.

**CAUTION:** Maintain original spacing between the replaced component and adjacent components and the circuit board to prevent excessive component temperatures.

### **Circuit Board Foil Repair**

Excessive heat applied to the copper foil of any printed circuit board will weaken the adhesive that bonds the foil to the circuit board causing the foil to separate from or "lift-off" the board. The following guidelines and procedures should be followed whenever this condition is encountered.

#### ***At IC Connections***

To repair a defective copper pattern at IC connections use the following procedure to install a jumper wire on the copper pattern side of the circuit board. (Use this technique only on IC connections).

1. Carefully remove the damaged copper pattern with a sharp knife. (Remove only as much copper as absolutely necessary).
2. Carefully scratch away the solder resist and acrylic coating (if used) from the end of the remaining copper pattern.
3. Bend a small "U" in one end of a small gauge jumper wire and carefully crimp it around the IC pin. Solder the IC connection.
4. Route the jumper wire along the path of the out-away copper pattern and let it overlap the previously scraped end of the good copper pattern. Solder the overlapped area and clip off any excess jumper wire.

#### ***At Other Connections***

Use the following technique to repair the defective copper pattern at connections other than IC Pins. This technique involves the installation of a jumper wire on the component side of the circuit board.

1. Remove the defective copper pattern with a sharp knife.  
Remove at least 1/4 inch of copper, to ensure that a hazardous condition will not exist if the jumper wire opens.
2. Trace along the copper pattern from both sides of the pattern break and locate the nearest component that is directly connected to the affected copper pattern.
3. Connect insulated 20-gauge jumper wire from the lead of the nearest component on one side of the pattern break to the lead of the nearest component on the other side.

Carefully crimp and solder the connections.

**CAUTION:** Be sure the insulated jumper wire is dressed so the it does not touch components or sharp edges.

## TIMING CHART

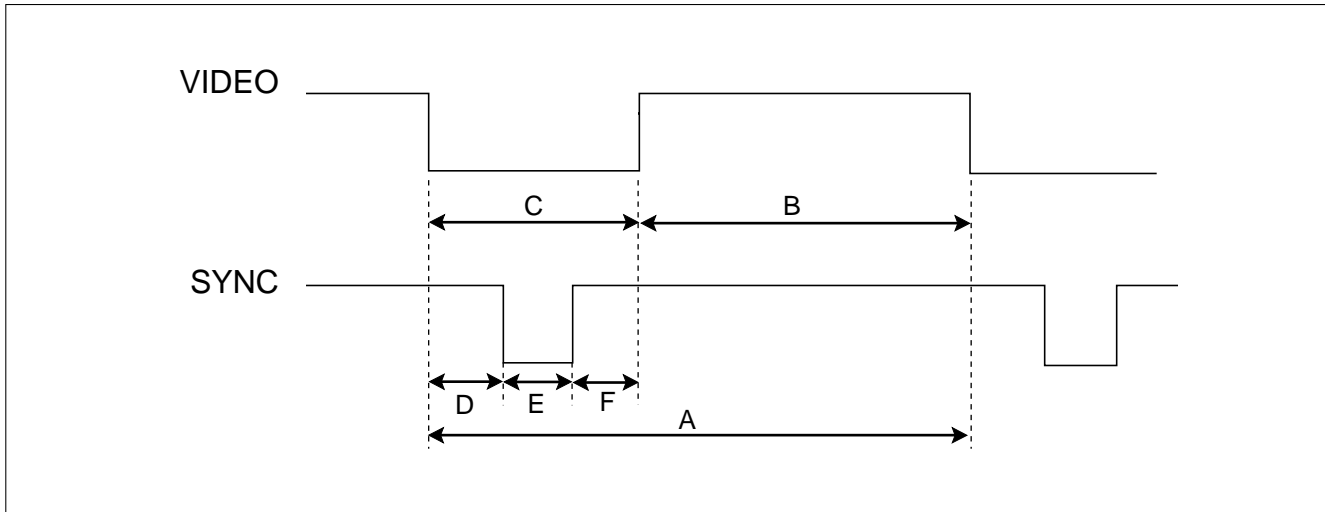

<< Dot Clock (MHz), Horizontal Frequency (kHz), Vertical Frequency (Hz), Horizontal etc... (μs), Vertical etc... (ms) >>

Mode	H/V Sort	Sync Polarity	Frequency	Total Period (A)	Video Active Time (B)	Blanking Time (C)	Sync Duration (E)	Back Porch (F)	Front Porch (D)	Resolution
1	H	-	37.50	26.67	20.32	6.35	2.03	3.81	0.51	640x480
	V	-	74.99	13.335	12.802	0.533	0.080	0.427	0.026	75Hz
2	H	+	46.88	21.33	16.16	5.17	1.62	3.23	0.32	800x600
	V	+	75.01	13.331	12.798	0.533	0.064	0.448	0.021	75Hz
3	H	+	53.68	18.63	14.22	4.41	1.14	2.70	0.57	800x600
	V	+	85.07	11.755	11.178	0.577	0.056	0.503	0.018	85Hz
4	H	+	68.677	14.561	10.836	3.725	1.016	2.201	0.508	1024x768
	V	+	85.00	11.764	11.182	0.582	0.044	0.524	0.014	85Hz

\* No Composite Mode.

# DISASSEMBLY

## 1. TILT/SWIVEL & BACK COVER REMOVAL

- 1) Set the monitor face downward.
- 2) Carefully remove the Tilt/Swivel by pulling it upward.
- 3) Pressing the latch (b), Back cover by pushing it upward.
- 4) Release the latch (c). (See Tip Spec.)
- 5) Slide the Back Cover away from the Front Cabinet of the monitor.

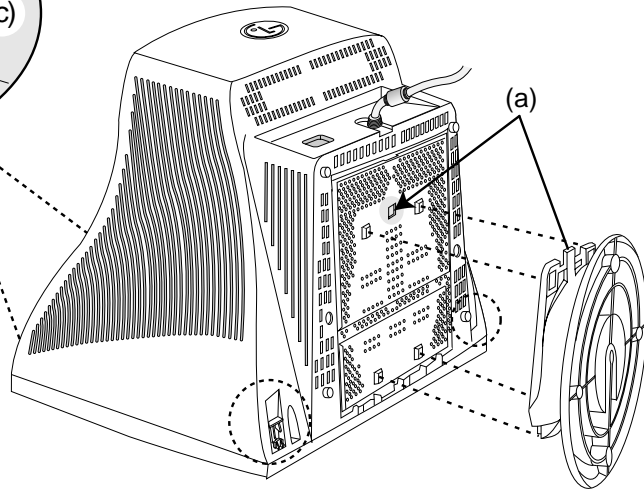
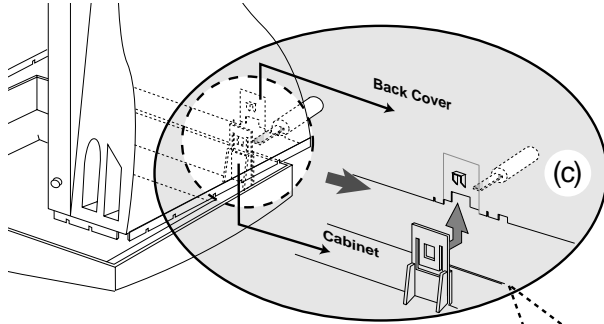

### Tip Spec.

A(Width) : 5.0~15.0mm

B(Depth) : 0.6~0.9mm

C(Height) : 12.0mm

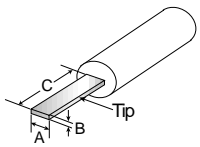



# WIRING DIAGRAM

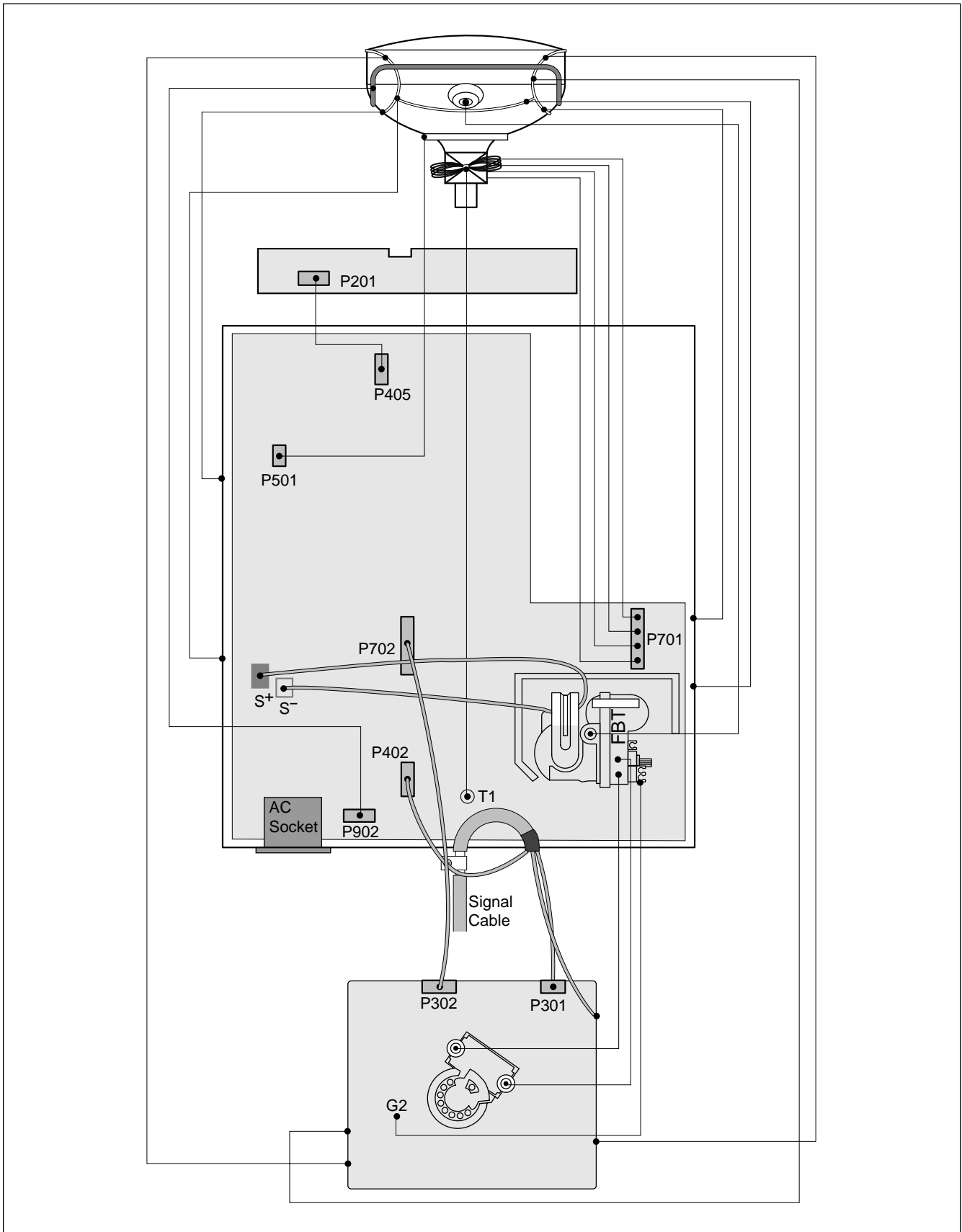

# BLOCK DIAGRAM

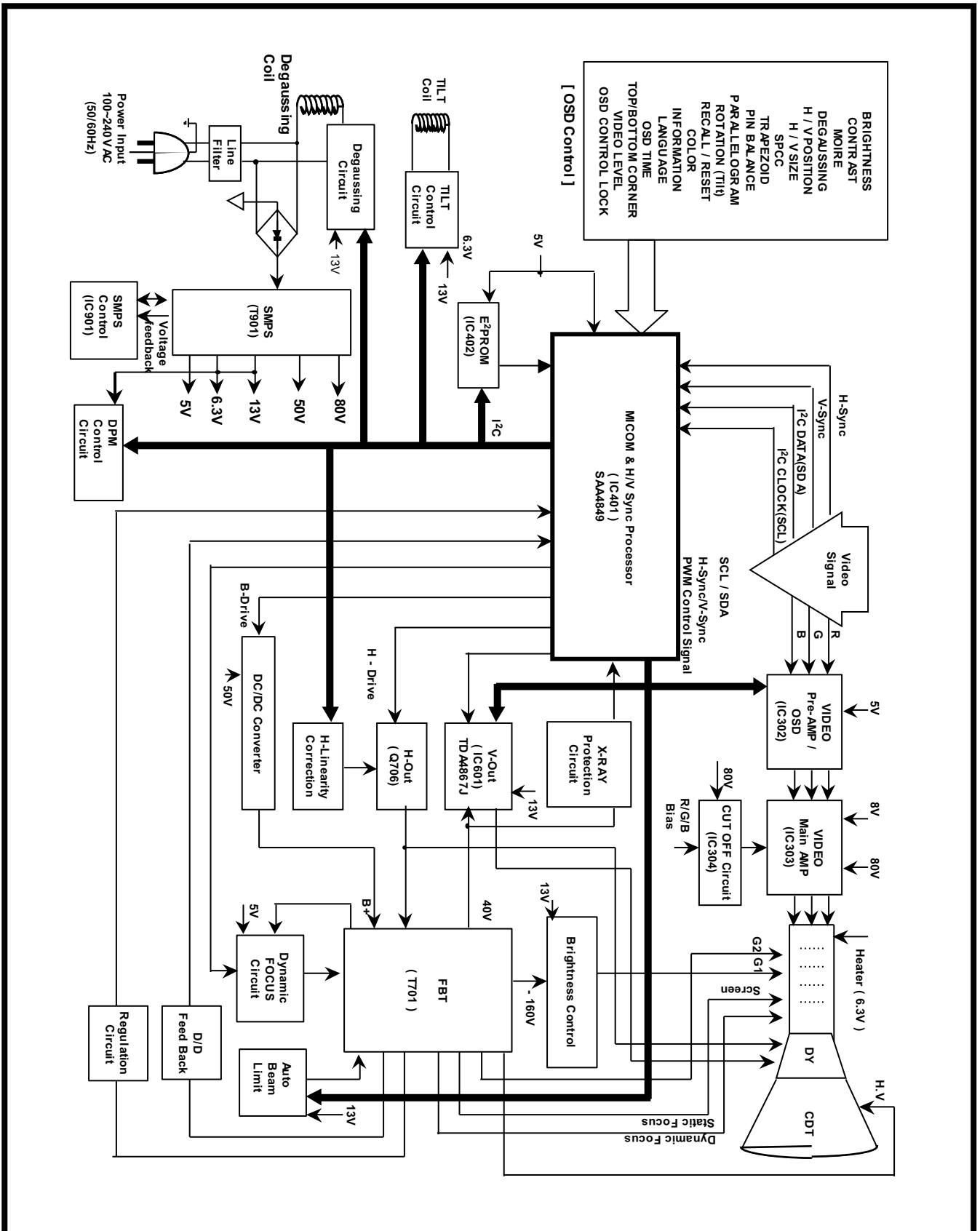

# DESCRIPTION OF BLOCK DIAGRAM

## 1. SMPS(Switching Mode Power Supply)

When you turn on the power switch, the operating procedure is as follows:

- 1) The AC line voltage is rectified by the bridge diode D900.
- 2) The control IC(IC901) starts switching and generates switch pulse in the primary turn of the SMPS transformer(T901)
- 3) The switching pulses of the primary turns are induced to the secondary turns of the transformer by the turn ratio. This pulses are rectified by each diode(D971, D961(D962),D951,D942,D941)
- 4) Each rectified DC voltage(80V, 50V, 13V, 6.3V and 5V)

## 2. Over Voltage Protection Circuit

When the input of IC901 Vin (pin 4) is more than 22V, all the secondary voltages of the SMPS transformer (T901) down to low value

## 3. Display Power Management Circuit(DPM)

- 1) STAND-BY & SUSPEND Mode  
When no input of horizontal or vertical sync Q951, Q941 are turned off and Q952,Q942 are turned off. Then input power consumption is below 5 watts.
- 2) OFF Mode  
When no input of horizontal and vertical sync Q951, Q941 are turned off and Q952, Q942 are turned off. Then input power consumption is below 5 watts.

## 4. Microprocessor Control & Horizontal and Vertical Sync Processor Circuit

The operating procedure is as follows ;

- 1) There is Horizontal & Vertical process function in Microprocessor.(IC401)
- 2) Microprocessor (IC401) discriminates the operating mode from the sync polarity and resolution.
- 3) After microprocessor reads these adjusted mode data stored at EEPROM, it controls operating mode data through IIC
- 4) Users can control screen condition by the OSD Select,Up, Down, Left, Right, Exit.

## 5. D/D Converter Circuit.

To obtain constant high voltage, this circuit supplies controlled DC voltage for FBT and horizontal deflection circuit according to the horizontal sync frequency.

## 6. X-RAY Protection Circuit

When the high Voltage reaches to 29kV in an abnormal case, the high voltage detector circuit, R818,D721,C739-1 R416, C409 start operation to shut down high voltage circuit.

## 7. Horizontal S-correction Circuit.

This circuit corrects the horizontal linearity for each horizontal sync frequency.

## 8. Horizontal drive and Output Circuit.

This circuit is a horizontal deflection amplifier for raster scan.

## 9. ABL Circuit

This circuit limits the beam-current for the reliability of CDT

## 10. Vertical Output Circuit

This circuit takes the vertical ramp wave from the TDA4867J (IC601) and perform the vertical deflection by supplying the saw-tooth wave current to the vertical deflection yoke.

## 11. Blanking and Brightness Control Circuit.

Blanking circuit eliminates the retrace line by supplying a negative pulse wave to the G1 of the CDT. Brightness control circuit is used for control of the screen brightness by changing the DC level G1.

## 12. Image Rotation (Tilt) Circuit.

This circuit corrects the tilt of the screen by supplying the image rotation signal to the tilt coil which is attached near the deflection yoke of the CDT.

## 13. OSD (On Screen Display) Circuit.

This circuit displays information of the monitor's status on the screen.

## 14. Video Processor Circuit.

Video processor circuit consists of the video drive output block. The video drive IC(IC302) receives the video signal from PC. The gain of each channel is controlled by MICOM through IIC.

The cut-off circuit compensate different voltage of each channel between the cathode and the G1 of the CDT.

**15. Video Pre-Amp Circuit.**

This circuit amplifies the analog video signal from 0~0.7 V to 0~4 V. It is operated by taking the clamp, R,G,B drive and contrast signal from the MICOM (IC401)

**16. Video Output Amp Circuit.**

This circuit amplifies the video signal which comes from the video pre-amp circuit and amplified it to applied the CDT cathode

# ADJUSTMENT

## 1. Preparation for Service Adjustment

### GENERAL INFORMATION

All adjustment are thoroughly checked and corrected when the monitor leaves the factory, but sometimes several adjustments may be required. Adjustment should be following procedure and after warming up for a minimum of 30 minutes.

- Alignment appliances and tools.
  - IBM compatible PC.
  - Programmable Signal Generator. (eg. VG-819 made by Astrodesign Co.)
  - EPROM or EEPROM with saved each mode data.
  - Alignment Adaptor and Software.
  - Digital Voltmeter.
  - White Balance Meter.
  - Luminance Meter.
  - High-voltage Meter.

### AUTOMATIC AND MANUAL DEGAUSSING

The degaussing coil is mounted around the CDT so that automatic degaussing when turn on the monitor. But a monitor is moved or faced in a different direction, become poor color purity cause of CDT magnetized, then press DEGAUSSING on the OSD menu.

### ADJUSTMENT PROCEDURE & METHOD

- Install the cable for adjustment such as Figure 1 and run the alignment program on the DOS for IBM compatible PC.
- Set external Brightness and Contrast volume to max position.

#### 1. Adjustment for B<sup>+</sup> Voltage.

- 1) Display cross hatch pattern at Mode 4.
- 2) Check D961 cathode voltage within  $50V \pm 1V$  .

#### 2. Adjustment for High-Voltage.

- 1) Display cross hatch pattern at Mode 4.
- 2) Enter the SVC SUB menu as the following instruction.
- 3) Adjust H/Voltage to  $25.8kV \pm 0.1 kV$  by adjust 1-P value.

## 2. Adjustment by Service Hot key

### How to enter SVC HOT KEY

1. Press Menu and OSD window will appear.
2. While OSD window is displayed, ★★ is seen on the left bottom of OSD window.
3. Press  $\triangleleft$  + power switch simultaneously and the screen will immediately refresh.
4. Press Menu and make sure that ★★ is changed to 1 2.
5. Follow the menu on the left of OSD window to find 12 and OSD will change as shown in the figure.
6. Select Degauss in the above figure and then press Select and  $\triangleright$  to enter the screen of the SUB menu. (Back Raster for Pattern)

### FOS SPEC

1. Size  
 H :  $310 \pm 4mm$   
 V :  $230 \pm 4mm$   
 Scanning frequency : All Mode (Mode 1~4)  
 Display image : Cross hatch pattern
2. Centering  
 Scanning frequency : All Mode (Mode 1~4)  
 Display image : Crosshatch pattern  
 Horizontal : 10 Row  
 Vertical : 8 Row

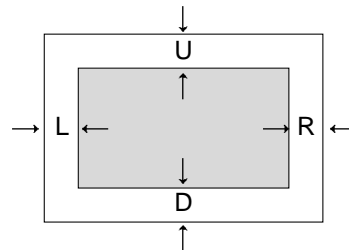

$$H : |L-R| \leq 4mm, V : |U-D| \leq 4mm$$

#### 3. Tilt

- Scanning frequency : All Mode (Mode 1~4)  
 Display image : Crosshatch pattern  
 Horizontal : 10 Row  
 Vertical : 8 Row

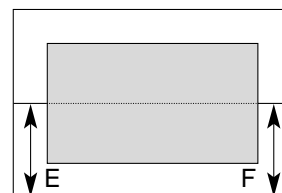

$$\text{Tilt} : |E-F| \leq 2.0mm$$

4. Distortion  
 Scanning frequency : All Mode (Mode 1~4)  
 Display image : Crosshatch pattern  
 Horizontal : 10 Row  
 Vertical : 8 Row

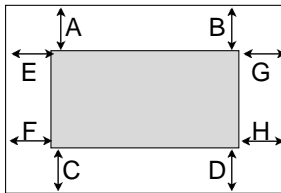

$$\begin{aligned} |A-B| &\leq 2.0\text{mm}, & |C-D| &\leq 2.0\text{mm} \\ |E-F| &\leq 2.0\text{mm}, & |G-H| &\leq 2.0\text{mm} \end{aligned}$$

5. Displa Size drift  
 •  $\pm 4\text{mm}$  : 25°C Standard, 10°C, 35°C  
 •  $\pm 0.5\text{mm}$  : 180V ~ 264V

6. Linearity

				Y1
				Y2
				Y3
				Y4
X1	X2	X3	X4	

Formula :  $\{(Max - Min) / Max\} \times 100(\%)$   
 Criteria : H - 10% Max. (Upper 40kHz)  
 14% Max. (Less 40kHz)  
 V - 8% Max.

7. Regulation  
 Luminance  $\leq 2\text{mm}$   
 Dynamic(Iode)  $\leq 2\text{mm}$   
 Scanning frequency : All Mode (Mode 1~4)

8. Trapezoid

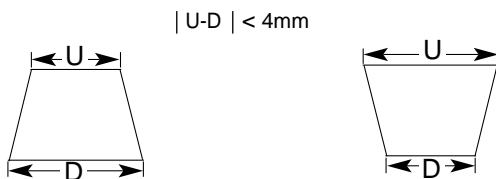

9. Pin Balance

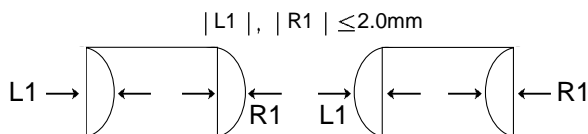

10. Parallelogram

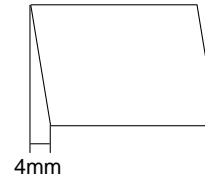

11. Adjustment of white balance (Adjustment of chromaticity diagram)  
 \*(Adjustment of white balance must be made after entering Hot Key Mode and DEGAUSS.)

CONDITIONS

Signal: 69 kHz / 85 Hz  
 Display image: Back raster (Color 0,0)  
 Contrast: Maximum  
 Brightness: Maximum  
 Color temperature: 9300K

11-1. Adjustment of cut off (Adjustment of back raster)

11-1(a). Before adjustment, press Menu and Degauss to remove.  
 => Enter hot key mode.  
 Adjust Brightness and Contrast to Max in OSD window.

- Adjust cut off (back raster) first. Enter DEGAUSS in the Menu and modify the following data.  
 Modify RCUT to Min ,  
 Modify GCUT To Min ,  
 Adjust to BCUT Data = 127 (7F (h)) ,  
 Adjust to SBRT Data = 205 ( CD (h)).
- Turn FBT screen volume on "CRT COLOR ANALYZER CA-100" equipment to adjust Brightness to 0.4  $\pm 0.05\text{FL}$ .
- Adjust RCUT, GCUT, and SBRT to set chromaticity diagram at :  
 x:  $0.283 \pm 0.005$   
 y:  $0.298 \pm 0.005$   
 Y:  $0.40 \pm 0.05\text{FL}$

\* If color values would not be matched desirable values, repeat sequence 1 and 2 after readjusting "GREEN CUTOFF" control a little different.

### 11-2. Adjustment of White Balance

After finishing adjustment of cut off (back raster), approve "Color(15.0) Full white pattern".

Adjust BDRV Data = 90, SCON=127.

Adjust RDRV and GDRV to set chromaticity diagram at :

x:  $0.283 \pm 0.005$

y:  $0.298 \pm 0.005$

Approve "Window pattern (70x70mm)" to adjust

S-CON to Y :  $50 \pm 1FL$ .

Approve "Color (15.0) Full white pattern" again and adjust ABL Data to Y :  $32 \pm 1FL$

### 12. Focus Adjustment

#### CONDITIONS

Scanning frequency : All Mode (Mode 1~4)

Display image:  $\Phi$ Character pattern

Brightness: Cut off point

Contrast: Maximum

#### PROCEDURE

1. Adjust the Focus VR on the FBT to display the sharpest image possible.
2. Use Loctite to seal the Focus VR in position.

### 13. Color Purity Adjustment

Color purity is the absence of undesired color.

Conspicuous mislanding (unexpected color in a uniform field) within the display area shall not be visible at a distance of 50 cm from the CRT surface.

#### CONDITIONS

Orientation: Monitor facing east

Scanning Frequency: 1024 x 768@85Hz(69kHz/85Hz)

Display image: White flat field

Luminance: Cut off point at the center of the display area

Note: Color purity adjustments should only be attempted by qualified personnel.

### PROCEDURE

For trained and experienced service technicians only.

Use the following procedure to correct minor color purity problems:

1. Make sure the display is not affected by external magnetic fields.
2. Very carefully break the glue seal between the 2-pole purity convergence magnets (PCM), the band and the spacer.
3. Make sure the spacing between the PCM assembly and the CRT stem is  $29 \text{ mm} \pm 1 \text{ mm}$ .
4. Display a green pattern over the entire display area.
5. Adjust the purity magnet rings on the PCM assembly to display a pure green pattern.  
(Optimum setting:  $x = 0.295 \pm 0.015$ ,  
 $y = 0.594 \pm 0.015$ )
6. Repeat steps 4 and 5 using a red pattern and then again, using a blue pattern.

Table 4-6. Color Purity Tolerances

Red:	$x=0.620 \pm 0.015$	$y=0.334 \pm 0.015$
Green:	$x=0.620 \pm 0.015$	$y=0.334 \pm 0.015$
Blue:	$x=0.620 \pm 0.015$	$y=0.334 \pm 0.015$

(For 9300K color adjustment:  $x = 0.283 \pm 0.02$ ,  
 $y = 0.298 \pm 0.02$ )

7. When you have the PCMs properly adjusted, carefully glue them together to prevent their movement during shipping.

### 3. Adjustment Using Service software Program (Adjustment Program)

#### 1. Adjustment for Factory Mode (Preset Mode).

- 1) Display cross hatch pattern at Mode All.
- 2) Run alignment program for T710BHL on the IBM compatible PC.
- 3) EEPROM → ALL CLEAR → Y(Yes) command.  
**<Caution>** Do not run this procedure unless the EEPROM is changed. All data in EEPROM (mode data and color data) will be erased.
- 4) COMMAND → PRESET START → Y(Yes) command.
- 5) DIST. ADJ. → FOS. ADJ command.
- 6) Adjust H-POSITION as arrow keys to center of the screen.
- 7) Adjust H-SIZE as arrow keys to  $310 \pm 2\text{mm}$ .
- 8) Adjust V-POSITION as arrow keys to center of the screen.
- 9) Adjust V-SIZE as arrow keys to  $230 \pm 2\text{mm}$ .
- 10) Adjust TRAPEZOID as arrow keys to be the best condition.
- 11) Adjust SIDE PINCUSHON as arrow keys to be the best condition.
- 12) Adjust TILT as arrow keys to be the best condition.
- 13) Display cross hatch pattern at Mode 4.
- 14) DIST. ADJ. → BALANCE DATA command.
- 15) Adjust balance of Pin-Balance as arrow keys to be the best condition.
- 16) Adjust parallelogram as arrow keys to be the best condition.
- 17) Save of the Mode.
- 18) Save of the System.
- 19) Display from Mode 4 and repeat above from number 6) to 16).
- 20) COMMAND → PRESET EXIT → Y (Yes) command.

#### 2. Adjustment for White Balance and Luminance.

- 1) Set the White Balance Meter.
- 2) Press the DEGAUSSING on the OSD menu for demagnetization of the CDT.
- 3) Display color 0,0 pattern at Mode 4.
- 4) COMMAND → PRESET START → Y(Yes) command.
- 5) Set Bightness and Contrast to max position.
- 6) COLOR ADJ. → LUMINANCE command of the alignment program.
- 7) COLOR ADJ. → BIAS ADJ. command of the alignment program.
- 8) Check whether blue color or not at R-BIAS and G-BIAS to min position, Sub-Brightness to 205 (CD(h))position, B-Bias to 127(7F(h))position. If it's not blue color, the monitor must repair.
- 9) Adjust Screen control on the FBT to  $0.4 \pm 0.05\text{FL}$  of the raster luminance.
- 10) Adjust R-BIAS and G-BIAS command to  $x=0.283 \pm 0.006$  and  $y=0.298 \pm 0.006$  on the White Balance Meter with PC arrow keys.
- 11) Display color 15,0 Full White(70x70mm) at mode 4.
- 12) DRIVE ADJ command.
- 13) Set B-DRIVE to 90(5A(h)) at DRIVE of the alignment program.
- 14) Adjust R-DRIVE and G-DRIVE command to white balance  $x=0.283 \pm 0.003$  and  $y=0.298 \pm 0.003$  on the White Balance Meter with PC arrow keys.
- 15) Adjust SUB-CONTRAST command to  $50 \pm 1\text{FL}$  of the raster luminance.
- 15) Display color 15,0 full white patten at Mode 4.
- 16) COLOR ADJ. → LUMINANCE → ABL command.
- 17) Adjust ABL to  $32 \pm 1\text{FL}$  of the luminance.
- 18) Exit from the program.



## 4. EDID Data Edit Using Service software Program

### 4.1 Read and Modify EDID Data

- 1) Connector the monitor and adjust device as Figure 1
- 2) Display color 15,0 cross hatch pattern at Mode 4.
- 3) Use EDIT – MODEL SEL. command to select the right model info file.
- 4) Use EDIT – EDID INFO command and return to read the EDID Data.
- 5) Modify the EDID Data if needed and using F10 to save the change and exit.

### 4.2 Write EDID Data.

- 1) Display color 15,0 cross hatch pattern at Mode 4.
- 2) Use EEPROM – Write EDID command and confirm  
“EDID Write OK!!” message of monitor.
- 3) Exit from the alignment program.
- 4) Power switch OFF/ON for EDID data save.

## EDID DATA EDIT

### T710BHL

	00	01	02	03	04	05	06	07	08	09	0A	0B	0C	0D	0E	0F
00	00	FF	FF	FF	FF	FF	FF	00	1E	6D	66	43	*01	00	00	00
10	**01	0E	01	03	18	21	18	B5	EA	F6	29	A2	53	47	99	25
20	10	48	4C	FF	FE	80	31	59	71	4F	45	59	61	59	81	80
30	81	4A	01	01	01	01	EA	24	00	60	41	00	28	30	30	60
40	13	00	36	E6	10	00	00	1E	00	00	00	FD	00	32	A0	1E
50	47	0B	00	0A	20	20	20	20	20	20	20	20	00	00	00	FC
60	37	31	30	42	48	0A	20	20	20	20	20	20	00	00	00	FC
70	00	0A	20	20	20	20	20	20	20	20	20	20	20	20	00	***

### T710BL

0	1	2	3	4	5	6	7	8	9	A	B	C	D	E	F
00	FF	FF	FF	FF	FF	FF	00	1E	6D	#65	#43	*01	*01	*01	*01
**01	***DE	01	03	18	21	18	B5	EA	F6	29	A2	53	47	99	25
10	48	4C	FF	FE	80	31	59	71	4F	45	59	61	59	81	80
81	4A	01	01	01	01	EA	24	00	60	41	00	28	30	30	60
13	00	36	E6	10	00	00	1E	00	00	00	FD	00	32	A0	1E
47	0B	00	0A	20	20	20	20	20	20	20	20	20	00	00	FC
37	31	30	42	0A	20	20	20	20	20	20	20	20	00	00	FC
00	0A	20	20	20	20	20	20	20	20	20	20	20	20	00	**

Figure 1. Cable Connection

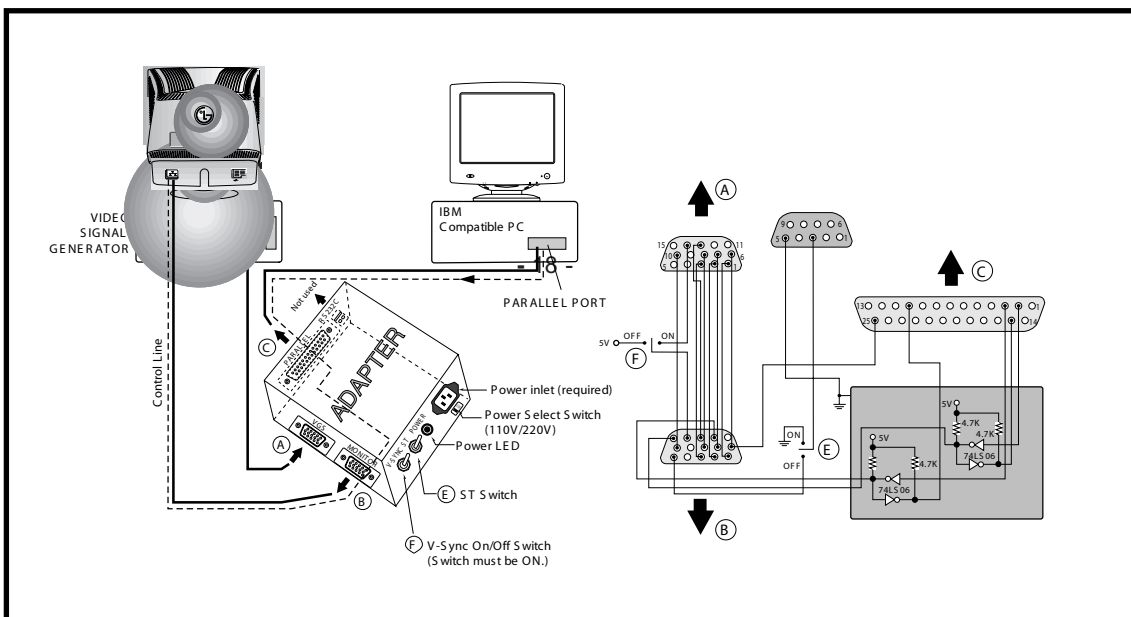

# TROUBLESHOOTING GUIDE

## 1. NO POWER

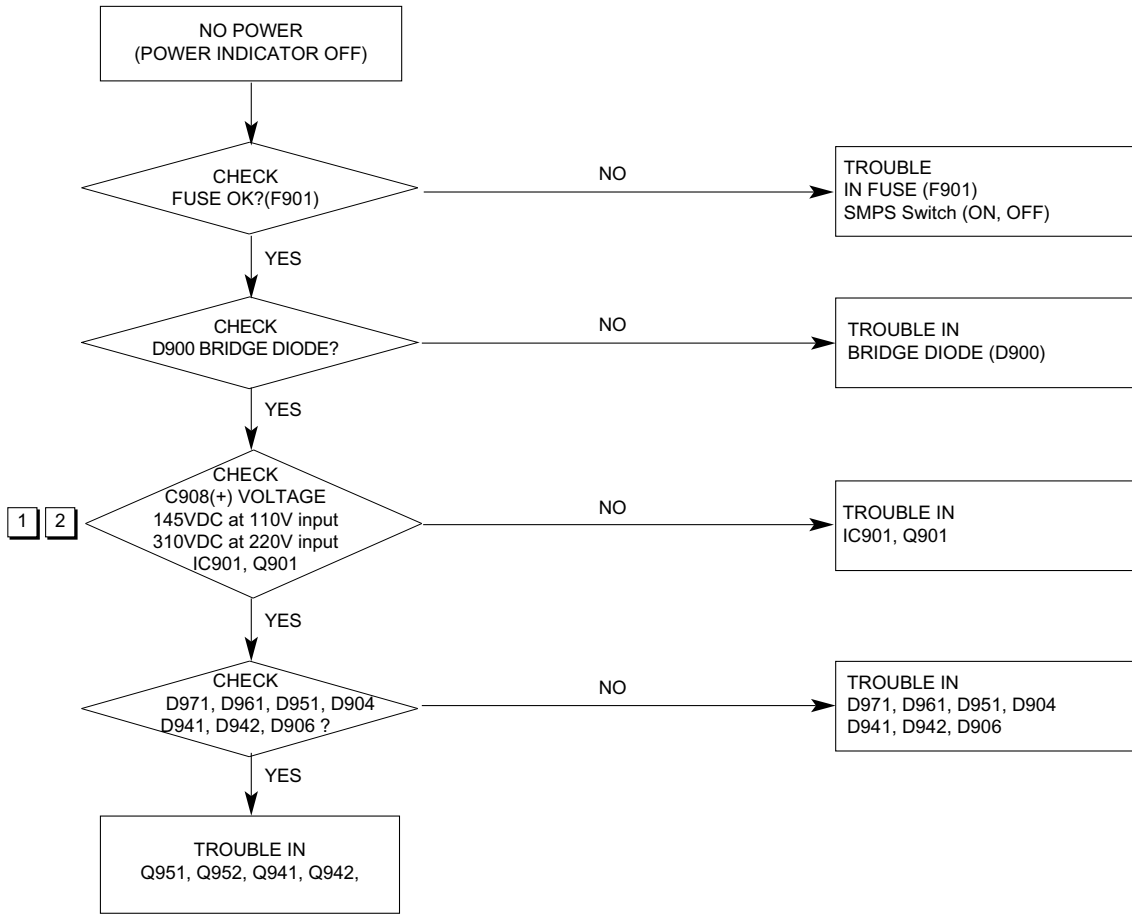

### Waveforms

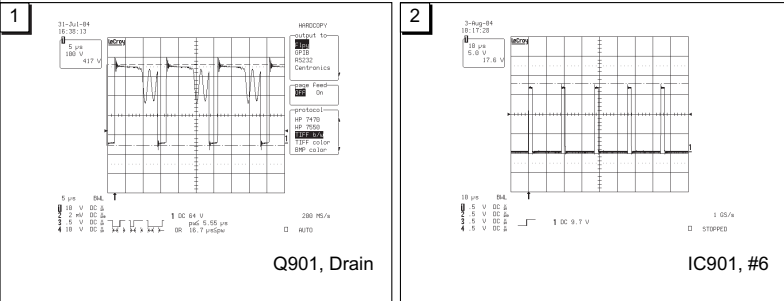

## 2. NO CHARACTER

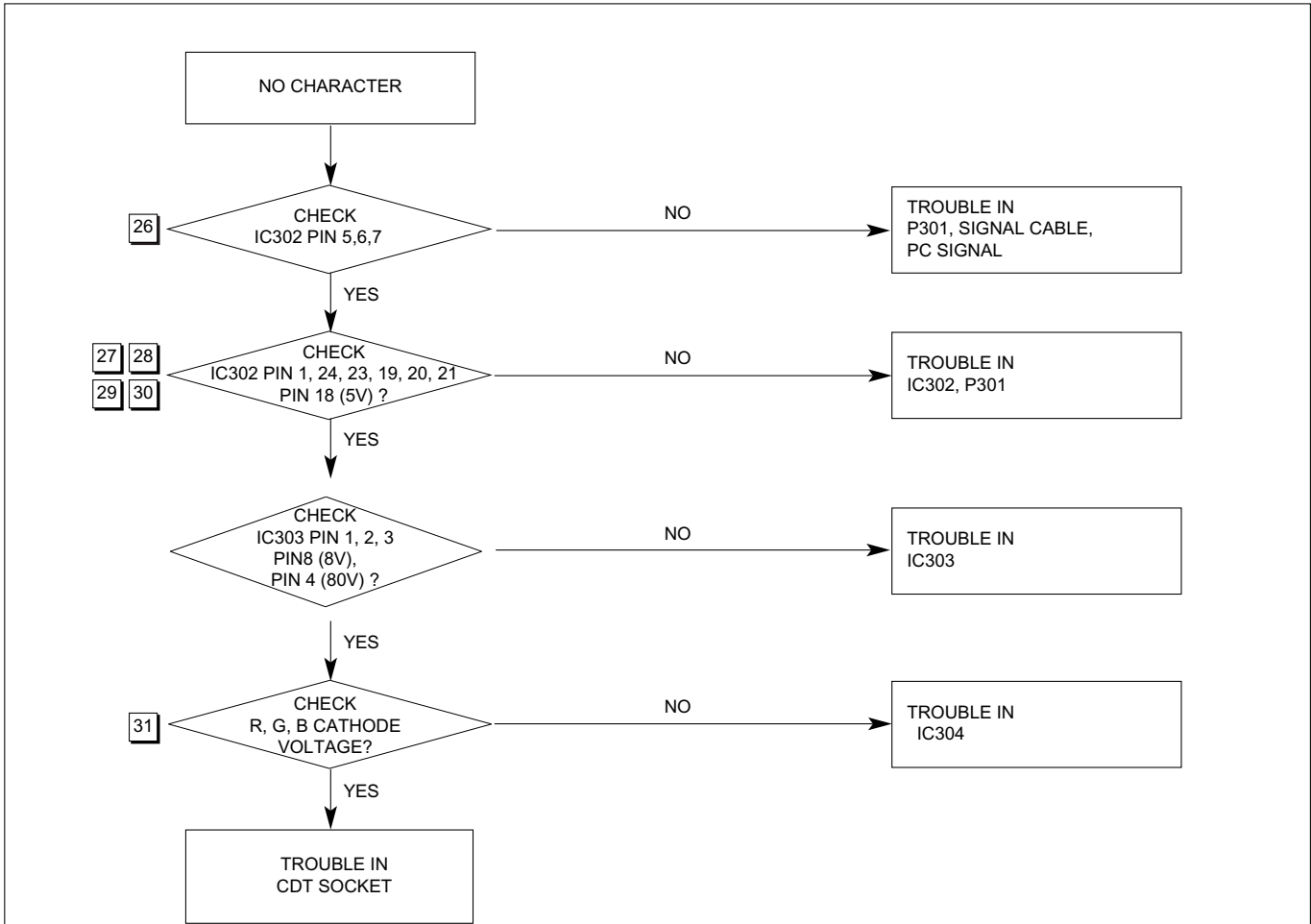

### Waveforms

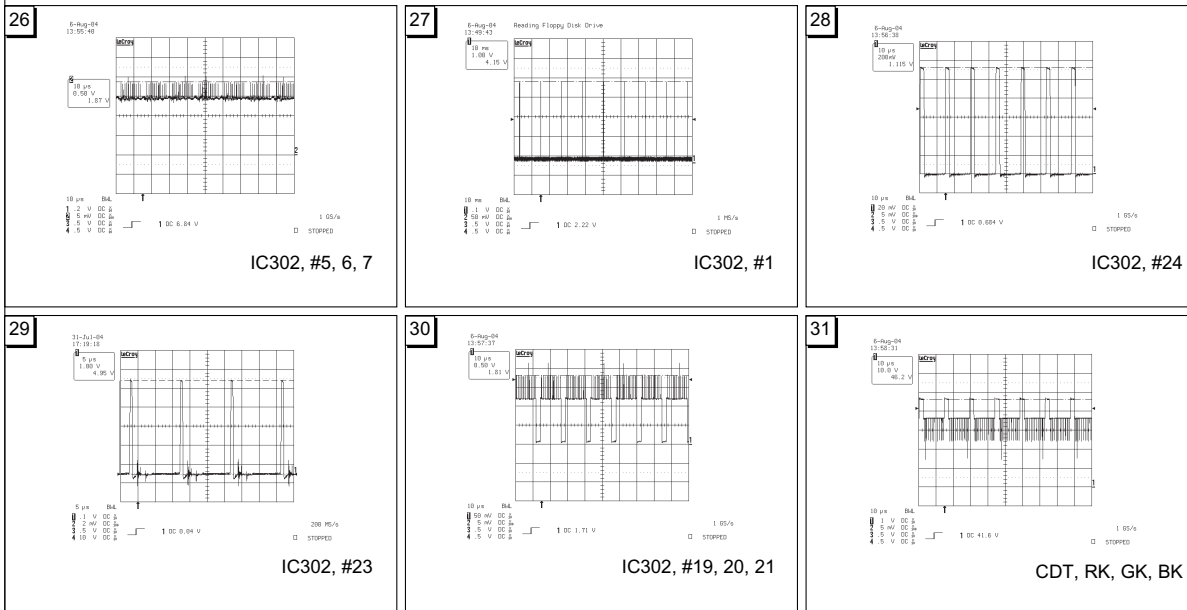

### 3. NO RASTER

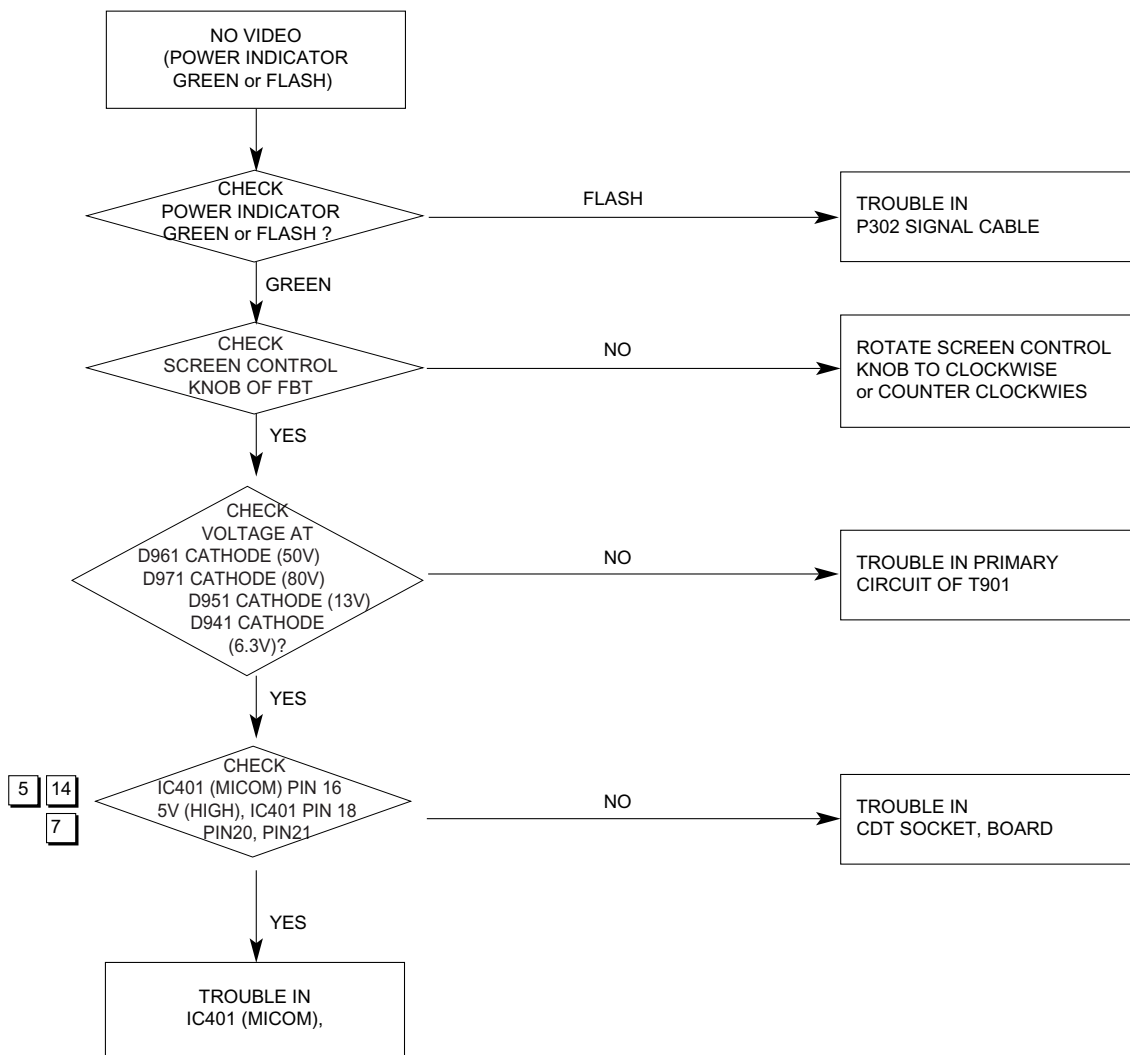

#### Waveforms

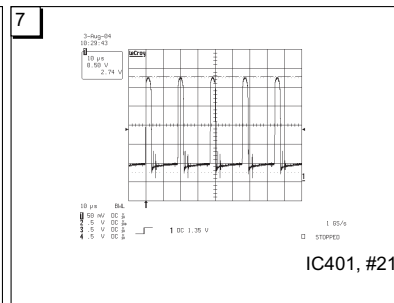
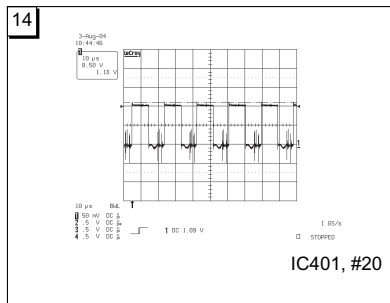
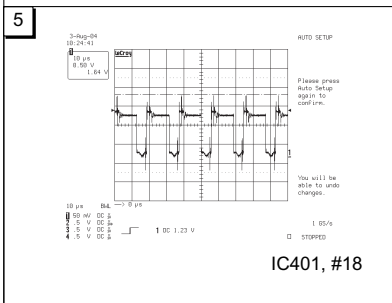

## 4. NO VERTICAL DEFLECTION (ONE HORIZONTAL LINE)

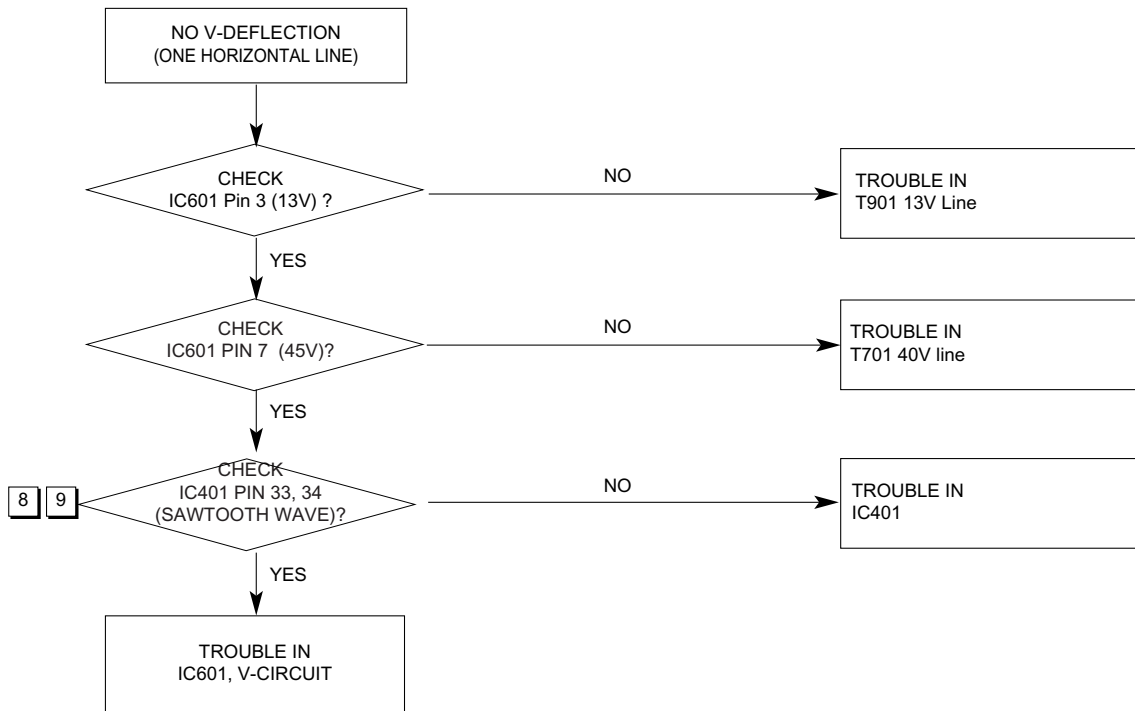

### Waveforms

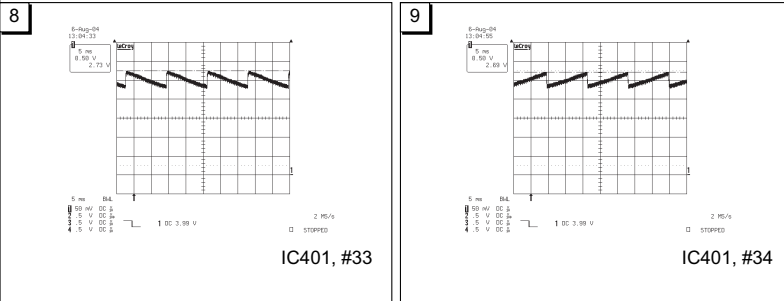

## 5. TROUBLE IN DPM

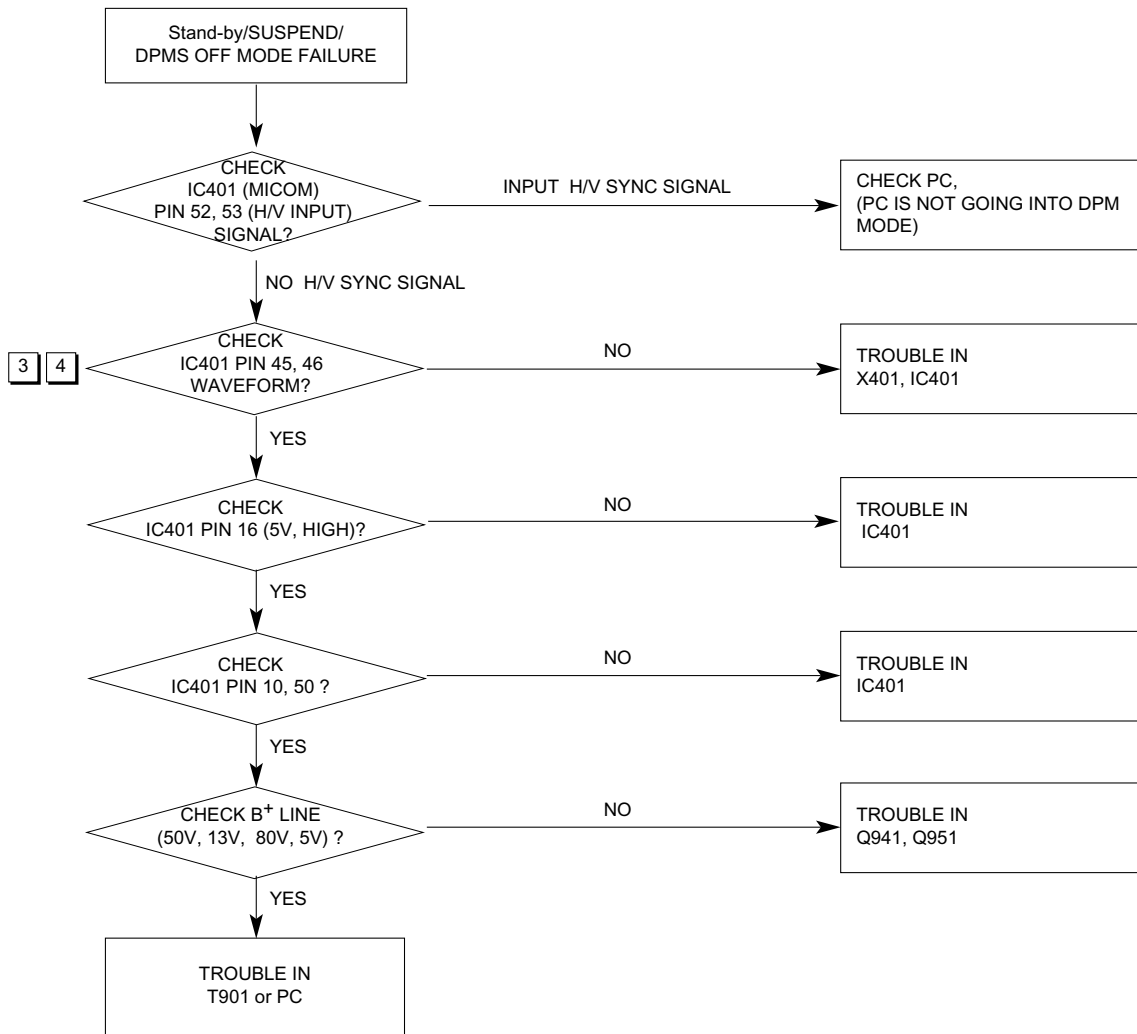

### Waveforms

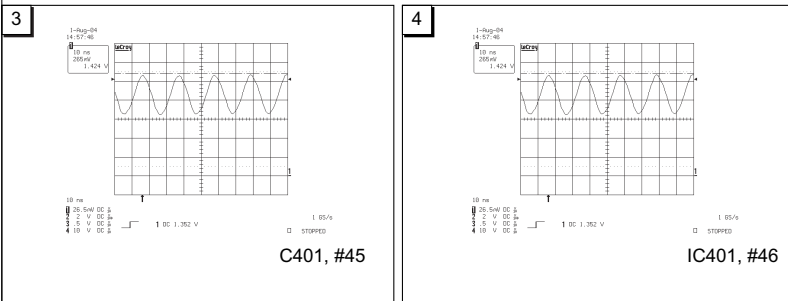

DPMS TABLE

MODE \ ITEM	H/V SYNC	VIDEO	LED
NORMAR	ON/ON	NORMAL	GREEN
STAND-BY	OFF/ON	OFF(0V)	FLASH
SUSPEND	ON/OFF	OFF(0V)	FLASH
OFF	OFF/OFF	OFF(0V)	FLASH

## 6. NO DEGAUSSING

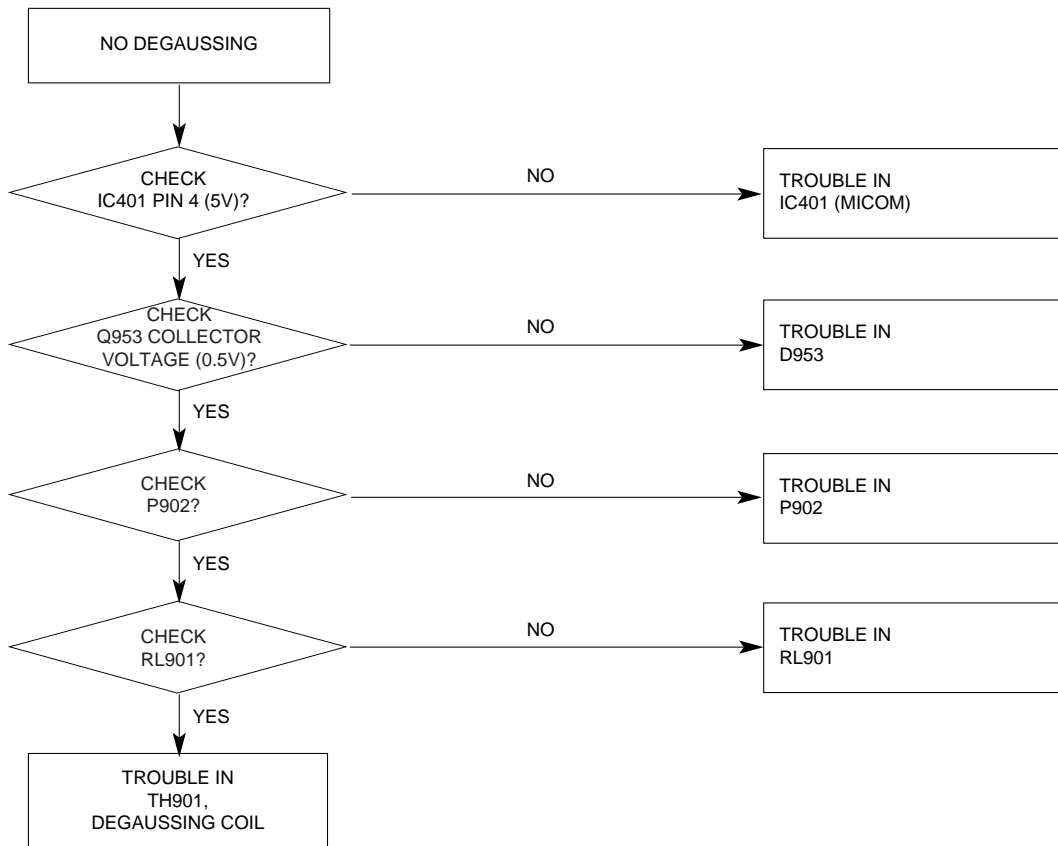

## 7. H\_Deflection Failure

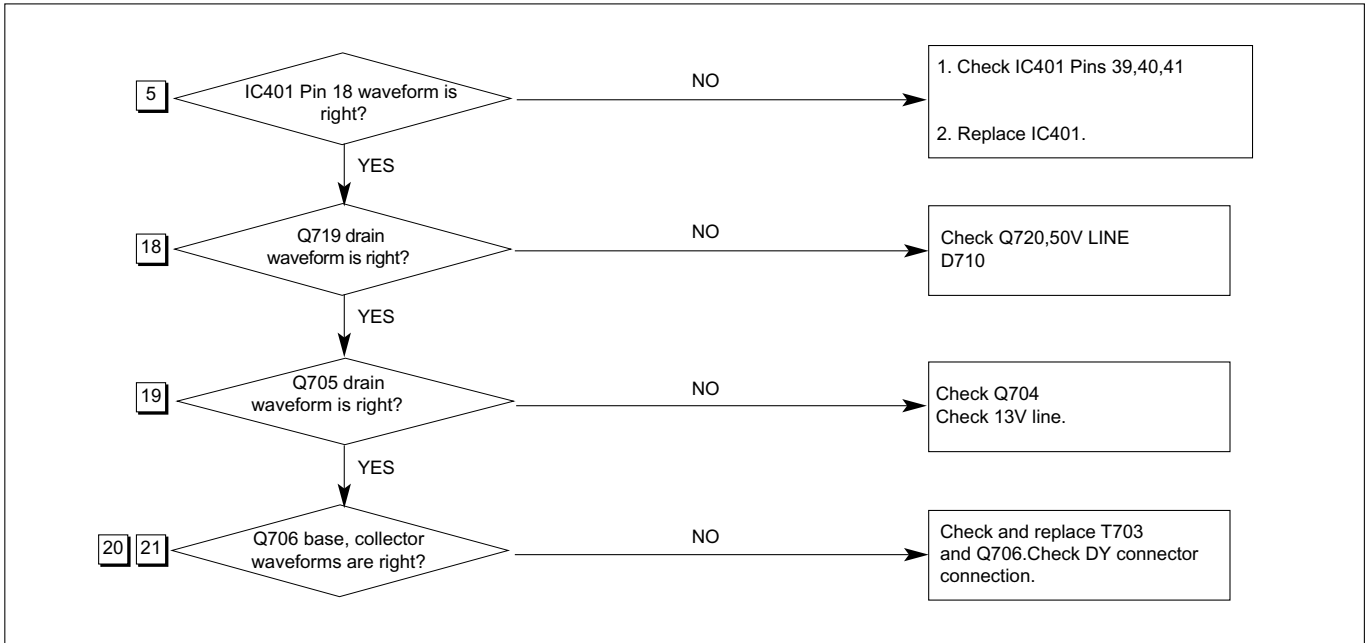

## 8. Invariable H\_Size

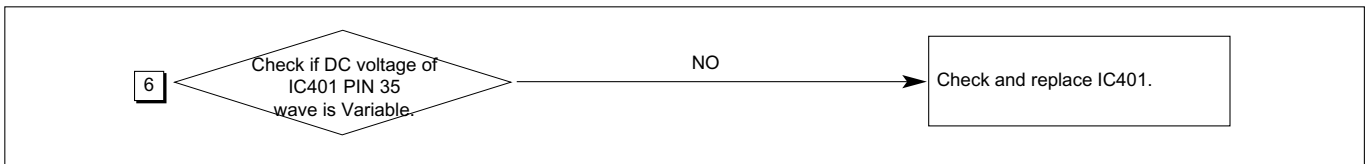

### Waveforms

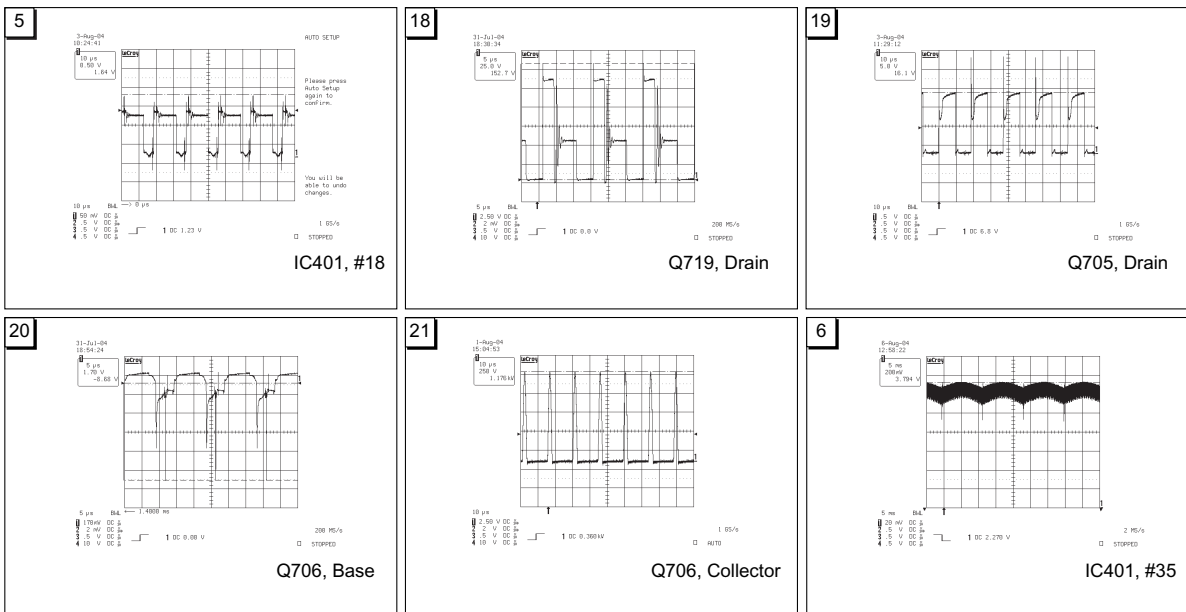



## 9. TROUBLE IN H-LINEARITY

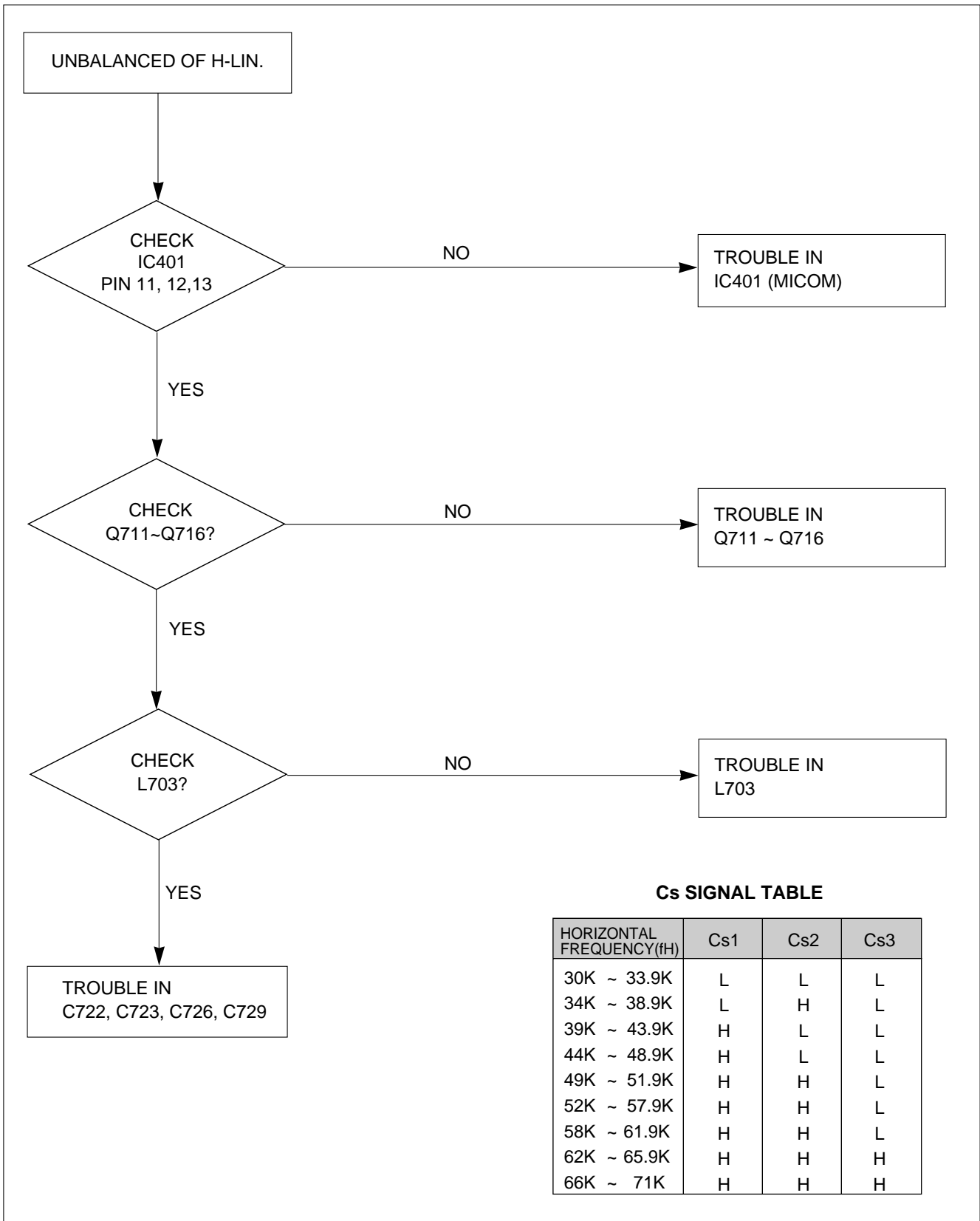

## 10. Abnormal H\_Size

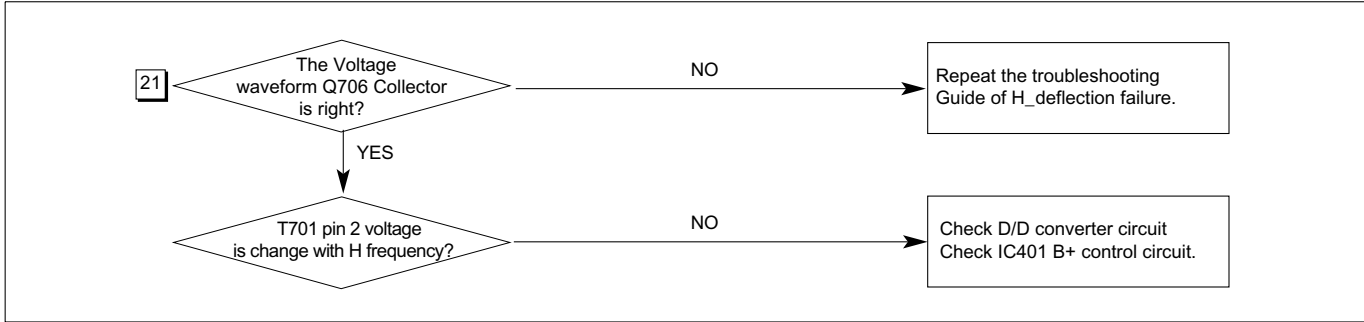

## 11. Side Pin or Trap Failure

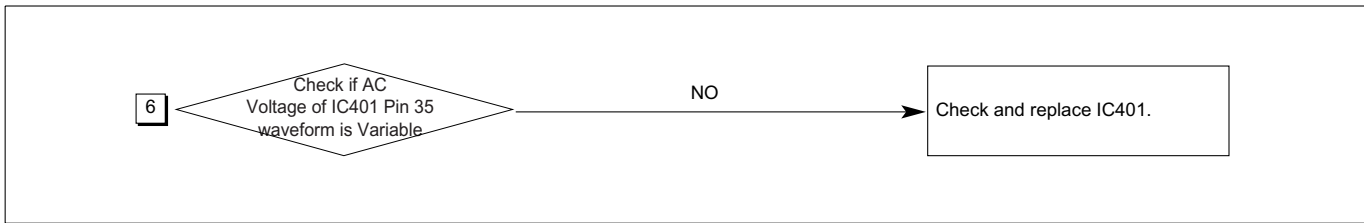

## 12. Para. or Pin Balance Failure



### Waveforms

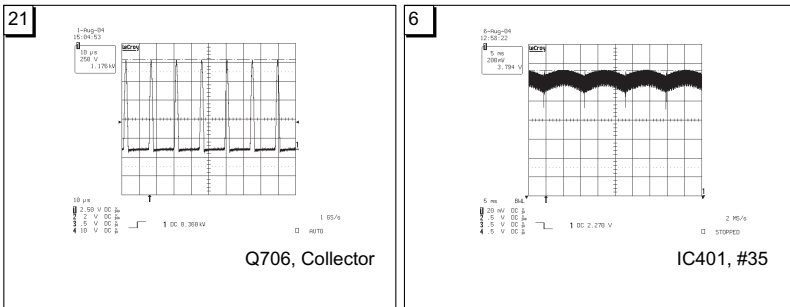

## 13. Tilt Failure

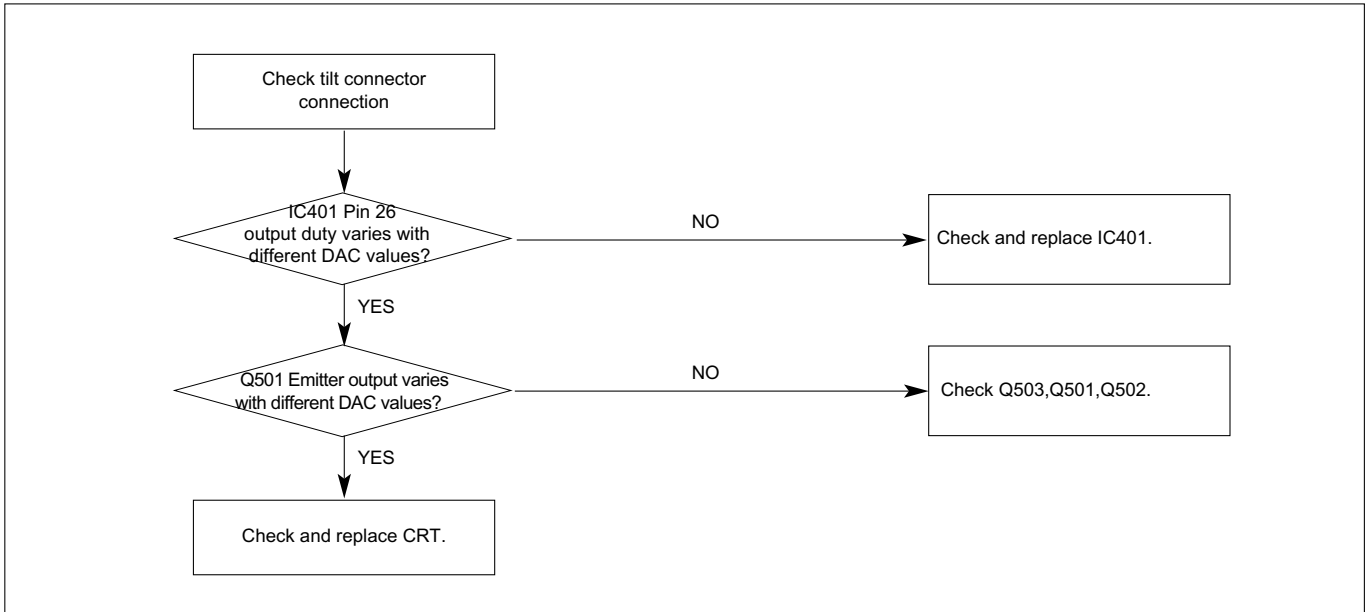

## 14. V Size or Pos. Variation Failure

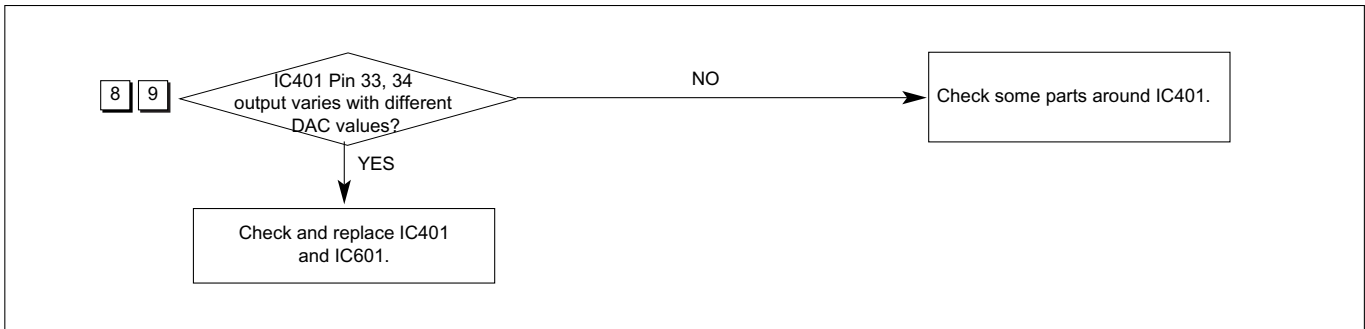

### Waveforms

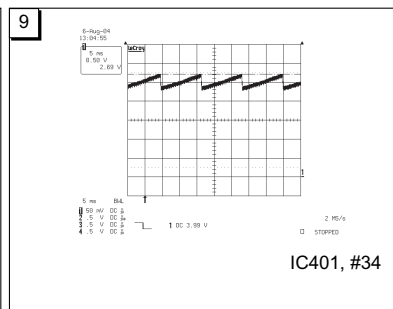
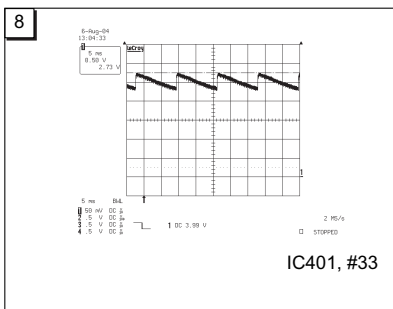

## 15. High Voltage Failure

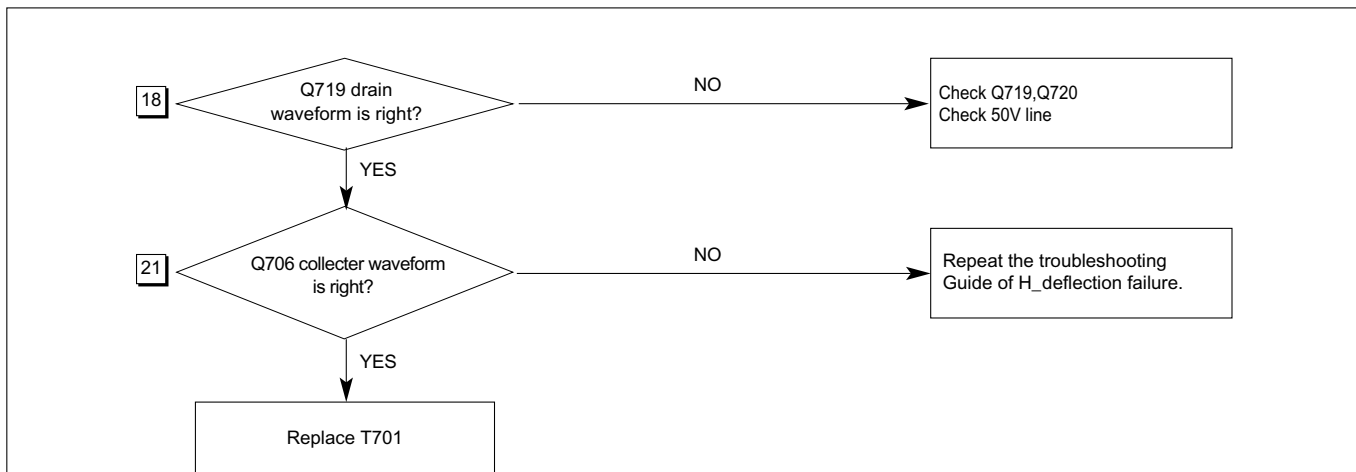

### Waveforms

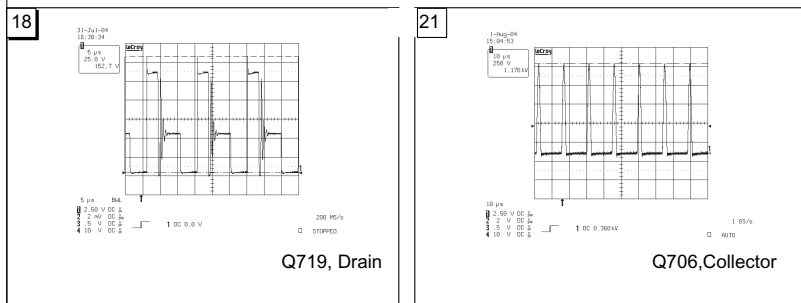

## 16. ABL Failure

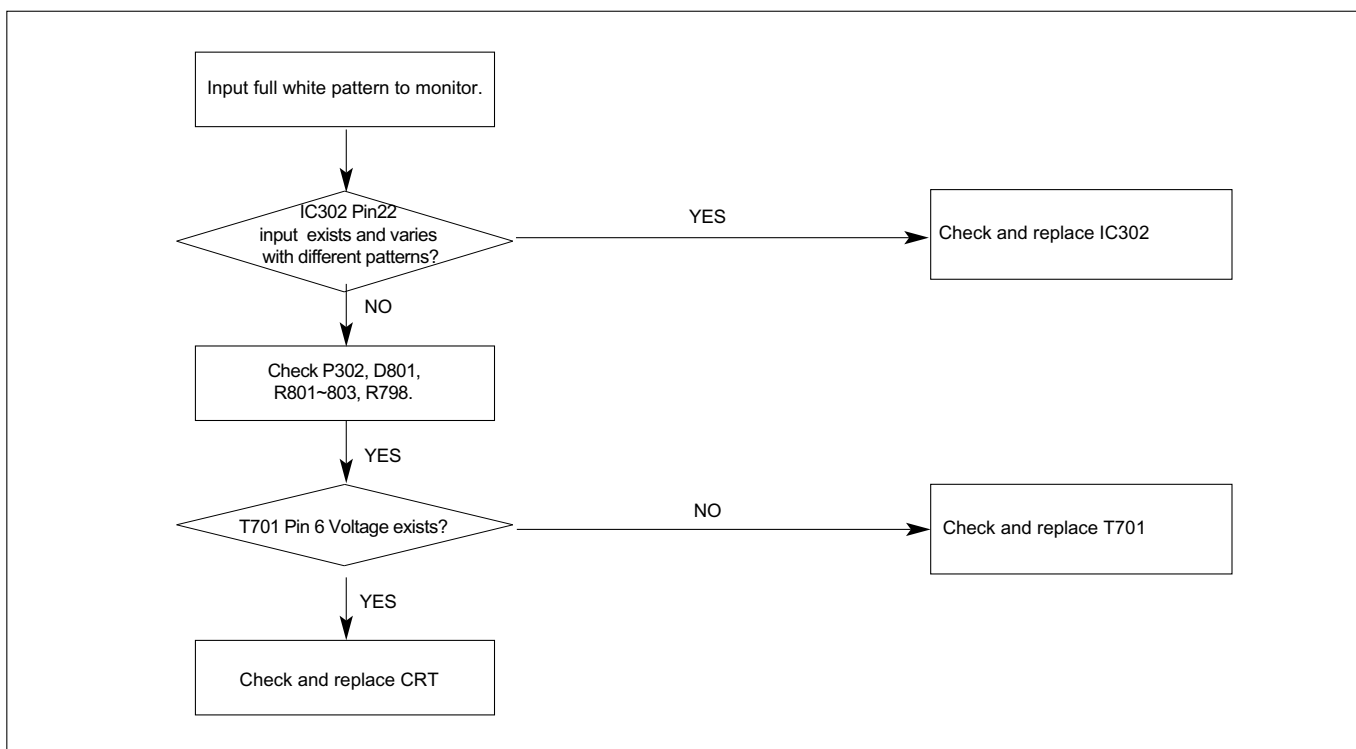

## 17. Focus Failure

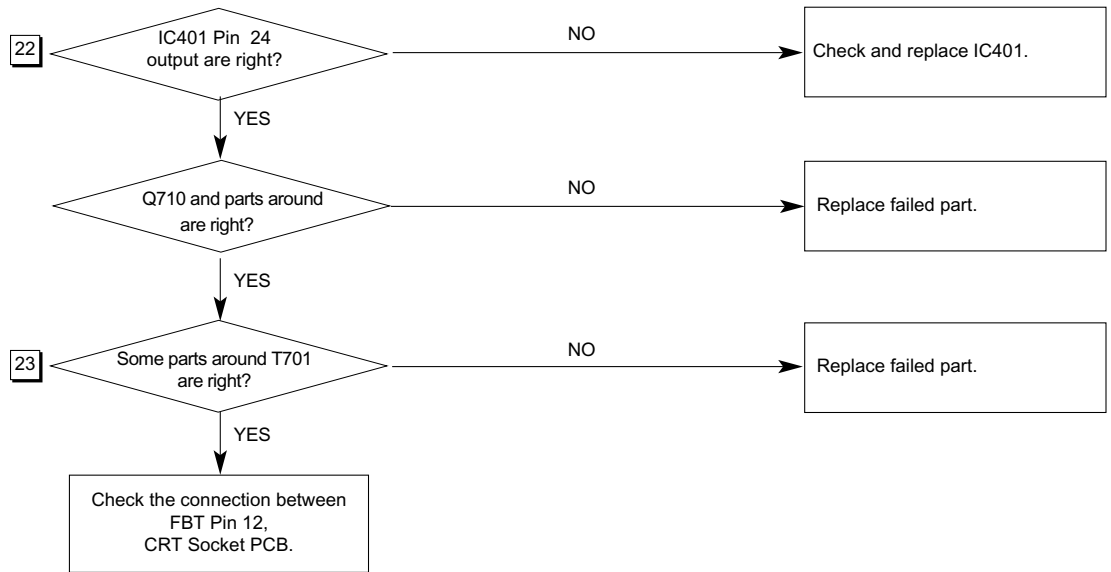

### Waveforms

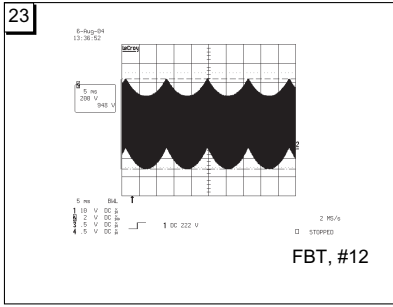
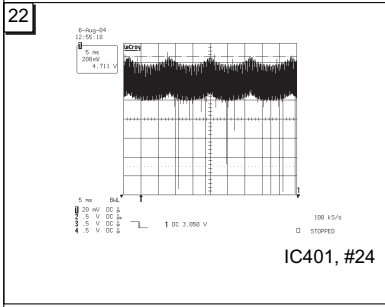

## 18. Micom Failure

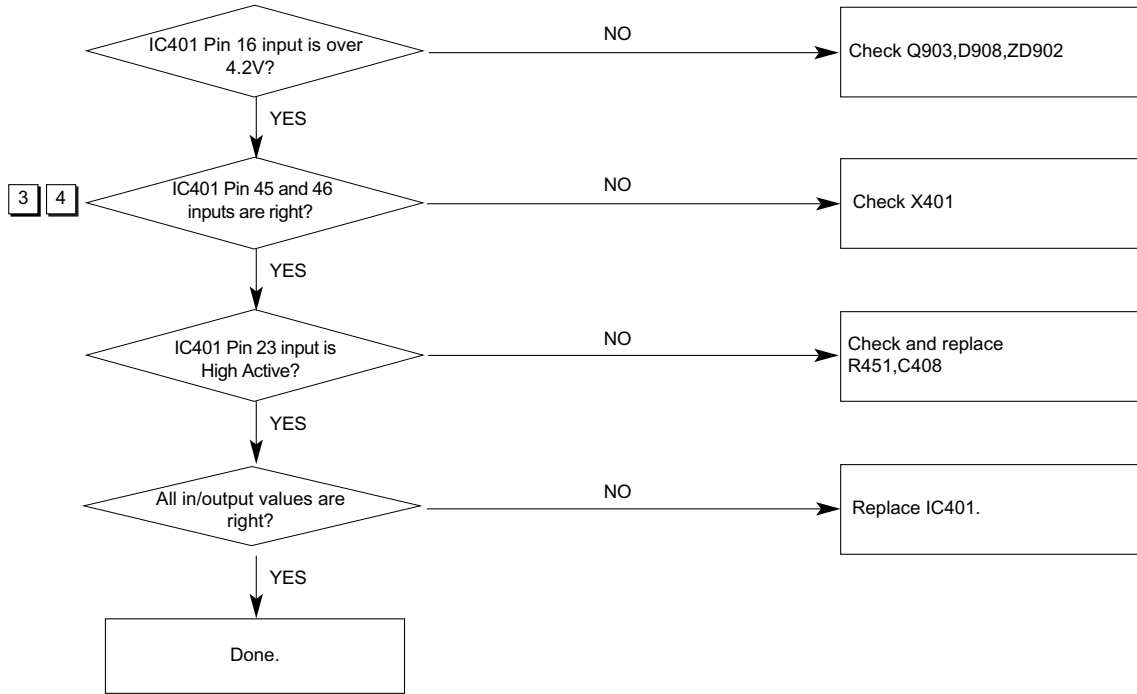

### Waveforms

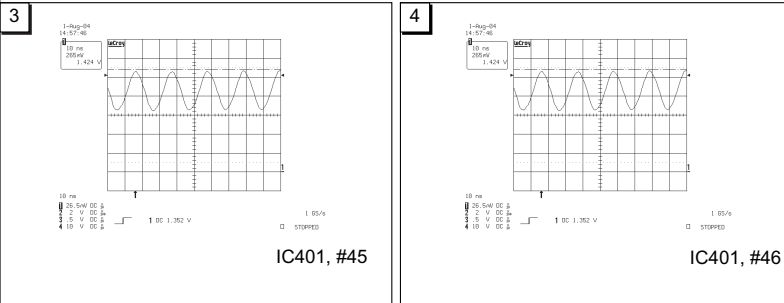

## 19. OSD Failure

Change IC302

## 20. User Control Failure

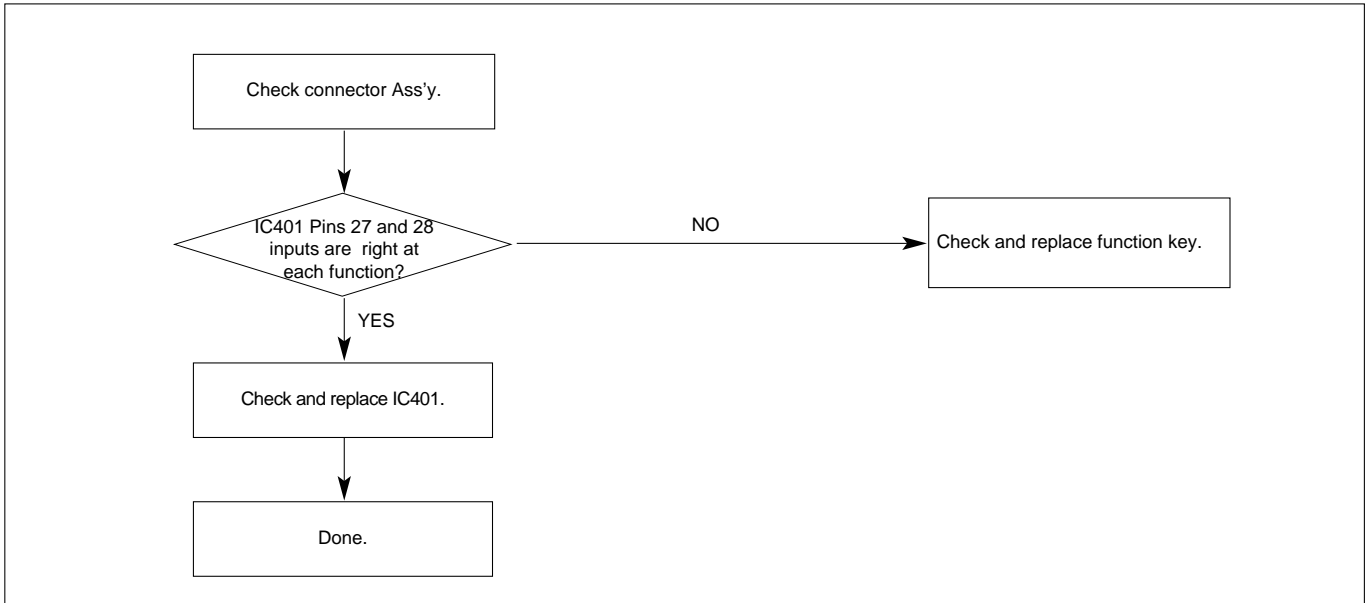

## 21. Missing Color

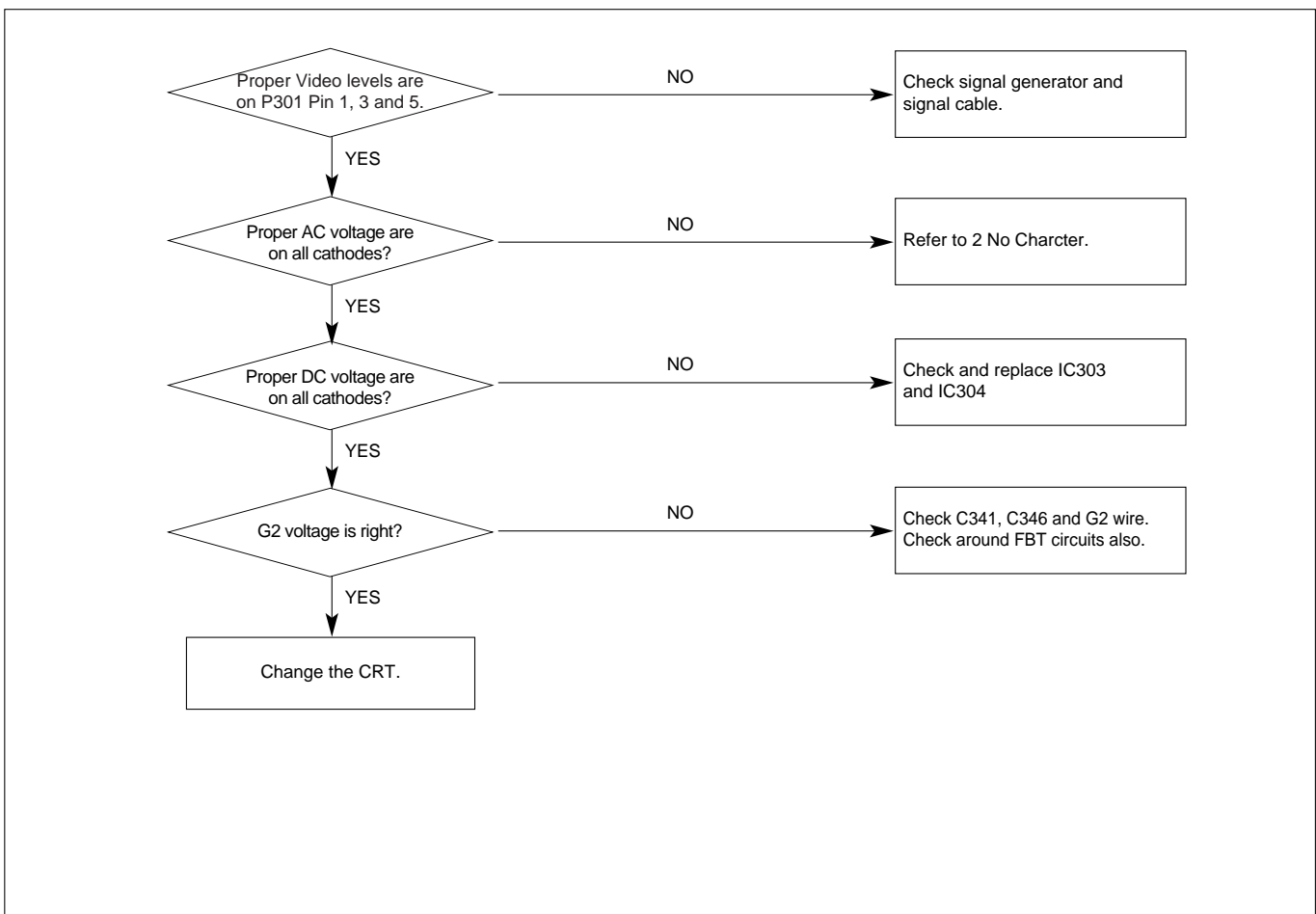

## 22. Visible Retrace

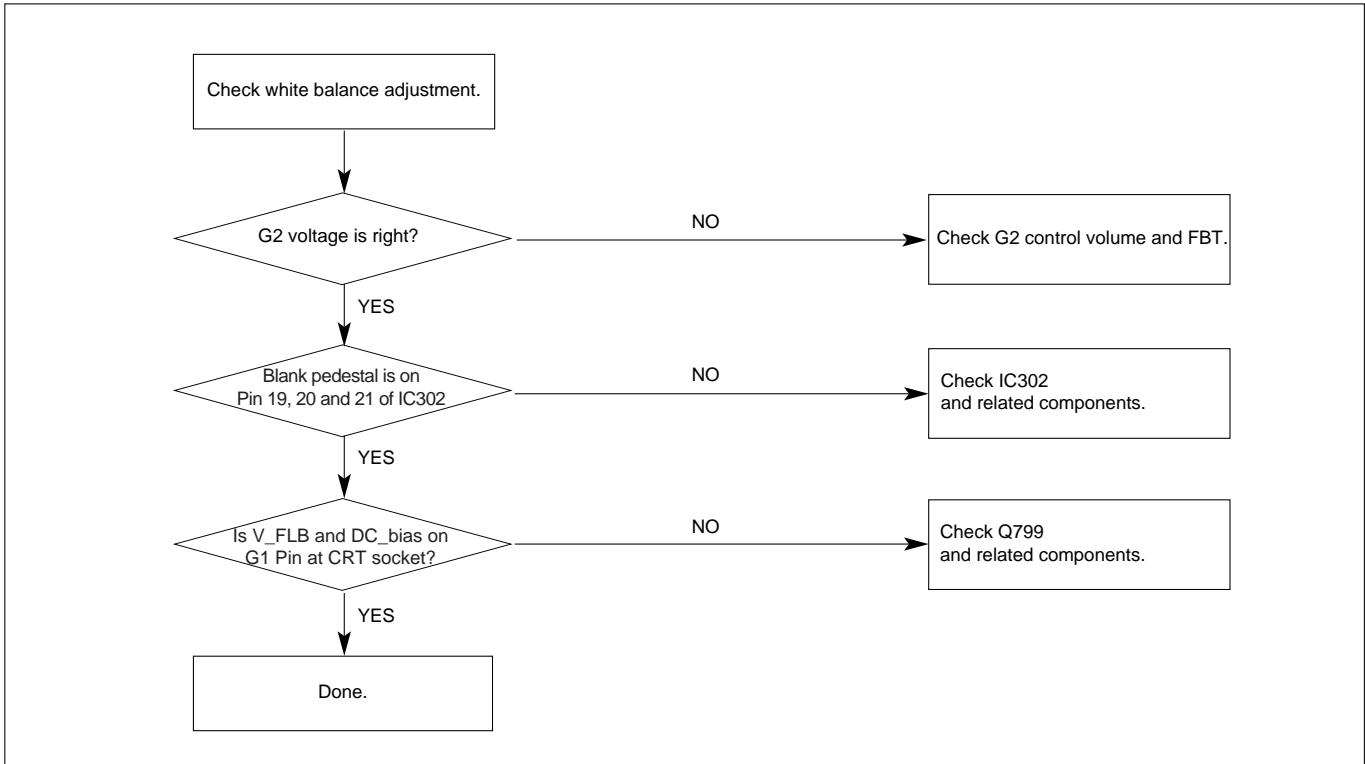

## 23. Purity Failure

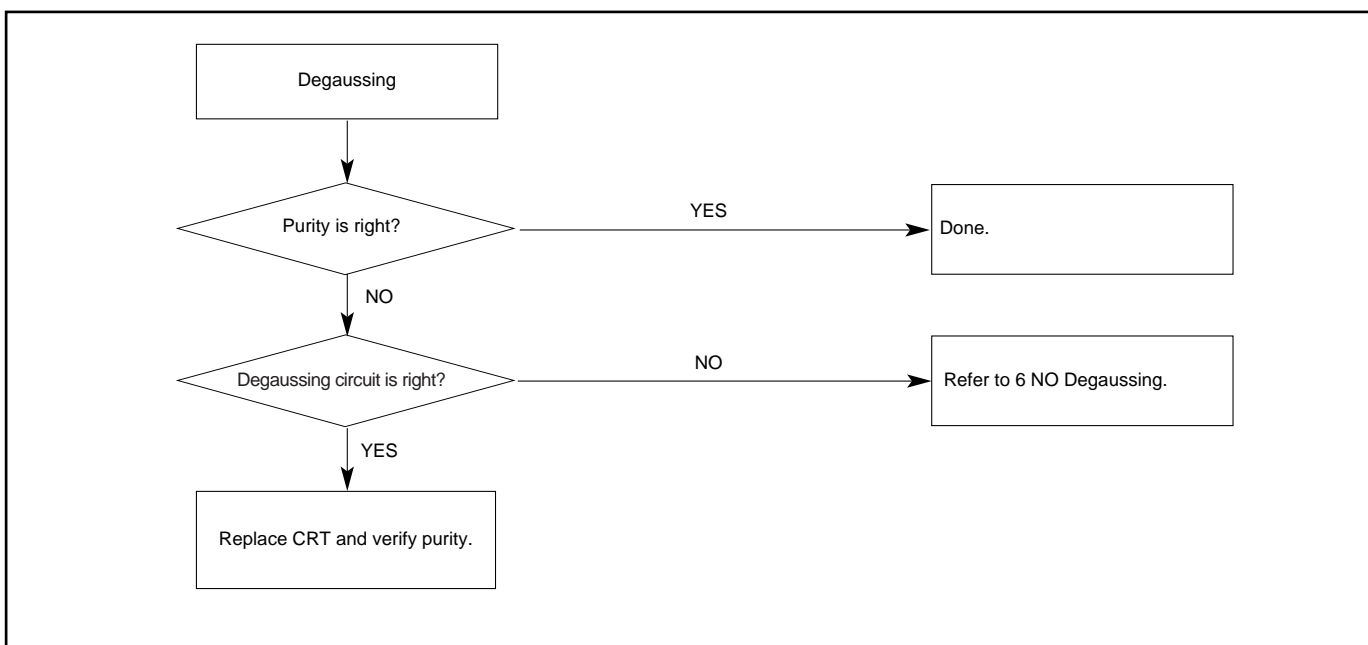



## 24. Misconvergence

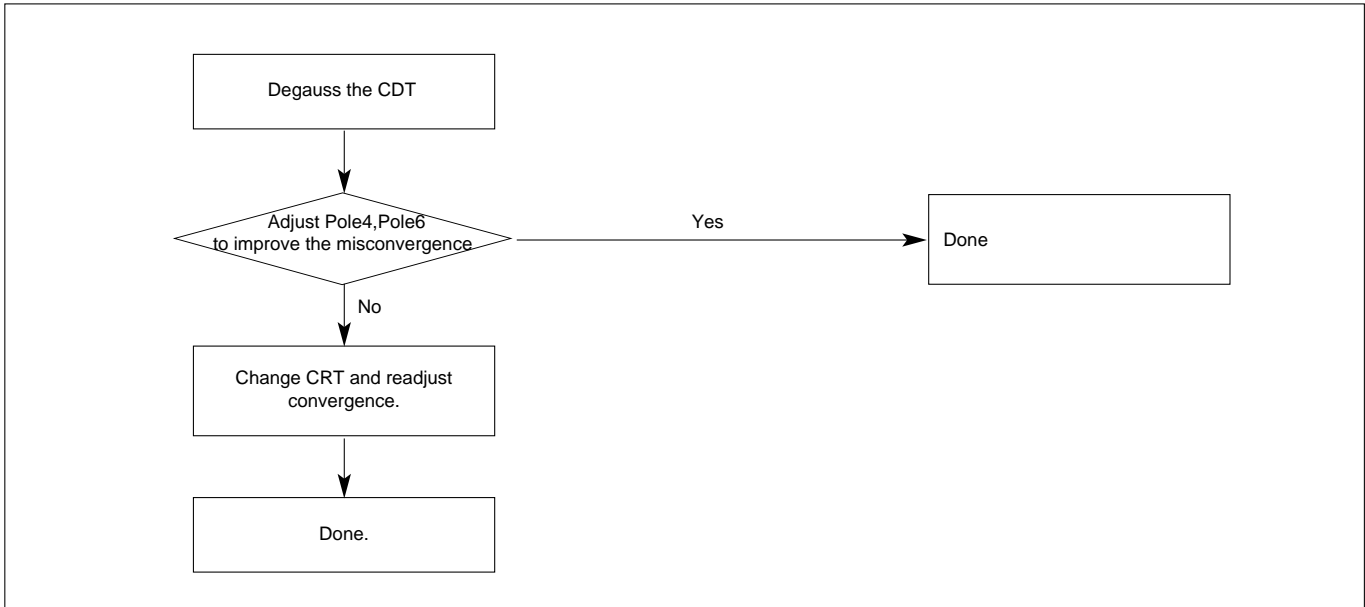

## 25. Poor Focus

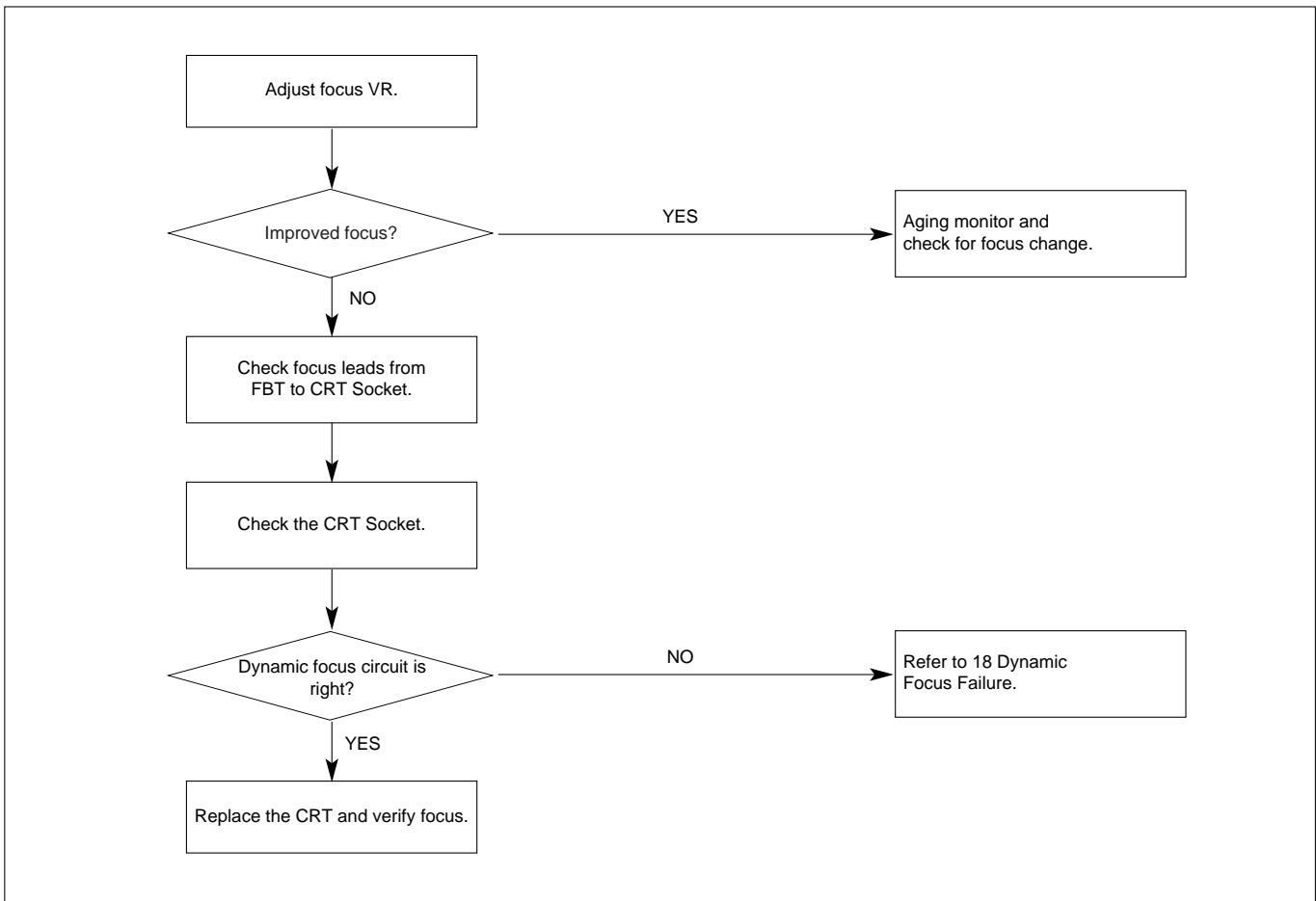

EXPLODED VIEW

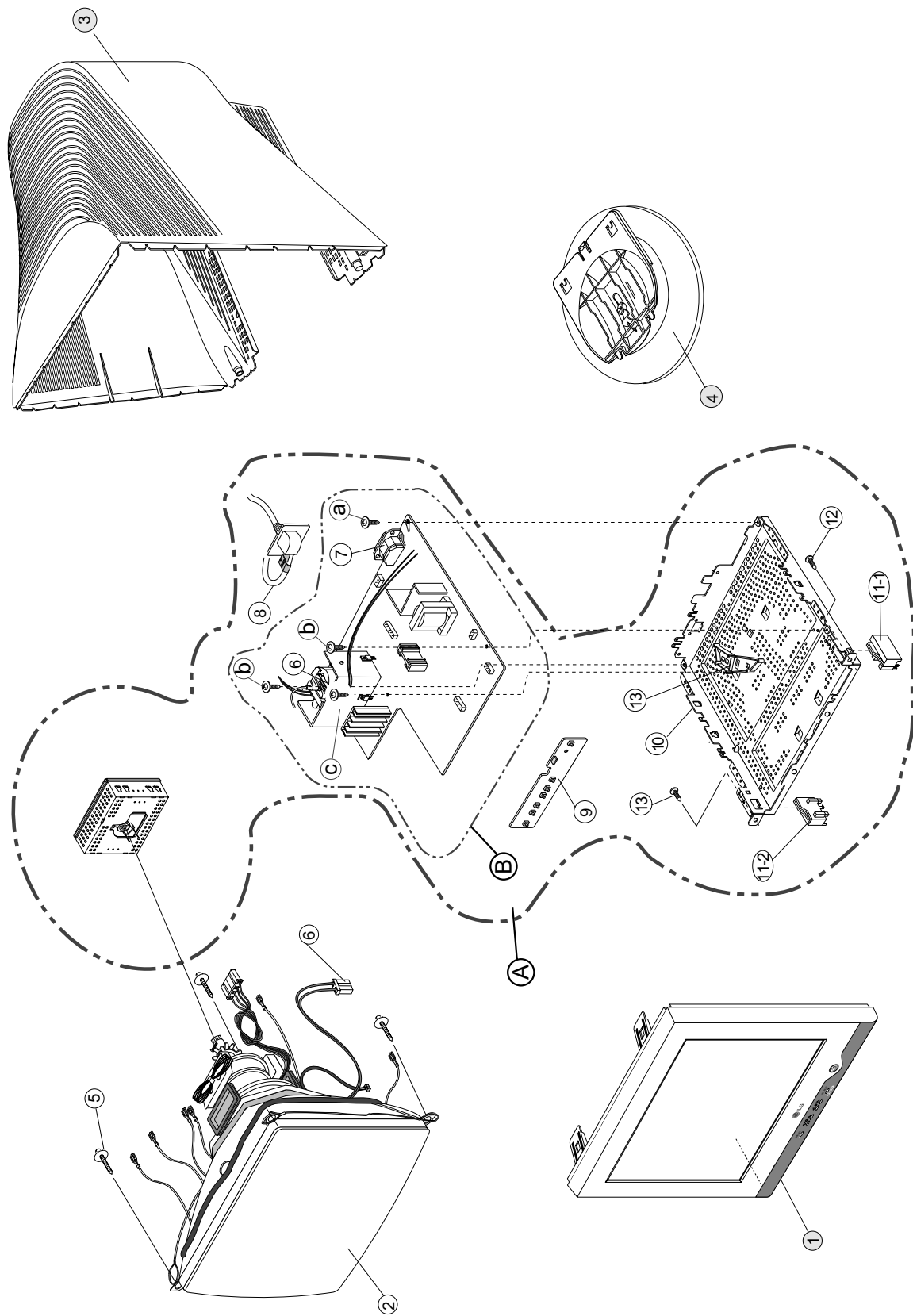

## EXPLODED VIEW PARTS LIST

Ref. No.	Part No.	Description
1	3091TKC089A	CABINET ASSEMBLY, T710BH BRAND C079 5200HF,TCO99,B/VIEW,ER04
	3091TKC089U	CABINET ASSEMBLY, T710BH BRAND C079 5200HF,TCO99,B/VIEW,ER04,DI - For World Wide (T710BH)
	3091TKC089Y	CABINET ASSEMBLY, T710SH BRAND C079 320T(89483),B/VIEW,LG RED,DI(SPRING CKD) - For Mexico, Panama (T710SH)
	3091TKC089W	CABINET ASSEMBLY, T710SH BRAND C079 320T,89483,B/VIEW,DI - For Thailand (T710SH)
	3091TKC089L	CABINET ASSEMBLY, T710B BRAND C079 5008HF, B/VIEW, LABEL CKD ER04 - For Israel (T710BH)
2	6318L17014A	CDT(CIRC), M41QEE903X 01NHU LG-PHILIPS 85KHZ 29.1MM FLAT TCO HB - For Northern Hemisphere
3	3809TKC050B	BACK COVER ASSEMBLY, T710BH/PH C046 GN5008HF, 8C358(EQ54) - For World Wide (T710BH)
	3809TKC050A	BACK COVER ASSEMBLY, T710BH/PH C046 GN5008HF, 8C358(EQ54)
	3809TKC050C	BACK COVER ASSEMBLY, T710 C046 320T,EQ54(8C358) - For Mexico, Panama, Thailand (T710SH)
4	3043TKK136A	TILT SWIVEL ASSEMBLY, E710BH T066 B60 HIPS
5	339-002K	SCREW ASSEMBLY, TAPTITE P TYPE D5.0 L25.0 MSWR/FZMY .
6	6174T11005E	FBT (FLY BACK TRANSFORMER) CP2154/F700BK(17")71K LINE CHANGE
7	6620TKB002D	SOCKET(CIRC),POWER, CDT-3C DUO LING AC UNIVERSAL 3PIN BLACK
	or 6620TKB002B	SOCKET(CIRC),POWER, SA-4S HUA JIE AC UNIVERSAL 3PIN BLACK
8	6850TA9012A	CABLE,D-SUB, UL20276-9C(5.8MM) AT 1560MM GRAY(85964) T710BJ DM
9	6871TST463B	PWB(PCB) ASSEMBLY,SUB, T710BK CONTROL TOTAL BRAND LGENT
	6871TST377E	PWB(PCB) ASSEMBLY,SUB, T710BHJ CONTROL TOTAL BRAND CA-131 - For Israel
10	4950TKS155S	METAL, SHIELD BOTTOM,CB553,0.8T,REAR HOLE DELETE
	4950TKS207A	METAL, SHIELD BOTTOM,CB553,0.8T
	4950TKS212D	METAL, SHIELD BOTTOM C-CKD - For Israel
11-1	4810TKK150A	BRACKET, CN771C SUPPORTER BOT.(RIGHT)
11-2	4810TKK151A	BRACKET, CN771C SUPPORTER BOT.(LEFT)
12	332-102F	SCREW, PTP+4*20BP(MSWR/FZMY)
13	4810TKK204A	BRACKET, CB777H HOLDER FBT
A	3313T17332B	MAIN TOTAL ASSEMBLY, T710BHK BRAND CA-131 LGENT
B	6871TMT496B	PWB(PCB) ASSEMBLY,MAIN, T710BHK KLRDET BRAND CA-131 LGENT
a	332-112F	SCREW,DRAWING, D3.5 L10.0 MSWR/FZMY +SW3.5+RW3.5
b	4001TKK004E	SCREW ASSEMBLY, TAPTITE P TYPE D3.0 L10.0 MSWR/FZMY SW3+RW10
c	332-095B	SCREW,DRAWING, PZP+3*10(MSWR/FZMY)

# REPLACEMENT PARTS LIST

**CAUTION: BEFORE REPLACING ANY OF THESE COMPONENTS,  
READ CAREFULLY THE SAFETY PRECAUTIONS IN THIS MANUAL.**

\* NOTE : S SAFETY Mark  
AL ALTERNATIVE PARTS

DATE:2004.08.08				
*S	*AL	LOC NO.	PART NO.	DESCRIPTION/SPECIFICATON
CAPACITORS				
		C301	0CQ1021N409	0.001UF D 100V 5% PE TP5
		C302	0CE106CF638	Ô10UF SHL,SD 16V M FM5 TP 5Ó
		C303	0CC5600K415	56P 50V J NP0 TP
		C304	0CC5600K415	56P 50V J NP0 TP
		C305	0CE476CF638	Ô47UF SHL,SD 16V M FM5 TP 5Ó
		C306	0CZZTF001M	ECQB1H103JF3 MATSUSHITA 50V 10000PF 5% TAPING 103J
		C307	0CC5600K415	56P 50V J NP0 TP
		C308	0CK1020K515	1000PF 50V K B TR
		C309	0CK1040K945	0.1UF 50V Z F TR
		C311	0CK1040K945	0.1UF 50V Z F TR
		C312	0CK1040K945	0.1UF 50V Z F TR
		C313	0CK1040K945	0.1UF 50V Z F TR
		C314	0CC4700W405	47PF 500V J SL TP
		C315	0CE476EF638	47UF KMG 16V M FM5 TP 5
		C316	0CK10202515	1000PF D 2KV 10% TR B(Y5P)
		C317	0CK1040K945	0.1UF 50V Z F TR
		C318	0CK1040K945	0.1UF 50V Z F TR
		C319	0CK1040K945	0.1UF 50V Z F TR
		C320	0CK10202515	1000PF D 2KV 10% TR B(Y5P)
		C321	0CE225CK638	Ô2.2UF SHL,SD 50V M FM5 TP 5Ó
		C323	0CE476CF638	Ô47UF SHL,SD 16V M FM5 TP 5Ó
		C324	0CK1040K945	0.1UF 50V Z F TR
		C325	181-288B	MKT 100V 104JTR PHS26104
		C326	0CC2200W415	22PF 500V J NP0 TR
		C327	181-288B	MKT 100V 104JTR PHS26104
		C328	0CE226EN638	22UF KMG 100V M FM5 TP 5
		C329	181-288B	MKT 100V 104JTR PHS26104
		C330	181-288B	MKT 100V 104JTR PHS26104
		C331	181-288G	MKT 100V 334JTR PHS26334
		C332	181-288G	MKT 100V 334JTR PHS26334
		C333	181-288G	MKT 100V 334JTR PHS26334
		C334	181-288B	MKT 100V 104JTR PHS26104
		C335	181-288B	MKT 100V 104JTR PHS26104
		C339	0CK1520W515	1500P 500V K B TS
		C340	181-288B	MKT 100V 104JTR PHS26104
		C341	0CK10202515	1000PF D 2KV 10% TR B(Y5P)
		C344	181-288B	MKT 100V 104JTR PHS26104
		C346	0CK10302940	0.01M 2KV Z F S
		C372	0CK1040K945	0.1UF 50V Z F TR
		C401	0CK1040K945	0.1UF 50V Z F TR
		C404	0CK1040K945	0.1UF 50V Z F TR
		C405	0CE107CF638	Ô100UF SHL,SD 16V M FM5 TP 5Ó
		C406	0CK10102515	100PF D 2KV 10% B(Y5P) TR
		C407	0CQ4721N409	0.0047UF D 100V 5% PE TP5
		C408	0CK1040K945	0.1UF 50V Z F TR
		C409	0CE106CF638	Ô10UF SHL,SD 16V M FM5 TP 5Ó
		C410	0CK1010K515	100PF 50V K B TR
		C411	0CK1010K515	100PF 50V K B TR
		C412	0CK1020K515	1000PF 50V K B TR
		C413	0CK1010K515	100PF 50V K B TR
		C414	0CE106CF638	Ô10UF SHL,SD 16V M FM5 TP 5Ó
		C415	0CK2220K515	2200P 50V K B TS
		C416	0CQ1031N409	0.01U 100V J POLY TP
		C417	0CK1040K945	0.1UF 50V Z F TR
		C419	0CQ2221N409	2200PF 100V J PE TP
		C420	0CQ6831N509	0.068U 100V K POLY TP
		C421	0CK1020K515	1000PF 50V K B TR

DATE:2004.08.08				
*S	*AL	LOC NO.	PART NO.	DESCRIPTION/SPECIFICATON
		C422	0CK2220K515	2200P 50V K B TS
		C423	0CK2220K515	2200P 50V K B TS
		C424	0CE475CK638	Ô4.7UF SHL,SD 50V M FM5 TP 5Ó
		C426	0CK4710K515	470PF 50V K B TR
		C427	0CK4710K515	470PF 50V K B TR
		C501	0CE106CF638	Ô10UF SHL,SD 16V M FM5 TP 5Ó
		C601	0CE227EF638	Ô220UF KMG,RD 16V 20% TP 5 FM5Ó
		C602	181-288K	MKT 100V 683JTR PHS26683
		C603	0CE107EK638	100UF KMG 50V M FM5 TP 5
		C604	0CZZTF001V	ECQB1H473JM3 473J 50V TP5.0 MATSUSHITA
		C605	0CK1020W515	1000P 500V K B TS
		C701	0CK1040K945	0.1UF 50V Z F TR
		C712	0CK1040K945	0.1UF 50V Z F TR
		C713	0CK2210K515	220P 50V K B TS
		C714	0CE107CH638	Ô100UF SHL,SD 25V M FM5 TP 5Ó
		C715	181-288N	MKT 100V 103JTR PHS86103
		C719	0CZZTAB001F	SHL-BP SYE / SWE 50V 3.3UF 20% BULK EB770H
		C720	0CK10201515	1000P 1KV K B TS
		C722	181-303E	224J 30.0*19.5*12.0*20.0 250V J PU FM20
		C723	181-305B	124J 19.0*13.5*7.5*10.0 250V J MPP FM10
		C724	0CK1040K945	0.1UF 50V Z F TR
		C726	181-305F	MPP 250V 274J S=10.0
		C727	0CK1040K945	0.1UF 50V Z F TR
		C729	181-305L	684J 26.0*19.0*12.5*15.0 250V J MPP FM15
		C730	0CK1040K945	0.1UF 50V Z F TR
	⚠	C731	0CBZTBU004H	5600PF D 2.5KV H MPP NI FM20
		C733	0CBZTBU003H	362J 20.0*12.0*7.0*10.0 800V J BUP FM10
		C738	181-302M	822J 19.5*12.0*7.0*10.0 250V J PU FM10
		C739-1	0CE106CN638	Ô10UF SHL,SD 100V M FM5 TP 5Ó
		C740	0CE227EL630	220UF KMG 63V M FM5 BULK
		C741	0CZZTF002B	ECQV1H154JZ3 154J 50V TP5.0 MATSUSHITA
		C744	181-305L	684J 26.0*19.0*12.5*15.0 250V J MPP FM15
		C745	0CK5610W515	560P 500V K B TS
		C748	0CK1510W515	150PF 500V K B TR
		C749	0CE4756Q638	4.7000UF SMS 200V M FM5 TP5
		C750	0CK1040K945	0.1UF 50V Z F TR
		C756	0CK4700K515	47PF D 50V 10% B(Y5P) TR
		C767	0CK10301945	10000PF D 1KV Z F(Y5V) TR
		C801	0CK1040K945	0.1UF 50V Z F TR
	⚠	C901	0CZZTFB001B	BULK MPX 474K2YL (X2) BULK 22.5
	⚠	C902	0CZZTFB001C	ÔMPX104K2YL ETR 275V 0.1UF 10%, -10% BULK X2Ó
	⚠	C903	0CZZTCB003D	BULK 7.5 CS E 102M 8.0 250V TDK
	⚠	C904	0CZZTCB003A	BULK 7.5 CS E 222M 10.5 250V TDK
	⚠	C905	0CZZTCB003A	BULK 7.5 CS E 222M 10.5 250V TDK
	⚠	C906	0CZZTCB003D	BULK 7.5 CS E 102M 8.0 250V TDK
		C907	0CKZTBU003C	SC E 472M 14.0BW7 250V BK7.5 SAMWHA Y2
		C908	0CEZTBU002D	180UF 25.4*35 SMH/HC 400V M VNSN BULK
		C909	0CK10301945	10000PF D 1KV Z F(Y5V) TR
		C910	0CK22101515	220P 1KV K B TP5
		C911	0CE475CK638	Ô4.7UF SHL,SD 50V M FM5 TP 5Ó

DATE:2004.08.08				
*S	*AL	LOC NO.	PART NO.	DESCRIPTION/SPECIFICATON
		C912	0CK3310K515	330P 50V K B TS
		C913	0CE476CK638	Ò47UF SHL,SD 50V M FM5 TP 5Ó
		C914	0CZZTFT001P	ECQB1H153JM3 153J 50V TP5.0 MATSUSHITA
		C915	0CK6810K515	680P 50V K B TS
		C917	0CK1020K515	1000PF 50V K B TR
		C918	0CK1040K945	0.1UF 50V Z F TR
		C921	0CZZTCB003A	BULK 7.5 CS E 222M 10.5 250V TDK
		C941	0CE108CD618	1000UF SHL 10V M FL TP5
		C942	0CE107CF638	Ò100UF SHL,SD 16V M FM5 TP 5Ó
		C943	0CK56101515	560P 1KV K B TS
		C951	0CE108CF630	1000UF SHL 16V M FM5 BULK
		C952	0CE107CF638	Ò100UF SHL,SD 16V M FM5 TP 5Ó
		C953	0CE107CF638	Ò100UF SHL,SD 16V M FM5 TP 5Ó
		C954	0CE108CD618	1000UF SHL 10V M FL TP5
		C971	0CE476EK638	47UF KMG 50V M FM5 TP 5
		C998	0CE227EL630	220UF KMG 63V M FM5 BULK
DIODEs				
		D301	0DSPT00029A	1N4148M PCTRONIX TP DO34 100V 75VA 2000MA 4NSEC 0.025UA
		D302	0DSPT00029A	1N4148M PCTRONIX TP DO34 100V 75VA 2000MA 4NSEC 0.025UA
		D303	0DSPT00029A	1N4148M PCTRONIX TP DO34 100V 75VA 2000MA 4NSEC 0.025UA
		D304	0DSPT00029A	1N4148M PCTRONIX TP DO34 100V 75VA 2000MA 4NSEC 0.025UA
		D305	0DSPT00029A	1N4148M PCTRONIX TP DO34 100V 75VA 2000MA 4NSEC 0.025UA
		D306	0DSPT00029A	1N4148M PCTRONIX TP DO34 100V 75VA 2000MA 4NSEC 0.025UA
		D307	0DSPT00029A	1N4148M PCTRONIX TP DO34 100V 75VA 2000MA 4NSEC 0.025UA
		D308	0DSPT00029A	1N4148M PCTRONIX TP DO34 100V 75VA 2000MA 4NSEC 0.025UA
		D309	0DSPT00029A	1N4148M PCTRONIX TP DO34 100V 75VA 2000MA 4NSEC 0.025UA
		D310	0DSPT00019A	PSS244 PCTRONIX TP DO34 280V 625MA 1000MA 50NSSEC 10UA
		D311	0DSPT00019A	PSS244 PCTRONIX TP DO34 280V 625MA 1000MA 50NSSEC 10UA
		D312	0DSPT00019A	PSS244 PCTRONIX TP DO34 280V 625MA 1000MA 50NSSEC 10UA
		D313	0DSPT00019A	PSS244 PCTRONIX TP DO34 280V 625MA 1000MA 50NSSEC 10UA
		D314	0DSPT00019A	PSS244 PCTRONIX TP DO34 280V 625MA 1000MA 50NSSEC 10UA
		D315	0DSPT00019A	PSS244 PCTRONIX TP DO34 280V 625MA 1000MA 50NSSEC 10UA
		D316	0DRTW00119A	1N4005-1021 TIWAN SEMI TP DO41 600V 1A 30A 2USSEC 5.0UA
		D401	0DSPT00029A	1N4148M PCTRONIX TP DO34 100V 75VA 2000MA 4NSEC 0.025UA
		D402	0DSPT00029A	1N4148M PCTRONIX TP DO34 100V 75VA 2000MA 4NSEC 0.025UA
		D403	0DSPT00029A	1N4148M PCTRONIX TP DO34 100V 75VA 2000MA 4NSEC 0.025UA
		D406	0DSPT00019A	PSS244 PCTRONIX TP DO34 280V 625MA 1000MA 50NSSEC 10UA
		D407	0DSPT00029A	1N4148M PCTRONIX TP DO34 100V 75VA 2000MA 4NSEC 0.025UA
		D501	0DSPT00029A	1N4148M PCTRONIX TP DO34 100V 75VA 2000MA 4NSEC 0.025UA
		D703	0DRGF00120A	MUR460(15MM) GULF BK DO201AD 600V 4A 150A 45NSSEC 10UA
		D704	0DRFC00300A	FFPF04U150S FAIR CHILD BK TO220F

DATE:2004.08.08				
*S	*AL	LOC NO.	PART NO.	DESCRIPTION/SPECIFICATON
		D705	0DRTW00089A	1500V 4A 40A 150NSSEC 7UA SRT14(1021) TIWAN SEMI TP NON 40V 1A 25A .SEC 0.5MA
		D706	0DRFC00300A	FFPF04U150S FAIR CHILD BK TO220F 1500V 4A 40A 150NSSEC 7UA
		D710	0DR400409AC	UF4004 GULF TP DO41 400V 1A 30A 50NSEC 10UA
		D712	0DR100009CD	RGP10G-1021 TIWAN SEMI TP DO41 400V 1A 30A 150NSEC 5UA
		D714	0DSPT00029A	1N4148M PCTRONIX TP DO34 100V 75VA 2000MA 4NSEC 0.025UA
		D715	0DSPT00029A	1N4148M PCTRONIX TP DO34 100V 75VA 2000MA 4NSEC 0.025UA
		D716	0DRTW00119A	1N4005-1021 TIWAN SEMI TP DO41 600V 1A 30A 2USSEC 5.0UA
		D717	0DRTW00119A	1N4005-1021 TIWAN SEMI TP DO41 600V 1A 30A 2USSEC 5.0UA
		D718	0DRTW00119A	1N4005-1021 TIWAN SEMI TP DO41 600V 1A 30A 2USSEC 5.0UA
		D719	0DR100009DC	RGP10J-1021 TIWAN SEMI TP DO41 600V 1A 30A 250NSEC 5UA
		D721	0DR100009CD	RGP10G-1021 TIWAN SEMI TP DO41 400V 1A 30A 150NSEC 5UA
		D723	0DSPT00029A	1N4148M PCTRONIX TP DO34 100V 75VA 2000MA 4NSEC 0.025UA
		D768	0DD400709CC	UF4007-1021 TIWAN SEMI TP DO204AL 1000V 1A 30A 75NSEC 10UA
		D801	0DSPT00029A	1N4148M PCTRONIX TP DO34 100V 75VA 2000MA 4NSEC 0.025UA
		D900	0DRTW00121A	D2SB60-1121 TIWAN SEMI ST GBL 600V 2A 80A _SEC 10UA
		D902	0DRGF00139A	GPP20J GULF TP DO15 600V 2.0A 70A 2.0USSEC 5.0UA
		D904	0DR100009CD	RGP10G-1021 TIWAN SEMI TP DO41 400V 1A 30A 150NSEC 5UA
		D905	0DD400709CC	UF4007-1021 TIWAN SEMI TP DO204AL 1000V 1A 30A 75NSEC 10UA
		D906	0DR100009CD	RGP10G-1021 TIWAN SEMI TP DO41 400V 1A 30A 150NSEC 5UA
		D908	0DSPT00029A	1N4148M PCTRONIX TP DO34 100V 75VA 2000MA 4NSEC 0.025UA
		D910	0DSPT00029A	1N4148M PCTRONIX TP DO34 100V 75VA 2000MA 4NSEC 0.025UA
		D911	0DSPT00029A	1N4148M PCTRONIX TP DO34 100V 75VA 2000MA 4NSEC 0.025UA
		D941	0DR400409AC	UF4004 GULF TP DO41 400V 1A 30A 50NSEC 10UA
		D942	0DR400409AC	UF4004 GULF TP DO41 400V 1A 30A 50NSEC 10UA
		D951	0DRGF00150A	UF5404 GULF BK DO201AD 400V 3.0A 150A 50NSSEC 10.0UA
		D952	0DSPT00029A	1N4148M PCTRONIX TP DO34 100V 75VA 2000MA 4NSEC 0.025UA
		D961	0DRGS00090A	31GF6L-5701 GENERAL SEMICONDUCTOR BK NON 600V 3A 60A 30NSEC 20UA
		D971	0DD400709CC	UF4007-1021 TIWAN SEMI TP DO204AL 1000V 1A 30A 75NSEC 10UA
		ZD301	0DZPT43009A	UZ-4.3BSB PCTRONIX TP DO34 500MW 4.3BV 5MA (52MMTP)PF
		ZD402	0DZPT56009A	UZ-5.6BSB PCTRONIX TP52 DO34 500MW 5.6BV 5MA PF
		ZD403	0DZPT56009A	UZ-5.6BSB PCTRONIX TP52 DO34 500MW 5.6BV 5MA PF
		ZD404	0DZPT56009A	UZ-5.6BSB PCTRONIX TP52 DO34 500MW

DATE:2004.08.08				
*S	*AL	LOC NO.	PART NO.	DESCRIPTION/SPECIFICATON
		ZD405	0DZPT56009A	5.6BV 5MA PF UZ-5.6BSB PCTRONIX TP52 DO34 500MW
		ZD406	0DZPT56009A	5.6BV 5MA PF UZ-5.6BSB PCTRONIX TP52 DO34 500MW
		ZD902	0DZPT51009A	5.6BV 5MA PF UZ-5.1BSB PCTRONIX TP DO34 500MW
				5.1BV 5MA PF
COILs&COREs				
		FB302	6210TCE003L	BAS3580T BO SUNG 3580MM AXIAL52MM
		FB305	6210TCE003P	BRS2550B BO SUNG 2550MM RADIAL
		FB306	6210TCE003L	BAS3580T BO SUNG 3580MM AXIAL52MM
		FB307	6210TCE003B	BRS3580B BO SUNG 3580MM RADIAL
		FB308	6210TCE003J	BAS2550T BO SUNG 2550MM AXIAL52MM
		FB309	6210TCE003J	BAS2550T BO SUNG 2550MM AXIAL52MM
		FB310	6210TCE003A	BRD3510B BO SUNG 3510MM RADIAL
		FB313	6210TCE003J	BAS2550T BO SUNG 2550MM AXIAL52MM
		FB701	6210TCE003L	BAS3580T BO SUNG 3580MM AXIAL52MM
		FB903	6210TCE003P	BRS2550B BO SUNG 2550MM RADIAL
		FB905	6210TCE003J	BAS2550T BO SUNG 2550MM AXIAL52MM
		FB906	6210TCE003P	BRS2550B BO SUNG 2550MM RADIAL
		FB921	6210TCE003A	BRD3510B BO SUNG 3510MM RADIAL
		FB922	6210TCE003A	BRD3510B BO SUNG 3510MM RADIAL
		L903	6210TCE003K	BAS3550T BO SUNG 3550MM AXIAL52MM
		L702	6140TBZ025D	Ò - H-SIZE,DR12*20-C6.0,150UH 700BJÓ
		L703	6140TYZ013A	ÒLX31 SAMHWA DR14*15-C5.2, 17.5T,5.6UH TÓ
		L705	6140TBZ026C	DR15*18-C9.8 100UH 0.1*30MM 40.5T D/D CHOKE
Ics				
		IC302	0IPRPNS025C	ÒLM1246DDC/NA NATIONAL SEMICONDUCTOR 24,DIP ST ONE CHIP (VIDEO+OSD)Ó
		IC303	0IPRPNS050A	LM2470TA NATIONAL SEMICONDUCTOR 9PIN TA09A ST MONOLITHIC TRIPLE 7.0NS CRT DRIVER
		IC304	0IPRPNS005A	ÒLM2480NA NATIONAL SEMICONDUCTOR 8P,DIP ST 80V TRIPLE BIAS CLAMPÓ
		IC401	0IMCRPH033A	SAA4849(OTP) PHILIPS 56PIN SDIP - DEFLECTION AND MICOM
		IC402	0IMMRSG044A	M24C08-WBN6 STM 8PIN PDIP ST SERIAL IIC EEPROM
		IC601	0IPRPPH018A	ÓTDA4867J PHILIPS 9PIN,ST DIP VERTICAL OUTPUT ICÓ
		IC901	0ISS384200A	KA3842B (PWM)
TRANSISTORs				
		Q501	0TR320209AA	KTC3202-Y(KTC1959) TP KEC TO92 NPN
		Q502	0TR127009AA	KTA1270-Y(KTA562TM) TP KEC TO92 PNP
		Q503	0TR319809AA	KTC3198-Y(KTC1815) TP KEC TO92 NPN
		Q703	0TFFC10012A	FQPF10N20C FAIRCHILD ST TO220F 200V 9.5A
		Q704	0TR390409CA	FAIRCHILD 2N3904(TA) TP TO-92 60V 0.2A
		Q705	0TR200009AB	KTC200-Y TP KEC TO92 NPN
		Q706	0TRFC10008A	FJAF5804(TU) FAIRCHILD ST TO3PF 1500V 12A
		Q710	0TRKE90020A	MPSA44 KEC TP TO92 500V 300MA
		Q711	0TF630001BB	SGS-T(STM) IRF630MFP ST TO220F 200V 5A
		Q712	0TF630001BB	SGS-T(STM) IRF630MFP ST TO220F 200V 5A
		Q713	0TF630001BB	SGS-T(STM) IRF630MFP ST TO220F 200V 5A
		Q714	0TR319809AA	KTC3198-Y(KTC1815) TP KEC TO92 NPN
		Q715	0TR319809AA	KTC3198-Y(KTC1815) TP KEC TO92 NPN
		Q716	0TR319809AA	KTC3198-Y(KTC1815) TP KEC TO92 NPN

DATE:2004.08.08				
*S	*AL	LOC NO.	PART NO.	DESCRIPTION/SPECIFICATON
		Q719	0TFFC10012A	FQPF10N20C FAIRCHILD ST TO220F 200V 9.5A
		Q720	0TR390409CA	FAIRCHILD 2N3904(TA) TP TO-92 60V 0.2A
		Q799	0TRKE90019A	MPSA92 KEC TP TO92 -300V -500MA
		Q901	0TF760000AD	SSS7N60B FAIRCHILD ST TO220F 650V 7A
		Q903	0TR100809AA	KSC1008C-Y TP SAMSUNG TO92 NPN
		Q941	0TR319809AA	KTC3198-Y(KTC1815) TP KEC TO92 NPN
		Q942	0TR127309AA	KTA1273-Y(KTA966A) TP KEC TO92L PNP
		Q951	0TR319809AA	KTC3198-Y(KTC1815) TP KEC TO92 NPN
		Q952	0TR127309AA	KTA1273-Y(KTA966A) TP KEC TO92L PNP
		Q953	0TR319809AA	KTC3198-Y(KTC1815) TP KEC TO92 NPN
RESISTORs				
		R201	0RD1001Q609	1K 1/4W(3 5% TA52
		R202	0RD0912Q609	91 OHM 1/4 W (3.4) 5% TA52
		R203	0RD2200Q609	220 1/4W(3 5% TA52
		R204	0RD4300Q609	430 OHM 1/4 W(3.4) 5.00% TA52
		R205	0RD1001Q609	1K 1/4W(3 5% TA52
		R206	0RD0912Q609	91 OHM 1/4 W (3.4) 5% TA52
		R207	0RD4300Q609	430 OHM 1/4 W(3.4) 5.00% TA52
		R208	0RD2200Q609	220 1/4W(3 5% TA52
		R209	0RD9100Q609	910 1/4W(3 5% TA52
		R211	0RD2200Q609	220 1/4W(3 5% TA52
		R301	0RD0752Q609	75 1/4W(3 5% TA52
		R302	0RD0752Q609	75 1/4W(3 5% TA52
		R303	0RD0752Q609	75 1/4W(3 5% TA52
		R305	0RN6201F409	6.20K 1/6W 1% TA52
		R314	0RD1000Q609	100 1/4W(3 5% TA52
		R315	0RD1000Q609	100 1/4W(3 5% TA52
		R319	0RD4701Q609	4.70K 1/4W(3 5% TA52
		R320	0RD4701Q609	4.70K 1/4W(3 5% TA52
		R326	0RD2201Q609	2.20K 1/4W(3 5% TA52
		R327	0RD1001Q609	1K 1/4W(3 5% TA52
		R328	0RD1001Q609	1K 1/4W(3 5% TA52
		R329	0RD1001Q609	1K 1/4W(3 5% TA52
		R330	0RD1001Q609	1K 1/4W(3 5% TA52
		R331	0RD1600Q609	160 1/4W(3 5% TA52
		R332	0RD1600Q609	160 1/4W(3 5% TA52
		R333	0RD1300Q609	130 1/4W(3 5% TA52
		R334	0RD3303Q609	330K 1/4W(3 5% TA52
		R335	0RD3303Q609	330K 1/4W(3 5% TA52
		R336	0RD3303Q609	330K 1/4W(3 5% TA52
		R337	0RD1000Q609	100 1/4W(3 5% TA52
		R338	0RD0102Q609	10 1/4W(3 5% TA52
		R340	0RN1002F409	10K 1/6W 1 TA52
		R341	0RD0332A609	33 OHM 1/2 W (7.0) 5% TA52
		R342	0RD0332A609	33 OHM 1/2 W (7.0) 5% TA52
		R343	0RD0332A609	33 OHM 1/2 W (7.0) 5% TA52
		R344	0RD0332Q609	33 1/4W(3 5% TA52
		R345	0RD0332Q609	33 1/4W(3 5% TA52
		R346	0RD0332Q609	33 1/4W(3 5% TA52
		R347	0RD0202Q609	20 1/4W(3 5% TA52
		R401	0RD2200Q609	220 1/4W(3 5% TA52
		R402	0RD1000Q609	100 1/4W(3 5% TA52
		R403	0RD1000Q609	100 1/4W(3 5% TA52
		R404	0RD1000Q609	100 1/4W(3 5% TA52
		R405	0RD2201Q609	2.20K 1/4W(3 5% TA52
		R406	0RD2201Q609	2.20K 1/4W(3 5% TA52
		R407	0RD4701Q609	4.70K 1/4W(3 5% TA52
		R408	0RD1000Q609	100 1/4W(3 5% TA52
		R409	0RD1000Q609	100 1/4W(3 5% TA52
		R411	0RD1000Q609	100 1/4W(3 5% TA52
		R412	0RD1000Q609	100 1/4W(3 5% TA52
		R413	0RD1000Q609	100 1/4W(3 5% TA52

DATE:2004.08.08				
*S	*AL	LOC NO.	PART NO.	DESCRIPTION/SPECIFICATON
		R414	ORD1602Q609	16K 1/4W(3 5% TA52
		R415	ORD1000Q609	100 1/4W(3 5% TA52
△		R416	ORN1501F409	1.5K 1/6W 1 TA52
		R417	ORD1000Q609	100 1/4W(3 5% TA52
		R419	ORN4702F409	47K 1/6W 1% TA52
		R420	ORD2001Q609	2K 1/4W(3 5% TA52
		R421	ORD1501Q609	1.50K 1/4W(3 5% TA52
		R422	ORD2001Q609	2K 1/4W(3 5% TA52
		R423	ORD1000Q609	100 1/4W(3 5% TA52
		R424	ORD1000Q609	100 1/4W(3 5% TA52
		R425	ORD1000Q609	100 1/4W(3 5% TA52
		R426	ORD1000Q609	100 1/4W(3 5% TA52
		R427	ORD1002Q609	10K 1/4W(3 5% TA52
		R429	ORD1002Q609	10K 1/4W(3 5% TA52
		R430	ORD1000Q609	100 1/4W(3 5% TA52
		R431	ORD1802Q609	18K 1/4W(3 5% TA52
		R432	ORD2001Q609	2K 1/4W(3 5% TA52
		R434	ORD1503Q609	150K 1/4W(3 5% TA52
		R436	ORD3601Q609	3.60K 1/4W(3 5% TA52
△		R437	ORN2702F409	27K 1/6W 1% TA52
		R438	ORD1303Q609	130K 1/4W(3 5% TA52
△		R439	ORN4700F409	470 1/6W 1 TA52
△		R440	ORN1001F409	1K 1/6W 1% TA52
		R441	ORD6802Q609	68K 1/4W(3 5% TA52
		R442	ORN3901F409	3.90K 1/6W 1% TA52
		R443	ORD2200Q609	220 1/4W(3 5% TA52
		R444	ORD4700Q609	470 OHM 1/4 W (3.4) 5% TA52
		R445	ORD4700Q609	470 OHM 1/4 W (3.4) 5% TA52
		R446	ORD1000Q609	100 1/4W(3 5% TA52
		R447	ORD1000Q609	100 1/4W(3 5% TA52
		R449	ORN7501F409	7.50K 1/6W 1% TA52
		R450	ORD1203Q509	120K OHM 1/4 W (3.4) 2% TA52
		R451	ORD1001Q609	1K 1/4W(3 5% TA52
		R452	ORD6201Q609	6.20K 1/4W (3 5% TA52 (T710BL)
		R452	ORD2002Q609	20K 1/4W(3 5% TA52 (T710BHL)
		R453	ORD2001Q609	2K 1/4W(3 5% TA52
		R454	ORD2001Q609	2K 1/4W(3 5% TA52
		R455	ORD1002Q609	10K 1/4W(3 5% TA52
		R456	ORD1000Q609	100 1/4W(3 5% TA52
		R461	ORD3900Q609	390 1/4W(3 5% TA52
		R462	ORD2001Q609	2K 1/4W(3 5% TA52
		R463	ORD4701Q609	4.70K 1/4W(3 5% TA52
		R464	ORD3001Q609	3K 1/4W(3 5% TA52
		R501	ORD0102A609	10 OHM 1/2 W (7.0) 5% TA52
		R502	ORD8202Q609	82K 1/4W(3 5% TA52
		R503	ORD1502Q609	15K 1/4W(3 5% TA52
		R598	ORD2001Q609	2K 1/4W(3 5% TA52
		R601	ORD1000Q609	100 1/4W(3 5% TA52
		R602	ORD1000Q609	100 1/4W(3 5% TA52
		R603	ORN0220H609	0.22 1/2W 5% TA52
		R604	ORD0101A609	1 OHM 1/2 W (7.0) 5% TA52
		R605	ORD0102A609	10 OHM 1/2 W (7.0) 5% TA52
		R606	ORD4700Q609	470 OHM 1/4 W (3.4) 5% TA52
		R607	ORN4301F409	4.30K 1/6W 1% TA52
		R608	ORD5600A609	560 OHM 1/2 W (7.0) 5% TA52
		R701	ORD4700Q609	470 OHM 1/4 W (3.4) 5% TA52
		R702	ORD6200Q609	620 1/4W(3 5% TA52
		R703	ORD5601Q609	5.60K 1/4W(3 5% TA52
		R704	ORD1002Q609	10K 1/4W(3 5% TA52
		R705	ORD0102Q609	10 1/4W(3 5% TA52
		R706	ORD3302A609	33K OHM 1/2 W (7.0) 5% TA52
		R727	ORX0272K665	27 OHM 2 W 5% SF
		R728	ORD1001Q609	1K 1/4W(3 5% TA52
		R729	ORD1002Q609	10K 1/4W(3 5% TA52
		R736	ORX2201J609	2.2KOHM 1 W 5% TA52

DATE:2004.08.08				
*S	*AL	LOC NO.	PART NO.	DESCRIPTION/SPECIFICATON
		R739	ORD2701Q609	2.70K 1/4W(3 5% TA52
		R740	ORD0271A609	2.7 OHM 1/2 W (7.0) 5% TA52
		R744	ORD1001A609	1K OHM 1/2 W (7.0) 5% TA52
		R745	ORD4702Q609	47K 1/4W(3 5% TA52
		R746	ORD2201Q609	2.20K 1/4W(3 5% TA52
		R747	ORD3001Q609	3K 1/4W(3 5% TA52
		R748	ORD4702Q609	47K 1/4W(3 5% TA52
		R749	ORD2201Q609	2.20K 1/4W(3 5% TA52
		R750	ORD3001Q609	3K 1/4W(3 5% TA52
		R751	ORD0222A609	22 OHM 1/2 W (7.0) 5% TA52
		R752	ORD2201Q609	2.20K 1/4W(3 5% TA52
		R753	ORD3001Q609	3K 1/4W(3 5% TA52
		R754	ORD6800A609	680 OHM 1/2 W (7.0) 5% TA52
		R756	ORD2202A609	22K OHM 1/2 W (7.0) 5% TA52
		R761	ORD3001Q609	3K 1/4W(3 5% TA52
		R762	ORD3001Q609	3K 1/4W(3 5% TA52
		R763	ORD3001Q609	3K 1/4W(3 5% TA52
		R765	ORD3000A609	300 OHM 1/2 W (7.0) 5% TA52
		R768	ORD4703A609	470K OHM 1/2 W (7.0) 5% TA52
		R771	ORD3001Q609	3K 1/4W(3 5% TA52
		R772	ORD1202Q509	12K OHM 1/4 W (3.4) 2% TA52
		R773	ORD6202A609	62K OHM 1/2 W (7.0) 5% TA52
		R782	ORD3301A609	3.3K OHM 1/2 W(7.0) 5.00% TA52
		R793	ORD4702Q609	47K 1/4W(3 5% TA52
		R797	ORD1501Q609	1.50K 1/4W(3 5% TA52
		R798	ORD2001Q609	2K 1/4W(3 5% TA52
		R799	ORD1502Q609	15K 1/4W(3 5% TA52
		R801	ORD1502Q609	15K 1/4W(3 5% TA52
		R802	ORD1502Q609	15K 1/4W(3 5% TA52
		R803	ORD1001Q609	1K 1/4W(3 5% TA52
		R809	ORX0101K665	1 OHM 2 W 5% SF
△		R818	ORN6202F409	62KOHM 1/6 W 1% TA52
		R901	ORD4703A609	470K OHM 1/2 W (7.0) 5% TA52
		R902	ORD0332Q609	33 1/4W(3 5% TA52
		R903	ORN0562F409	56 OHM 1/6 W 1% TA52
		R904	ORX3902K665	39K OHM 2 W 5% SF
		R906	ORD6200Q609	620 1/4W(3 5% TA52
		R907	ORD3902Q609	39K 1/4W(3 5% TA52
		R910	ORX4702J609	47K OHM 1 W 5% TA52
		R911	ORD0202Q609	20 1/4W(3 5% TA52
		R912	ORN1802F409	18K 1/6W 1% TA52
		R913	ORN2701F409	2.7K OHM 1/6 W 1.00% TA52
		R915	ORD2000Q609	200 1/4W(3 5% TA52
		R916	ORD1002Q609	10K 1/4W(3 5% TA52
		R918	ORD1001Q609	1K 1/4W(3 5% TA52
		R923	ORD1003Q609	100K 1/4W(3 5% TA52
		R924	ORN0390H609	0.39 1/2W 5 TA52
		R925	ORN0390H609	0.39 1/2W 5 TA52
		R926	ORD4301Q609	4.30K 1/4W(3 5% TA52
		R927	ORD2002Q609	20K 1/4W(3 5% TA52
		R928	ORD1800Q609	180 1/4W(3 5% TA52
		R929	ORD0332Q609	33 1/4W(3 5% TA52
		R941	ORN0220H609	0.22 1/2W 5% TA52
		R944	ORD4700A609	470 OHM 1/2 W (7.0) 5% TA52
		R945	ORD4701Q609	4.70K 1/4W(3 5% TA52
		R952	ORD1202A609	12K OHM 1/2 W(7.0) 5.00% TA52
		R953	ORD1001A609	1K OHM 1/2 W (7.0) 5% TA52
		R954	ORD4701Q609	4.70K 1/4W(3 5% TA52
		R955	ORD4701Q609	4.70K 1/4W(3 5% TA52
		R956	ORD6802A609	68K OHM 1/2 W (7.0) 5% TA52
		R957	ORD0472A609	47 OHM 1/2 W (7.0) 5% TA52
		R960	ORD6200A609	620 OHM 1/2 W(7.0) 5.00% TA52
		OTHERS		
		RL901	6920TBB007A	JZC-42012-2HS HONGMEI 250VAC 5A 12V 2A NO VENTING





SCHEMATIC DIAGRAM

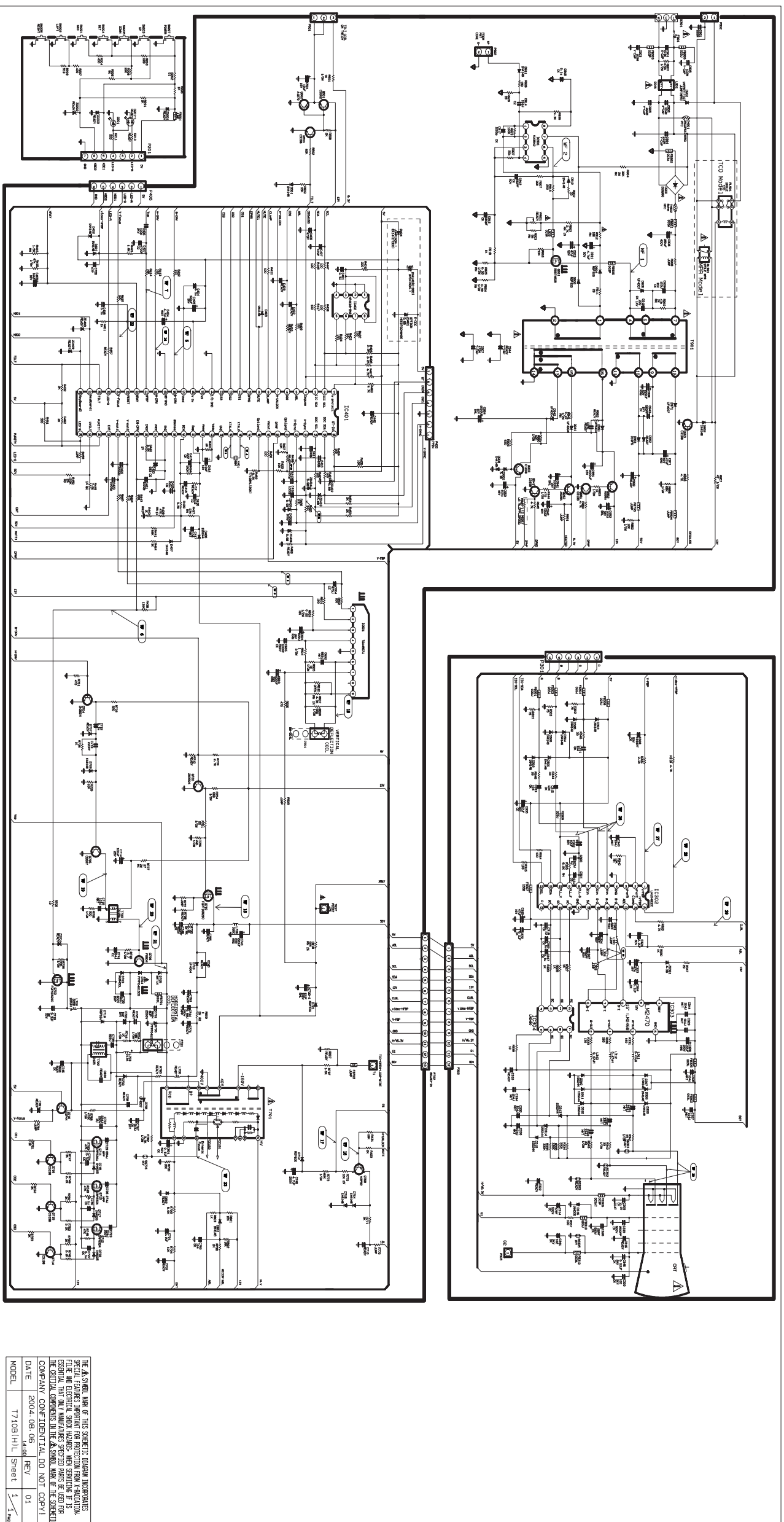

THE ABOVE DRAWING IS THE SPECIFIC DESIGN AND/OR PARTS LIST. SPECIAL FEATURES APPEAR FOR PROTECTION FROM REPRODUCTION. THESE FEATURES ARE SHOWN IN RED. THE ORIGINAL DRAWING IS THE SPECIFIC COMPANY CONFIDENTIAL. DO NOT COPY!  
 DATE: 2004.08.06 REV: 01  
 MODEL: T710B(H)IL Sheet 1 of 1

**NOTICE**  
 Since this is a basic schematic diagram,  
 The value of components and some partial connection are  
 subject to be changed for improvement without notice.

01	Q901, Drain	02	IC901, #6	03	IC401, #8	04	IC401, #9	05	IC801, #6	06	IC801, #11	07		08	IC801, #13	09	IC801, #12	10	IC801, #15
11	IC801, #14	14	IC801, #8	15	IC601, #6	16	IC601, #8	17	Q833, Drain	18	Q832, Drain	19	Q801, Base	20	Q801, Collector	21	IC802, #3	22	
23	Q704, Gate	26	IC305, #5, 6, 7	27	IC302, #1	28	IC302, #24	29	IC302, #23	30	IC302, #19, 20, 21	31	CDT, R.K, G.K, B.K						

PRINTED CIRCUIT BOARD

1. CONTROL BOARD (Component Side)

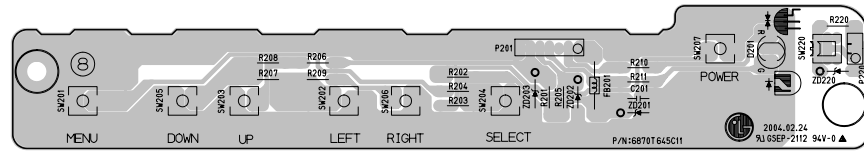

2. CONTROL BOARD (Solder Side)

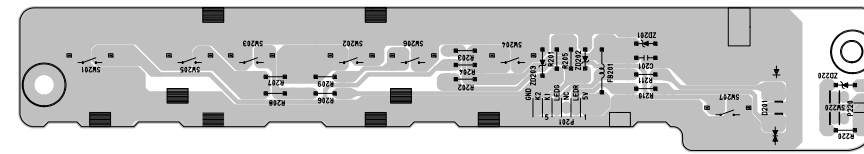

3. MAIN BOARD (Component Side)

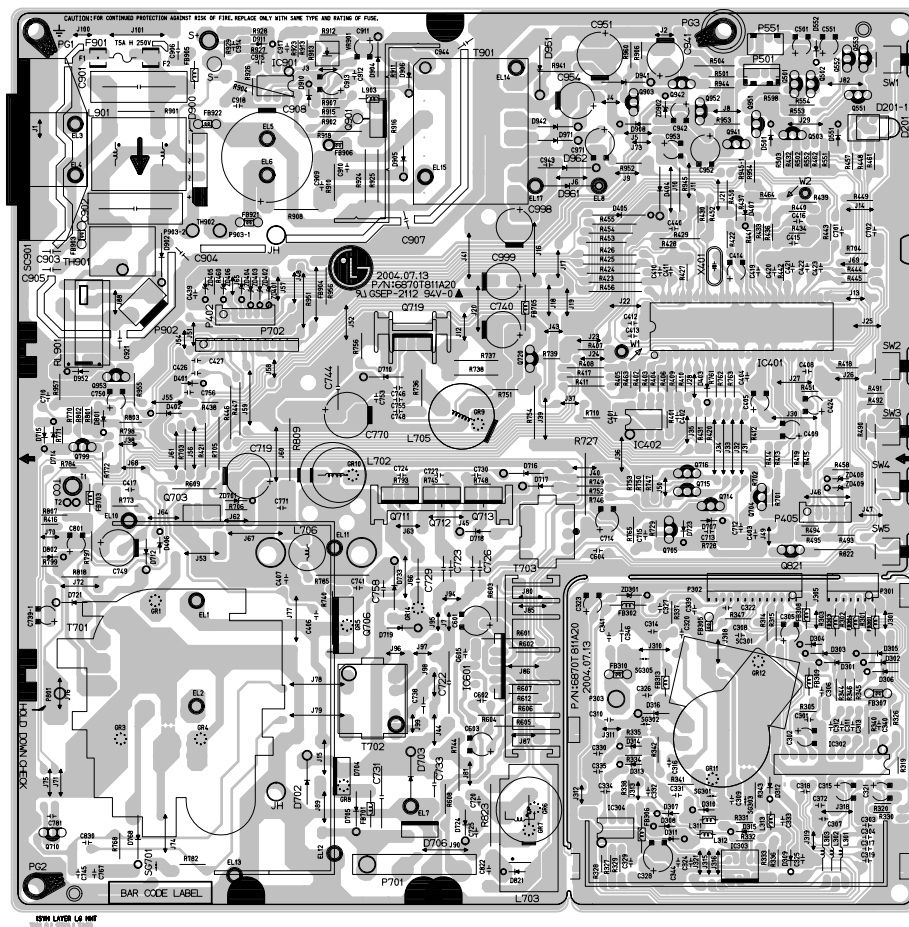

4. MAIN BOARD (Solder Side)

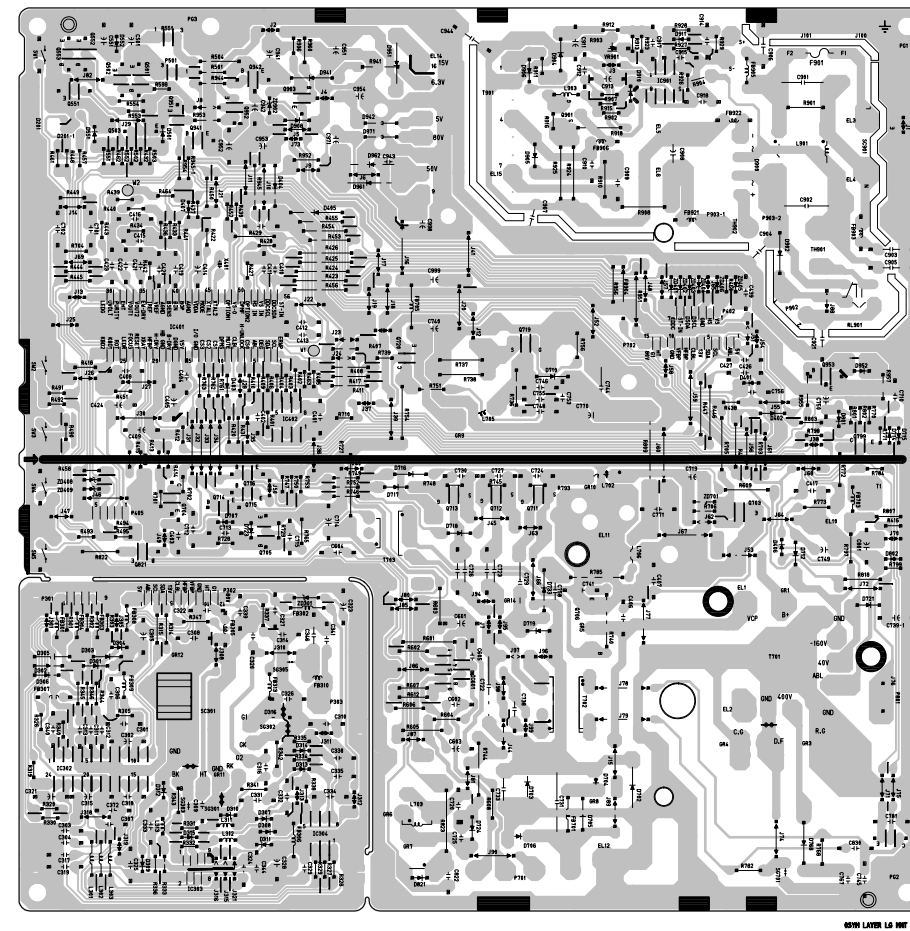



P/NO : 3828TSL105C

Jul. 2004  
Printed in China

