

MK4

MK6

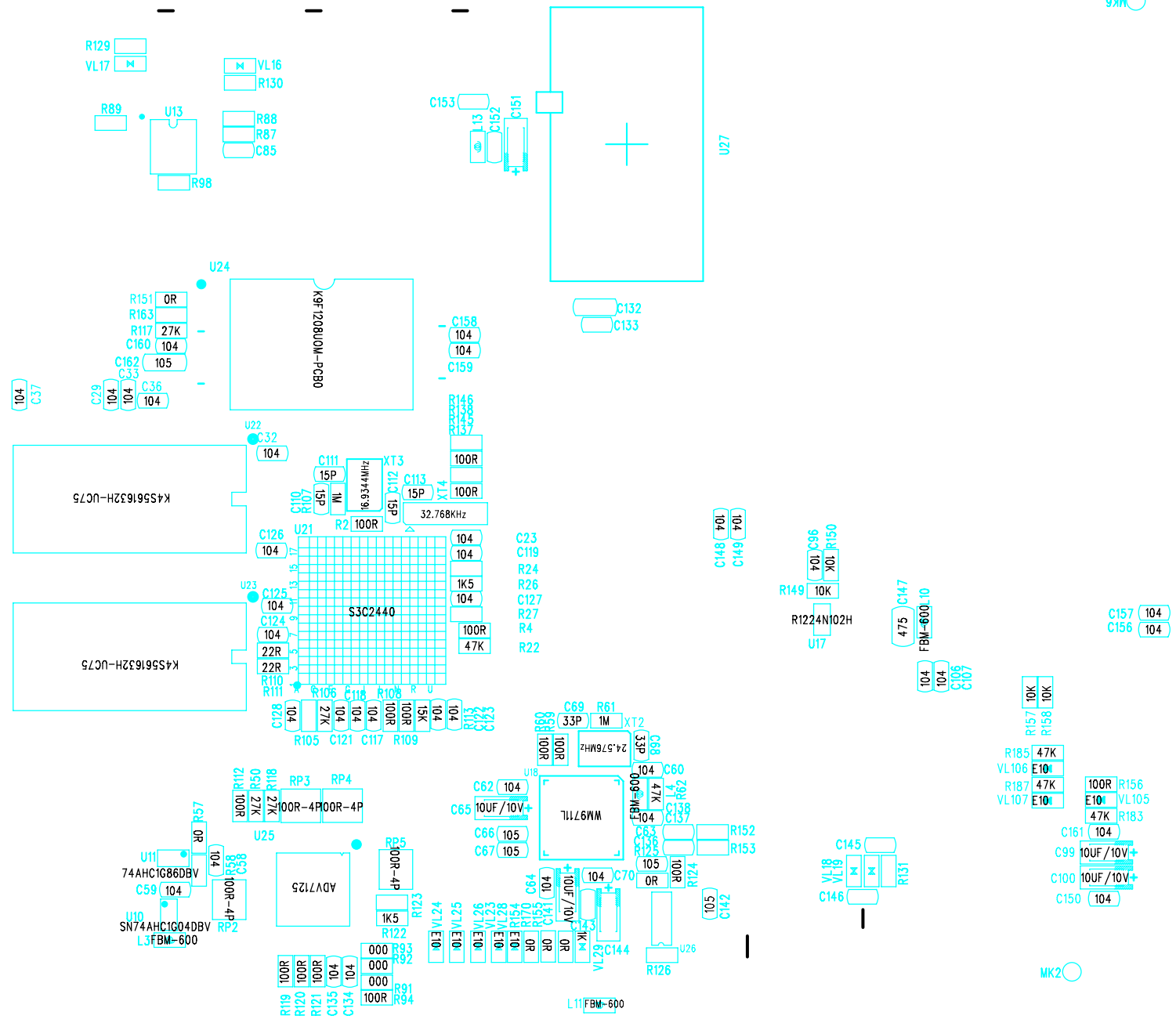

MK2

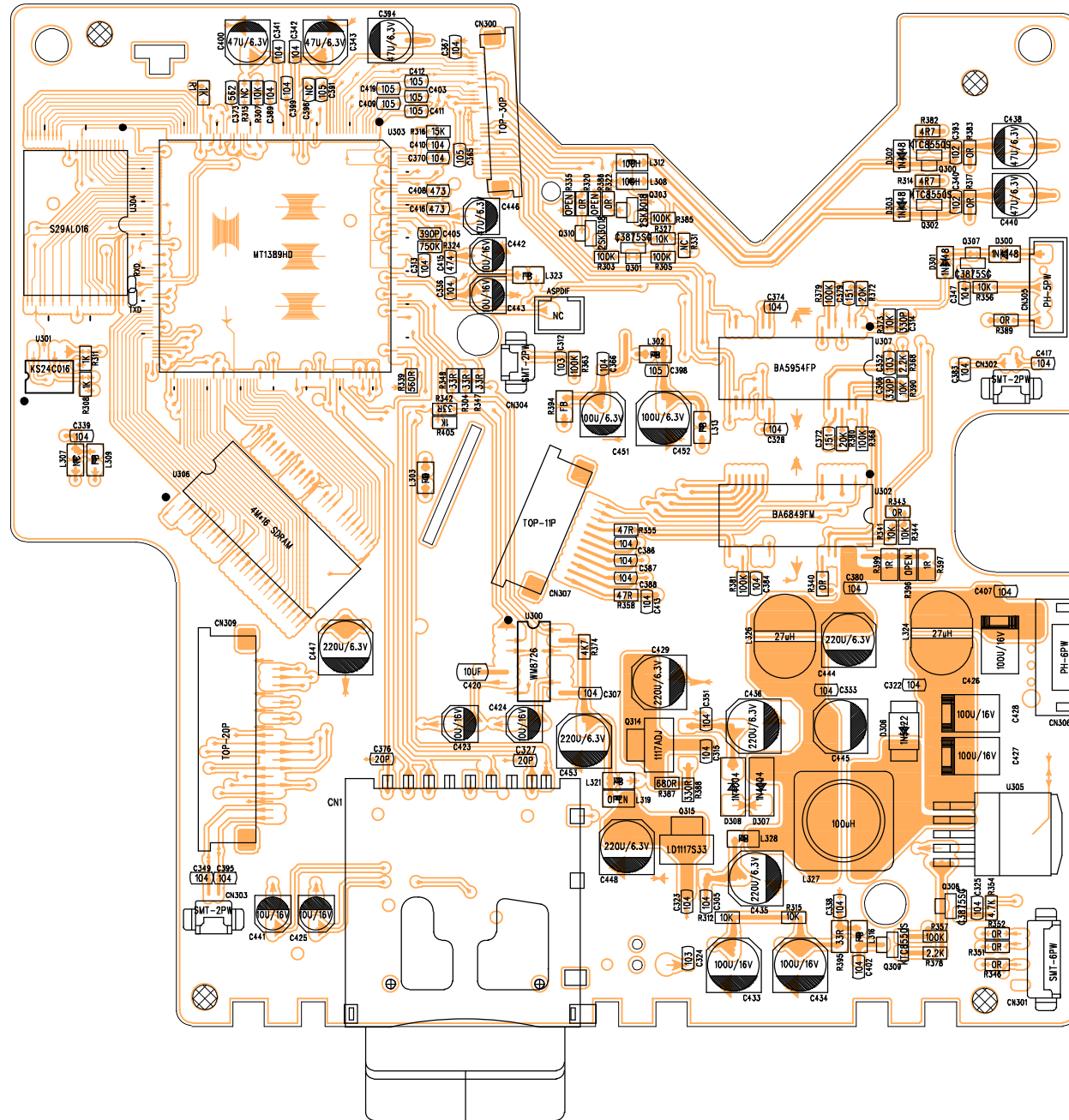

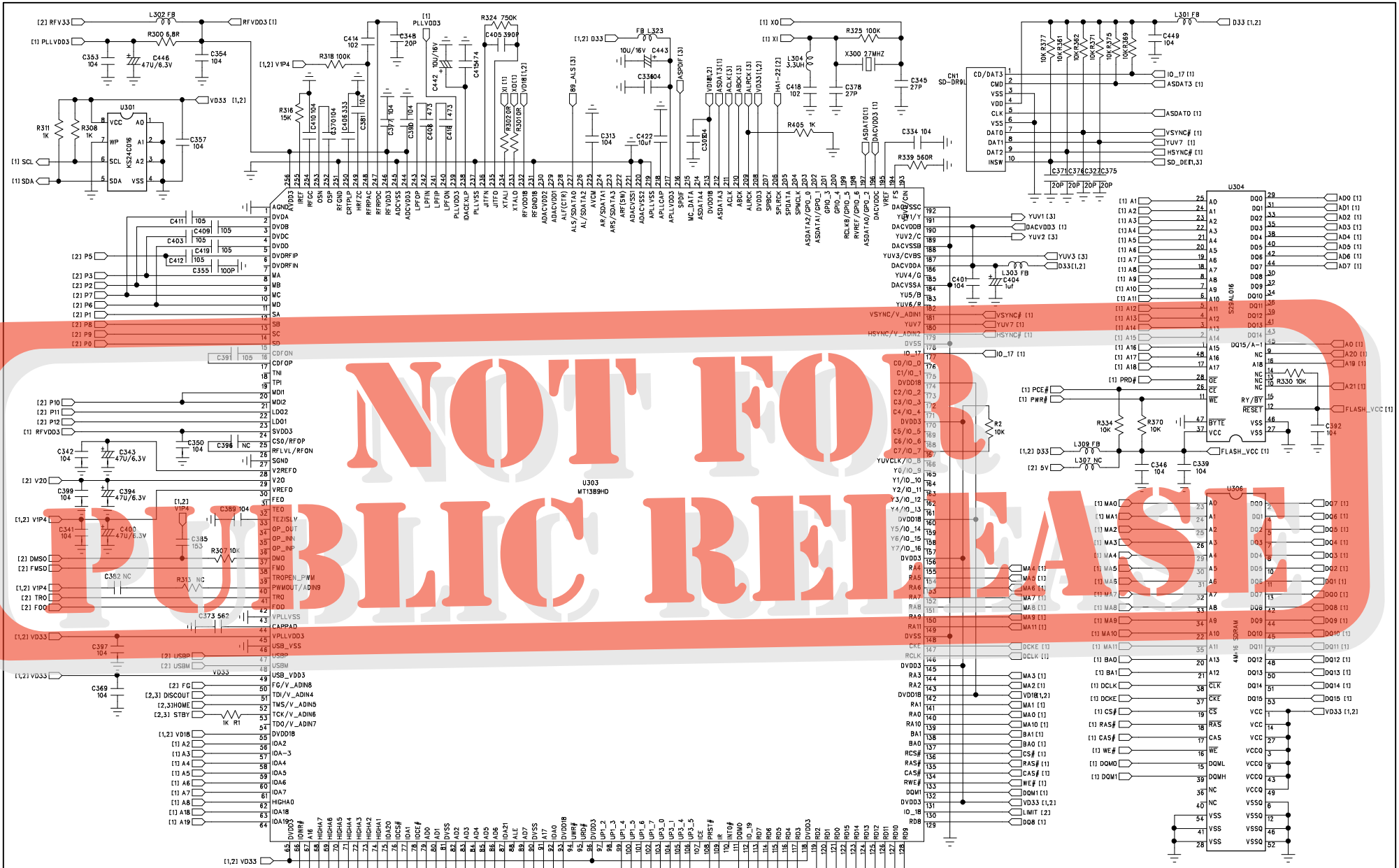

HuiZhou FREEWAY Electronic Limited					
MODEL:	FILE NAME:				
	FILE NO:				
PART NO:	DRN./DATE:	REV:	UPDATE:	REV:	UPDATE:
PART NAME:	CHK./DATE:	01		03	
DRAWING NO:	APP./DATE:	02		04	

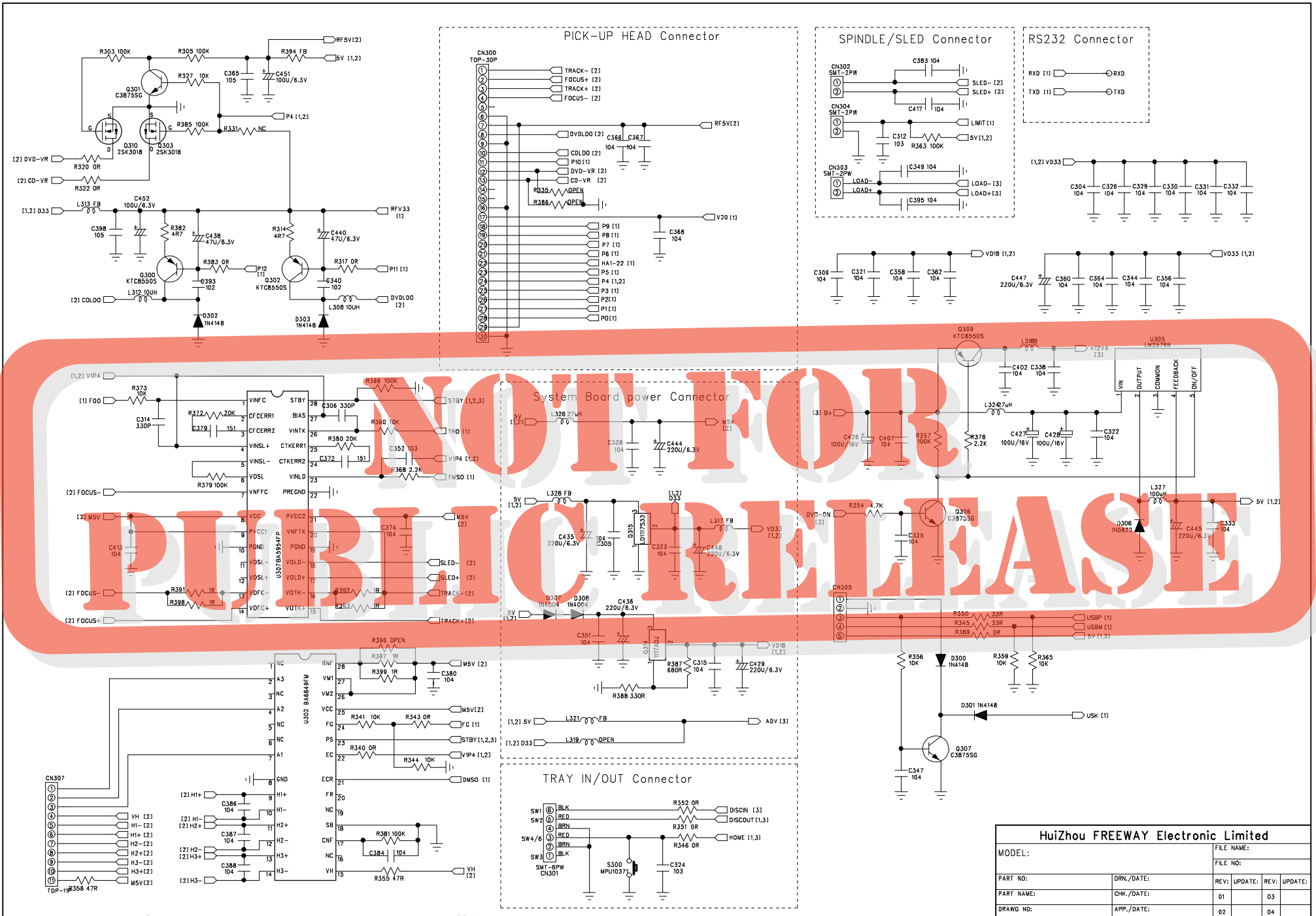

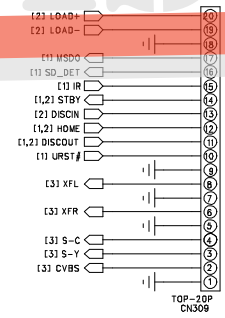
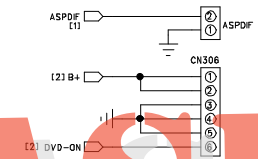
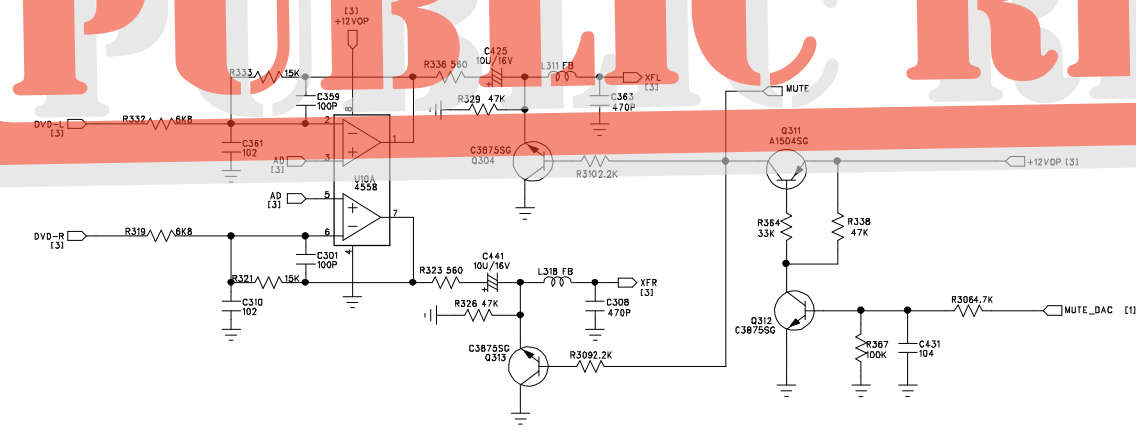
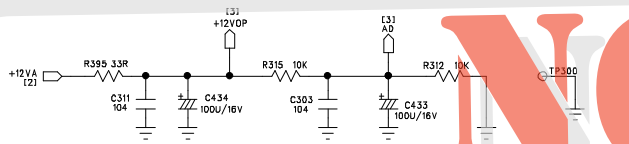
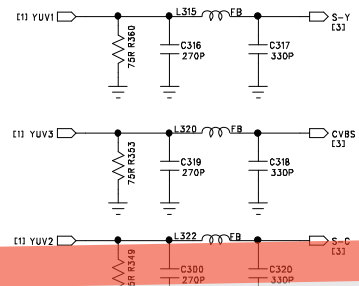
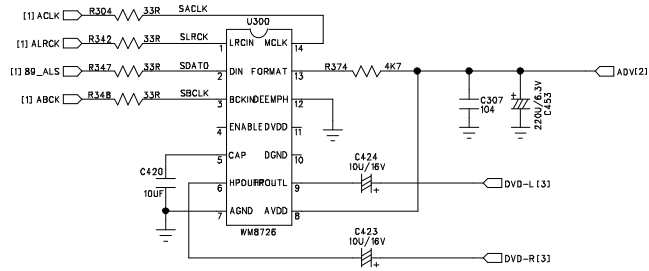

NOT FOR PUBLIC RELEASE

HuiZhou FREEWAY Electronic Limited				
MODEL:		FILE NAME:		
		FILE NO:		
PART NO:	DRN./DATE:	REV:	UPDATE:	REV: UPDATE:
PART NAME:	CHK./DATE:	01		03
DRAWG NO:	APP./DATE:	02		04

NOT FOR PUBLIC RELEASE

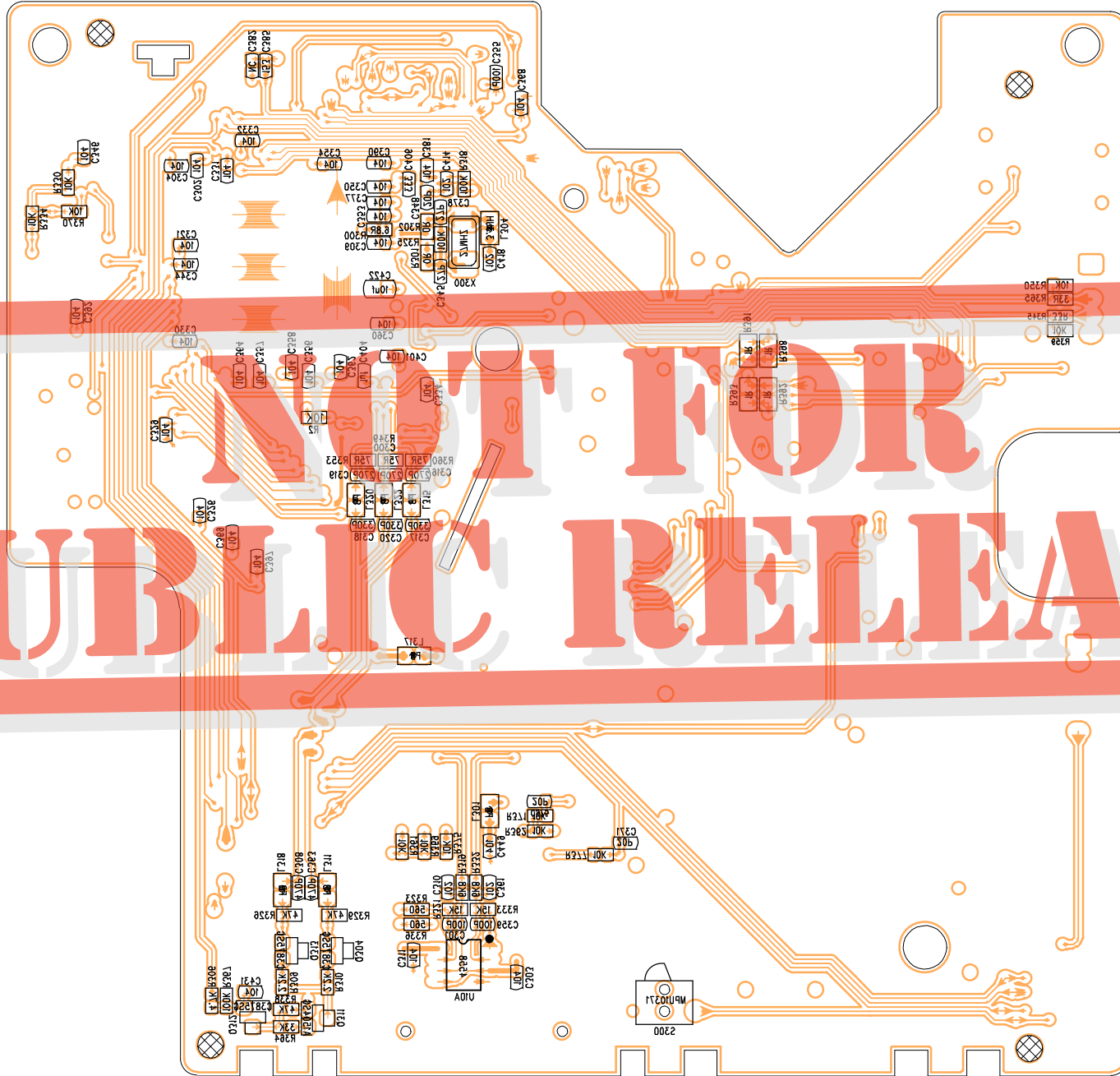

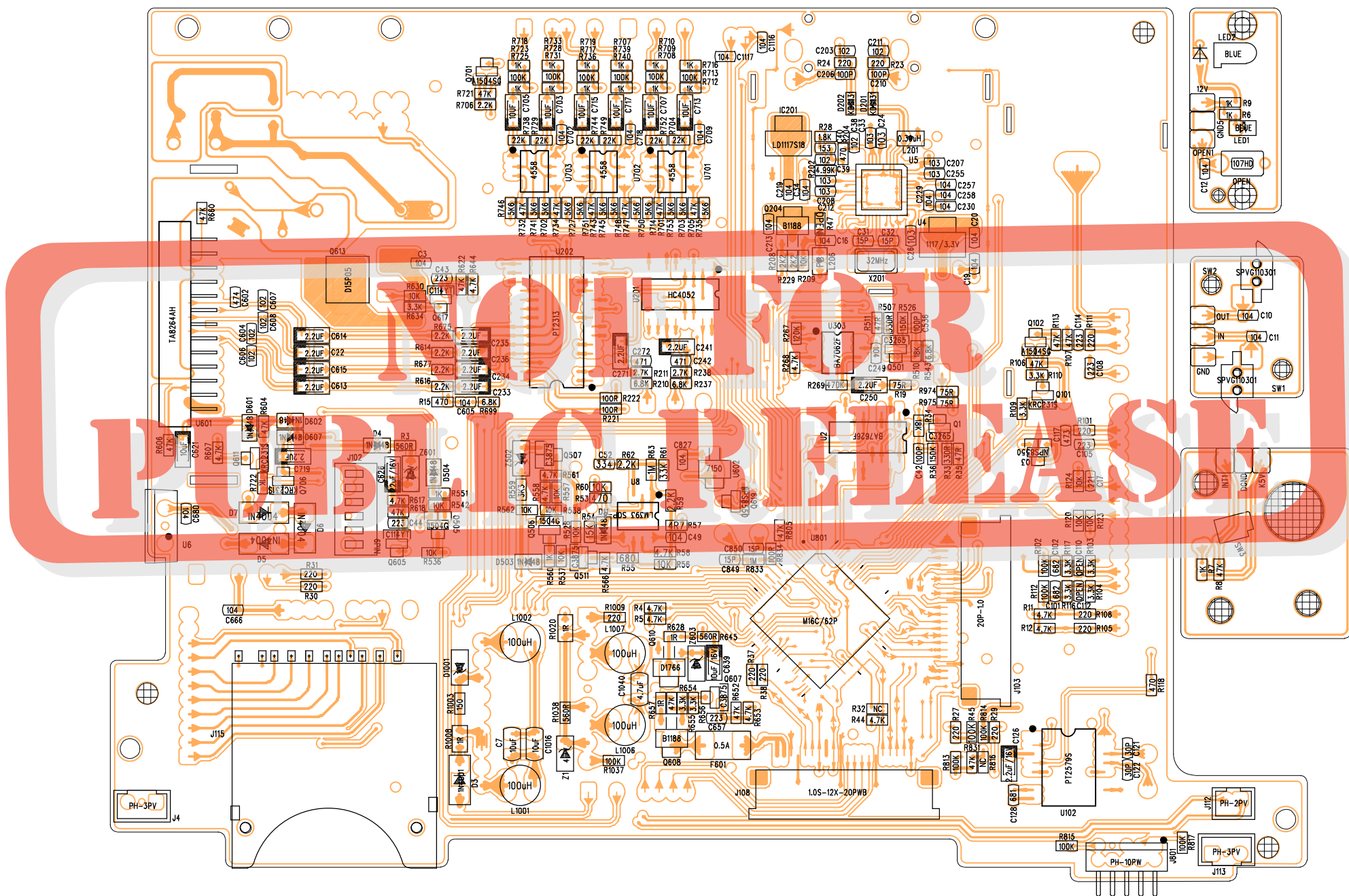

目录

图 名	页次
1-MENU	PAGE1
2-MCU	PAGE2
3-AUDIO-AMP-1	PAGE3
4-AUDIO-AMP-2	PAGE4
5-POWER&SUPPLY	PAGE5
6-RADIO/RDS_TC-510	PAGE6
7-TV TUNER	PAGE7
8-VIDEO&SWITCH	PAGE8
9-CONNECT	PAGE9
10-GPS&DVDCHG	PAGE10
11-TFT_CONNECT	PAGE11

修改记录

版本	日期	作者	说明
V1.0	2005.12.21		

声明：本设计为惠州天缘电子有限公司所有。未经本公司书面同意，任何人或企业不得对本设计全部或部分内容以任何形式进行发布、拷贝或修改。

HuiZhou FREEWAY Electronic Limited					
MODEL: KOALA_GPS		FILE NAME:			
		FILE NO:			
PART NO:	DRN./DATE: 2005.12.21	REV:	UPDATE:	REV:	UPDATE:
PART NAME: MENU	CHK./DATE:	01	V1.0	03	
DRAWG NO:	APP./DATE:	02		04	

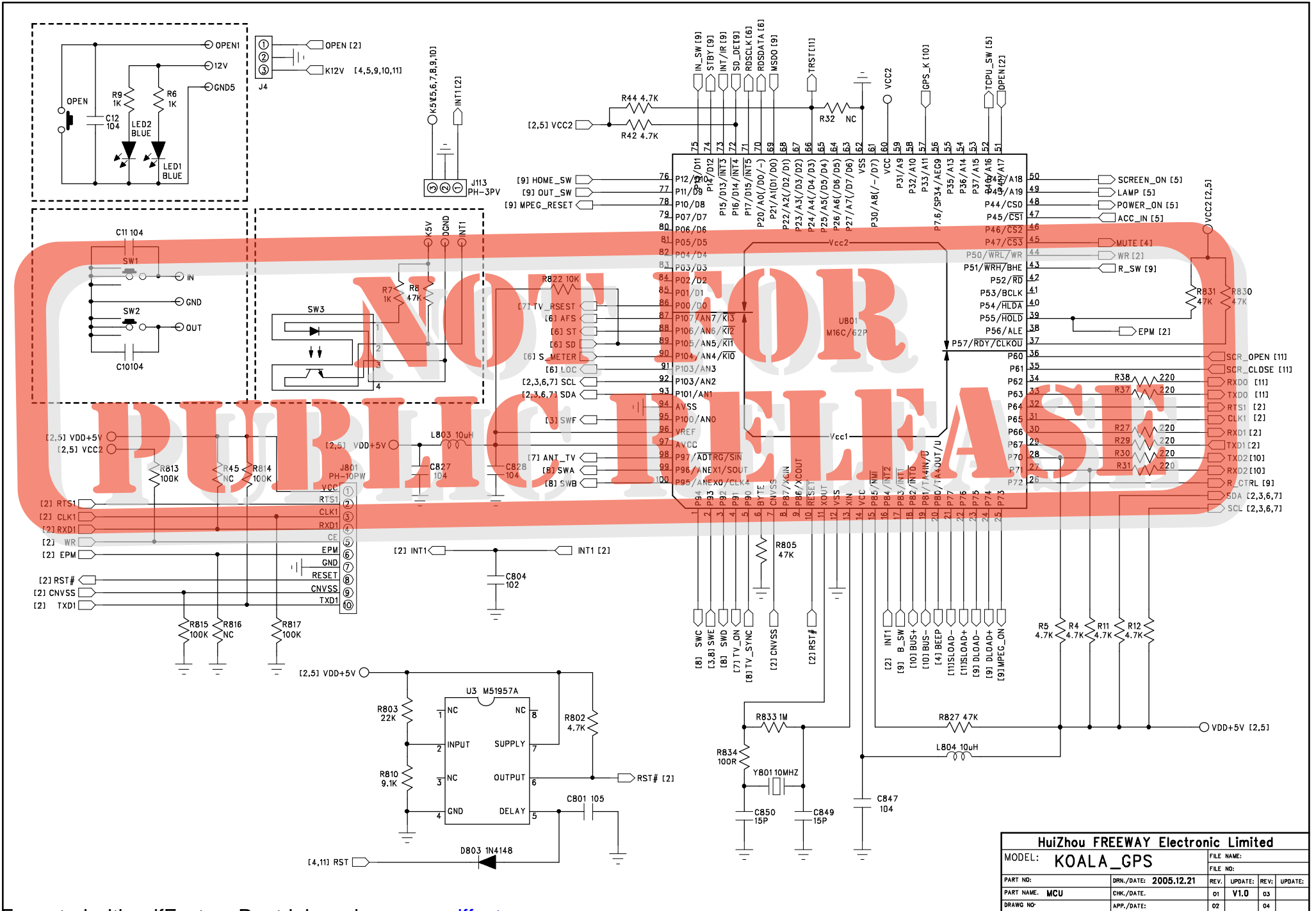

HuiZhou FREEWAY Electronic Limited			
MODEL:	KOALA_GPS	FILE NAME:	
PART NO:		REV. NO:	
PART NAME:	MCU	DRN./DATE:	2005.12.21
DRAWG NO:		CHK./DATE:	01 V1.0 03
		APP./DATE:	02 V1.0 04

OUT	SWE	SWF
MPEG	0	0
TV	1	0
DVD_CH	0	1
AV	1	1

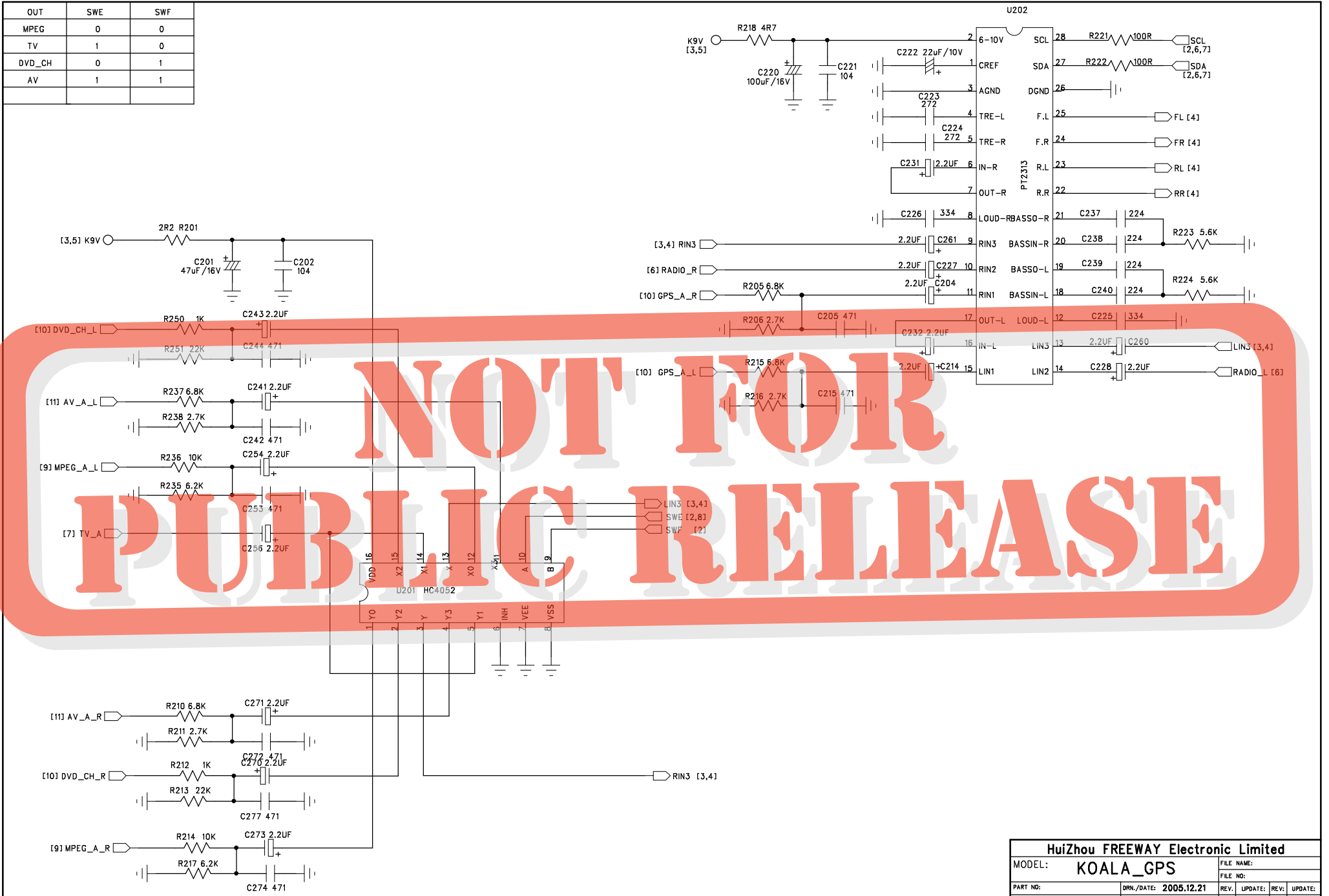

HuiZhou FREEWAY Electronic Limited			
MODEL:	KOALA_GPS	FILE NAME:	
PART NO:		FILE NO:	
PART NAME: AUDIO_AMP-1	CHK./DATE:	REV:	UPDATE:
DRAWG NO:	APP./DATE:	01	V1.0 03
		02	04

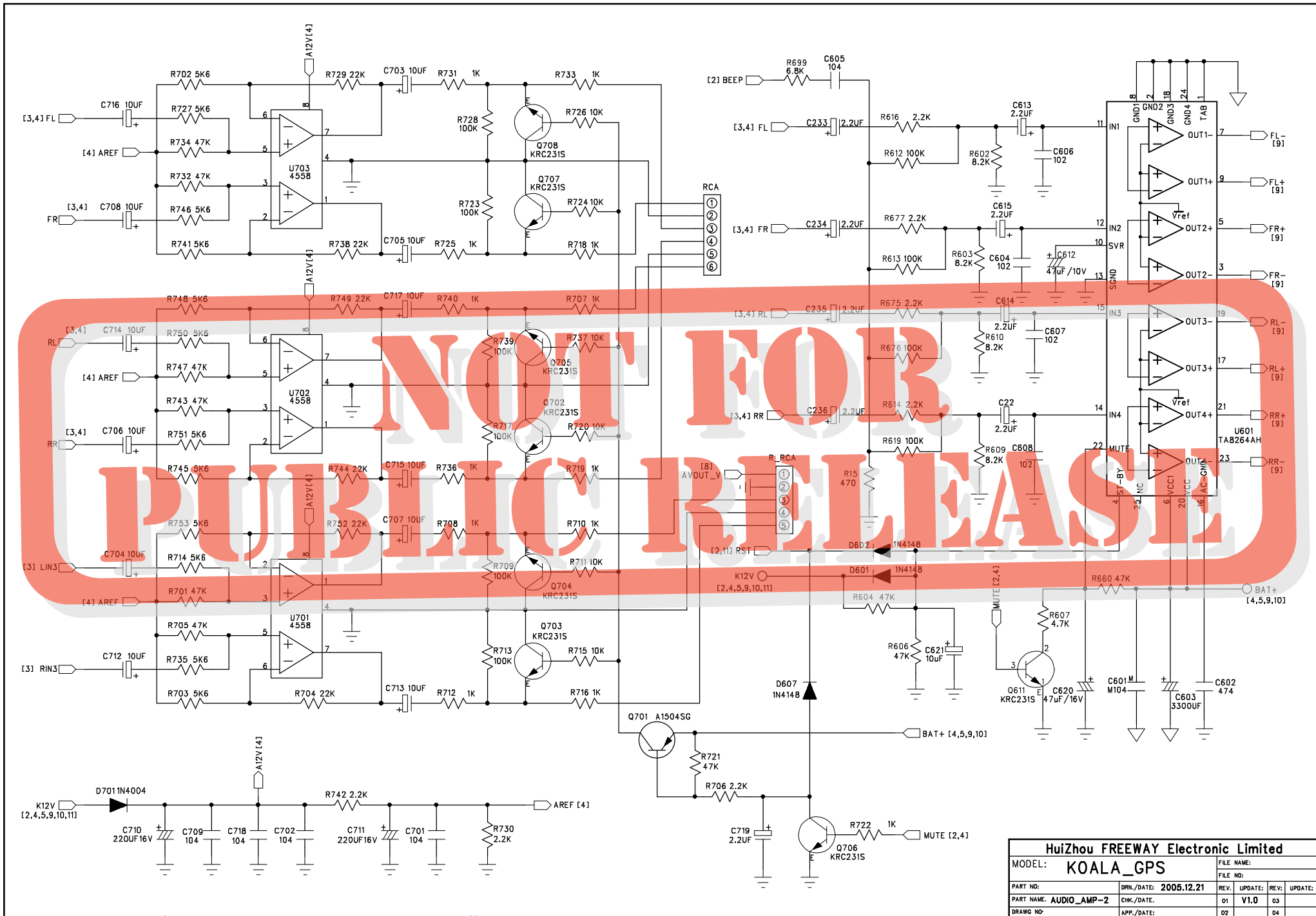

HuiZhou FREEWAY Electronic Limited			
MODEL:	KOALA_GPS		FILE NAME:
PART NO:	DRN./DATE:	2005.12.21	FILE NO:
PART NAME: AUDIO_AMP-2	CHK./DATE:		REV. UPDATE: REV. UPDATE:
DRAWG NO:	APP./DATE:		01 V1.0 03
			02 04

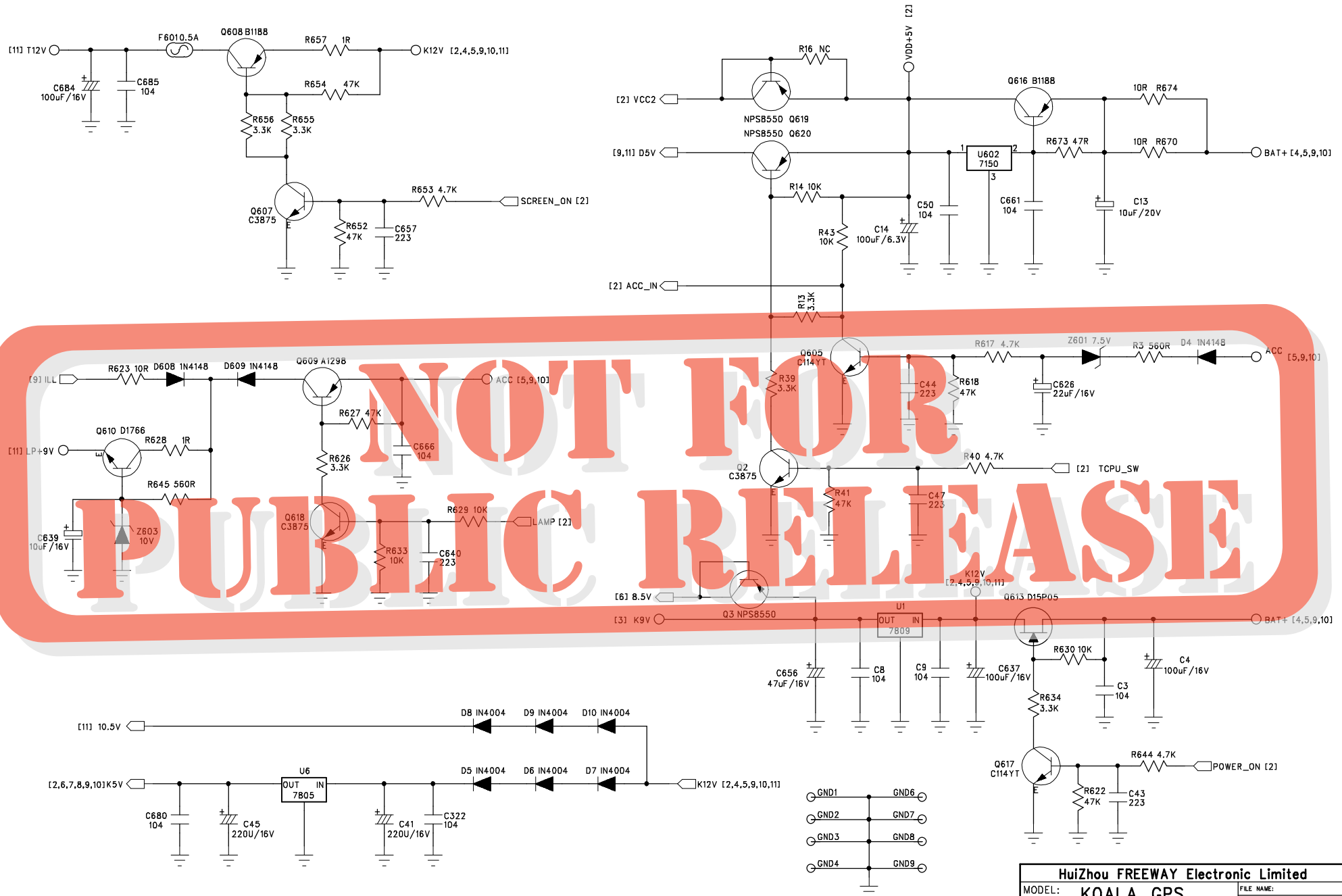

NOT FOR PUBLIC RELEASE

HuiZhou FREEWAY Electronic Limited			
MODEL: KOALA_GPS		FILE NAME:	
PART NO:		FILE NO:	
PART NAME: POWERSUPPLY		DRN./DATE: 2005.12.21	REV. UPDATE: REV. UPDATE:
DRAWG NO:		01 V1.0 03	02 04
		APP./DATE:	

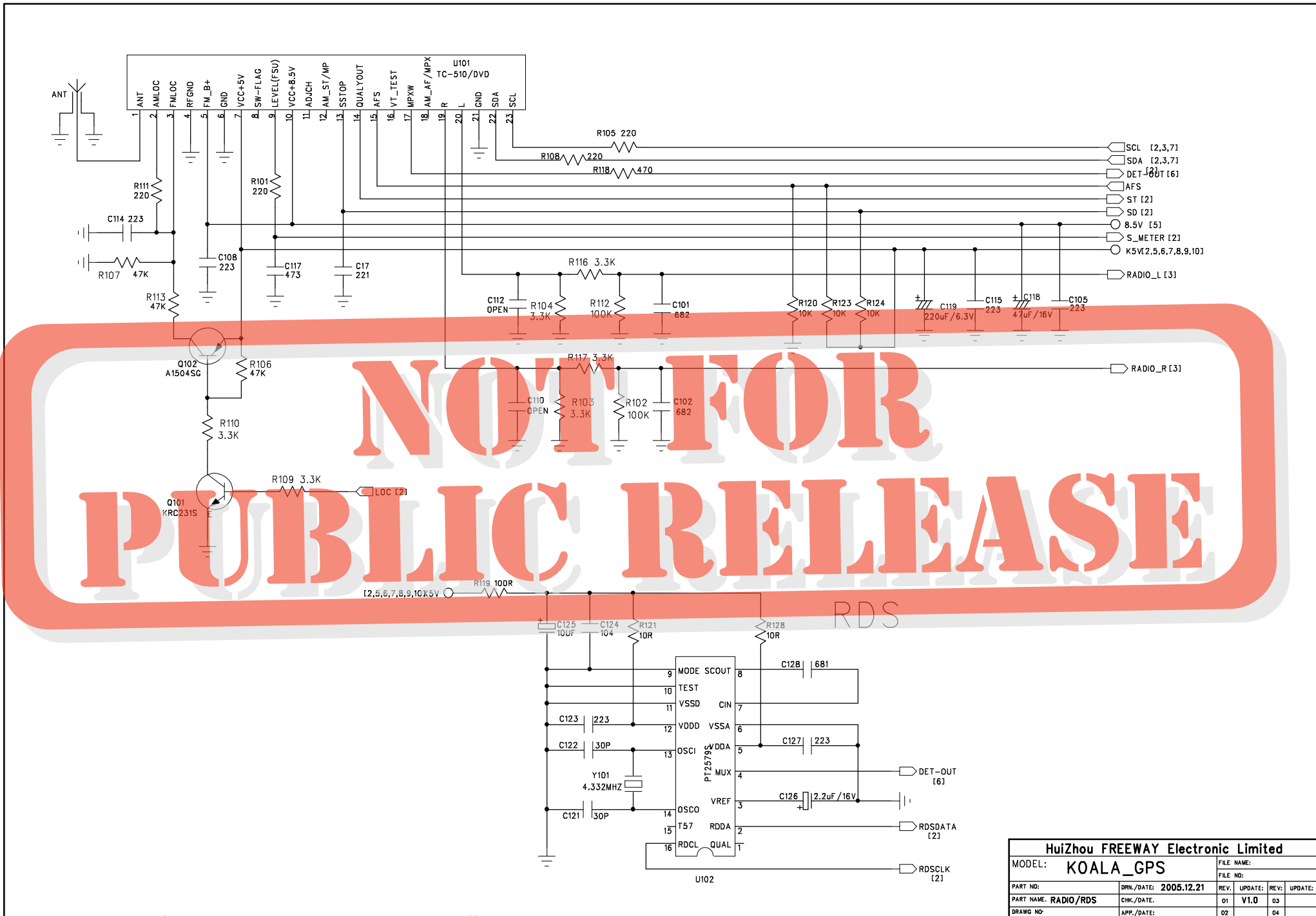

HuiZhou FREEWAY Electronic Limited			
MODEL:	KOALA_GPS	FILE NAME:	
PART NO:		REV. NO:	
PART NAME: RADIO/RDS	DRN./DATE: 2005.12.21	REV. UPDATE:	REV. UPDATE:
DRAWG NO:	CHK./DATE:	01 V1.0	03
	APP./DATE:	02	04

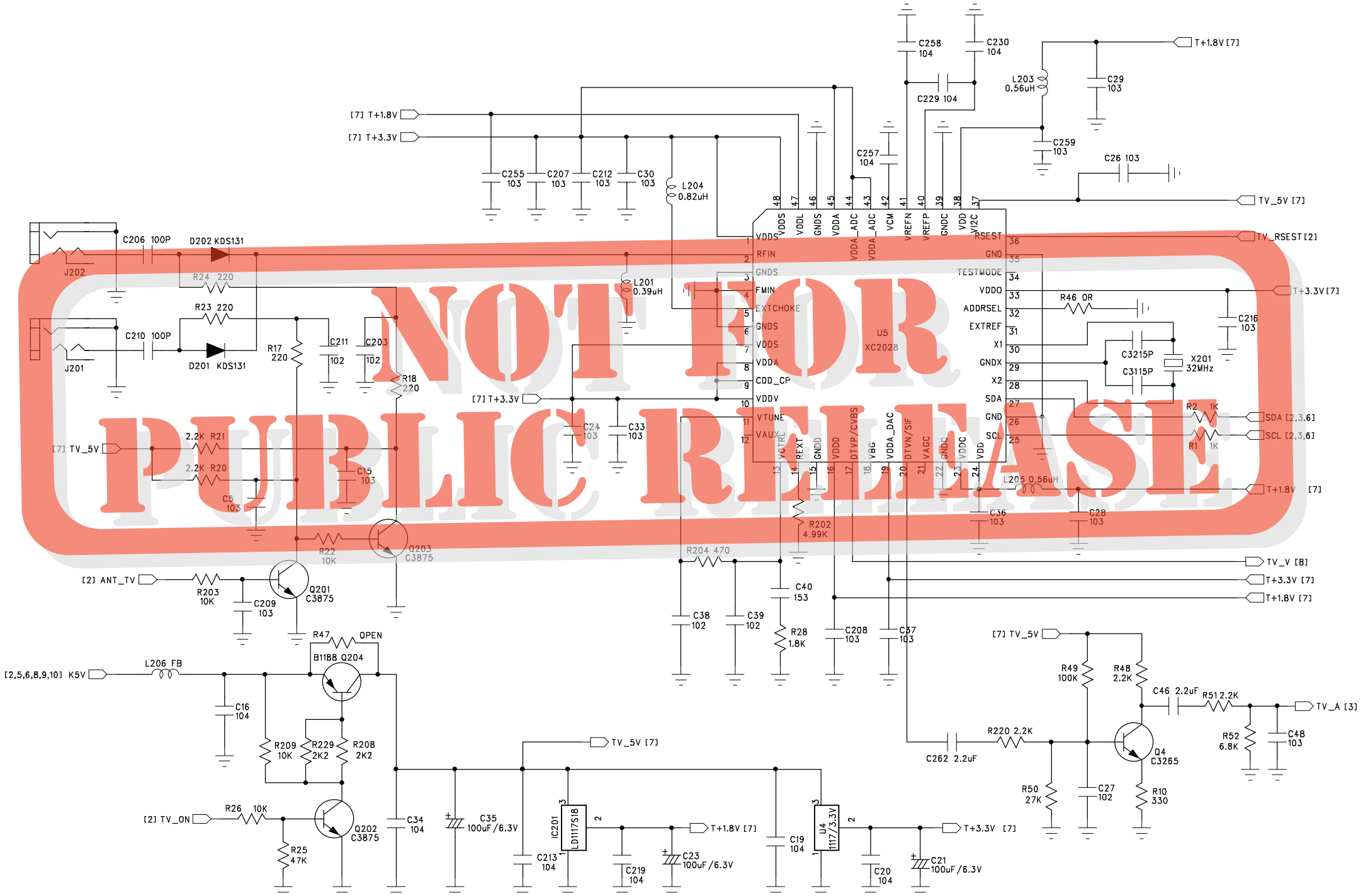

	SWA	SWB	SWE	SWC	SWD
REVERSE	L	L	L / H	L	L
DVD	H	L	L	H	L
TV	L	H	H	L	H
DVD_CH	H	H	L	H	H
AV	H	H	H	H	H

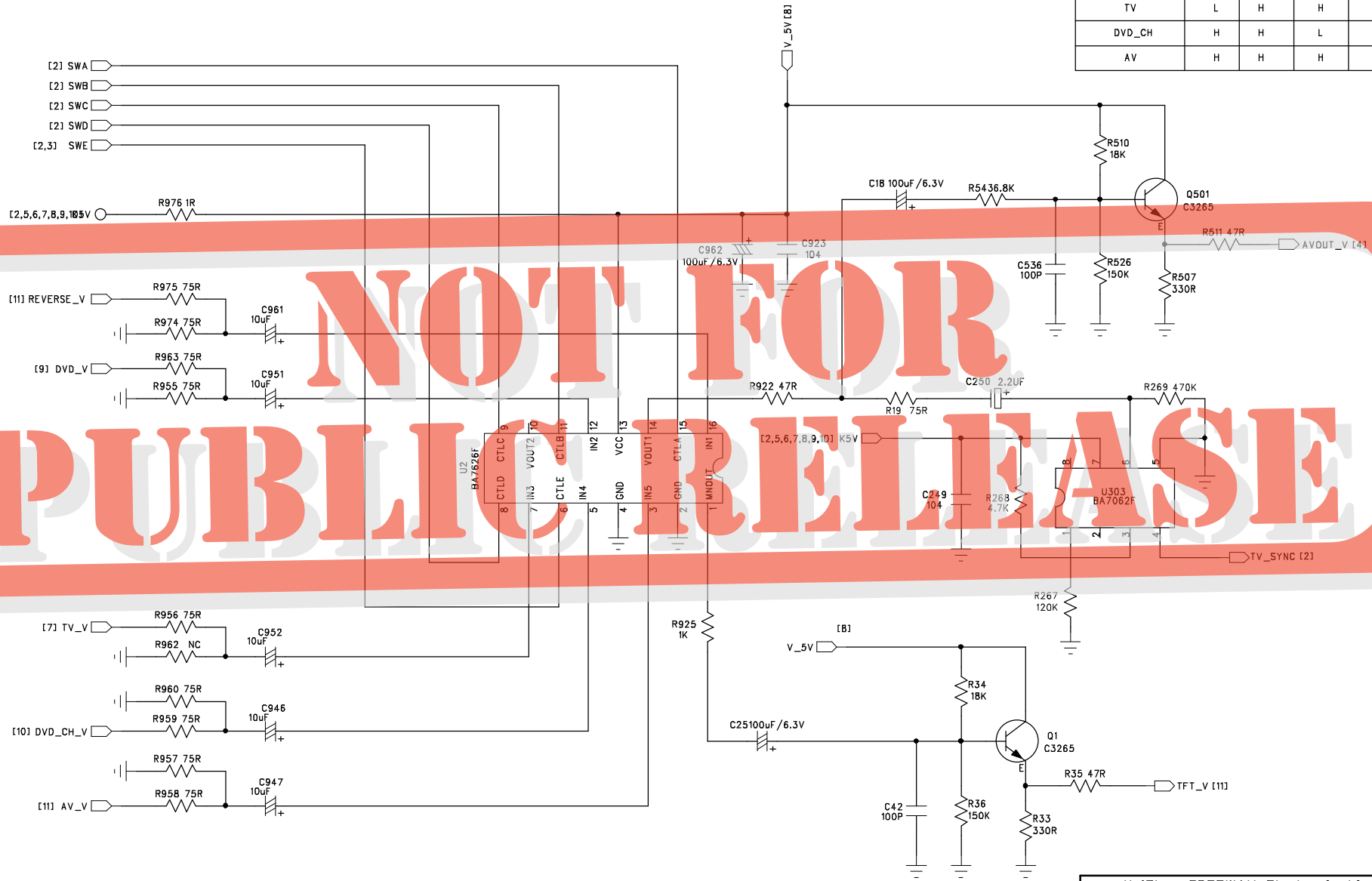

HuiZhou FREEWAY Electronic Limited					
MODEL:	KOALA_GPS			FILE NAME:	
PART NO:	DRN./DATE:	2005.12.21	REV.	UPDATE:	REV:
PART NAME: VIDEOSWITCH	CHK./DATE:		01	V1.0	03
DRAWG NO:	APP./DATE:		02		04

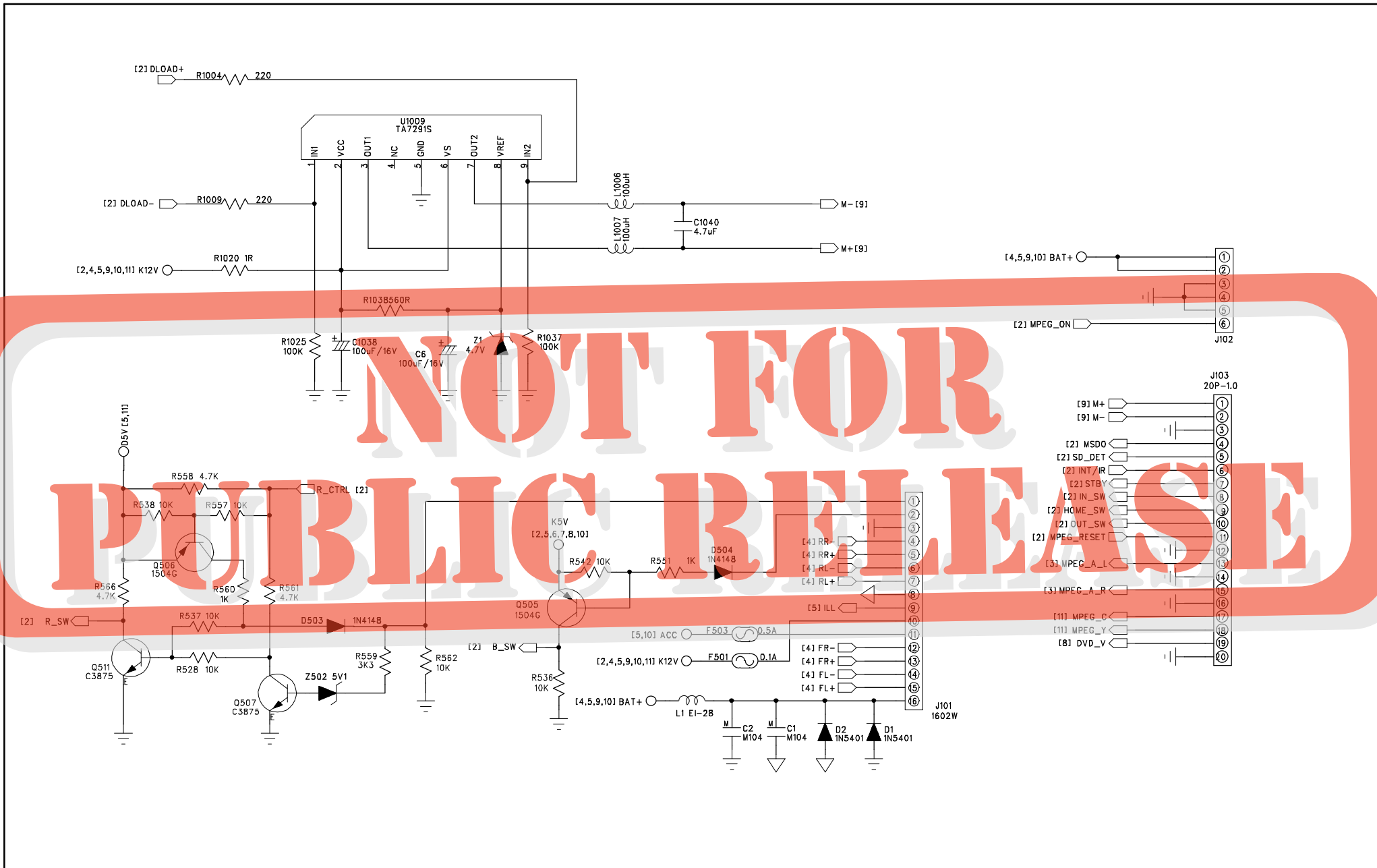

NOT FOR PUBLIC RELEASE

HuiZhou FREEWAY Electronic Limited			
MODEL:	KOALA_GPS		FILE NAME:
PART NO:	DRN./DATE:	2005.12.21	FILE NO:
PART NAME: CONNECT	CHK./DATE:	01 V1.0 03	REV. UPDATE: REV. UPDATE:
DRAWG NO:	APP./DATE:	02	04

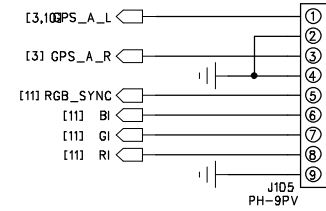
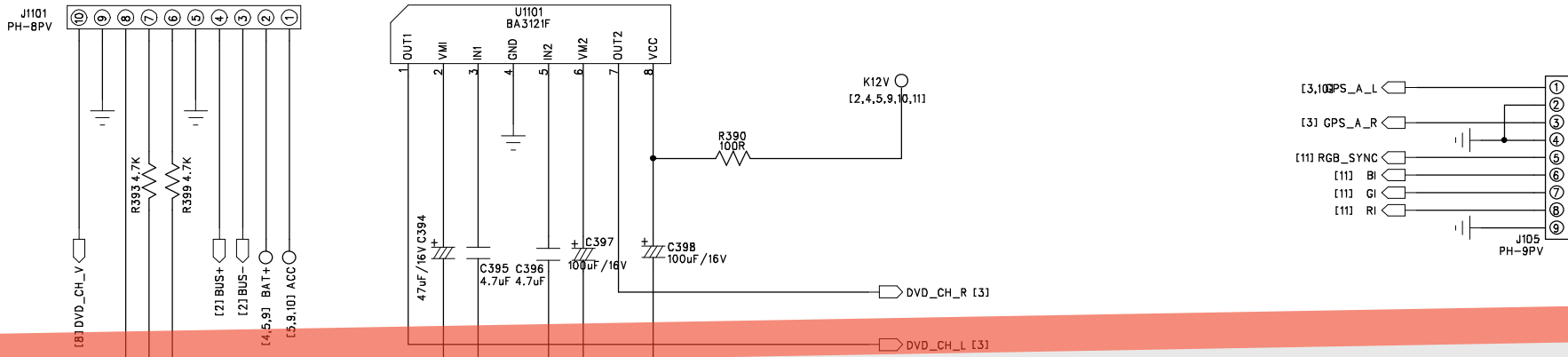

NOT FOR PUBLIC RELEASE

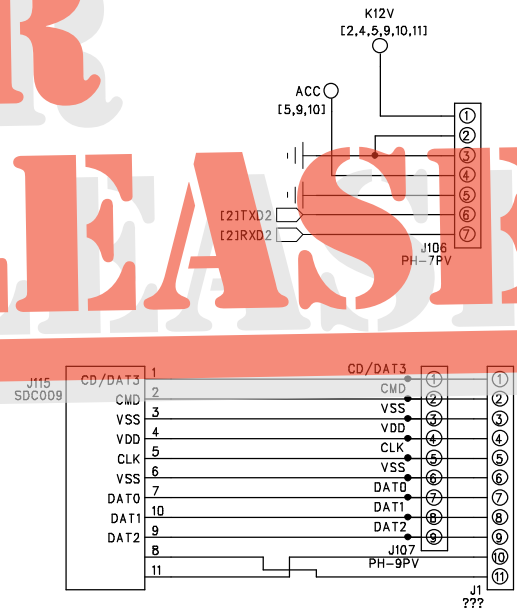
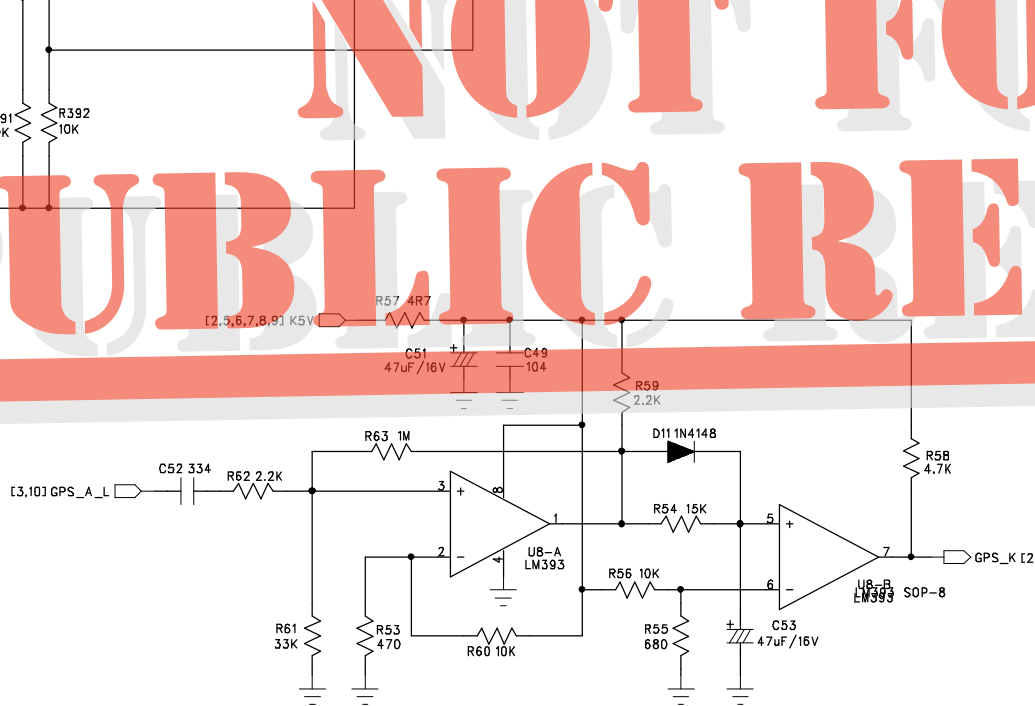

HuiZhou FREEWAY Electronic Limited			
MODEL:	KOALA_GPS		FILE NAME:
PART NO:	DRN./DATE:	2005.12.21	FILE NO:
PART NAME: GPS&DVDCHG	CHK./DATE:	01 V1.0 03	REV. UPDATE: REV. UPDATE:
DRAWG NO:	APP./DATE:	02	04

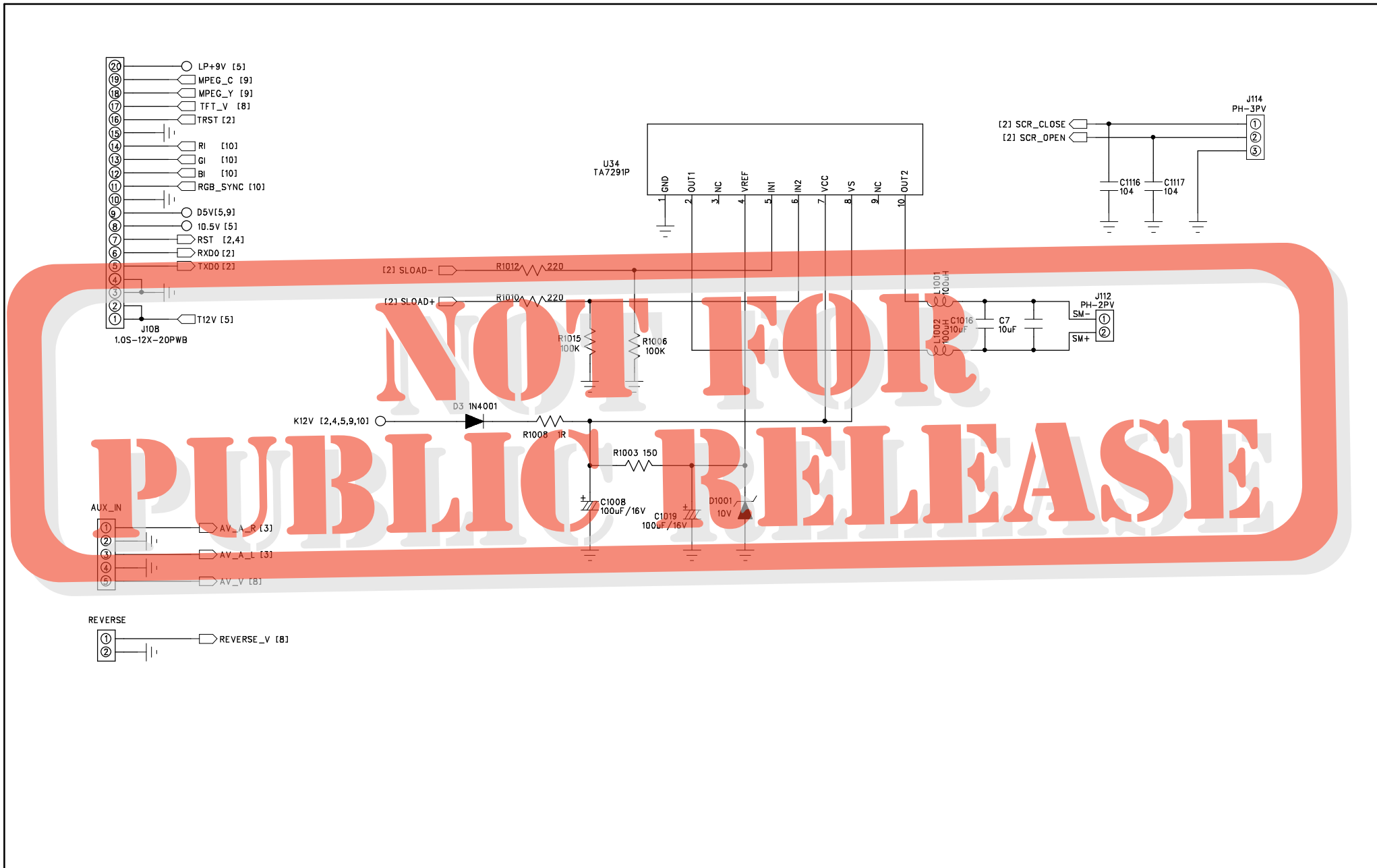

HuiZhou FREEWAY Electronic Limited			
MODEL:	KOALA_GPS	FILE NAME:	
PART NO:		FILE NO:	
PART NAME: TFT_CONNECT	CHK./DATE:	REV:	UPDATE:
DRAWG NO:	APP./DATE:	02	04

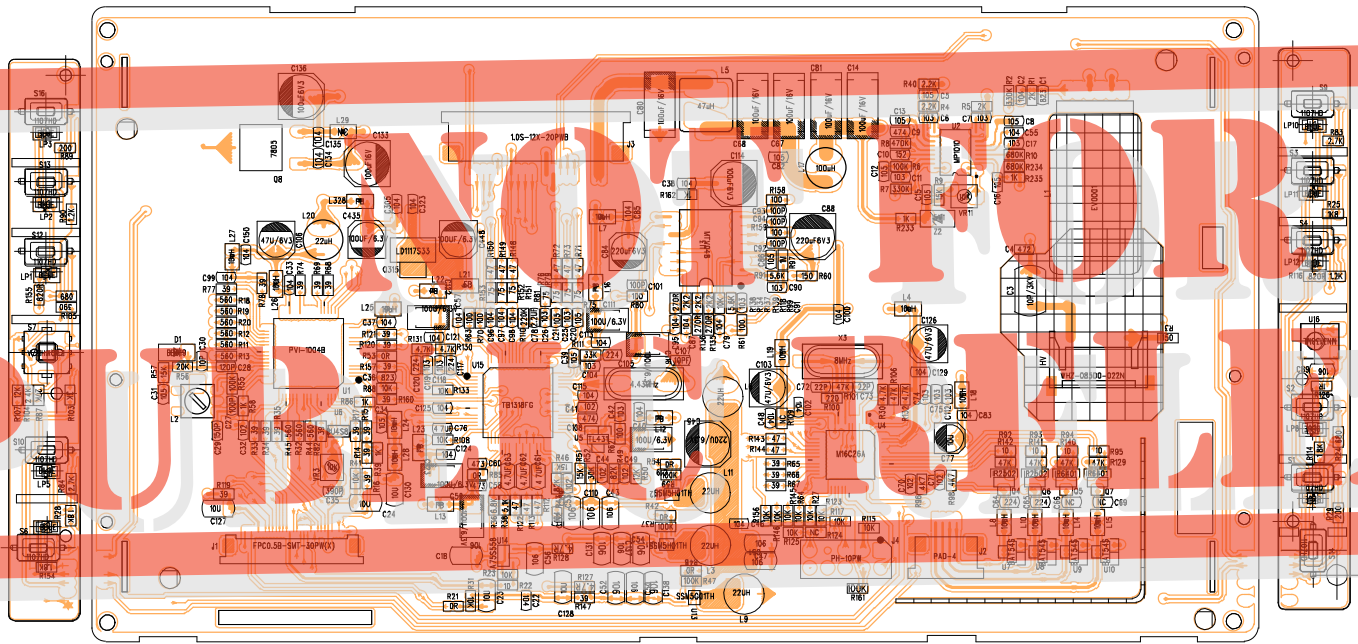

PLEASE

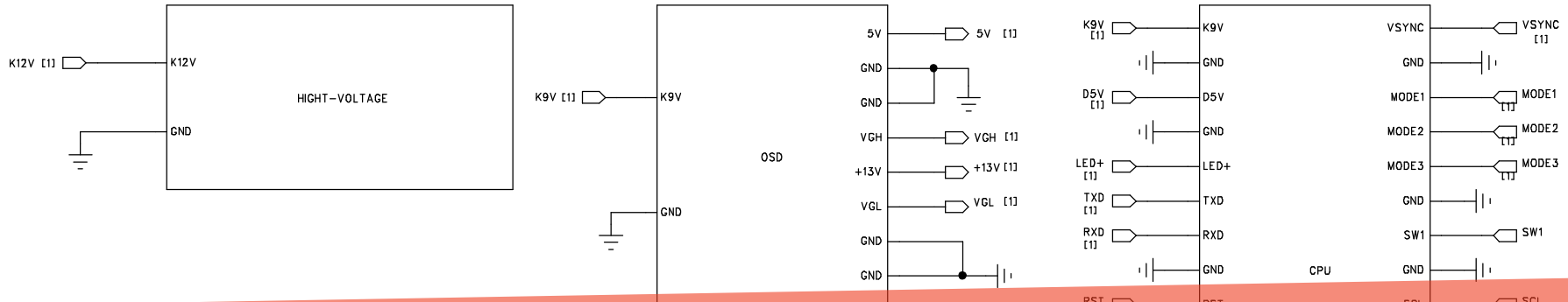

NOT FOR PUBLIC RELEASE

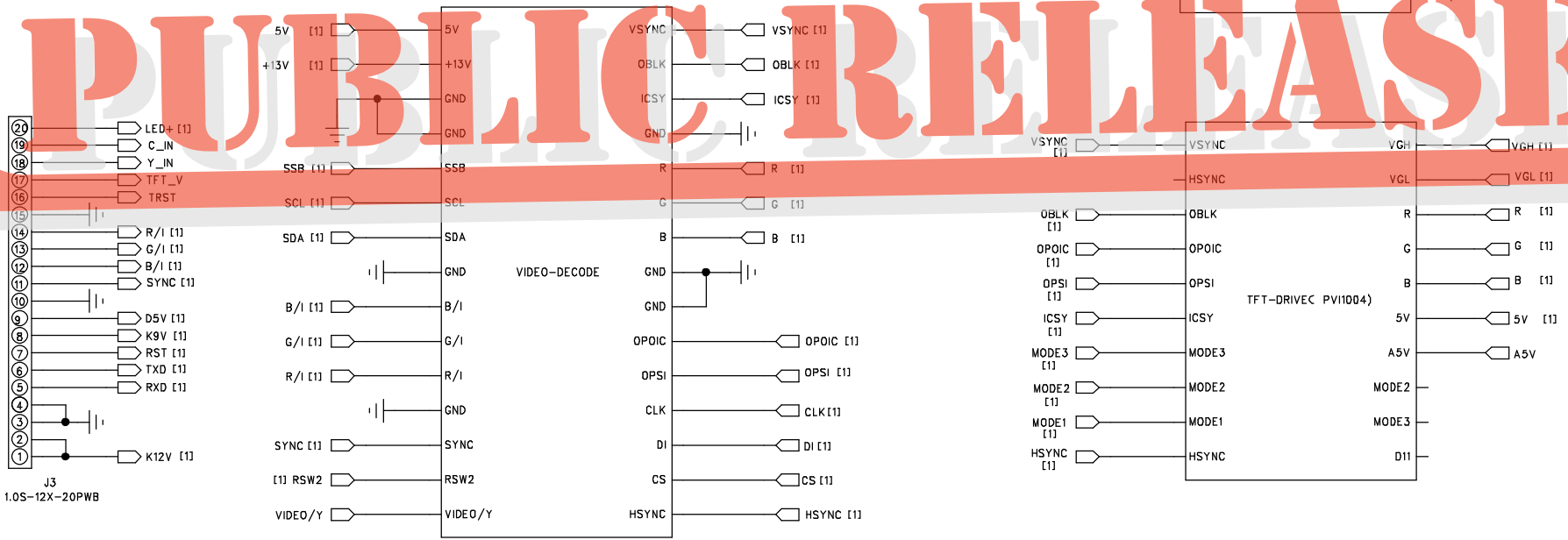

J3
1.0S-12X-20PWB

HuiZhou FREEWAY Electronic Limited			
MODEL:	DT060-TFT	FILE NAME:	
PART NO:	SC-806000-580-01	DRN./DATE:	D410D
PART NAME:	CHK./DATE:	REV:	UPDATE:
DRAWG NO:	APP./DATE:	01	03
		02	04

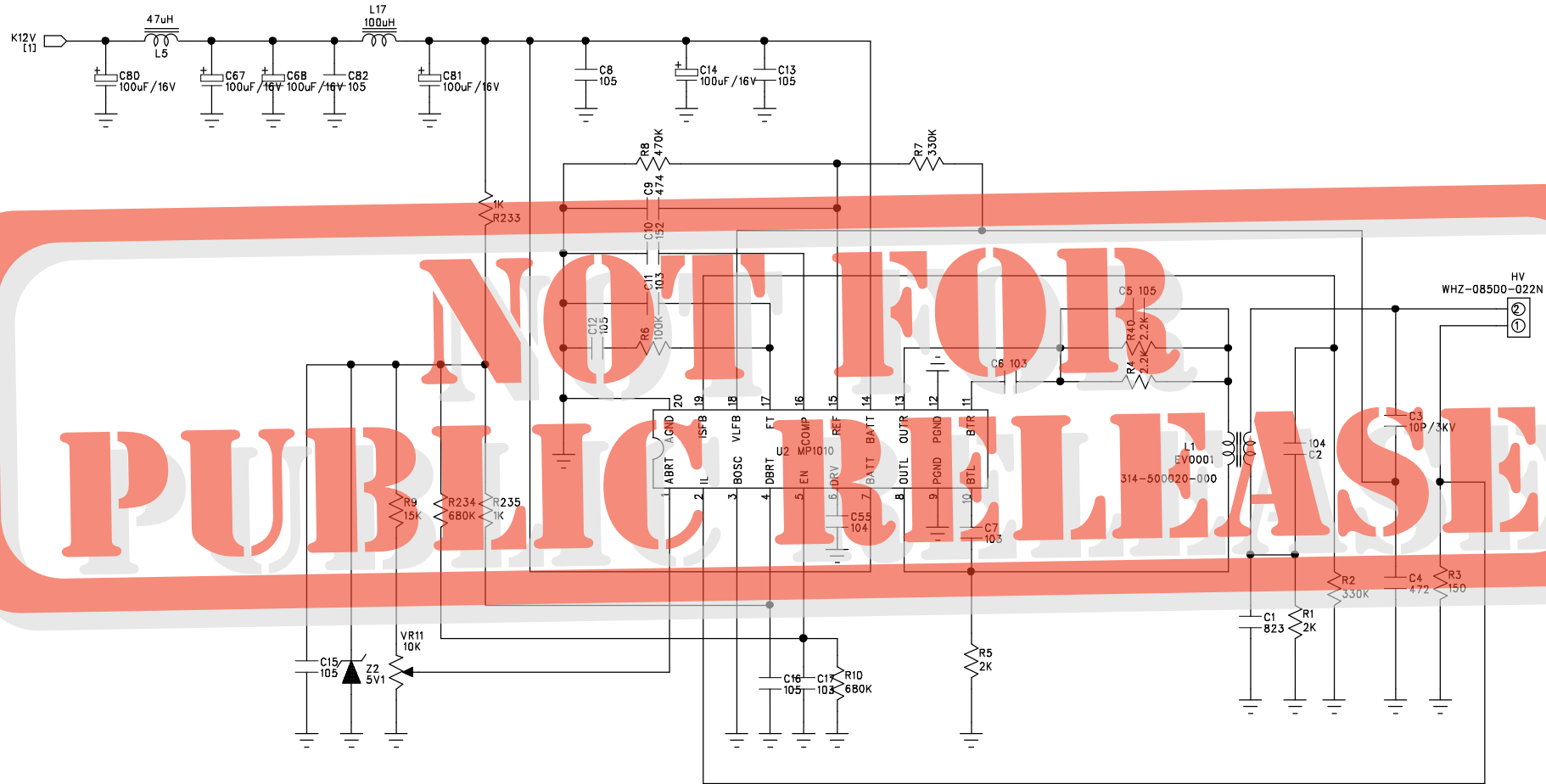

HuiZhou FREEWAY Electronic Limited				
MODEL:		FILE NAME:		
		FILE NO:		
PART NO:	DRN./DATE:	REV.	UPDATE:	REV.
PART NAME:	CHK./DATE:	01		03
DRAWG NO:	APP./DATE:	02		04

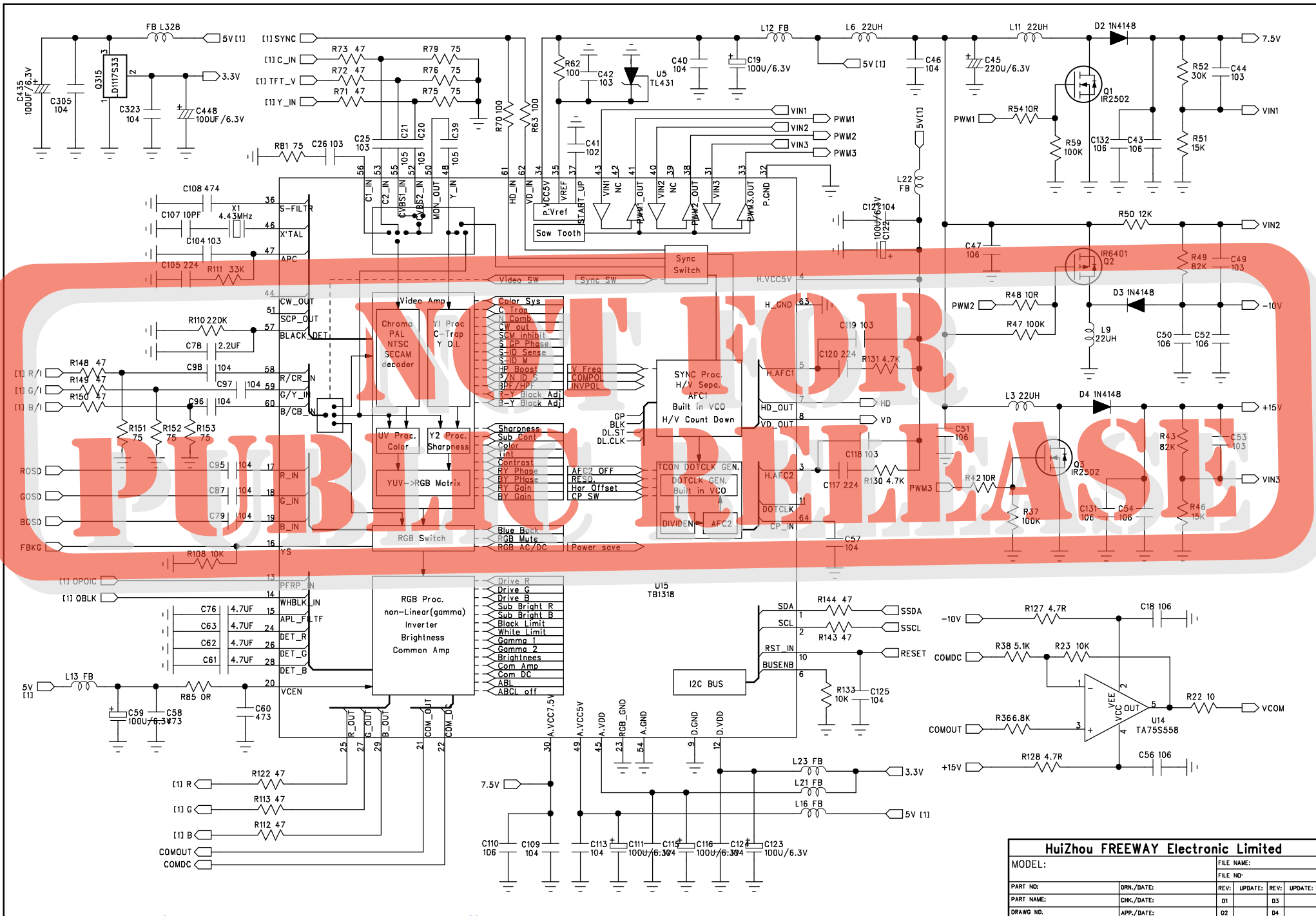

HuiZhou FREEWAY Electronic Limited					
MODEL:		FILE NAME:			
		FILE NO:			
PART NO:	DRN./DATE:	REV:	UPDATE:	REV:	UPDATE:
PART NAME:	CHK./DATE:	01		03	
DRAWG NO.	APP./DATE:	02		04	

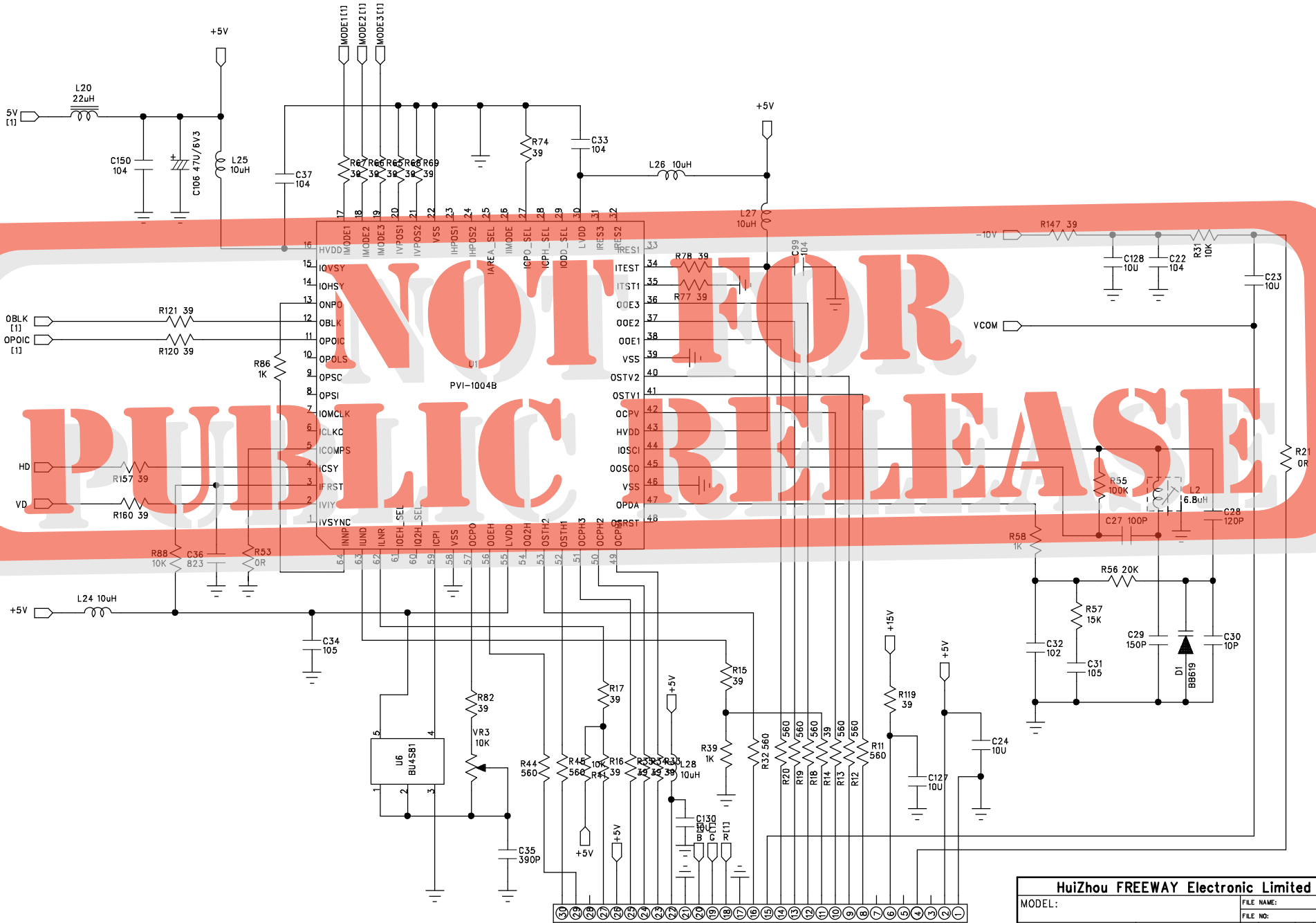

HuiZhou FREEWAY Electronic Limited				
MODEL:	FILE NAME:			
	FILE NO:			
PART NO:	DRN./DATE:	REV. UPDATE:	REV. UPDATE:	
PART NAME:	CHK./DATE:	01	03	
DRAWG NO:	APP./DATE:	02	04	

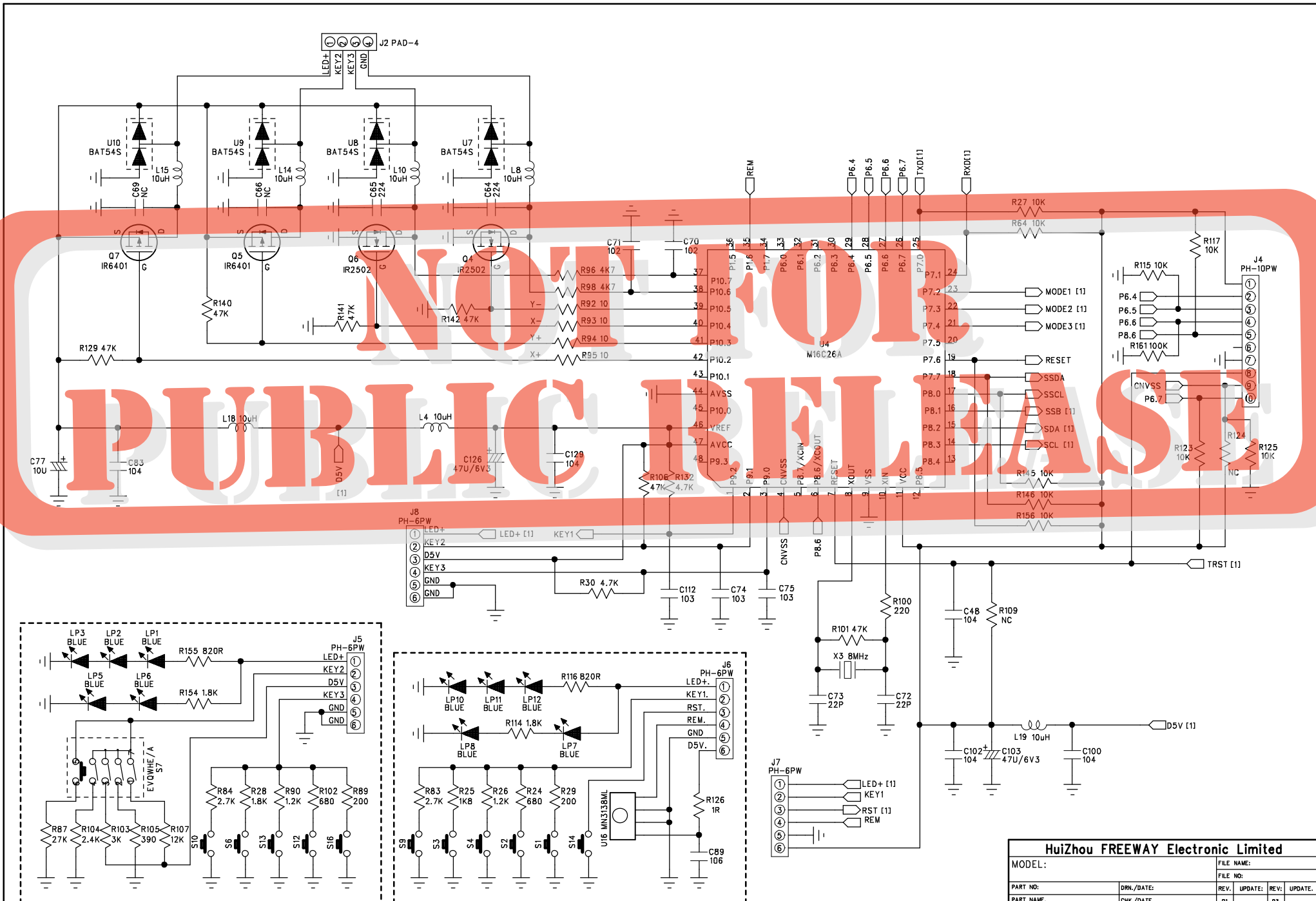

HuiZhou FREEWAY Electronic Limited			
MODEL:	FILE NAME:		
PART NO:	DRN./DATE:	REV. NO.:	REV. UPDATE:
PART NAME:	CHK./DATE:	01	03
DRAWG NO:	APP./DATE:	02	04

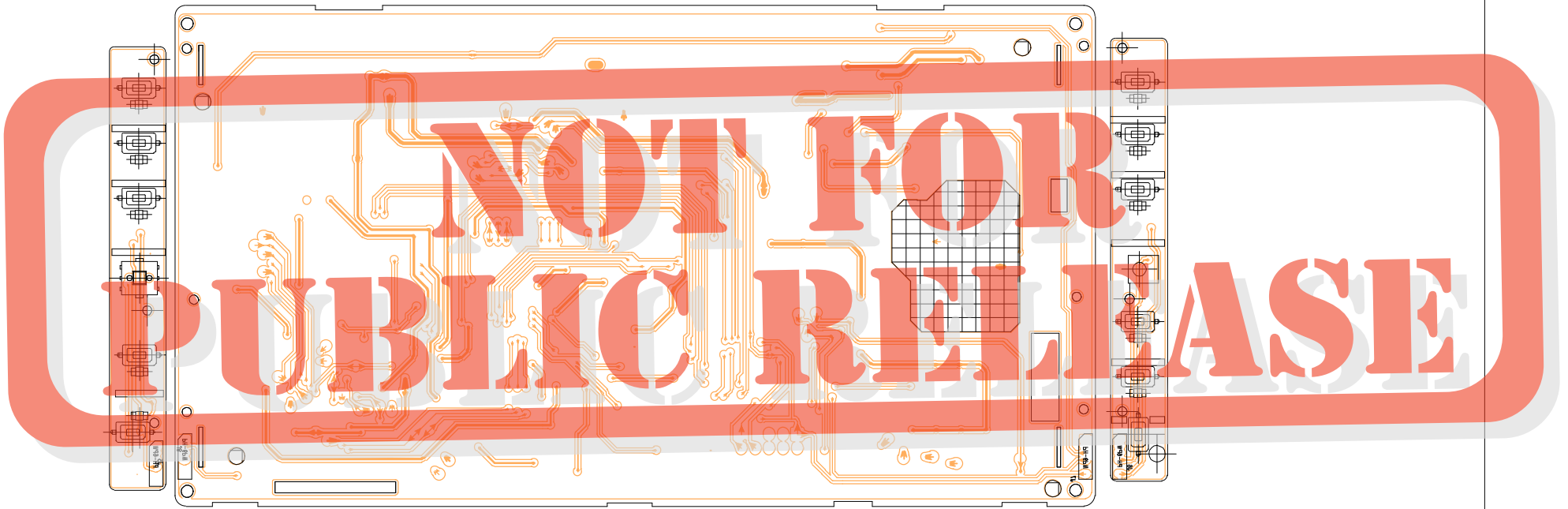



CONTINPIN

D2	104
J5	104
C103	104
C104	104
R180	1K5
VL104	E10 47K
R177	100R R181
VL103	E10 47K
R174	100R R178
VL102	E10 47K
R171	100R R175
VL101	E10 47K
R168	100R R172
VL100	E10 47K
R169	

MK1

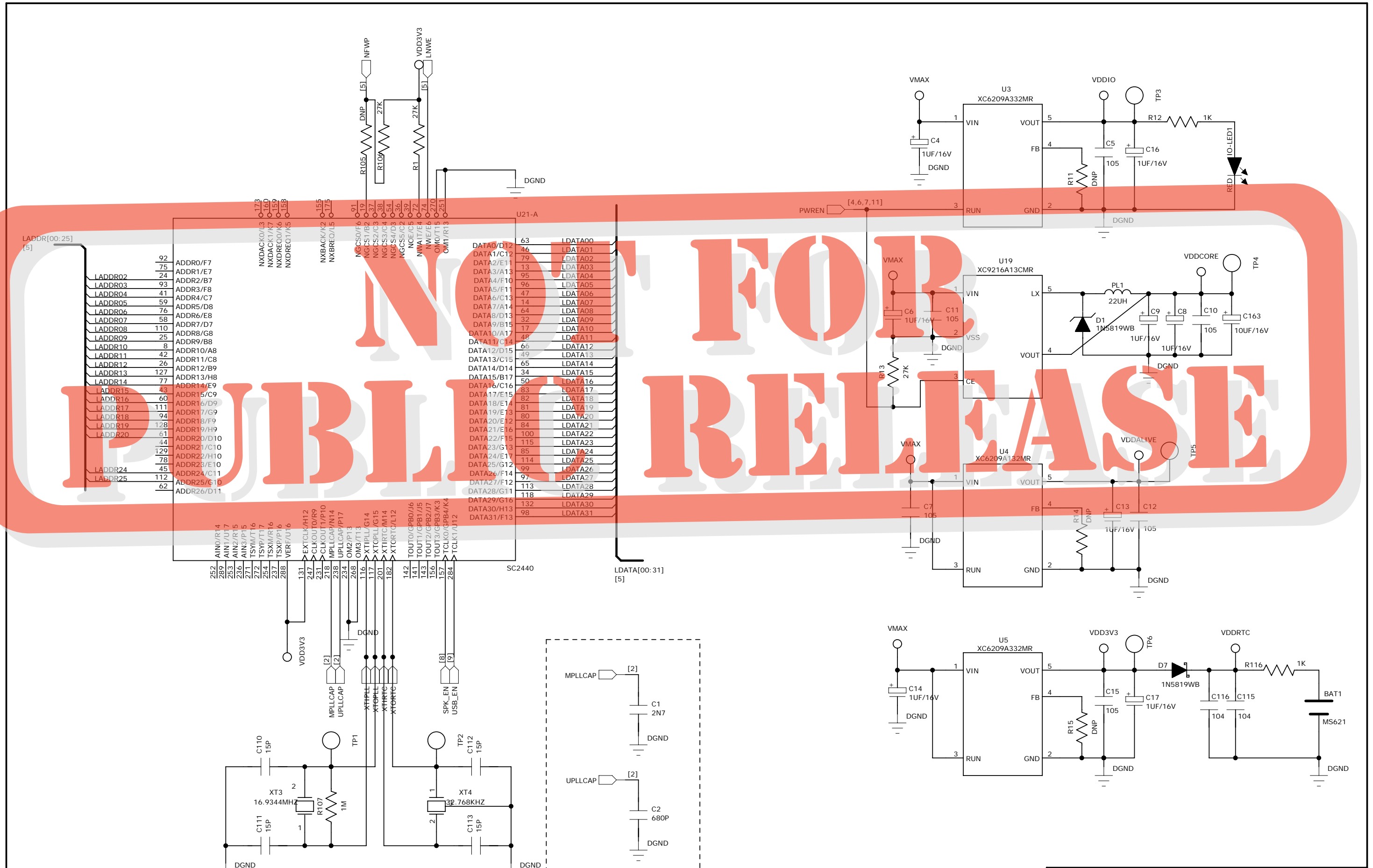

NOT FOR RELEASE

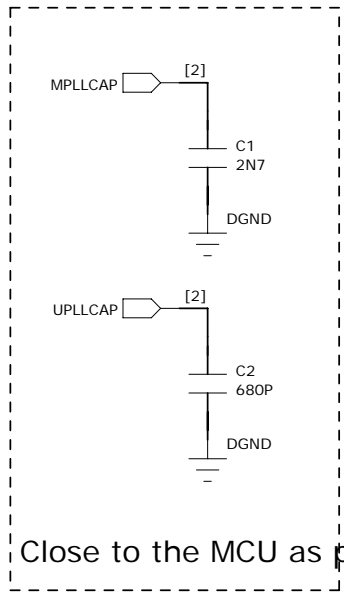

Close to the MCU as possible!

HuiZhou FREEWAY Electronic Limited					
MODEL: GPS-0701		FILE NAME:			
PART NO:		DRN./DATE: 2007.2.13		REV: UPDATE:	
PART NAME: MCU PART.A		CHK./DATE:		01	V1.0 03
DRAWG NO:		APP./DATE:		02	04

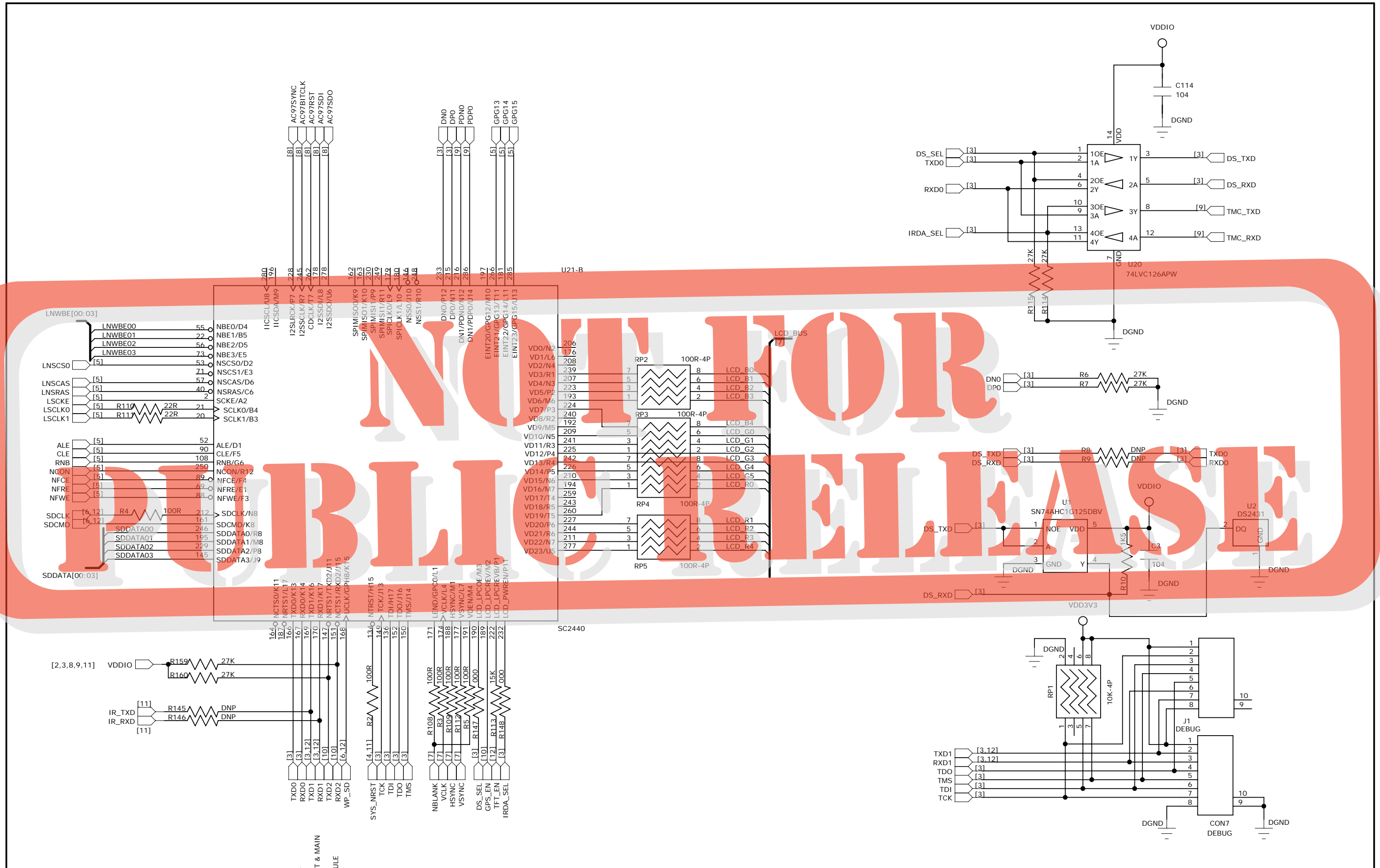

HuiZhou FREEWAY Electronic Limited					
MODEL:	GPS-0701			FILE NAME:	
PART NO:	DRN./DATE:	2007.2.13	REV:	UPDATE:	
PART NAME:	MCU PART.B	CHK./DATE:	01	V1.0	03
DRAWG NO:	APP./DATE:	02		04	

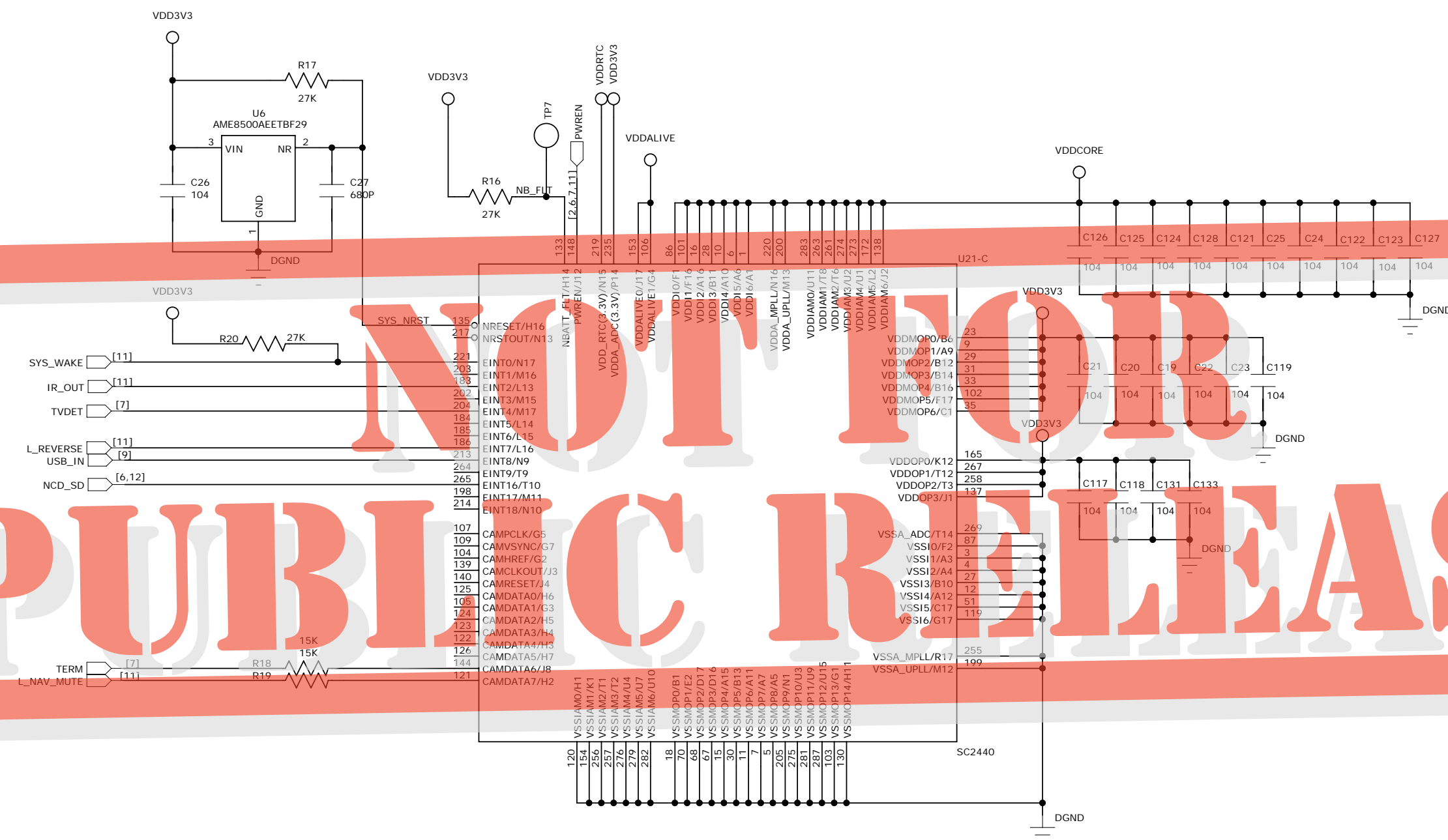

NOT FOR PUBLIC RELEASE

HuiZhou FREEWAY Electronic Limited				
MODEL: GPS-0701		FILE NAME:		
PART NO:		FILE NO:		
DRN./DATE: 2007.2.13	REV: 01	UPDATE: V1.0	REV: 03	UPDATE:
PART NAME: MCU PART.C	CHK./DATE:	02	04	
DRAWG NO:	APP./DATE:			

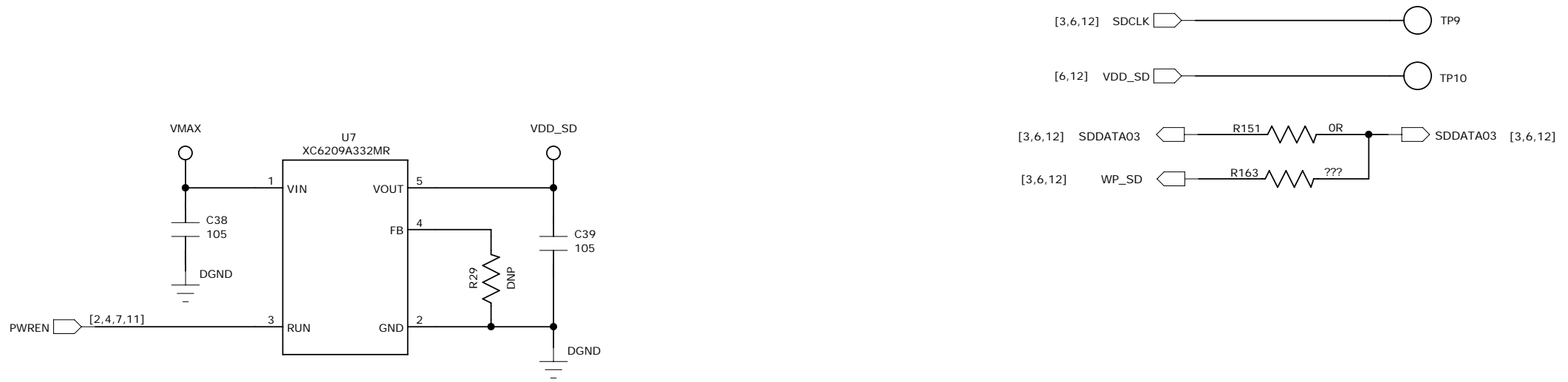
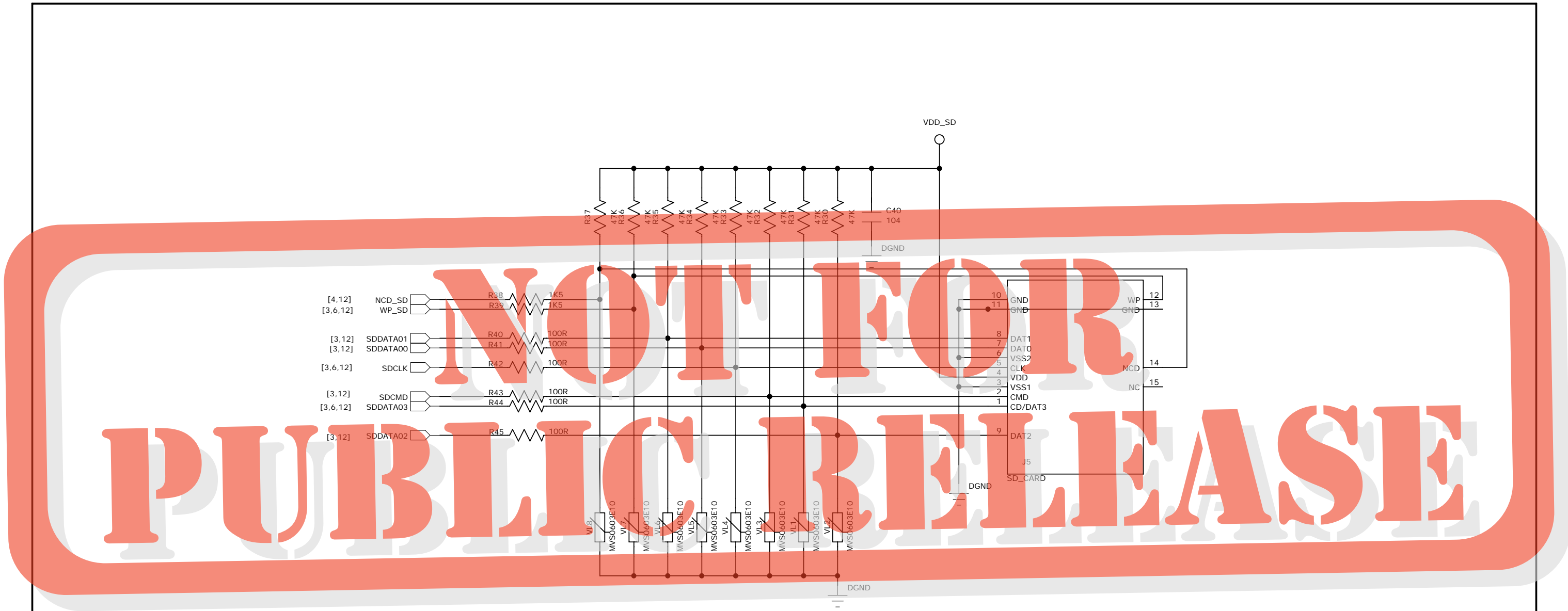

HuiZhou FREEWAY Electronic Limited				
MODEL: GPS-0701		FILE NAME:		
PART NO:		FILE NO:		
DRN./DATE: 2007.2.13	REV: 01	UPDATE: V1.0	REV: 03	UPDATE:
PART NAME: SD CARD	CHK./DATE:	02	04	
DRAWG NO:	APP./DATE:			

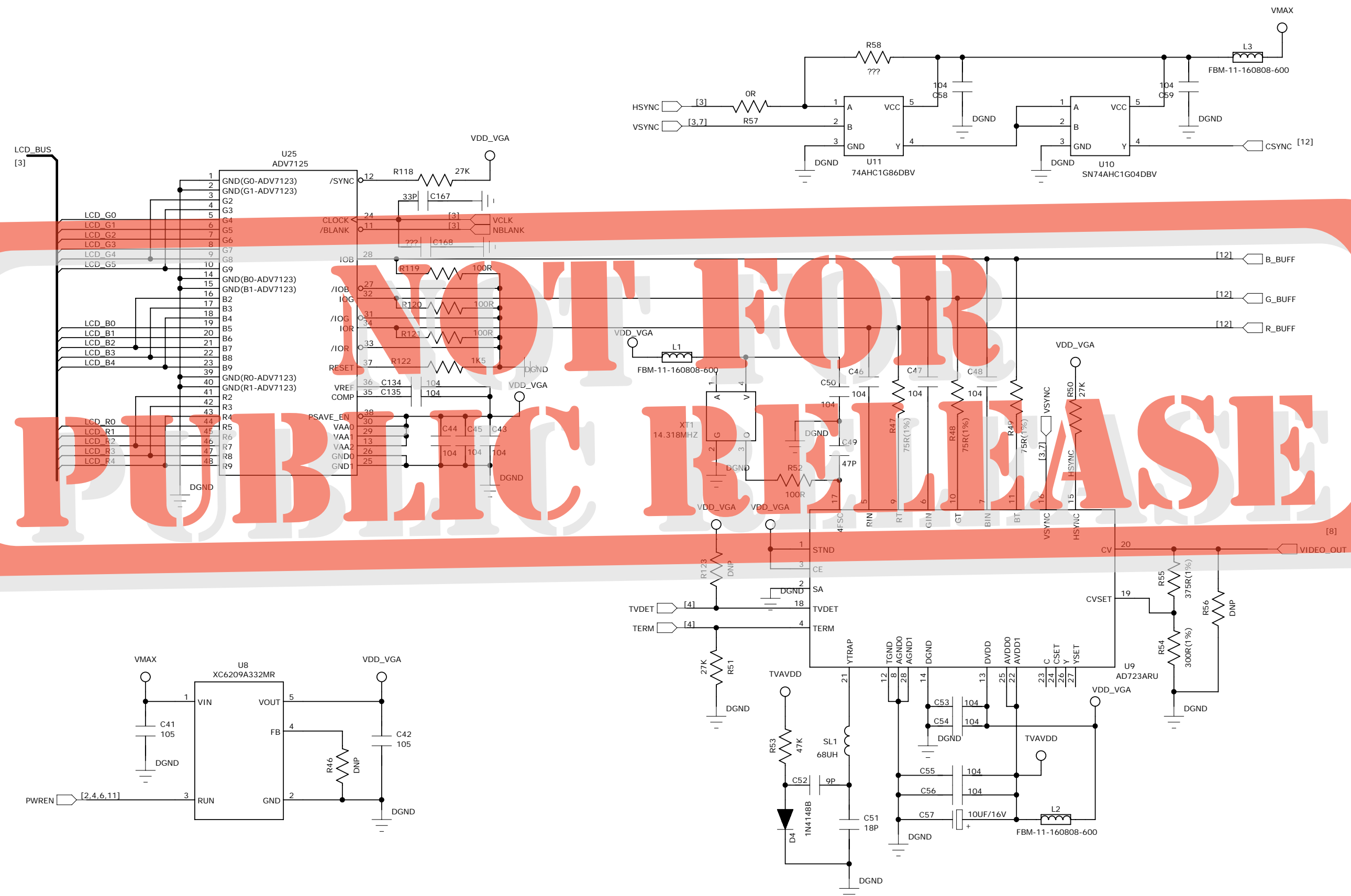

NOT FOR PUBLIC RELEASE

HuiZhou FREEWAY Electronic Limited				
MODEL: GPS-0701		FILE NAME:		
PART NO:		FILE NO:		
DRN./DATE: 2007.2.13	REV: 01	UPDATE: 03	REV: 03	UPDATE:
PART NAME: RGB & VIDEO	CHK./DATE:	02	V1.0	04
DRAWG NO:	APP./DATE:			

	SWA	SWB	B_SW	SWC	SWD
AV	L	L	L / H	L	L
DVD	H	L	L / H	H	L
TV	L	H	L / H	L	H
DVD_CH	H	H	L	H	H
REVERSE	H	H	H	H	H

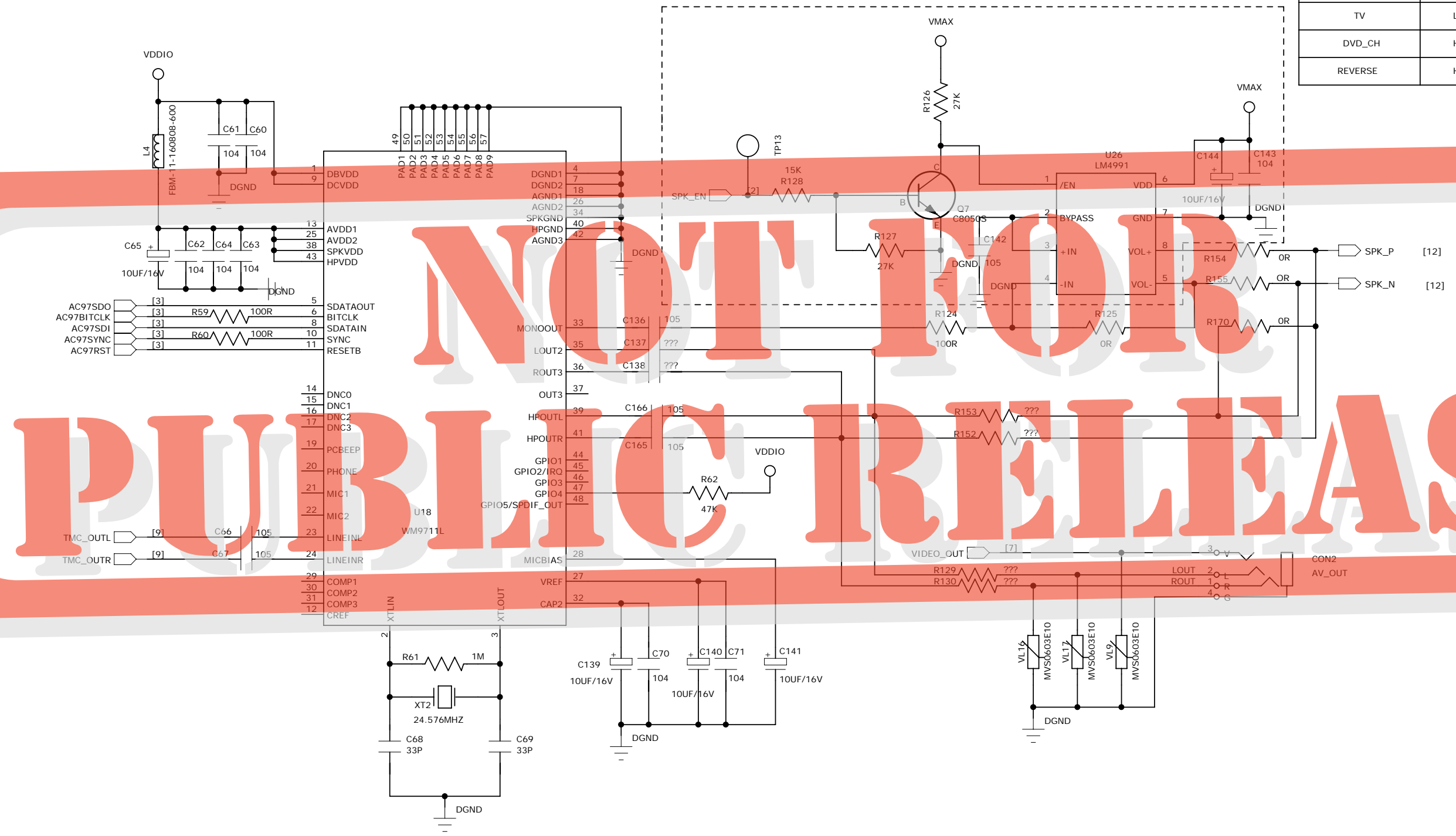

NOT FOR RELEASE

HuiZhou FREEWAY Electronic Limited					
MODEL: GPS-0701			FILE NAME:		
PART NO:			FILE NO:		
PART NAME: AC97		DRN./DATE: 2007.2.13	REV: 01	UPDATE: V1.0	REV: 03
DRAWG NO:		APP./DATE:	02	04	

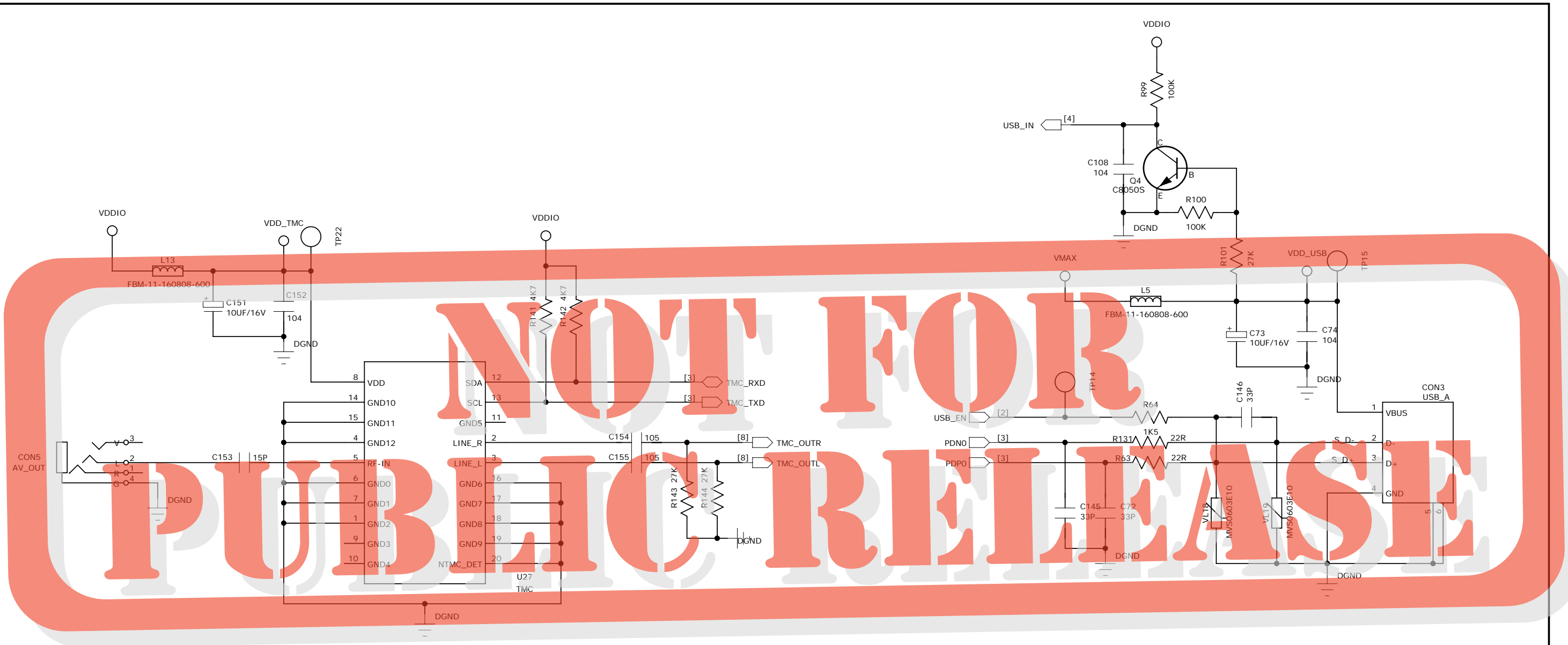

Default is USB slave, But if place BLM18PG600SN1, and replace 47P*2 with 15K*2, and 1K5 is DNP, then the USB port is change to HOST!

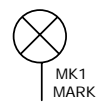

MK1 MARK

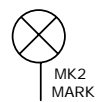

MK2 MARK

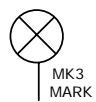

MK3 MARK



MK4 MARK

PCB Mark Point, place at the angle!

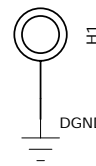

H1

DGND

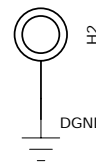

H2

DGND

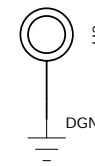

H3

DGND

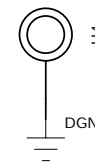

H4

DGND

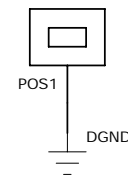

POS1

DGND

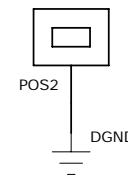

POS2

DGND

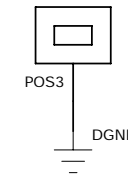

POS3

DGND

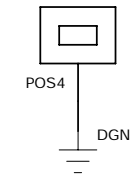

POS4

DGND

HuiZhou FREEWAY Electronic Limited				
MODEL:	GPS-0701		FILE NAME:	
PART NO:	DRN./DATE:	2007.2.13	REV.:	UPDATE:
PART NAME:	USB	CHK./DATE:	01	V1.0 03
DRAWG NO:	APP./DATE:	02		04

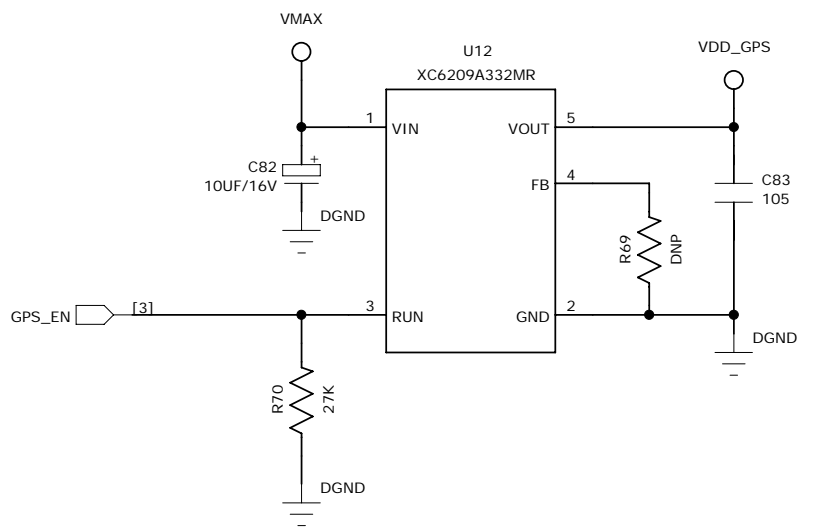
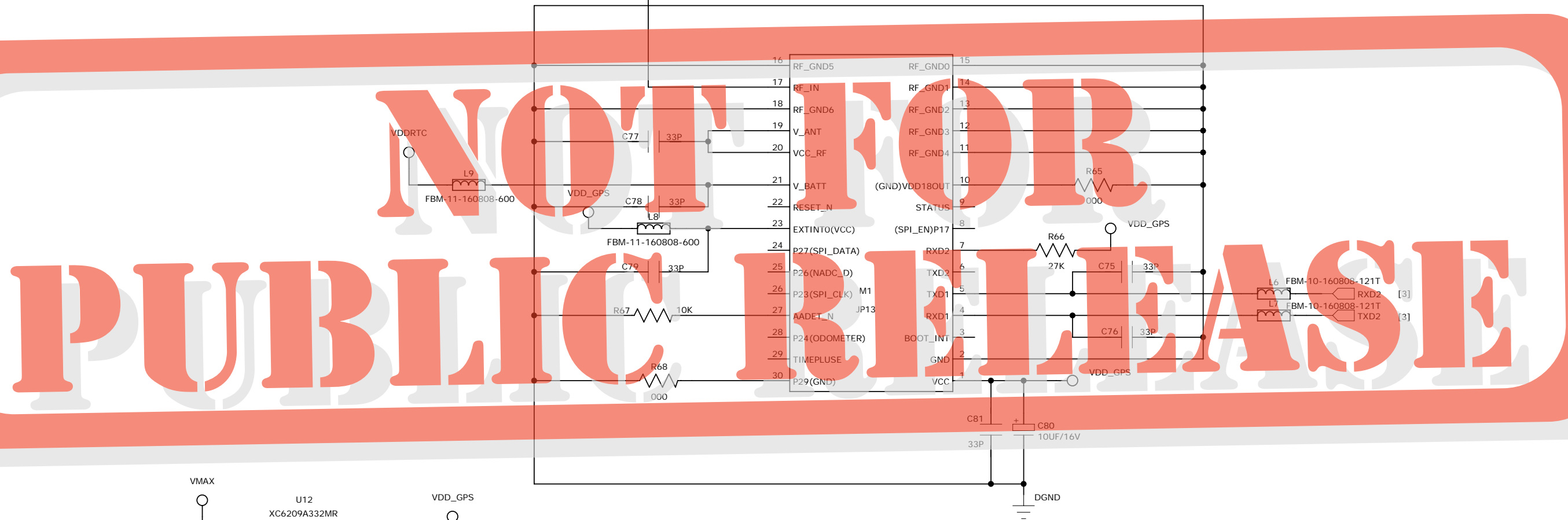
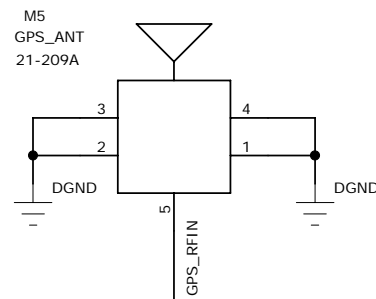

NOT FOR PUBLIC RELEASE

HuiZhou FREEWAY Electronic Limited				
MODEL: GPS-0701		FILE NAME:		
PART NO:		FILE NO:		
PART NAME: JP13_SIRFIII	DRN./DATE: 2007.2.13	REV: 01	UPDATE: V1.0	REV: 03
DRAWG NO:	APP./DATE:	02	04	

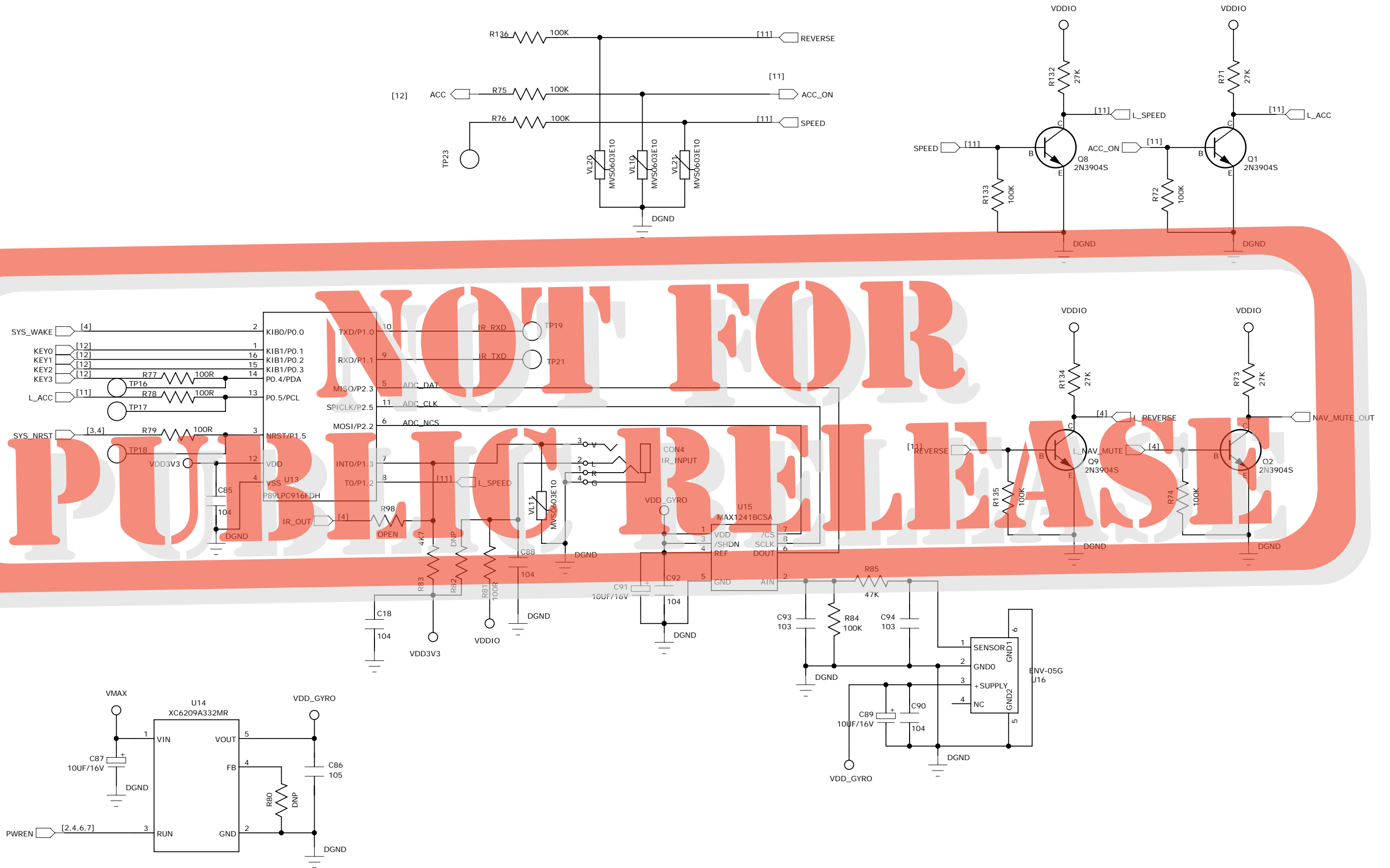

HuiZhou FREEWAY Electronic Limited				
MODEL: GPS-0701		FILE NAME:		
PART NO:		FILE NO:		
DRN./DATE: 2007.2.13	REV: 01	UPDATE: V1.0	REV: 03	UPDATE:
PART NAME: CONNECTOR	CHK./DATE:	02	04	
DRAWG NO:	APP./DATE:			

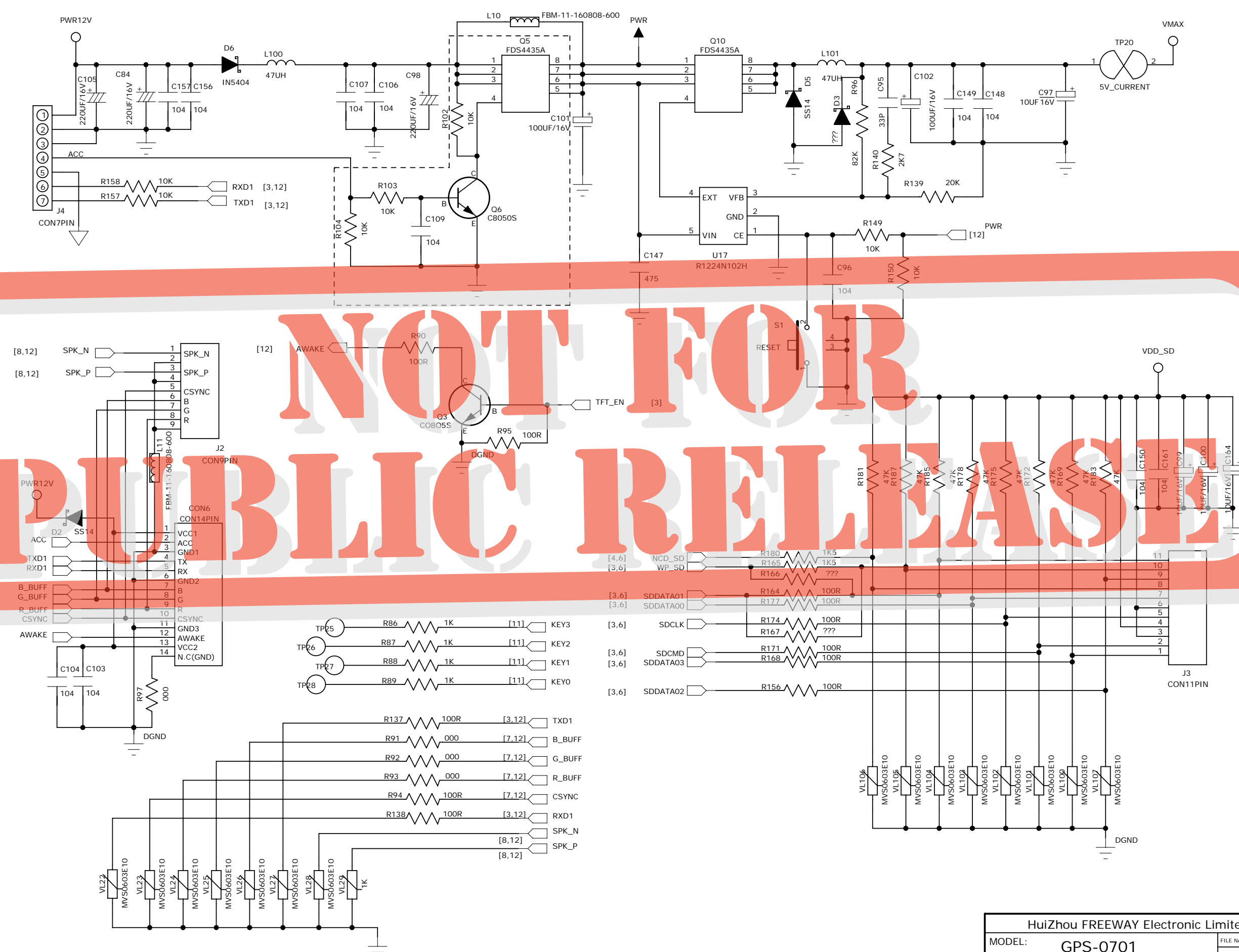

NOT FOR PUBLIC RELEASE

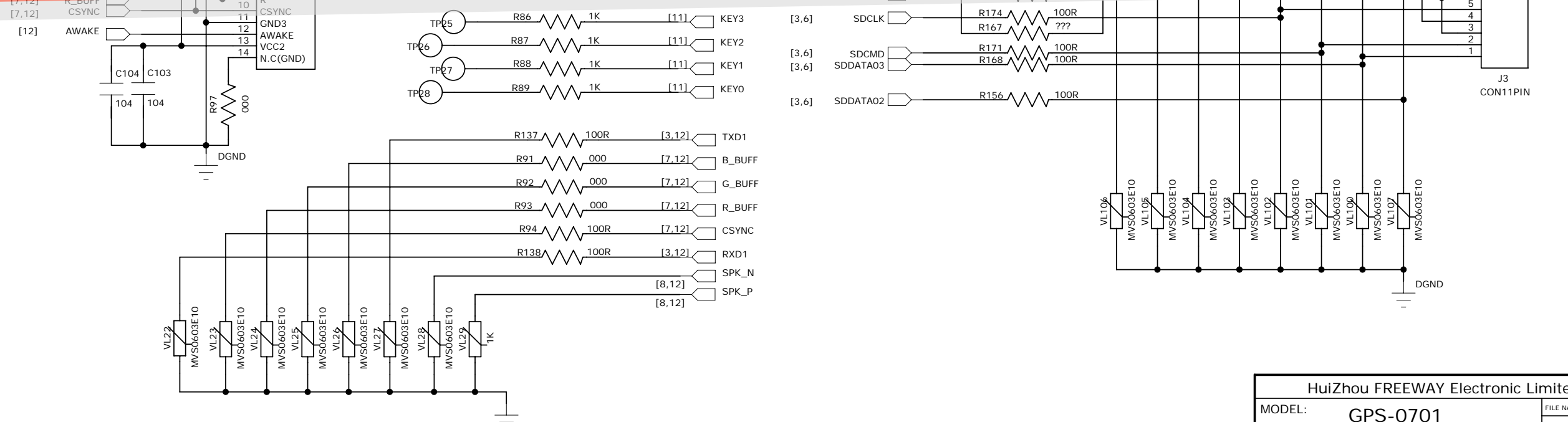

HuiZhou FREEWAY Electronic Limited				
MODEL:	GPS-0701		FILE NAME:	
PART NO.:	DRN./DATE:	2007.2.13	FILE NO.:	
PART NAME: POWER-SUPPLY	CHK./DATE:	01 V1.0 03	REV. UPDATE:	
DRAWG NO.:	APP./DATE:	02	04	

Simple Troubleshooting Guide

Problem	Cause/Solution
No power.	★Check and make sure whether the fuse is blown,replace with the proper value if necessary.
Some errors occur in the LCD or no function when pressing the button.	★Press the RESET button.
Unable to receive stations.	★Check and make sure whether the antenna is inserted or the antenna is properly connected,if so,insert the antenna or connect it properly.
Poor effect on receiving a station.	<p>★Antenna may not be the proper length.Make sure the antenna is fully extended or broken;if broken,replace the antenna with a new one.</p> <p>★The antenna is poorly grounded,check and make sure the antenna is properly grounded at its mounting location.</p>
CDs cannot be loaded.	★A CD is loaded in the mechanism.
Sound skips.	★The CD is dirty or damaged.
No images.	★The Video line from main to the TV is not connected properly.
Images skip.	★Improper setting of the color system.Set the color system to PAL or NTSC according to the connections of the TV.