

# JVC

## SCHEMATIC DIAGRAMS

COLOUR TELEVISION

### AV-21TMG4/G, AV-21TMG4/s, AV-2104T/E

CD-ROM No.SML200410

BASIC CHASSIS

CW

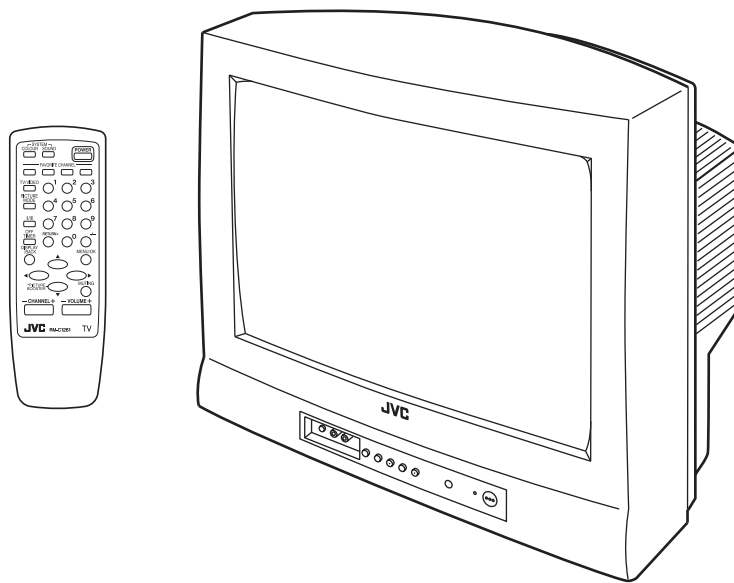



# AV-21TMG4/G, AV-21TMG4/S, AV-2104T/E

## STANDARD CIRCUIT DIAGRAM

### NOTE ON USING CIRCUIT DIAGRAMS

#### 1.SAFETY

The components identified by the  $\triangle$  symbol and shading are critical for safety. For continued safety replace safety critical components only with manufactures recommended parts.

#### 2.SPECIFIED VOLTAGE AND WAVEFORM VALUES

The voltage and waveform values have been measured under the following conditions.

- (1)Input signal : Colour bar signal
- (2)Setting positions of each knob/button and variable resistor : Original setting position when shipped
- (3)Internal resistance of tester : DC 20k $\Omega$ /V
- (4)Oscilloscope sweeping time : H  $\Rightarrow$  20 $\mu$ s / div  
: V  $\Rightarrow$  5ms / div  
: Others  $\Rightarrow$  Sweeping time is specified
- (5)Voltage values : All DC voltage values

\* Since the voltage values of signal circuit vary to some extent according to adjustments, use them as reference values.

#### 3.INDICATION OF PARTS SYMBOL [EXAMPLE]

- In the PW board : R209  $\rightarrow$  R209

#### 4.INDICATIONS ON THE CIRCUIT DIAGRAM

##### (1)Resistors

###### ● Resistance value

- No unit : [ $\Omega$ ]
- K : [k $\Omega$ ]
- M : [M $\Omega$ ]

###### ● Rated allowable power

- No indication : 1/16 [W]
- Others : As specified

###### ● Type

- No indication : Carbon resistor
- OMR : Oxide metal film resistor
- MFR : Metal film resistor
- MPR : Metal plate resistor
- UNFR : Uninflammable resistor
- FR : Fusible resistor

\* Composition resistor 1/2 [W] is specified as 1/2S or Comp.

##### (2)Capacitors

###### ● Capacitance value

- 1 or higher : [pF]
- less than 1 : [ $\mu$ F]

###### ● Withstand voltage

- No indication : DC50[V]
- Others : DC withstand voltage [V]
- AC indicated : AC withstand voltage [V]

\* Electrolytic Capacitors

47/50[Example]: Capacitance value [ $\mu$ F]/withstand voltage[V]

###### ● Type

- No indication : Ceramic capacitor
- MM : Metalized mylar capacitor
- PP : Polypropylene capacitor
- MPP : Metalized polypropylene capacitor
- MF : Metalized film capacitor
- TF : Thin film capacitor
- BP : Bipolar electrolytic capacitor
- TAN : Tantalum capacitor

##### (3)Coils

- No unit : [ $\mu$ H]
- Others : As specified

##### (4)Power Supply



\* Respective voltage values are indicated

##### (5)Test point



##### (6)Connecting method

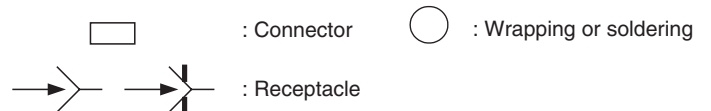

##### (7)Ground symbol

- $\perp$  : LIVE side ground
- $\updownarrow$  : ISOLATED(NEUTRAL) side ground
- $\equiv$  : EARTH ground
- $\nabla$  : DIGITAL ground

#### 5.NOTE FOR REPAIRING SERVICE

This model's power circuit is partly different in the GND. The difference of the GND is shown by the LIVE ( $\perp$ ) side GND and the ISOLATED(NEUTRAL) ( $\updownarrow$ ) side GND. Therefore, care must be taken for the following points.

- (1)Do not touch the LIVE side GND or the LIVE side GND and the ISOLATED(NEUTRAL) side GND simultaneously. if the above caution is not respected, an electric shock may be caused. Therefore, make sure that the power cord is surely removed from the receptacle when, for example, the chassis is pulled out.
- (2)Do not short between the LIVE side GND and ISOLATED(NEUTRAL) side GND or never measure with a measuring apparatus measure with a measuring apparatus ( oscilloscope, etc.) the LIVE side GND and ISOLATED(NEUTRAL) side GND at the same time. If the above precaution is not respected, a fuse or any parts will be broken.

◆ Since the circuit diagram is a standard one, the circuit and circuit constants may be subject to change for improvement without any notice.

##### NOTE

◆ Due improvement in performance, some part numbers show in the circuit diagram may not agree with those indicated in the part list.



When ordering parts, please use the numbers that appear in the Parts List.

# CONTENTS

<b>SEMICONDUCTOR SHAPES .....</b>	<b>2-2</b>
<b>USING P.W. BOARD .....</b>	<b>2-2</b>
<b>BLOCK DIAGRAM .....</b>	<b>2-3</b>
<b>CIRCUIT DIAGRAMS</b>	
<b>MAIN PWB CIRCUIT DIAGRAM[AV-21TMG4/G, AV-21TMG4/S](1/3) .....</b>	<b>2-5</b>
<b>MAIN PWB CIRCUIT DIAGRAM[AV-21TMG4/G, AV-21TMG4/S](2/3),(3/3) .....</b>	<b>2-7</b>
<b>MAIN PWB CIRCUIT DIAGRAM[AV-2104T/E](1/3) .....</b>	<b>2-9</b>
<b>MAIN PWB CIRCUIT DIAGRAM[AV-2104T/E](2/3),(3/3) .....</b>	<b>2-11</b>
<b>PATTERN DIAGRAMS</b>	
<b>MAIN PWB PATTERN .....</b>	<b>2-13</b>
<b>VOLTAGE CHART .....</b>	<b>2-15</b>
<b>WAVEFORMS .....</b>	<b>2-16</b>

## SEMICONDUCTOR SHAPES

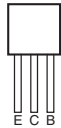
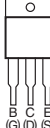
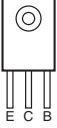
### TRANSISTOR

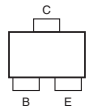
BOTTOM VIEW	FRONT VIEW				TOP VIEW
					CHIP TR 

### IC

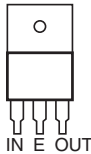
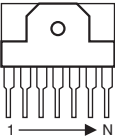
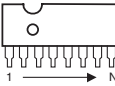
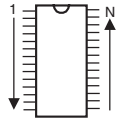
BOTTOM VIEW	FRONT VIEW			TOP VIEW
				

### CHIP IC

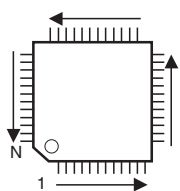
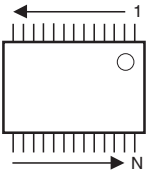
TOP VIEW		
		

## USING P.W. BOARD

P.W. BOARD ASS'Y NAME	AV-21TMG4/G	AV-21TMG4/S	AV-2104T/E
MAIN P.W. BOARD	SCW-1335A-H2	SCW-1337A-H2	SCW-1338A-H2

# BLOCK DIAGRAM

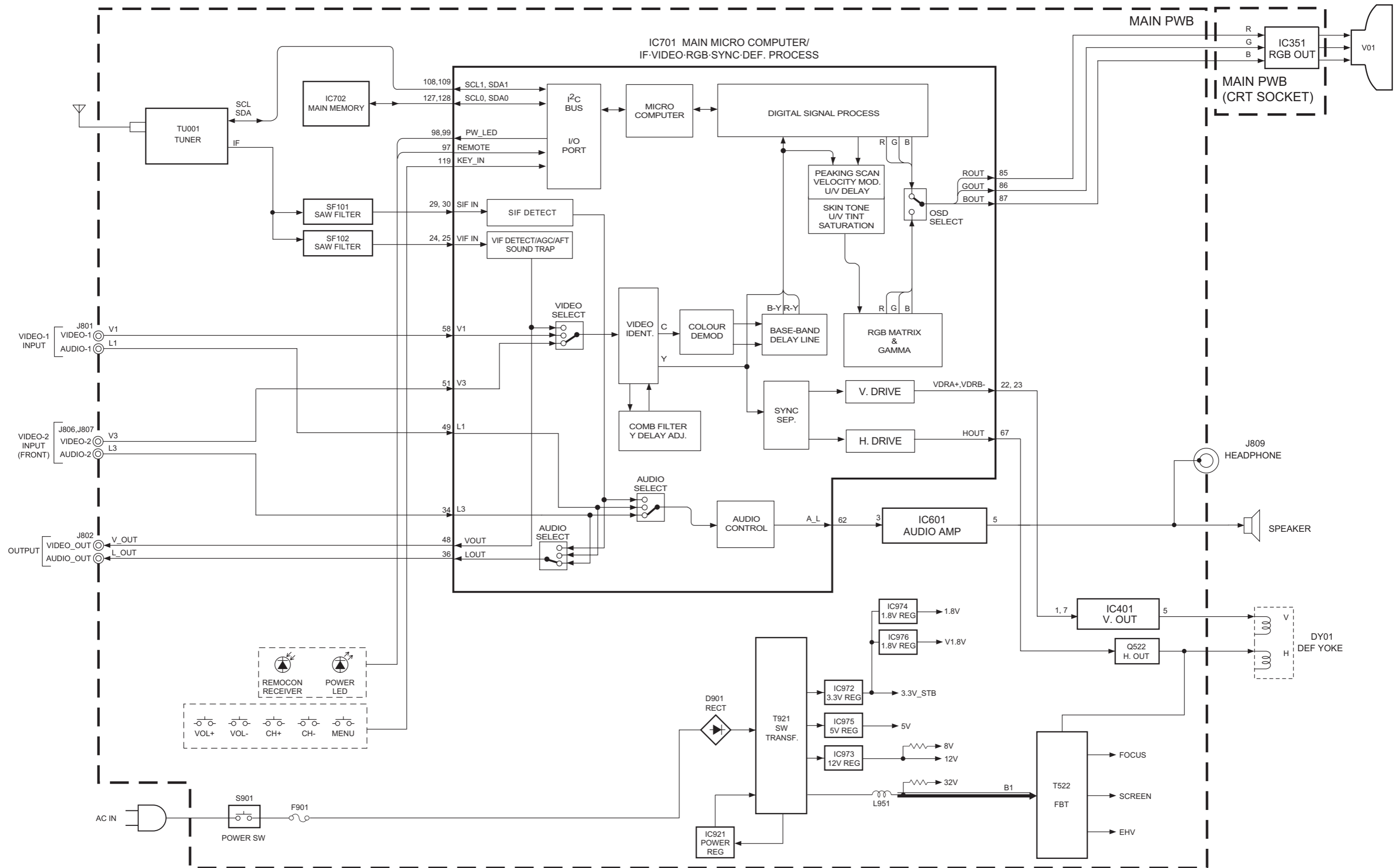



MAIN PWB CIRCUIT DIAGRAM [AV-21TMG4/G, AV-21TMG4/S] (2/3), (3/3)

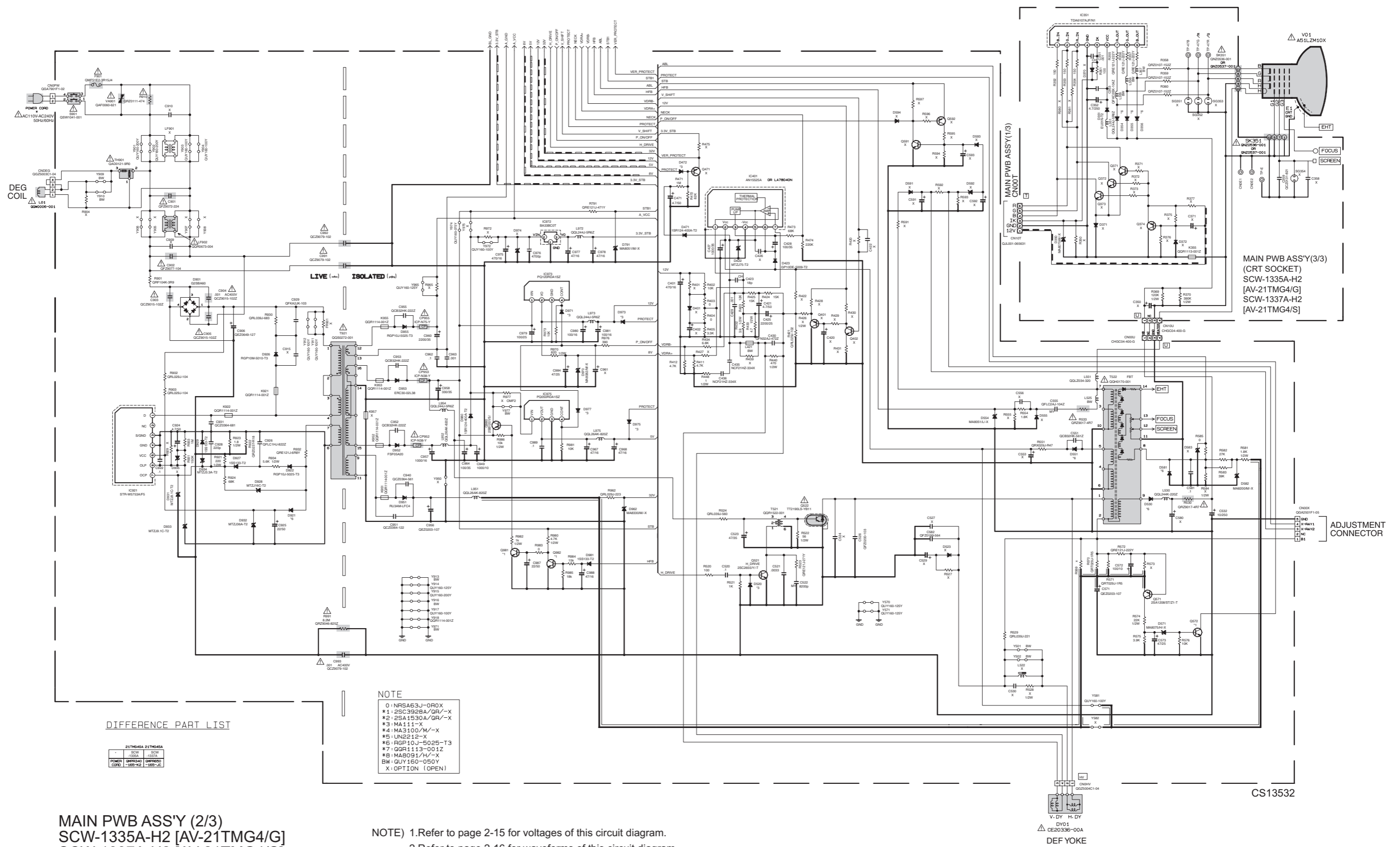

NOTE) 1.Refer to page 2-15 for voltages of this circuit diagram.  
 2.Refer to page 2-16 for waveforms of this circuit diagram.



MAIN PWB CIRCUIT DIAGRAM [AV-2104T/E] (1/3)

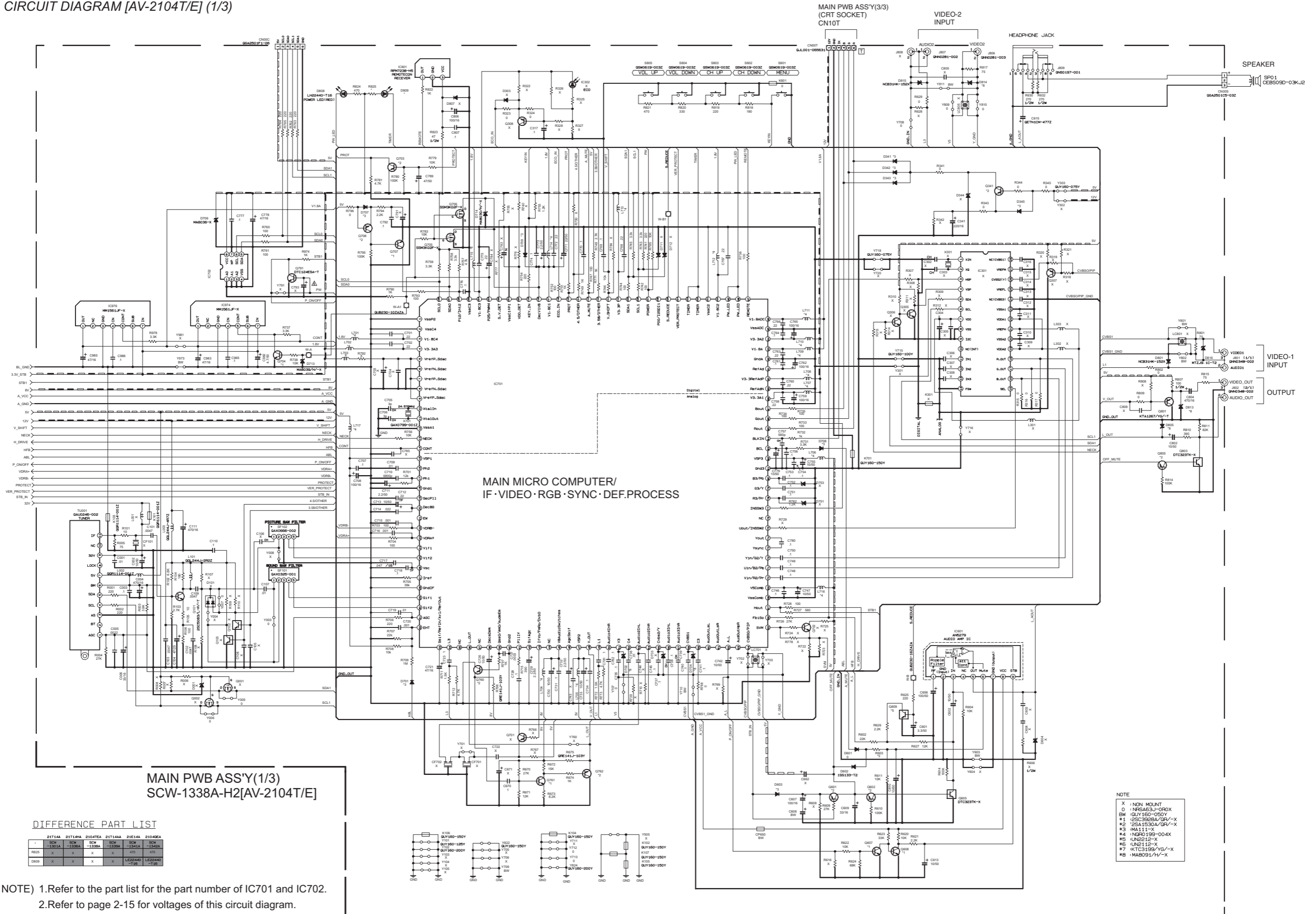

DIFFERENCE PART LIST

	S114A	S114HA	S104TEA	S114AA	S1E14A	S104EA
R101	X	X	X	X	X	X
R102	X	X	X	X	X	X
R103	X	X	X	X	X	X
R104	X	X	X	X	X	X
R105	X	X	X	X	X	X
R106	X	X	X	X	X	X
R107	X	X	X	X	X	X
R108	X	X	X	X	X	X
R109	X	X	X	X	X	X
R110	X	X	X	X	X	X
R111	X	X	X	X	X	X
R112	X	X	X	X	X	X
R113	X	X	X	X	X	X
R114	X	X	X	X	X	X
R115	X	X	X	X	X	X
R116	X	X	X	X	X	X
R117	X	X	X	X	X	X
R118	X	X	X	X	X	X
R119	X	X	X	X	X	X
R120	X	X	X	X	X	X
R121	X	X	X	X	X	X
R122	X	X	X	X	X	X
R123	X	X	X	X	X	X
R124	X	X	X	X	X	X
R125	X	X	X	X	X	X
R126	X	X	X	X	X	X
R127	X	X	X	X	X	X
R128	X	X	X	X	X	X
R129	X	X	X	X	X	X
R130	X	X	X	X	X	X
R131	X	X	X	X	X	X
R132	X	X	X	X	X	X
R133	X	X	X	X	X	X
R134	X	X	X	X	X	X
R135	X	X	X	X	X	X
R136	X	X	X	X	X	X
R137	X	X	X	X	X	X
R138	X	X	X	X	X	X
R139	X	X	X	X	X	X
R140	X	X	X	X	X	X
R141	X	X	X	X	X	X
R142	X	X	X	X	X	X
R143	X	X	X	X	X	X
R144	X	X	X	X	X	X
R145	X	X	X	X	X	X
R146	X	X	X	X	X	X
R147	X	X	X	X	X	X
R148	X	X	X	X	X	X
R149	X	X	X	X	X	X
R150	X	X	X	X	X	X
R151	X	X	X	X	X	X
R152	X	X	X	X	X	X
R153	X	X	X	X	X	X
R154	X	X	X	X	X	X
R155	X	X	X	X	X	X
R156	X	X	X	X	X	X
R157	X	X	X	X	X	X
R158	X	X	X	X	X	X
R159	X	X	X	X	X	X
R160	X	X	X	X	X	X
R161	X	X	X	X	X	X
R162	X	X	X	X	X	X
R163	X	X	X	X	X	X
R164	X	X	X	X	X	X
R165	X	X	X	X	X	X
R166	X	X	X	X	X	X
R167	X	X	X	X	X	X
R168	X	X	X	X	X	X
R169	X	X	X	X	X	X
R170	X	X	X	X	X	X
R171	X	X	X	X	X	X
R172	X	X	X	X	X	X
R173	X	X	X	X	X	X
R174	X	X	X	X	X	X
R175	X	X	X	X	X	X
R176	X	X	X	X	X	X
R177	X	X	X	X	X	X
R178	X	X	X	X	X	X
R179	X	X	X	X	X	X
R180	X	X	X	X	X	X
R181	X	X	X	X	X	X
R182	X	X	X	X	X	X
R183	X	X	X	X	X	X
R184	X	X	X	X	X	X
R185	X	X	X	X	X	X
R186	X	X	X	X	X	X
R187	X	X	X	X	X	X
R188	X	X	X	X	X	X
R189	X	X	X	X	X	X
R190	X	X	X	X	X	X
R191	X	X	X	X	X	X
R192	X	X	X	X	X	X
R193	X	X	X	X	X	X
R194	X	X	X	X	X	X
R195	X	X	X	X	X	X
R196	X	X	X	X	X	X
R197	X	X	X	X	X	X
R198	X	X	X	X	X	X
R199	X	X	X	X	X	X
R200	X	X	X	X	X	X

NOTE  
 X : NON MOUNT  
 0 : NRSAB3-OR0X  
 BW : QLY160-050Y  
 #1 : 2SC3928A/GR/-X  
 #2 : 2SA1530A/GR/-X  
 #3 : MA111-X  
 #4 : NRS013E-004X  
 #5 : UN2212-X  
 #6 : UN212-X  
 #7 : KTC1395/YG/-X  
 #8 : MAB091/V/-X

(NOTE) 1.Refer to the part list for the part number of IC701 and IC702.  
 2.Refer to page 2-15 for voltages of this circuit diagram.  
 3.Refer to page 2-16 for waveforms of this circuit diagram.





**PATTERN DIAGRAMS**  
MAIN PWB PATTERN

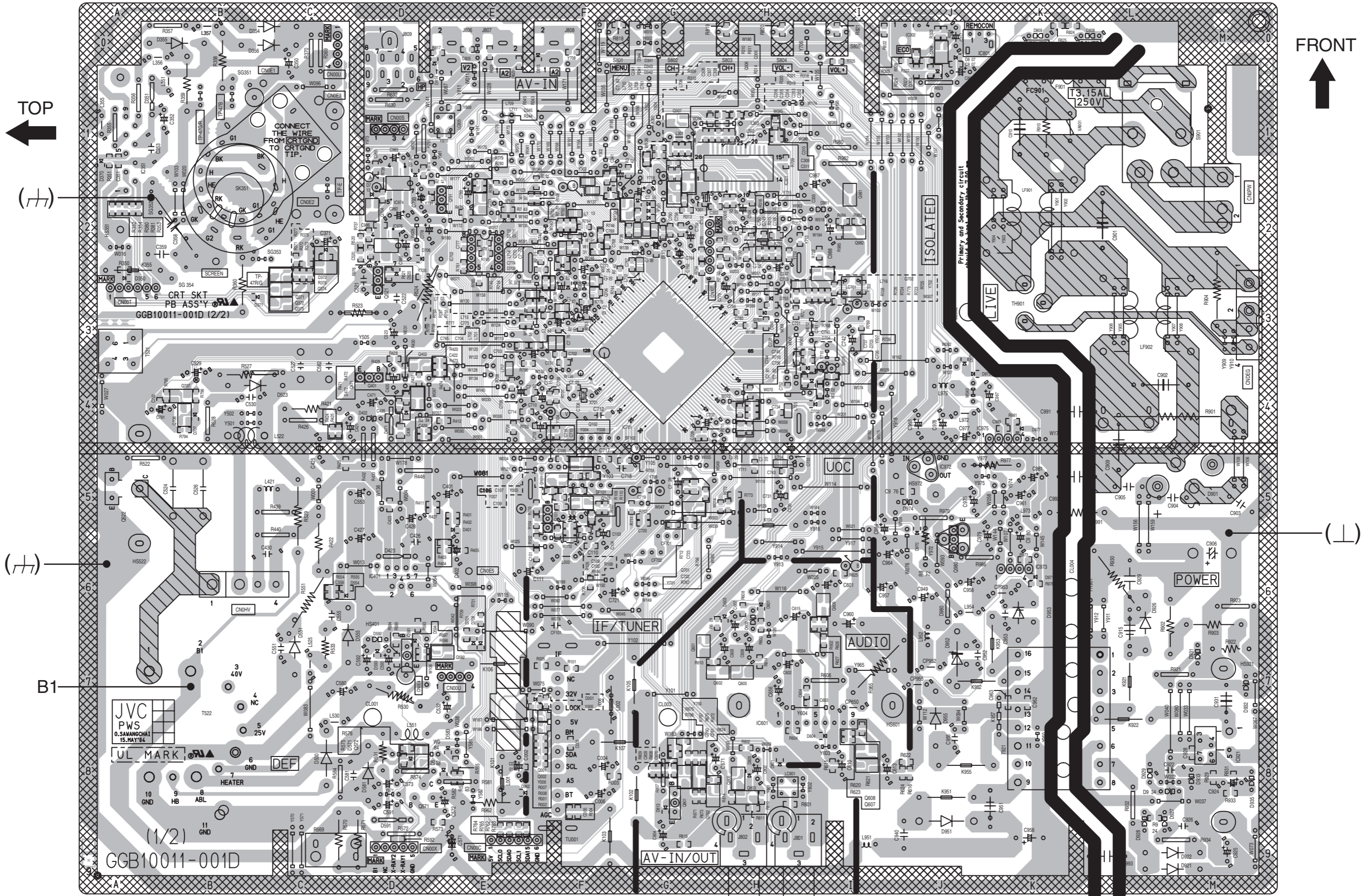



# VOLTAGE CHARTS

<MAIN PWB>

PIN NO.	VOLTAGE(V)
IC401	
1	0.5
2	14.3
3	-11.9
4	-13.6
5	0
6	14.5
7	0.5
IC601	
1	0
2	0
3	19.0
4	0
5	0
6	0
7	9.4
8	2.2
9	0
10	20.1
11	13.7
12	9.4
IC701	
1	0.1
2	0.1
3	1.8
4	3.2
5	0.1
6	0.7
7	3.1
8	0.7
9	3.1
10	0.3
11	0.3
12	0.1
13	0.1
14	2.9
15	4.9
16	0.2
17	2.4
18	0
19	2.3
20	2.3
21	0.1
22	0.9
23	0.9
24	2.0
25	0.1
26	2.4
27	1.8
28	0.1
29	0.1
30	1.9
31	2.8
32	3.3
33	1.2
34	2.2
35	2.1
36	2.7
37	0.1
38	2.3
39	2.3
40	0
41	2.0
42	1.7
43	2.1
44	0
45	8.4
46	1.7
47	4.9
48	0
49	2.2
50	2.2
51	1.3
52	1.5
53	2.2
54	2.2
55	0
56	2.2
57	2.2
58	1.7
59	0
60	2.8
61	2.7
62	0
63	3.6
64	0
65	2.0
66	0
67	0
68	0
69	4.9
70	0
71	1.2
72	0
73	0

PIN NO.	VOLTAGE(V)
74	0
75	0
76	0
77	0
78	0
79	1.2
80	0
81	0
82	0
83	0.1
84	0
85	0
86	0
87	0
88	0
89	0
90	3.2
91	0
92	0
93	0
94	3.2
95	0
96	1.8
97	3.2
98	0
99	0
100	0
101	0.1
102	3.2
103	3.2
104	1.1
105	0
106	0
107	0
108	1.8
109	1.7
110	3.2
111	0
112	0
113	2.9
114	3.2
115	0
116	0
117	1.8
118	1.8
119	3.2
120	0.9
121	0
122	1.0
123	0
124	1.8
125	0
126	3.2
127	3.0
128	3.0
IC702	
1	0
2	0
3	0
4	0
5	3.0
6	3.0
7	0
8	3.2
IC801	
1	3.1
2	3.2
3	0
IC921	
1	301.1
3	0
4	20.1
5	0.2
6	1.3
7	0.9
IC951	
1	115.4
2	13.1
3	0
IC972	
1	0
2	6.1
3	3.3
IC973	
1	15.8
2	12.0
3	0
4	3.9
IC974	
1	1.8
2	0.5
3	0.5
4	0.5
5	2.9
6	0

PIN NO.	VOLTAGE(V)
7	3.2
IC975	
1	6.1
2	5.0
3	0
4	4.0
IC976	
1	1.8
2	0.4
3	0
4	0.5
5	2.9
6	0
7	3.2
Q101	
E	2.3
C	12.0
B	3.0
Q102	
E	0
C	0
B	3.0
Q103	
E	0
C	0
B	3.1
Q521	
E	0
C	10.8
B	0
Q522	
E	0
C	111
B	-0.1
Q571	
E	115.4
C	115.1
B	43.3
Q572	
E	0.1
C	3.2
B	0
Q601	
E	0
C	0.2
B	8.3
Q602	
E	0.2
C	-0.5
B	0
Q603	
E	0
C	0
B	-0.5
Q605	
E	0
C	0
B	-0.5
Q607	
E	0
C	0
B	0.6
Q608	
E	0
C	15.0
B	0
Q703	
E	3.2
C	0
B	3.2
Q705	
S	0
G	0.8
D	1.8
Q791	
E	0
C	4.8
B	0
Q801	
E	1.9
C	0
B	1.3
Q803	
E	0.1
C	0
B	-0.6
Q804	
E	0
C	0
B	-0.7
Q805	
E	0.2
C	-0.6
B	0

PIN NO.	VOLTAGE(V)
Q955	
E	0
C	12.0
B	0
TU001	
1 (AGC)	2.9
2	0
3	0
4	2.0
5	1.9
6	4.9
7	4.9
8	0
9	33.8
11	0

<MAIN PWB (CRT SOCKET)>

PIN NO.	VOLTAGE(V)
IC351	
1	1.8
2	1.8
3	1.8
4	0
5	4.1
6	209.3
7	142.3
8	144.8
9	145.6

# WAVEFORMS

## -MAIN PWB-

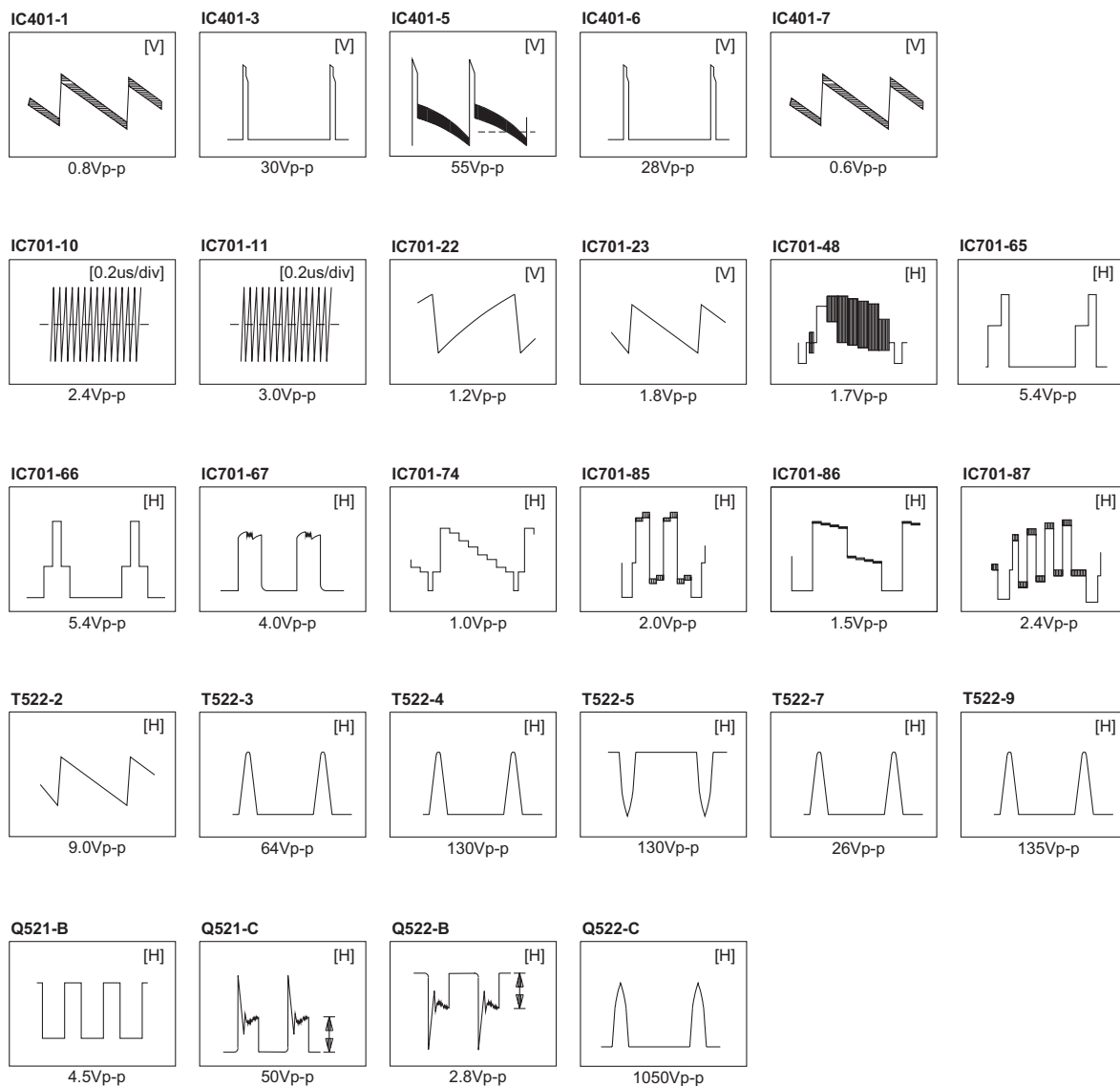

## -CRT SOCKET PWB-

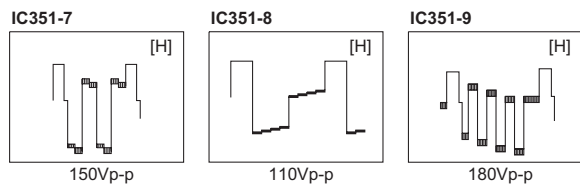





# JVC

Victor Company of Japan, Limited

AV & MULTIMEDIA COMPANY VIDEO DISPLAY CATEGORY 12, 3-chome, Moriya-cho, kanagawa-ku, Yokohama, kanagawa-prefecture, 221-8528, Japan

(No.YA129)



Printed in Japan  
WPC