



Internal Use Only

Website: <http://biz.LGservice.com>

# COLOR MONITOR SERVICE MANUAL

CHASSIS NO. : LM57B

MODEL: FLATRON L1733TR (L1733TR-SFQ.A\*\*MQP)

FLATRON L1933TR (L1933TR-SFQ.A\*\*MQP,A\*\*RQP)

( ) \*\*Same model for Service

## CAUTION

BEFORE SERVICING THE UNIT,  
READ THE SAFETY PRECAUTIONS IN THIS MANUAL.



\*To apply the **MSTAR Chip**.

# CONTENTS

SPECIFICATIONS .....	2	SERVICE OSD .....	17
PRECAUTIONS .....	3	TROUBLESHOOTING GUIDE .....	18
TIMING CHART .....	7	WIRING DIAGRAM .....	24
DISASSEMBLY .....	8	EXPLODED VIEW .....	25
BLOCK DIAGRAM.....	12	REPLACEMENT PARTS LIST .....	27
DISCRIPTION OF BLOCK DIAGRAM .....	14	SCHEMATIC DIAGRAM.....	31
ADJUSTMENT .....	16		

## SPECIFICATIONS

### 1. LCD CHARACTERISTICS

Type : TFT Color LCD Module  
 Active Display Area : 17 inch - **L1733T**  
                                   : 19 inch - **L1933T**  
 Pixel Pitch : 0.264 (H) x 0.264 (V) - **L1733T**  
                                   : 0.294 (H) x 0.294 (V) - **L1933T**  
 Color Depth : 8bits, 16.2M colors  
 Size : 358.5 (H) x 296.5 (V) x 17.0(D) - **L1733T**  
        : 396 (H) x 324 (V) x 17.5(D) - **L1933T**  
 Electrical Interface : LVDS  
 Surface Treatment : Hard-coating(3H), Anti-Glare  
 Operating Mode : Normally White, Transmissive mode  
 Backlight Unit : 4-CCFL

### 2. OPTICAL CHARACTERISTICS

2-1. Viewing Angle by Contrast Ratio  $\geq 10$

Left : -60° min., -70°(Typ)   Right : +60° min., +70°(Typ)  
 Top : +60° min., +75°(Typ)   Bottom : -50° min., -65°(Typ)

2-2. Luminance : 230(min), 300(Typ) (Full White pattern, 0.70V) -**6500K**  
                   : 150(min) (Full White pattern, 0.70V) -**9300K**  
                                   75%(min)

2-3. Contrast Ratio : 1400:1 (DFC)

### 3. SIGNAL (Refer to the Timing Chart)

3-1. Sync Signal  
 • Type : Separate Sync, Digital, SOG

3-2. Video Input Signal  
 1) Type : R, G, B Analog  
 2) Voltage Level : 0~0.71 V  
    a) Color 0, 0 : 0 Vp-p  
    b) Color 7, 0 : 0.467Vp-p  
    c) Color 15, 0 : 0.714Vp-p  
 3) Input Impedance : 75 $\Omega$

3-3. Operating Frequency  
 Horizontal : 30 ~ 83kHz  
 Vertical : 56 ~ 75Hz

### 4. Max. Resolution

D-sub Analog : 1280 x 1024@75Hz  
 Digital : 1280 x 1024@60Hz

### 5. POWER SUPPLY

5-1. Power : AC 100~240V, 50/60Hz , 0.6A

5-2. Power Consumption

MODE	H/V SYNC	VIDEO	POWER CONSUMPTION	LED COLOR
POWER ON (NORMAL)	ON/ON	ACTIVE	less than 33 W - <b>L1733T</b>	BLUE or GREEN
			less than 37 W - <b>L1933T</b>	
STAND-BY	OFF/ON	OFF	less than 1 W	AMBER
SUSPEND	ON/OFF	OFF	less than 1 W	AMBER
DPMS OFF	OFF/OFF	OFF	less than 1 W	AMBER
POWER S/W Off	-	-	less than 1 W	OFF

### 6. ENVIRONMENT

6-1. Operating Temperature : 10°C~35°C (50°F~95°F)  
   (Ambient)

6-2. Relative Humidity : 10%~80% (Non-condensing)

6-3. MTBF : 50,000 HRS with 90% Confidence  
        Lamp Life : 50,000 Hours(Min)

### 7. DIMENSIONS (with TILT/SWIVEL)

**L1733T**  
 Width : 364.5 mm (14.35")  
 Depth : 180 mm (7.09")  
 Height : 378.2 mm (14.89")

**L1933T**  
 Width : 402 mm (15.83")  
 Depth : 180 mm (7.09")  
 Height : 407.5 mm (16.04")

### 8. WEIGHT (with TILT/SWIVEL)

**L1733T**  
 Net. Weight : 3.5 kg (7.72 lbs)  
 Gross Weight : 4.6 kg (10.14 lbs)

**L1933T**  
 Net. Weight : 4.4 kg (9.70 lbs)  
 Gross Weight : 5.6 kg (12.35 lbs)

## PRECAUTION

### WARNING FOR THE SAFETY-RELATED COMPONENT.

- There are some special components used in LCD monitor that are important for safety. **These parts are marked  $\triangle$  on the schematic diagram and the replacement parts list.** It is essential that these critical parts should be replaced with the manufacturer's specified parts to prevent electric shock, fire or other hazard.
- Do not modify original design without obtaining written permission from manufacturer or you will void the original parts and labor guarantee.

### TAKE CARE DURING HANDLING THE LCD MODULE WITH BACKLIGHT UNIT.

- Must mount the module using mounting holes arranged in four corners.
- Do not press on the panel, edge of the frame strongly or electric shock as this will result in damage to the screen.
- Do not scratch or press on the panel with any sharp objects, such as pencil or pen as this may result in damage to the panel.
- Protect the module from the ESD as it may damage the electronic circuit (C-MOS).
- Make certain that treatment person's body are grounded through wrist band.
- Do not leave the module in high temperature and in areas of high humidity for a long time.
- The module not be exposed to the direct sunlight.
- Avoid contact with water as it may a short circuit within the module.
- If the surface of panel become dirty, please wipe it off with a softmaterial. (Cleaning with a dirty or rough cloth may damage the panel.)

### $\triangle$ CAUTION

Please use only a plastic screwdriver to protect yourself from shock hazard during service operation.

### $\triangle$ WARNING

BE CAREFUL ELECTRIC SHOCK !

- If you want to replace with the new backlight (CCFL) or inverter circuit, must disconnect the AC adapter because high voltage appears at inverter circuit about 650Vrms.
- Handle with care wires or connectors of the inverter circuit. If the wires are pressed cause short and may burn or take fire.

### Leakage Current Hot Check Circuit

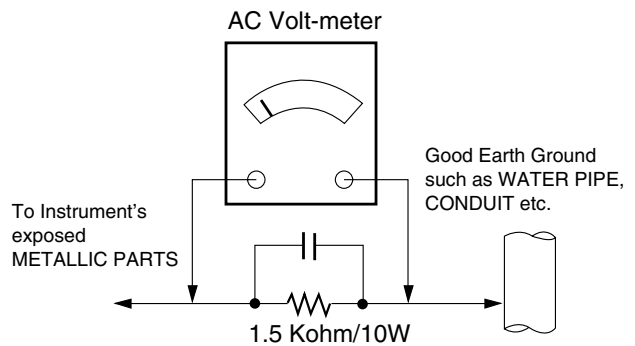

# SERVICING PRECAUTIONS

**CAUTION:** Before servicing receivers covered by this service manual and its supplements and addenda, read and follow the **SAFETY PRECAUTIONS** on page 3 of this publication.

**NOTE:** If unforeseen circumstances create conflict between the following servicing precautions and any of the safety precautions on page 3 of this publication, always follow the safety precautions. Remember: Safety First.

## General Servicing Precautions

1. Always unplug the receiver AC power cord from the AC power source before;
  - a. Removing or reinstalling any component, circuit board module or any other receiver assembly.
  - b. Disconnecting or reconnecting any receiver electrical plug or other electrical connection.
  - c. Connecting a test substitute in parallel with an electrolytic capacitor in the receiver.  
**CAUTION:** A wrong part substitution or incorrect polarity installation of electrolytic capacitors may result in an explosion hazard.
  - d. Discharging the picture tube anode.
2. Test high voltage only by measuring it with an appropriate high voltage meter or other voltage measuring device (DVM, FETVOM, etc) equipped with a suitable high voltage probe.  
Do not test high voltage by "drawing an arc".
3. Discharge the picture tube anode only by (a) first connecting one end of an insulated clip lead to the degaussing or kine aquadag grounding system shield at the point where the picture tube socket ground lead is connected, and then (b) touch the other end of the insulated clip lead to the picture tube anode button, using an insulating handle to avoid personal contact with high voltage.
4. Do not spray chemicals on or near this receiver or any of its assemblies.
5. Unless specified otherwise in this service manual, clean electrical contacts only by applying the following mixture to the contacts with a pipe cleaner, cotton-tipped stick or comparable non-abrasive applicator; 10% (by volume) Acetone and 90% (by volume) isopropyl alcohol (90%-99% strength)  
**CAUTION:** This is a flammable mixture.  
Unless specified otherwise in this service manual, lubrication of contacts is not required.
6. Do not defeat any plug/socket B+ voltage interlocks with which receivers covered by this service manual might be equipped.
7. Do not apply AC power to this instrument and/or any of its electrical assemblies unless all solid-state device heat sinks are correctly installed.
8. Always connect the test receiver ground lead to the receiver chassis ground before connecting the test receiver positive lead.  
Always remove the test receiver ground lead last.

9. Use with this receiver only the test fixtures specified in this service manual.

**CAUTION:** Do not connect the test fixture ground strap to any heat sink in this receiver.

## Electrostatically Sensitive (ES) Devices

Some semiconductor (solid-state) devices can be damaged easily by static electricity. Such components commonly are called *Electrostatically Sensitive (ES) Devices*. Examples of typical ES devices are integrated circuits and some field-effect transistors and semiconductor "chip" components. The following techniques should be used to help reduce the incidence of component damage caused by static by static electricity.

1. Immediately before handling any semiconductor component or semiconductor-equipped assembly, drain off any electrostatic charge on your body by touching a known earth ground. Alternatively, obtain and wear a commercially available discharging wrist strap device, which should be removed to prevent potential shock reasons prior to applying power to the unit under test.
2. After removing an electrical assembly equipped with ES devices, place the assembly on a conductive surface such as aluminum foil, to prevent electrostatic charge buildup or exposure of the assembly.
3. Use only a grounded-tip soldering iron to solder or unsolder ES devices.
4. Use only an anti-static type solder removal device. Some solder removal devices not classified as "anti-static" can generate electrical charges sufficient to damage ES devices.
5. Do not use freon-propelled chemicals. These can generate electrical charges sufficient to damage ES devices.
6. Do not remove a replacement ES device from its protective package until immediately before you are ready to install it. (Most replacement ES devices are packaged with leads electrically shorted together by conductive foam, aluminum foil or comparable conductive material).
7. Immediately before removing the protective material from the leads of a replacement ES device, touch the protective material to the chassis or circuit assembly into which the device will be installed.  
**CAUTION:** Be sure no power is applied to the chassis or circuit, and observe all other safety precautions.
8. Minimize bodily motions when handling unpackaged replacement ES devices. (Otherwise harmless motion such as the brushing together of your clothes fabric or the lifting of your foot from a carpeted floor can generate static electricity sufficient to damage an ES device.)

## General Soldering Guidelines

1. Use a grounded-tip, low-wattage soldering iron and appropriate tip size and shape that will maintain tip temperature within the range of 500°F to 600°F.
2. Use an appropriate gauge of RMA resin-core solder composed of 60 parts tin/40 parts lead.
3. Keep the soldering iron tip clean and well tinned.
4. Thoroughly clean the surfaces to be soldered. Use a small wire-bristle (0.5 inch, or 1.25cm) brush with a metal handle.

Do not use freon-propelled spray-on cleaners.

5. Use the following unsoldering technique
  - a. Allow the soldering iron tip to reach normal temperature.  
(500°F to 600°F)
  - b. Heat the component lead until the solder melts.
  - c. Quickly draw the melted solder with an anti-static, suction-type solder removal device or with solder braid.

**CAUTION:** Work quickly to avoid overheating the circuitboard printed foil.

6. Use the following soldering technique.
  - a. Allow the soldering iron tip to reach a normal temperature (500°F to 600°F)
  - b. First, hold the soldering iron tip and solder the strand against the component lead until the solder melts.
  - c. Quickly move the soldering iron tip to the junction of the component lead and the printed circuit foil, and hold it there only until the solder flows onto and around both the component lead and the foil.

**CAUTION:** Work quickly to avoid overheating the circuit board printed foil.

- d. Closely inspect the solder area and remove any excess or splashed solder with a small wire-bristle brush.

## IC Remove/Replacement

Some chassis circuit boards have slotted holes (oblong) through which the IC leads are inserted and then bent flat against the circuit foil. When holes are the slotted type, the following technique should be used to remove and replace the IC. When working with boards using the familiar round hole, use the standard technique as outlined in paragraphs 5 and 6 above.

### Removal

1. Desolder and straighten each IC lead in one operation by gently prying up on the lead with the soldering iron tip as the solder melts.
2. Draw away the melted solder with an anti-static suction-type solder removal device (or with solder braid) before removing the IC.

### Replacement

1. Carefully insert the replacement IC in the circuit board.
2. Carefully bend each IC lead against the circuit foil pad and solder it.
3. Clean the soldered areas with a small wire-bristle brush. (It is not necessary to reapply acrylic coating to the areas).

## "Small-Signal" Discrete Transistor

### Removal/Replacement

1. Remove the defective transistor by clipping its leads as close as possible to the component body.
2. Bend into a "U" shape the end of each of three leads remaining on the circuit board.
3. Bend into a "U" shape the replacement transistor leads.
4. Connect the replacement transistor leads to the corresponding leads extending from the circuit board and crimp the "U" with long nose pliers to insure metal to metal contact then solder each connection.

## Power Output, Transistor Device

### Removal/Replacement

1. Heat and remove all solder from around the transistor leads.
2. Remove the heat sink mounting screw (if so equipped).
3. Carefully remove the transistor from the heat sink of the circuit board.
4. Insert new transistor in the circuit board.
5. Solder each transistor lead, and clip off excess lead.
6. Replace heat sink.

## Diode Removal/Replacement

1. Remove defective diode by clipping its leads as close as possible to diode body.
2. Bend the two remaining leads perpendicular y to the circuit board.
3. Observing diode polarity, wrap each lead of the new diode around the corresponding lead on the circuit board.
4. Securely crimp each connection and solder it.
5. Inspect (on the circuit board copper side) the solder joints of the two "original" leads. If they are not shiny, reheat them and if necessary, apply additional solder.

## Fuse and Conventional Resistor

### Removal/Replacement

1. Clip each fuse or resistor lead at top of the circuit board hollow stake.
2. Securely crimp the leads of replacement component around notch at stake top.
3. Solder the connections.

**CAUTION:** Maintain original spacing between the replaced component and adjacent components and the circuit board to prevent excessive component temperatures.

### **Circuit Board Foil Repair**

Excessive heat applied to the copper foil of any printed circuit board will weaken the adhesive that bonds the foil to the circuit board causing the foil to separate from or "lift-off" the board. The following guidelines and procedures should be followed whenever this condition is encountered.

#### ***At IC Connections***

To repair a defective copper pattern at IC connections use the following procedure to install a jumper wire on the copper pattern side of the circuit board. (Use this technique only on IC connections).

1. Carefully remove the damaged copper pattern with a sharp knife. (Remove only as much copper as absolutely necessary).
2. Carefully scratch away the solder resist and acrylic coating (if used) from the end of the remaining copper pattern.
3. Bend a small "U" in one end of a small gauge jumper wire and carefully crimp it around the IC pin. Solder the IC connection.
4. Route the jumper wire along the path of the out-away copper pattern and let it overlap the previously scraped end of the good copper pattern. Solder the overlapped area and clip off any excess jumper wire.

#### ***At Other Connections***

Use the following technique to repair the defective copper pattern at connections other than IC Pins. This technique involves the installation of a jumper wire on the component side of the circuit board.

1. Remove the defective copper pattern with a sharp knife.  
Remove at least 1/4 inch of copper, to ensure that a hazardous condition will not exist if the jumper wire opens.
2. Trace along the copper pattern from both sides of the pattern break and locate the nearest component that is directly connected to the affected copper pattern.
3. Connect insulated 20-gauge jumper wire from the lead of the nearest component on one side of the pattern break to the lead of the nearest component on the other side.

Carefully crimp and solder the connections.

**CAUTION:** Be sure the insulated jumper wire is dressed so the it does not touch components or sharp edges.

# TIMING CHART

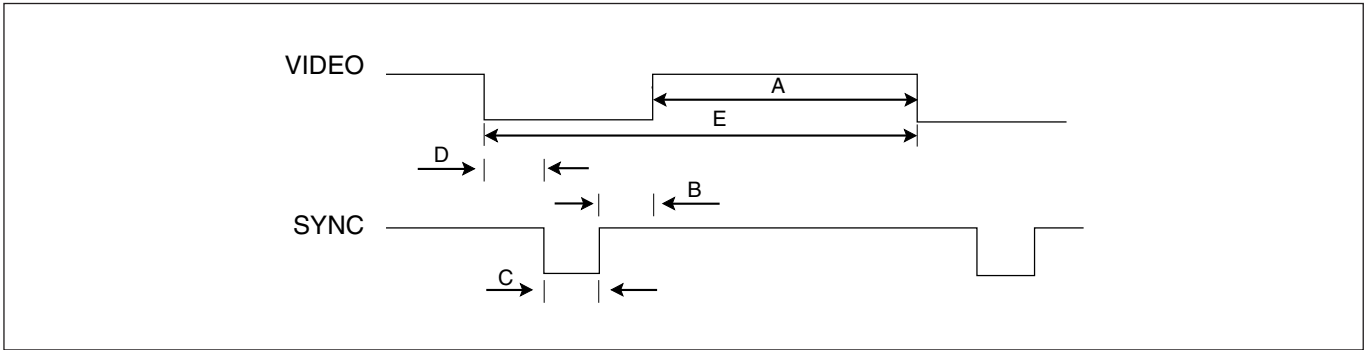

MODE	H / V	Sync Polarity	Dot Clock	Frequency	Total Period ( E )	Video Active Time ( A )	Sync Duration ( D )	Front Porch ( C )	Blanking Time ( B )	Resolution
1	H(Pixels)	+	25.175	31.469	800	640	16	96	48	640 x 350
	V(Lines)	-		70.09	449	350	37	2	60	
2	H(Pixels)	-	28.321	31.468	900	720	18	108	54	720 X 400
	V(Lines)	+		70.08	449	400	12	2	35	
3	H(Pixels)	-	25.175	31.469	800	640	16	96	48	640 x 480
	V(Lines)	-		59.94	525	480	10	2	33	
4	H(Pixels)	-	31.5	37.5	840	640	16	64	120	640 x 480
	V(Lines)	-		75	500	480	1	3	16	
5	H(Pixels)	+	40.0	37.879	1056	800	40	128	88	800 x 600
	V(Lines)	+		60.317	628	600	1	4	23	
6	H(Pixels)	+	49.5	46.875	1056	800	16	80	160	800 x 600
	V(Lines)	+		75.0	625	600	1	3	21	
7	H(Pixels)	+/-	57.283	49.725	1152	832	32	64	224	832 x 624
	V(Lines)	+/-		74.55	667	624	1	3	39	
8	H(Pixels)	-	65.0	48.363	1344	1024	24	136	160	1024 x 768
	V(Lines)	-		60.0	806	768	3	6	29	
9	H(Pixels)	-	78.75	60.123	1312	1024	16	96	176	1024 x 768
	V(Lines)	-		75.029	800	768	1	3	28	
10	H(Pixels)	+/-	100.0	68.681	1456	1152	32	128	144	1152 x 870
	V(Lines)	+/-		75.062	915	870	3	3	39	
11	H(Pixels)	+/-	92.978	61.805	1504	1152	18	134	200	1152 x 900
	V(Lines)	+/-		65.96	937	900	2	4	31	
12	H(Pixels)	+	108.0	63.981	1688	1280	48	112	248	1280 x 1024
	V(Lines)	+		60.02	1066	1024	1	3	38	
13	H(Pixels)	+	135.0	79.976	1688	1280	16	144	248	1280 x 1024
	V(Lines)	+		75.035	1066	1024	1	3	38	

## DISASSEMBLY-Set

# 1



Soft pad on the table.

# 2



Monitor on the pad.

# 3

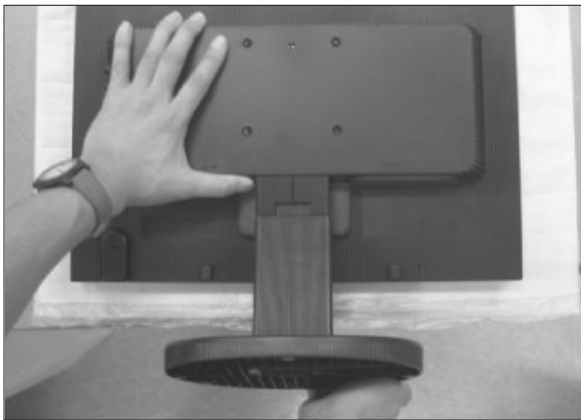

Pull up the stand part.

# 4-1

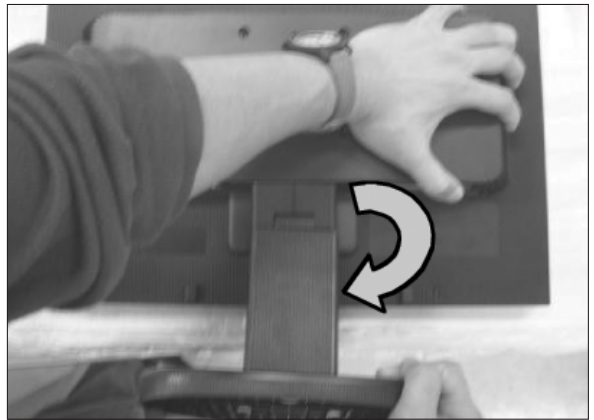

Hold the head & stand base and then  
**Twist Stand until "Click"**.

# 4-2

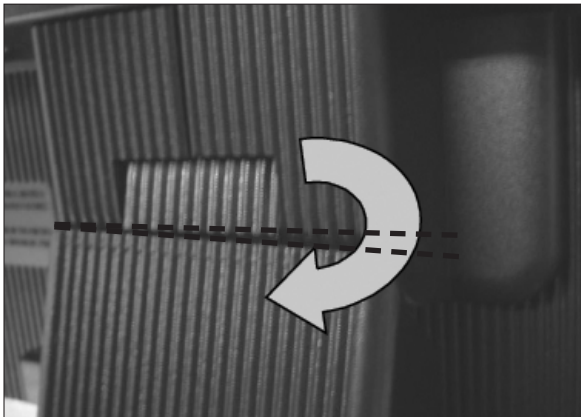

# 5



Separate head & stand



# 6

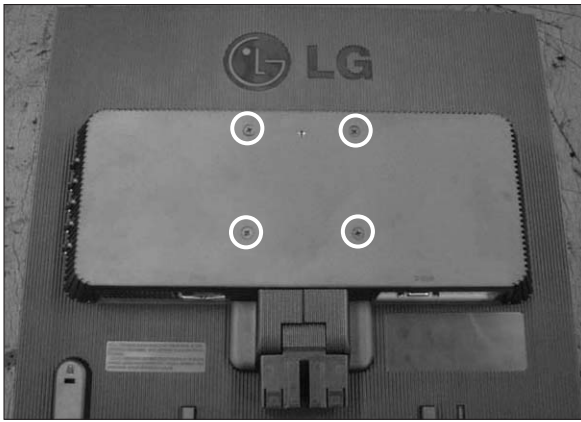

Remove the screws.

# 7



1. Pull the front cover upward.
2. Then, let the all latches are separated.(#3-1~3-2)
3. Put the front face down.

# 8



# 9

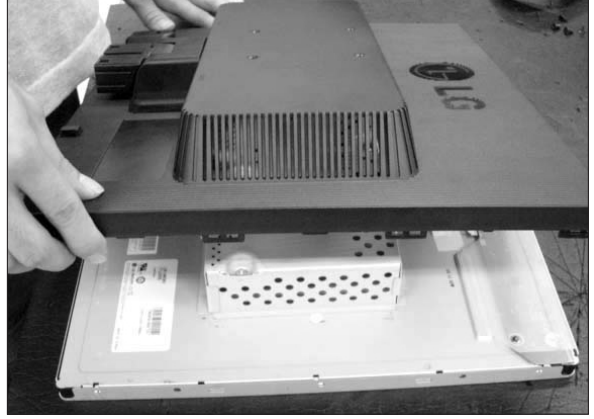

Disassemble back cover.

## DISASSEMBLY-Stand

\* In case of Latch 4.

# 1-1

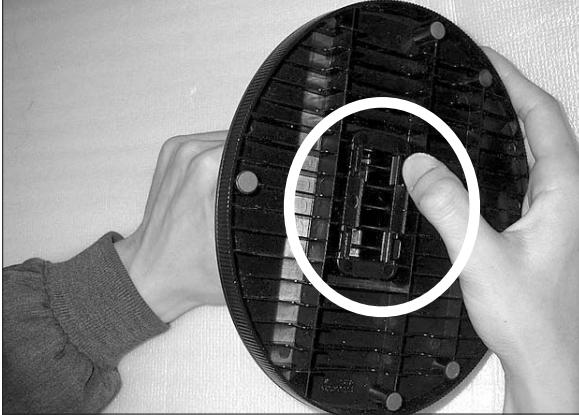

Push the four latches on the bottom to the outside and Separate Stand Body & Base.  
(Reference the #1-2)

# 1-2

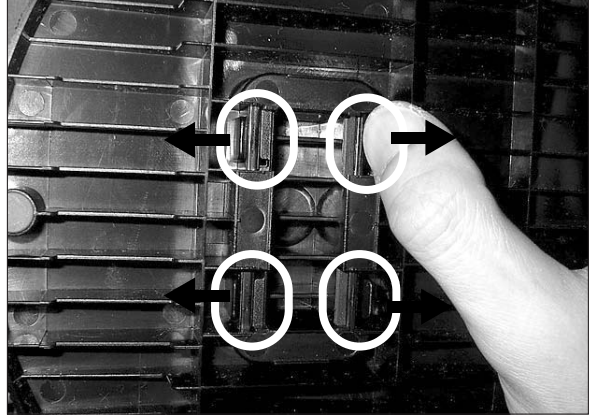

# 2

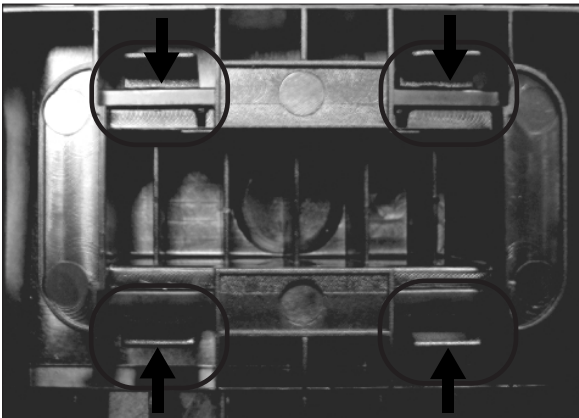

After finished repair, necessarily push 4ea Latches to inside for restoration.

# 3

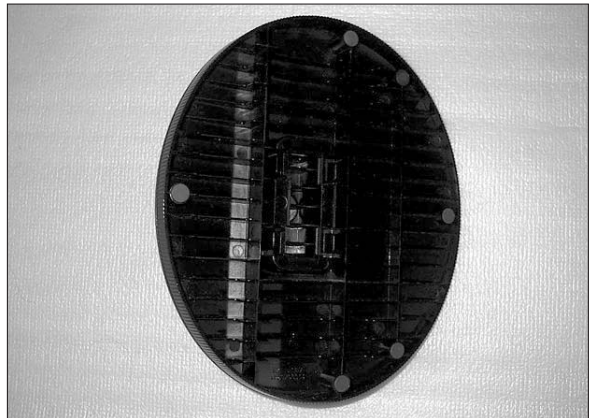

## DISASSEMBLY-Stand

\* In case of Latch 2.

# 1



Hold the stand body.

# 2

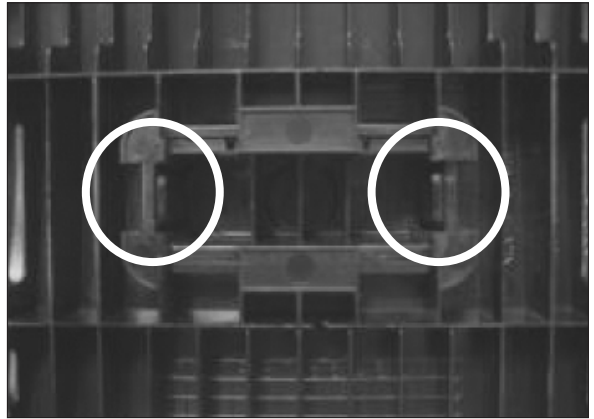

Confirm two latch of right and left.

# 3

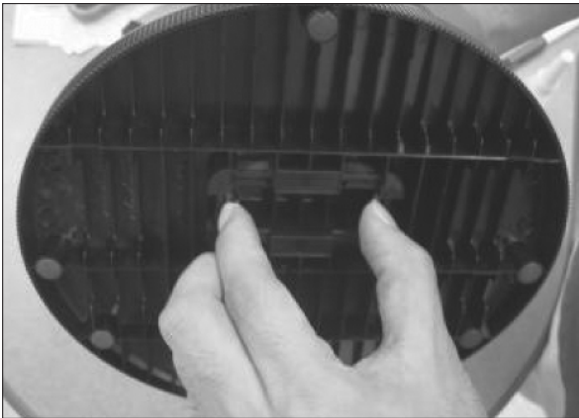

Push the latch to the inside.

# 4

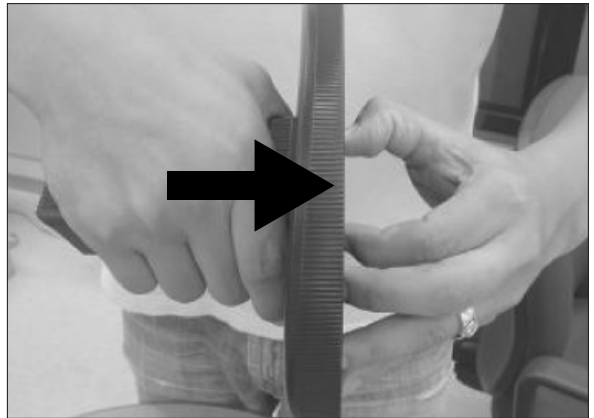

Push the base to the opposite direction.

# 5



Confirm the condition of separation.

# BLOCK DIAGRAM

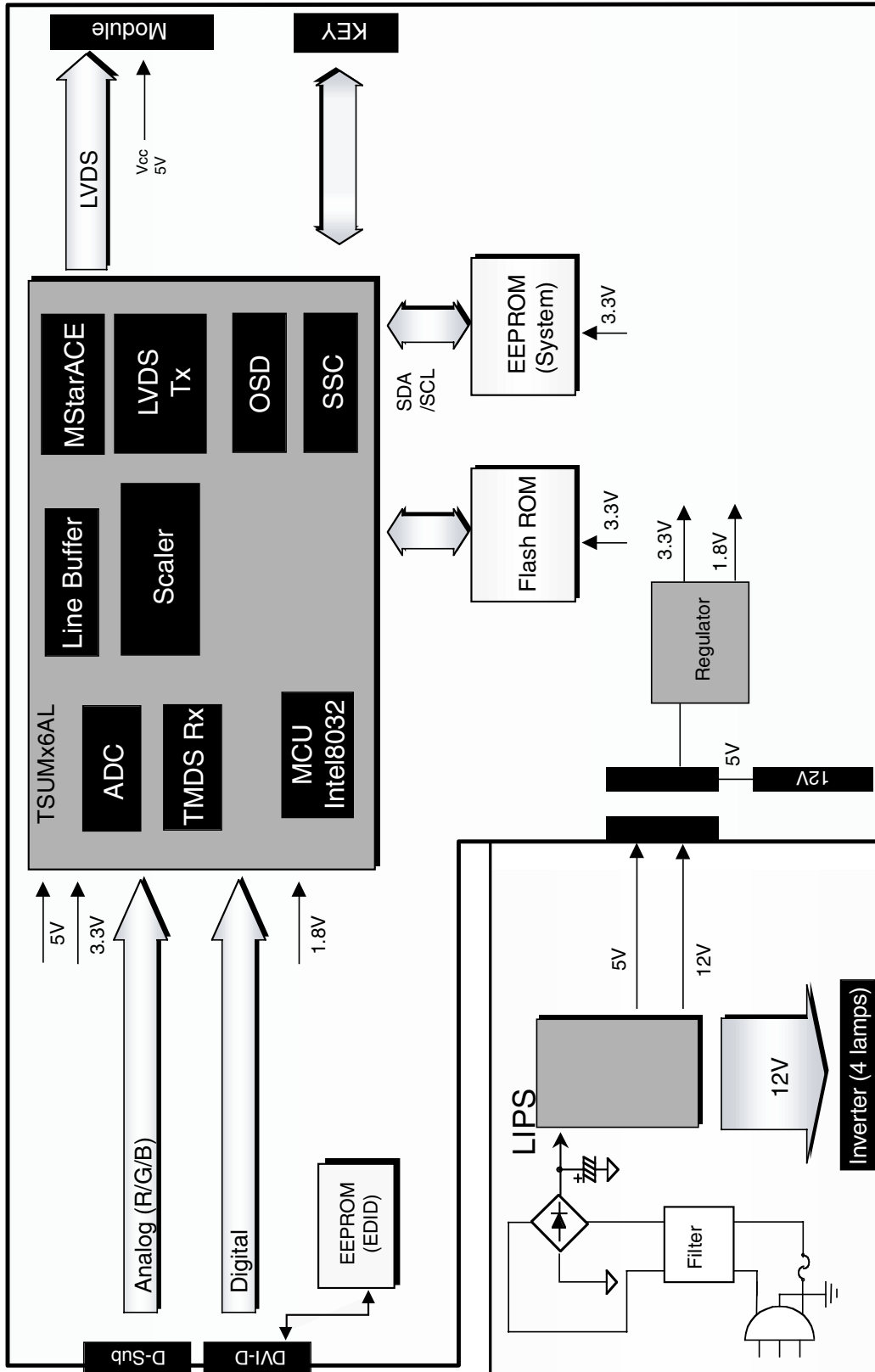

# BLOCK DIAGRAM-POWER

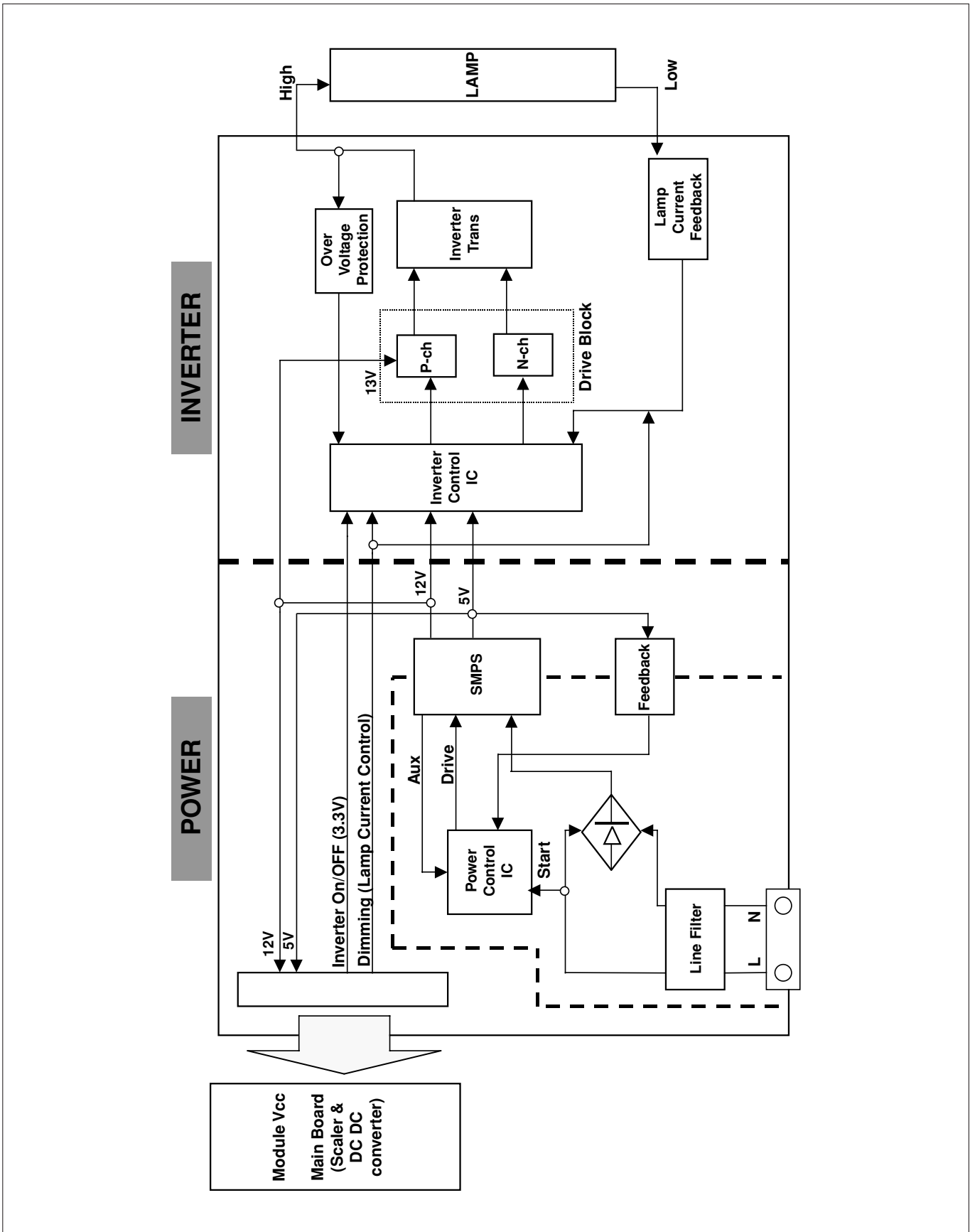

# DESCRIPTION OF BLOCK DIAGRAM

## 1. Video Controller Part.

This part amplifies the level of video signal for the digital conversion and converts from the analog video signal to the digital video signal using a pixel clock.

The pixel clock for each mode is generated by the PLL.

The range of the pixel clock is from 25MHz to 135MHz.

This part consists of the Scaler, ADC convertor, TMDS receiver and LVDS transmitter.

The Scaler gets the video signal converted analog to digital, interpolates input to 1280 X 1024 resolution signal and outputs 8-bit R, G, B signal to transmitter.

## 2. Power Part.

This part consists of the one 3.3V, and one 1.8V regulators to convert power which is provided 5V in Power board.

12V is provided for inverter, 5V is provided for LCD panel.

Also, 5V is converted 3.3V and 1.8V by regulator. Converted power is provided for IC in the main board.

The inverter converts from DC12V to AC 700Vrms and operates back-light lamps of module.

## 3. MICOM Part.

This part is include video controller part. And this part consists of EEPROM IC which stores control data, Reset IC and the Micom.

The Micom distinguishes polarity and frequency of the H/V sync are supplied from signal cable.

The controlled data of each modes is stored in EEPROM.

## LIPS Board Block Diagram

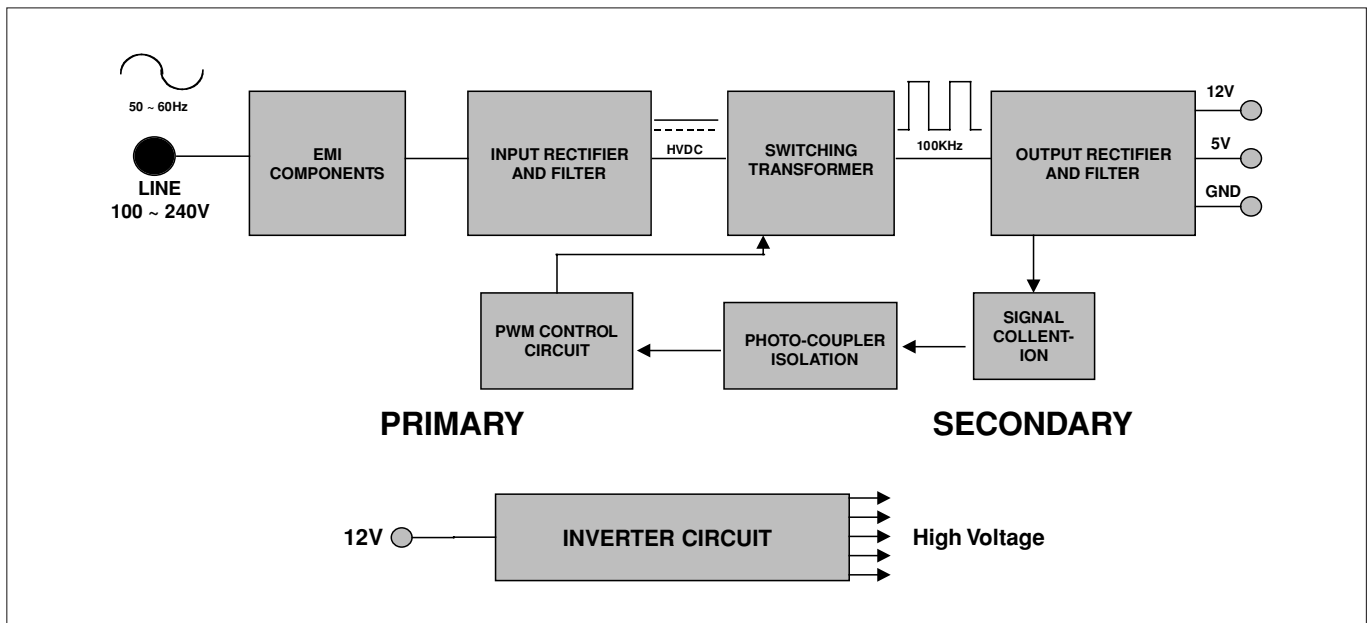

### Operation description\_LIPS

#### 1. EMI components.

This part contains of EMI components to comply with global marketing EMI standards like FCC,VCCI CISPR, the circuit included a line-filter, across line capacitor and of course the primary protection fuse.

#### 2. Input rectifier and filter.

This part function is for transfer the input AC voltage to a DC voltage through a bridge rectifier and a bulk capacitor.

#### 3. Energy Transfer.

This part function is for transfer the primary energy to secondary through a power transformer.

#### 4. Output rectifier and filter.

This part function is to make a pulse width modulation control and to provide the driver signal to power switch, to adjust the duty cycle during different AC input and output loading condition to achieve the dc output stabilized, and also the over power protection is also monitor by this part.

#### 5. Photo-Coupler isolation.

This part function is to feed back the DC output changing status through a photo transistor to primary controller to achieve the stabilized DC output voltage.

#### 6. Signal collection.

This part function is to collect the any change from the DC output and feed back to the primary through photo transistor.

# ADJUSTMENT

Windows EDID V1.0 User Manual

Operating System: MS Windows 98, 2000, XP  
 Port Setup: Windows 98 => Don't need setup  
 Windows 2000, XP => Need to Port Setup.

This program is available to LCD Monitor only.

## 1. Port Setup

- a) Copy "UserPort.sys" file to "c:\WINNT\system32\drivers" folder
- b) Run Userport.exe

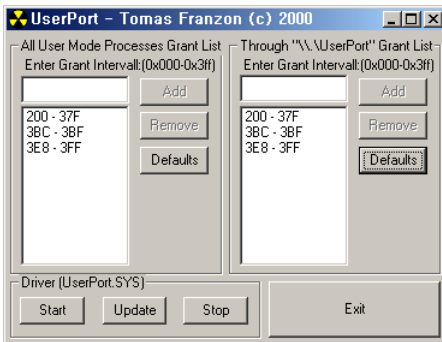

- c) Remove all default number
- d) Add 300-3FF

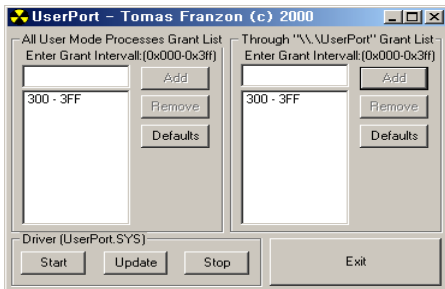

- e) Click Start button.
- f) Click Exit button.

## 2. EDID Read & Write

- 1) Run WinEDID.exe

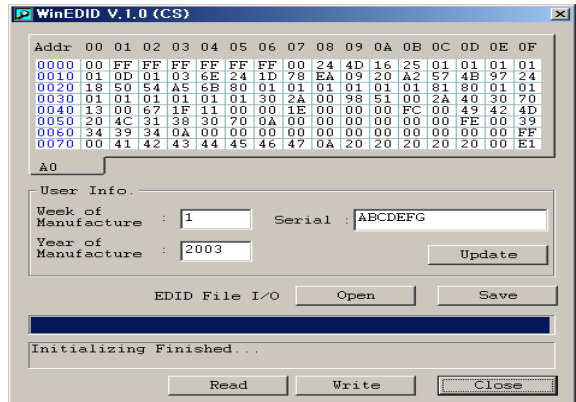

- 2) Edit Week of Manufacture, Year of Manufacture, Serial Number

- a) Input User Info Data
- b) Click "Update" button
- c) Click "Write" button

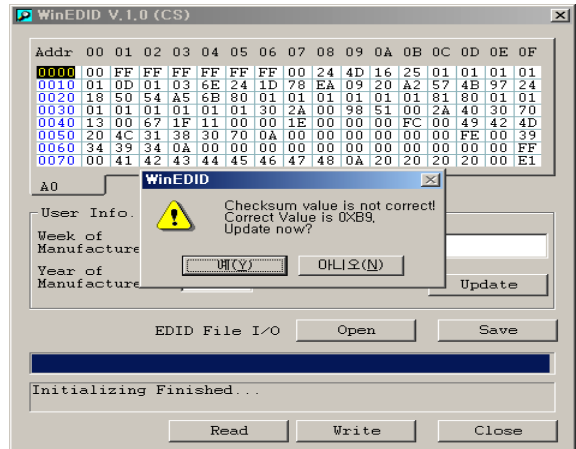



## SERVICE OSD

- 1) Turn off the power switch at the front side of the display.
- 2) Wait for about 5 seconds and press MENU, POWER switch with 1 second interval.
- 3) The SVC OSD menu contains additional menus that the User OSD menu as described below.
  - a) Auto Color : W/B balance and Automatically sets the gain and offset value.
  - b) NVRAM INIT : EEPROM initialize.(24C08)
  - c) CLEAR ETI : To initialize using time.
  - d) AGING : Select Aging mode(on/off).
  - e) R/G/B-9300K : Allows you to set the R/G/B-9300K value manually.
  - f) R/G/B-6500K : Allows you to set the R/G/B-6500K value manually.
  - g) R/G/B-Offset : Allows you to set the R/G/B-Offset value manually.(Analog Only)
  - h) R/G/B-Gain : Allows you to set the R/G/B-Gain value manually.(Analog Only)
  - i) MODULE : To select applied module.

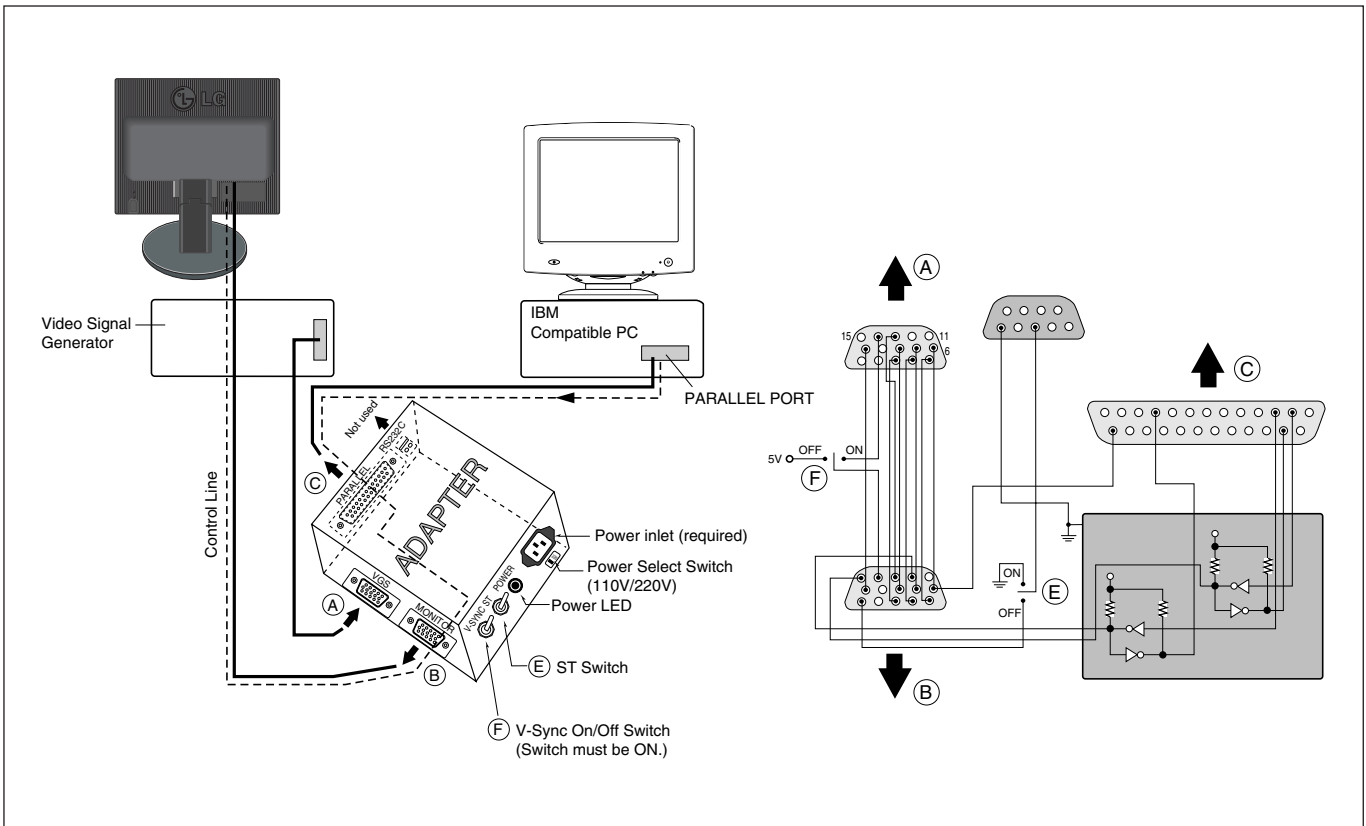
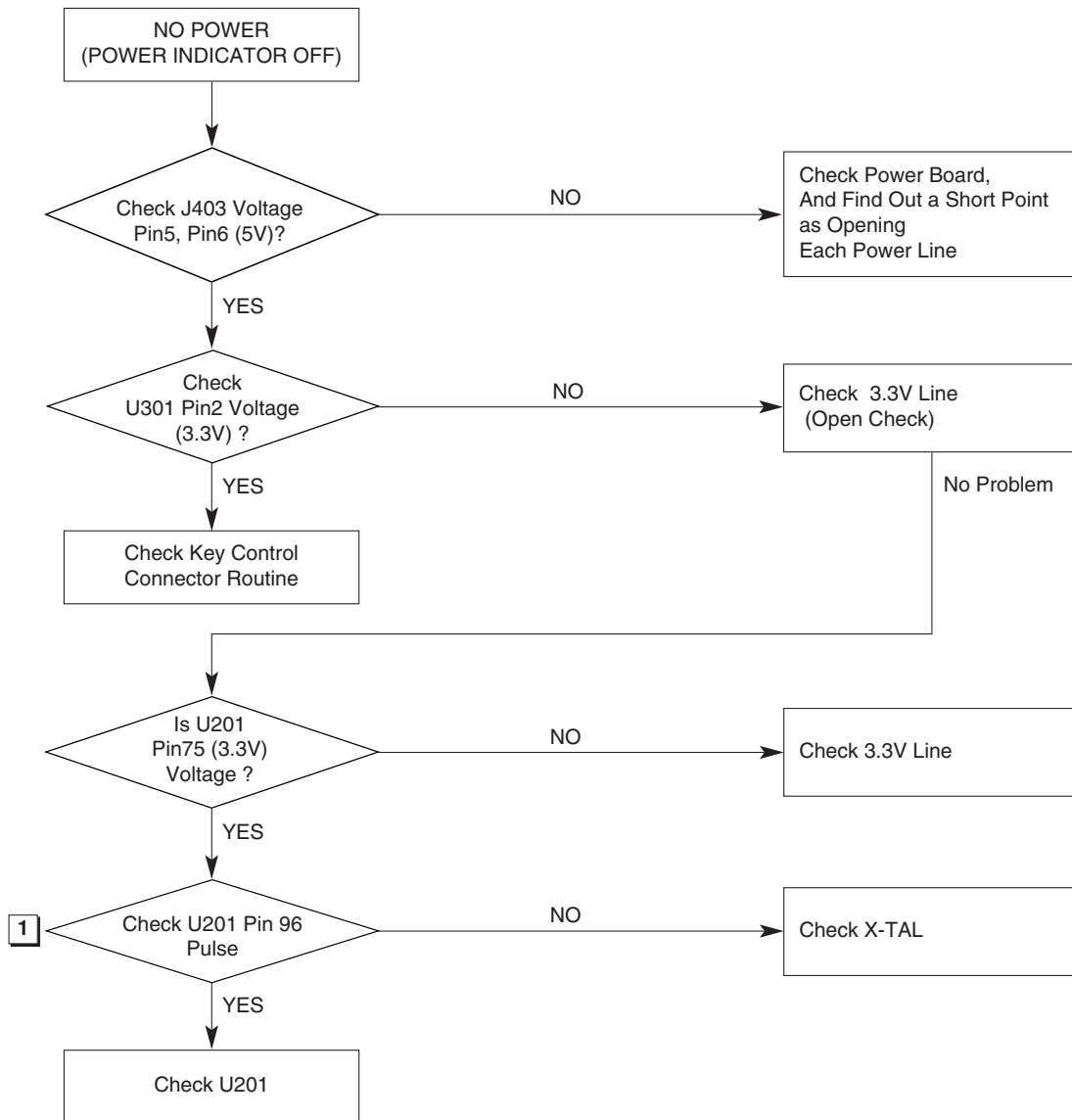

Figure 1. Cable Connection

# TROUBLESHOOTING GUIDE

## 1. NO POWER



### Waveforms

1 U201-#96

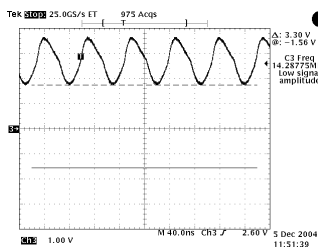

## 2. NO RASTER (OSD IS NOT DISPLAYED) – LIPS

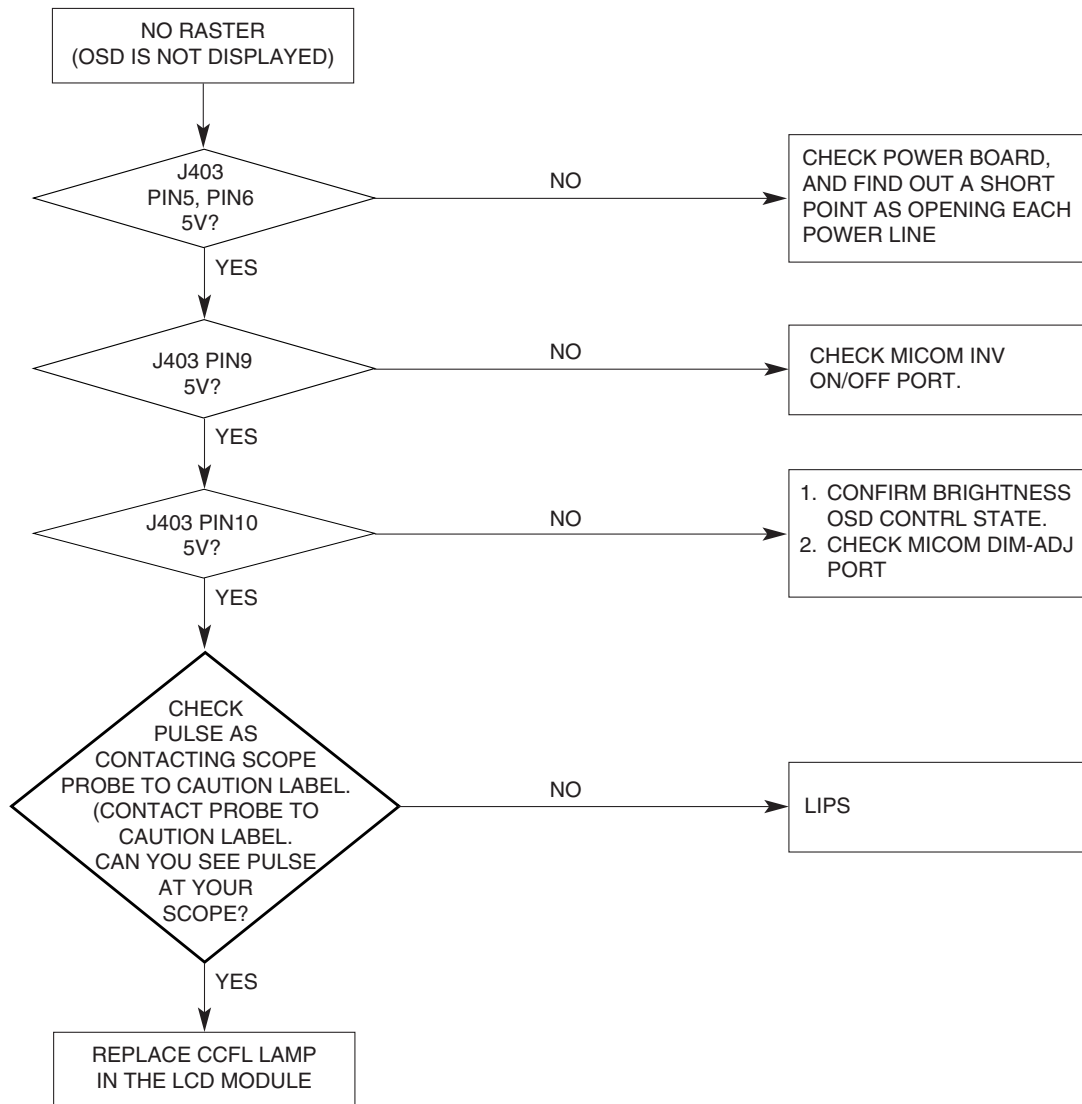

### 3. NO RASTER (OSD IS NOT DISPLAYED) – MSTAR

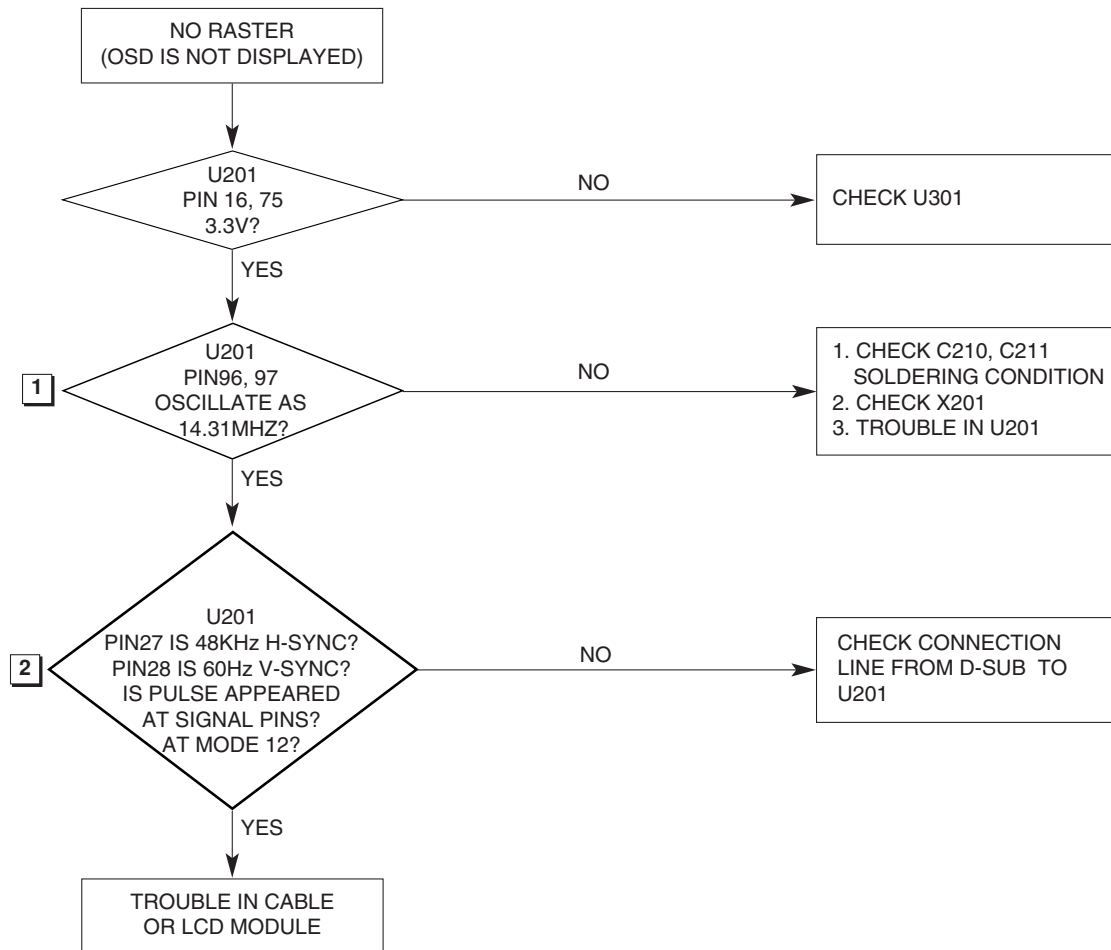

#### Waveforms

1 U201-#96, 97

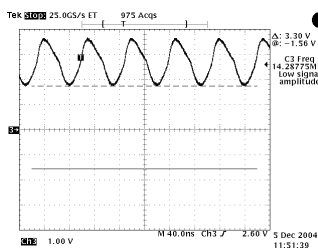

2 U201-#27 H-SYNC

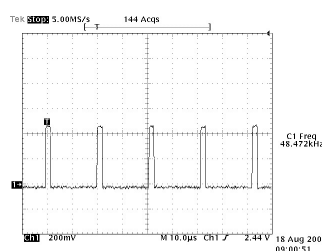

2 U201-#28 V-SYNC

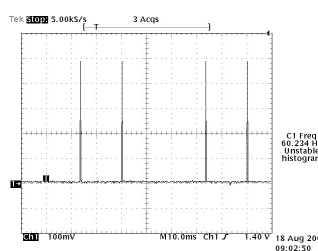

## 4. TROUBLE IN DPM

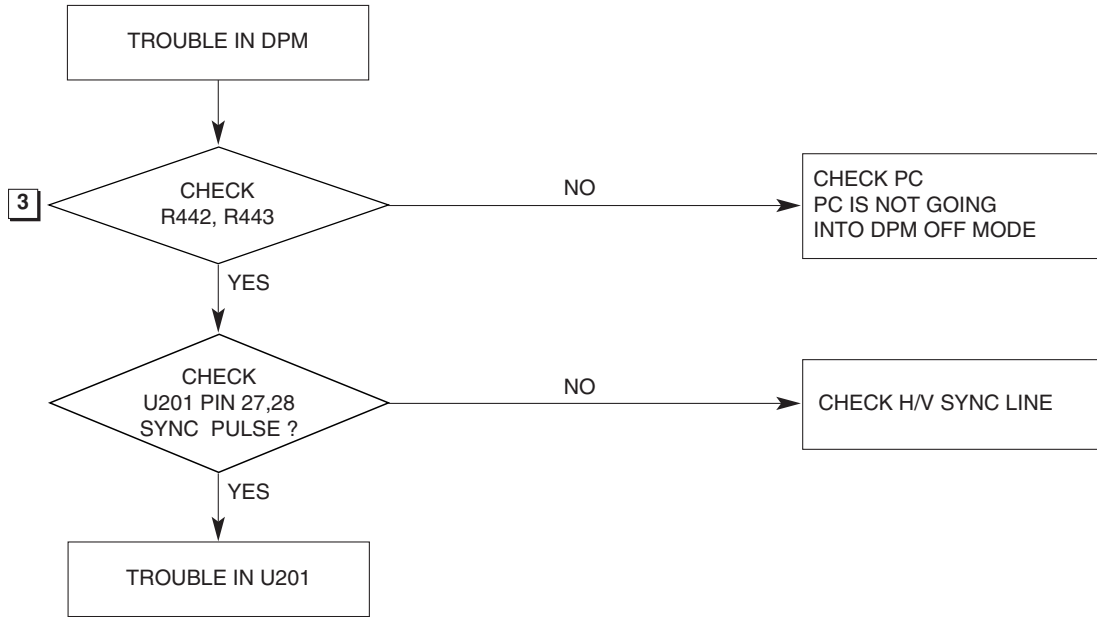

### Waveforms

**3** R442 H-Sync

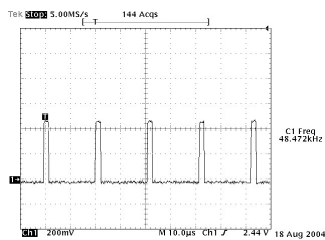

**3** R443 V-Sync

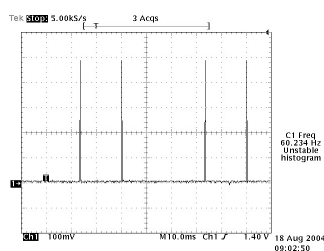

## 5. POWER

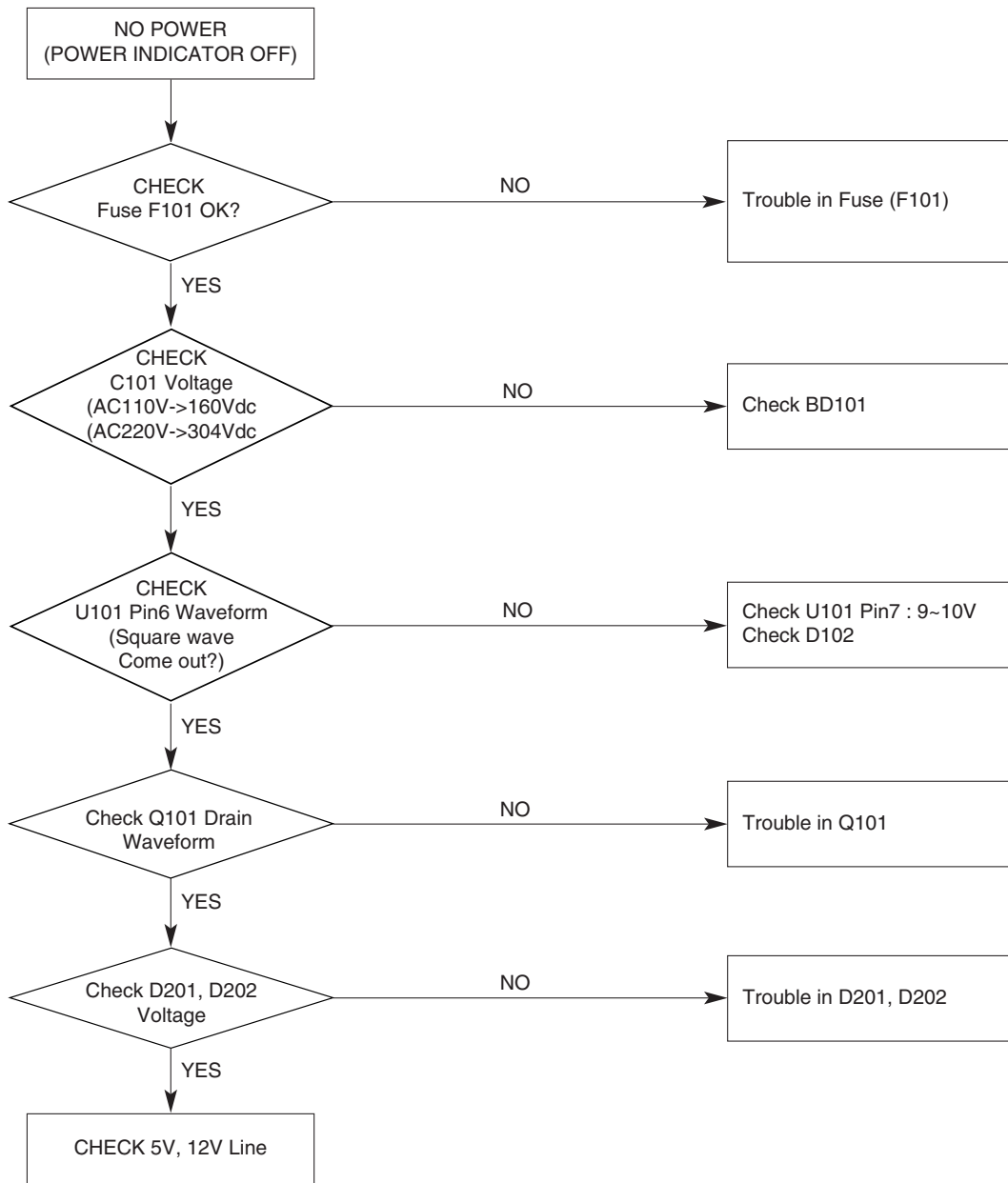

## 6. Raster

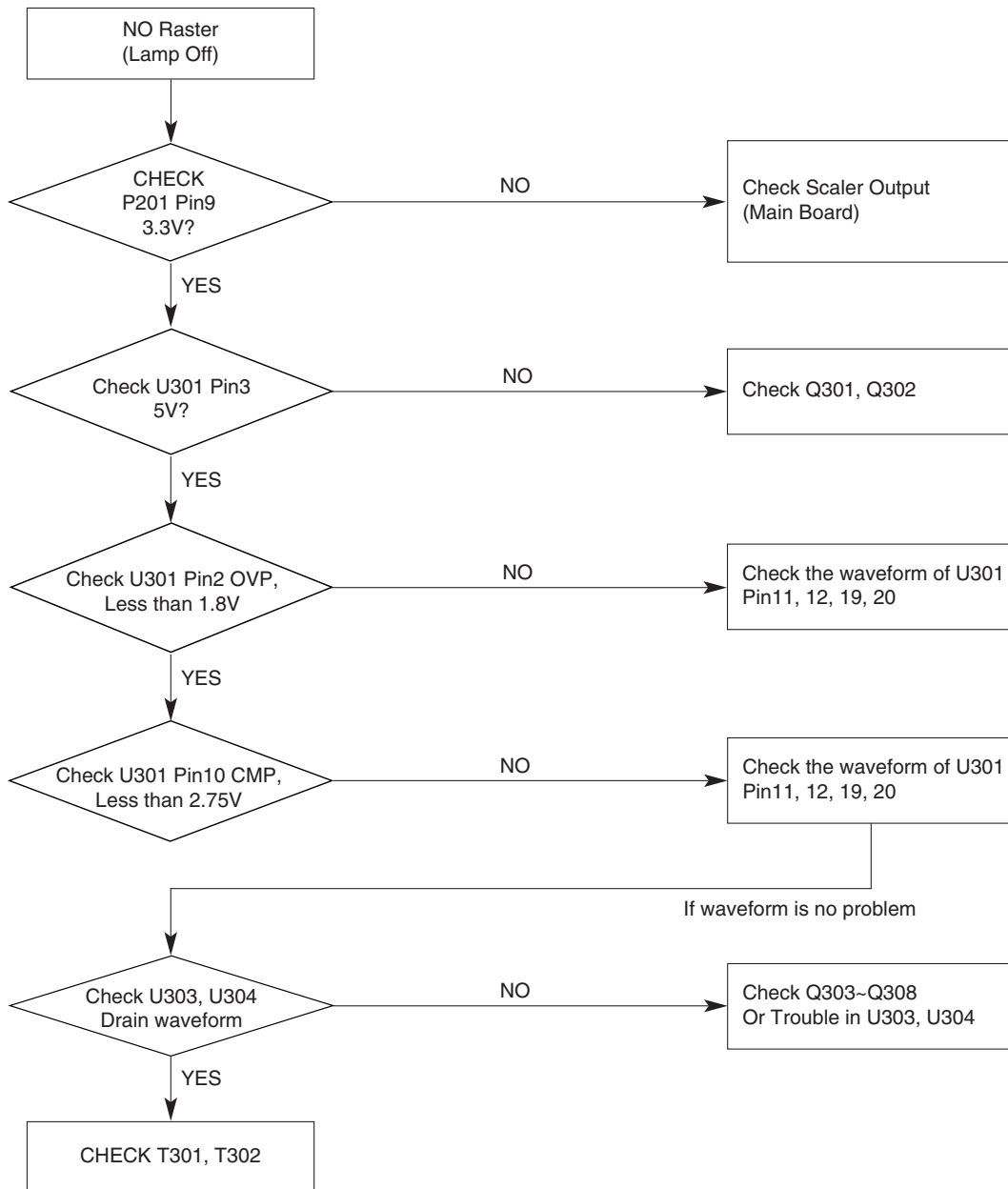

# WIRING DIAGRAM

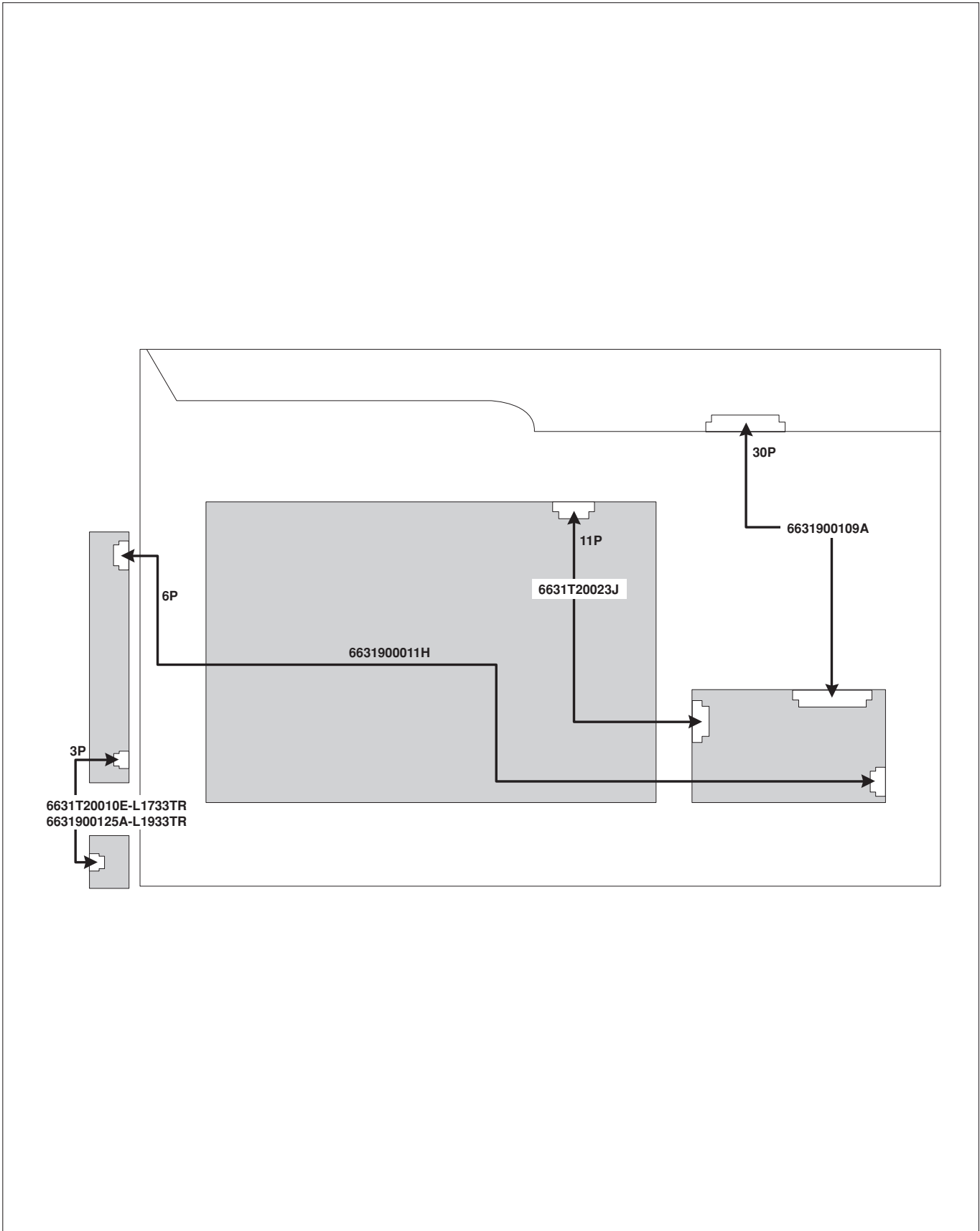



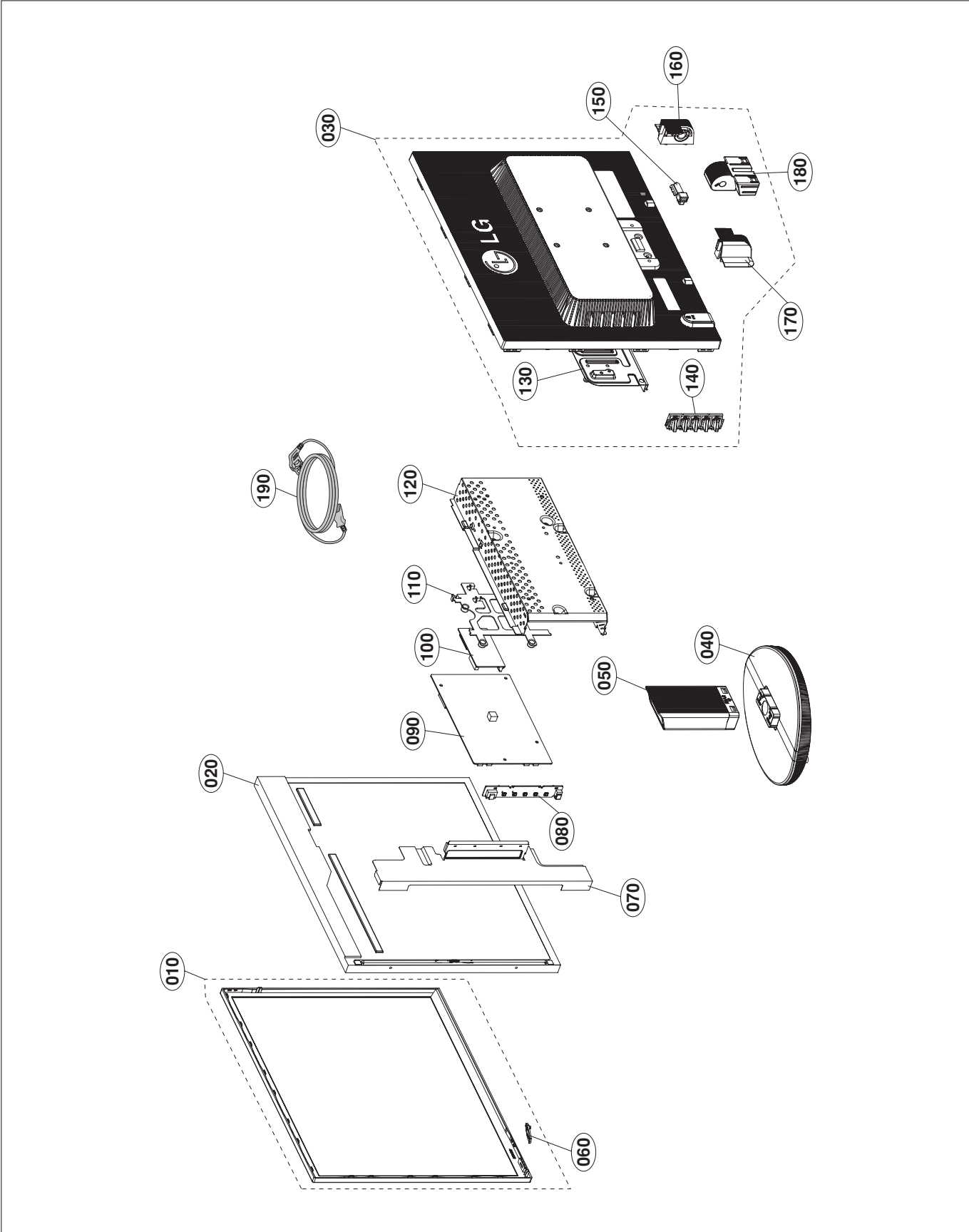

# EXPLODED VIEW



## EXPLODED VIEW PARTS LIST

\* Note: Safety mark 

Ref. No.	Part No.	Description
010	 ABJ32220472	Cabinet Assembly, L1753 . 17" SILVER best buy for <b>L1733TR</b>
	ABJ32229471	Cabinet Assembly, L1953 . 19" SILVER <b>L1933TR</b> FOR BEST BUY
020	 EAJ32188801	LCD,Module-TFT, <b>LM170E03-TLB3 DRIVER 17.0INCH 1280X1024 300CD COLOR</b> 72% 5/4 800 VS 1 5MS, 160/160, 4LAMP, 2CH-LVDS LG PHILIPS LCD .
	EAJ32189001	LCD,Module-TFT, <b>LM190E08-TLB2 DRIVER 19.0INCH 1280X1024 300CD COLOR</b> 72% 5/4 800:1 P7 FACTORY 5MS, 160/160, 2CH-LVDS, 4LAMP LG PHILIPS LCD .
	or EAJ35908201	LCD,Module-TFT, <b>LM190E08-TLB6 DRIVER 17.0INCH 1280X1024 300CD COLOR</b> 72% 4/3 800:1 P7, Lusem/Lusem D-IC, 5ms LG PHILIPS LCD
	or EAJ32188901	LCD,Module-TFT, <b>LM190E08-TLB5 DRIVER 19INCH 1280X1024 300CD COLOR</b> 72% 5/4 800 : 1 P4 FACTORY 5MS, 2CH-LVDS, 160/160, 4LAMP LG PHILIPS LCD .
	6304FHS014B	LCD,Module-TFT, <b>HSD190ME13-D10(700VS1) DRIVER 19INCH 1280X1024 300CD COLOR</b> 72% 4/3 700:1 - HANNSTAR DISPLAY CORPORATION
030	 3809900177B	Cover Assembly, L1752T NON BACK COVER ASSY MODULE-LPL+DUAL- <b>L1733TR</b>
	3809900178B	Cover Assembly, L1952T NON BACK COVER ASSY MODULE-LPL+DUAL- <b>L1933TR</b>
	3809900178H	Cover Assembly, L1952T NON BACK COVER ASSY MODULE- <b>HSD-DUAL-L1933TR</b>
040	 AAN32608906	Base Assembly, ASSY Lx53 LM57B Lx53 PATTERN TEXTURE(3043900041L)
050	 35509K0245D	Cover, MOLD ABS L1752 ABS L1752 NEW BODY- <b>L1733TR</b>
	35509K0246D	Cover, MOLD ABS L1952 ABS L1952 NEW BODY- <b>L1933TR</b>
060	3520900038A	Indicator, LED&PRE AMP LX52 PMMA NON LED LENS
070	49509K0266A	Plate, SHIELD LX52 LAMP- <b>L1733TR</b>
	49509K0267F	Plate, PRESS SPTE-C 0.3 LAMP SPTE SHIELD for 19' LPL 5ms module- <b>L1933TR</b>
080	EBR36881501	PCB Assembly,Sub, CONTROL T.T LM57A ND L1953TR/HR... KXXXXPN L1953TR/HR...
090	 6709900027A	SMPS,AC/DC, AIVP 100VTO240V 40W 50TO60HZ UL/CSA/VDE/SEV/SEMKO/FIMKO/IMQ/OVE/BSI WORLD WIDE LIEN CHANG
	or 68719PT298A	PCB Assembly,Power, POWER T.T LM57A L1752S KNRDQPT -
100	EBU30504102	Main Total Assembly, L1752HQ-BFQ BRAND LM57B- <b>L1733TR</b>
	EBU30504105	Main Total Assembly, L1752HQ-BFQ BRAND LM57B- <b>L1933TR</b>
110	35509K0247A	Cover, MOLD ABS AF-320T L1752TX ABS .
120	49509S0034B	Plate, SHIELD LX52 REAR SHIELD-DUAL
130	49509K0262A	Plate, SUPPORT L1752 BRACKET- <b>L1733TR</b>
	49509K0263A	Plate, SUPPORT L1952S BRACKET- <b>L1933TR</b>
140	4940900022B	Knob, MAIN 5KEY LX52 TACK KNOB ADD SOURCE PRINTING
150	49519K0137A	Plate Assembly, ASSY STAND HINGE ASSY FOR LX52S/T
160	35509K0243A	Cover, LX52 HINGE L
170	35509K0242A	Cover, LX52 HINGE R
180	35509K0244A	Cover, LX52 HINGE COVER BODY
190	64109UP002A	Power Cord, DTII-3P-11+DTII-3P-04 HONGCHANG UL/CSA 1870MM PLUG BLACK
	or 6410TUW008A	Power Cord, UL_CSA,LP-31 & SVT 18X3C, LS-13_1.87M_BLK LP-31 LS-13 1.87M - 125V 10A SVT 3XAWG18 BLACK UL CSA N

# REPLACEMENT PARTS LIST

**CAUTION:** BEFORE REPLACING ANY OF THESE COMPONENTS,  
READ CAREFULLY THE **SAFETY PRECAUTIONS** IN THIS MANUAL.  
**MAIN BOARD AND POWER BOARD PARTS ARE DIFFERENT.**

\* NOTE : **S** SAFETY Mark   
**AL** ALTERNATIVE PARTS

DATE: 2007. 02. 06.				
*S	*AL	LOC. NO.	PART NO.	DESCRIPTION / SPECIFICATION
<b>MAIN BOARD</b>				
<b>CAPACITORS</b>				
		C501	0CK104CF56A	0603B104K160CT 100nF 10% 16V
		C502	0CK473CH56A	C1608X7R1E473KT 47nF 10% 25V
		C503	0CK473CH56A	C1608X7R1E473KT 47nF 10% 25V
		C504	0CK473CH56A	C1608X7R1E473KT 47nF 10% 25V
		C505	0CK473CH56A	C1608X7R1E473KT 47nF 10% 25V
		C506	0CC102CK41A	C1608C0G1H102JT 1nF 5% 50V C
		C507	0CK473CH56A	C1608X7R1E473KT 47nF 10% 25V
		C508	0CK473CH56A	C1608X7R1E473KT 47nF 10% 25V
		C509	0CC270CK41A	C1608C0G1H270JT 27pF 5% 50V
		C510	0CC270CK41A	C1608C0G1H270JT 27pF 5% 50V
		C511	0CK103CK51A	0603B103K500CT 10nF 10% 50V
		C512	0CK103CK51A	0603B103K500CT 10nF 10% 50V
		C513	0CK104CF56A	0603B104K160CT 100nF 10% 16V
		C514	0CK224CF56A	0603B224K160CT 220nF 10% 16V
		C515	0CE106CF638	SHL5.0TP16VB10M 10uF 20% 16V
		C516	0CK104CF56A	0603B104K160CT 100nF 10% 16V
		C517	0CK104CF56A	0603B104K160CT 100nF 10% 16V
		C518	0CK104CF56A	0603B104K160CT 100nF 10% 16V
		C519	0CK104CF56A	0603B104K160CT 100nF 10% 16V
		C520	0CK104CF56A	0603B104K160CT 100nF 10% 16V
		C521	0CK104CF56A	0603B104K160CT 100nF 10% 16V
		C522	0CK104CF56A	0603B104K160CT 100nF 10% 16V
		C523	0CK104CF56A	0603B104K160CT 100nF 10% 16V
		C524	0CK104CF56A	0603B104K160CT 100nF 10% 16V
		C525	0CK104CF56A	0603B104K160CT 100nF 10% 16V
		C526	0CK104CF56A	0603B104K160CT 100nF 10% 16V
		C527	0CK104CF56A	0603B104K160CT 100nF 10% 16V
		C528	0CK104CF56A	0603B104K160CT 100nF 10% 16V
		C529	0CK104CF56A	0603B104K160CT 100nF 10% 16V
		C530	0CK104CF56A	0603B104K160CT 100nF 10% 16V
		C531	0CK104CF56A	0603B104K160CT 100nF 10% 16V
		C532	0CK104CF56A	0603B104K160CT 100nF 10% 16V
		C533	0CK104CF56A	0603B104K160CT 100nF 10% 16V
		C534	0CK104CF56A	0603B104K160CT 100nF 10% 16V
		C535	0CK104CF56A	0603B104K160CT 100nF 10% 16V
		C536	0CK104CF56A	0603B104K160CT 100nF 10% 16V
		C537	0CK104CF56A	0603B104K160CT 100nF 10% 16V
		C538	0CK104CF56A	0603B104K160CT 100nF 10% 16V
		C701	0CC101CK41A	C1608C0G1H101JT 100pF 5% 50V
		C702	0CC101CK41A	C1608C0G1H101JT 100pF 5% 50V
		C703	0CC680CK41A	C1608C0G1H680JT 68pF 5% 50V
		C704	0CK104CK56A	0603B104K500CT 100nF 10% 50V
		C705	0CC680CK41A	C1608C0G1H680JT 68pF 5% 50V
		C706	0CK104CF56A	0603B104K160CT 100nF 10% 16V
		C707	0CK104CF56A	0603B104K160CT 100nF 10% 16V
		C708	0CK104CF56A	0603B104K160CT 100nF 10% 16V
		C709	0CK104CF56A	0603B104K160CT 100nF 10% 16V
		C710	0CK104CF56A	0603B104K160CT 100nF 10% 16V
		C711	0CK104CF56A	0603B104K160CT 100nF 10% 16V
		C712	0CK104CF56A	0603B104K160CT 100nF 10% 16V
		C713	0CK104CF56A	0603B104K160CT 100nF 10% 16V
		C714	0CC680CK41A	C1608C0G1H680JT 68pF 5% 50V

DATE: 2007. 02. 06.				
*S	*AL	LOC. NO.	PART NO.	DESCRIPTION / SPECIFICATION
		C715	0CC680CK41A	C1608C0G1H680JT 68pF 5% 50V
		C716	0CK104CF56A	0603B104K160CT 100nF 10% 16V
		C717	0CK104CF56A	0603B104K160CT 100nF 10% 16V
		C718	0CK104CF56A	0603B104K160CT 100nF 10% 16V
		C719	0CK104CF56A	0603B104K160CT 100nF 10% 16V
		C720	0CK104CF56A	0603B104K160CT 100nF 10% 16V
		C723	0CK104CF56A	0603B104K160CT 100nF 10% 16V
		C724	0CK105CD56A	C1608X7R1A105KT 1uF 10% 10V
		C725	0CC101CK41A	C1608C0G1H101JT 100pF 5% 50V
		C901	0CE107EF610	KMG16VB100M 100uF 20% 16V 12
		C902	0CK103CK51A	0603B103K500CT 10nF 10% 50V
		C903	0CC102CK41A	C1608C0G1H102JT 1nF 5% 50V C
		C904	0CK105CD56A	C1608X7R1A105KT 1uF 10% 10V
		C905	0CE107EF610	KMG16VB100M 100uF 20% 16V 12
		C906	0CE107EF610	KMG16VB100M 100uF 20% 16V 12
		C907	0CE107EF610	KMG16VB100M 100uF 20% 16V 12
		C908	0CK104CK56A	0603B104K500CT 100nF 10% 50V
		C909	0CK104CK56A	0603B104K500CT 100nF 10% 50V
		C910	0CK104CK56A	0603B104K500CT 100nF 10% 50V
		C911	0CK102CK56A	0603B102K500CT 1nF 10% 50V X
		C912	0CK102CK56A	0603B102K500CT 1nF 10% 50V X
		C913	0CK102CK56A	0603B102K500CT 1nF 10% 50V X
		C914	0CE227EF610	KMG16VB220M 220uF 20% 16V 21
<b>DIODES</b>				
		D701	0DS226009AA	KDS226 1.2V 85V 300MA 2A 4NS
		D702	0DS226009AA	KDS226 1.2V 85V 300MA 2A 4NS
		D703	0DS226009AA	KDS226 1.2V 85V 300MA 2A 4NS
		D704	0DS226009AA	KDS226 1.2V 85V 300MA 2A 4NS
		D705	0DS226009AA	KDS226 1.2V 85V 300MA 2A 4NS
		D706	0DS226009AA	KDS226 1.2V 85V 300MA 2A 4NS
		D707	0DS226009AA	KDS226 1.2V 85V 300MA 2A 4NS
		D708	0DS226009AA	KDS226 1.2V 85V 300MA 2A 4NS
		D709	0DS226009AA	KDS226 1.2V 85V 300MA 2A 4NS
		D710	0DS226009AA	KDS226 1.2V 85V 300MA 2A 4NS
		D711	0DS226009AA	KDS226 1.2V 85V 300MA 2A 4NS
		D712	0DSON00138A	MMBD301LT1G 600MV 30V -- 1.
		D713	0DD184009AA	KDS184 KDS184 TP KEC - 85V -
		D714	0DSON00138A	MMBD301LT1G 600MV 30V -- 1.
		D715	0DD184009AA	KDS184 KDS184 TP KEC - 85V -
		ZD701	0DZ560009GB	BZT52C5V6S-(F) 5.6V 5.2TO6V
		ZD702	0DZ560009GB	BZT52C5V6S-(F) 5.6V 5.2TO6V
		ZD703	0DZ560009GB	BZT52C5V6S-(F) 5.6V 5.2TO6V
		ZD704	0DZ560009GB	BZT52C5V6S-(F) 5.6V 5.2TO6V
		ZD705	0DZ560009GB	BZT52C5V6S-(F) 5.6V 5.2TO6V
		ZD708	0DZ560009GB	BZT52C5V6S-(F) 5.6V 5.2TO6V
		ZD709	0DZ560009GB	BZT52C5V6S-(F) 5.6V 5.2TO6V
		ZD710	0DZ560009GB	BZT52C5V6S-(F) 5.6V 5.2TO6V
<b>ICs</b>				
		U501	0IIPRP00784A	FE251MOH-LF(TSUMO56WHJ-LF) 3
		U502	EAN30510505	L1952HQ-SFQ ARDRQP TSUMO G

DATE: 2007. 02. 06.				
*S	*AL	LOC. NO.	PART NO.	DESCRIPTION / SPECIFICATION
		U503	0ISG240860B	M24C08-WMN6TP 8KBIT 1KX8BIT-L1733TR
		U503	0IMMR00203A	FM24C08 8KBIT 1KX8BIT 2.7VTO-L1933TR
		U701	0IMMR00014A	M24C02-RMN6TP 2KBIT 256X8BIT
		U702	0IMMR00014A	M24C02-RMN6TP 2KBIT 256X8BIT
		U901	0IPMGFA003G	FAN1117AS33X 4.8TO10.3V 3.3V
		U902	0IPMGSG016A	LD1086D2T18TR 3.4TO30V 1.8V-L1733TR
		U902	0IPMG78403A	AZ1086S-1.8TRE1 3.2TO10V 1.8-L1933TR
<b>FILTERs</b>				
		L901	0LCML00003B	MLB-201209-0120P-N2 120OHM 2
		L902	0LCML00003B	MLB-201209-0120P-N2 120OHM 2
		L903	0LCML00003B	MLB-201209-0120P-N2 120OHM 2
<b>TRANSISTOR</b>				
		Q501	0TR390409AE	KST3904 NPN 6V 60V 40V 200MA-L1733TR
		Q501	0TRKE80046A	2N3904S NPN 6V 60V 40V 200MA-L1933TR
		Q701	0TR390609FA	KST3906-MTF PNP -5V -40V -40-L1733TR
		Q701	0TR390609DC	2N3906S-RTK PNP -5V -40V -40-L1933TR
		Q702	0TR390609FA	KST3906-MTF PNP -5V -40V -40-L1733TR
		Q702	0TR390609DC	2N3906S-RTK PNP -5V -40V -40-L1933TR
<b>RESISTORS</b>				
		R501	0RJ1000D677	MCR03EZPJ101 100OHM 5% 1/10W
		R502	0RJ0562D677	MCR03EZPJ560 56OHM 5% 1/10W
		R503	0RJ1000D677	MCR03EZPJ101 100OHM 5% 1/10W
		R504	0RJ0562D677	MCR03EZPJ560 56OHM 5% 1/10W
		R505	0RJ4700D677	MCR03EZPJ471 470OHM 5% 1/10W
		R506	0RJ1000D677	MCR03EZPJ101 100OHM 5% 1/10W
		R507	0RJ0562D677	MCR03EZPJ560 56OHM 5% 1/10W
		R508	0RJ4701D677	MCR03EZPJ472 4.7KOHM 5% 1/10
		R509	0RJ4701D677	MCR03EZPJ472 4.7KOHM 5% 1/10
		R510	0RJ4701D677	MCR03EZPJ472 4.7KOHM 5% 1/10
		R511	0RJ4701D677	MCR03EZPJ472 4.7KOHM 5% 1/10
		R512	0RJ4700D677	MCR03EZPJ471 470OHM 5% 1/10W
		R513	0RJ4700D677	MCR03EZPJ471 470OHM 5% 1/10W
		R516	0RJ3900D677	MCR03EZPJ391 390OHM 5% 1/10W
		R517	0RJ1002D677	MCR03EZPJ103 10KOHM 5% 1/10W
		R518	0RJ0000D677	MCR03EZPJ000 0OHM 5% 1/10W 1
		R519	0RJ1502D677	MCR03EZPJ153 15KOHM 5% 1/10W
		R522	0RJ4701D677	MCR03EZPJ472 4.7KOHM 5% 1/10
		R523	0RJ1000D677	MCR03EZPJ101 100OHM 5% 1/10W
		R524	0RJ1002D677	MCR03EZPJ103 10KOHM 5% 1/10W
		R525	0RJ4701D677	MCR03EZPJ472 4.7KOHM 5% 1/10
		R526	0RJ0332D677	MCR03EZPJ330 33OHM 5% 1/10W
		R527	0RJ0332D677	MCR03EZPJ330 33OHM 5% 1/10W
		R530	0RJ1002D677	MCR03EZPJ103 10KOHM 5% 1/10W
		R701	0RJ4701D677	MCR03EZPJ472 4.7KOHM 5% 1/10
		R702	0RJ4701D677	MCR03EZPJ472 4.7KOHM 5% 1/10
		R703	0RJ0332D677	MCR03EZPJ330 33OHM 5% 1/10W
		R704	0RJ0102D677	MCR03EZPJ100 10OHM 5% 1/10W
		R705	0RJ0102D677	MCR03EZPJ100 10OHM 5% 1/10W
		R706	0RJ0102D677	MCR03EZPJ100 10OHM 5% 1/10W
		R707	0RJ0102D677	MCR03EZPJ100 10OHM 5% 1/10W
		R708	0RJ0102D677	MCR03EZPJ100 10OHM 5% 1/10W
		R709	0RJ0102D677	MCR03EZPJ100 10OHM 5% 1/10W
		R710	0RJ0332D677	MCR03EZPJ330 33OHM 5% 1/10W
		R711	0RJ0000D677	MCR03EZPJ000 0OHM 5% 1/10W 1
		R712	0RJ0102D677	MCR03EZPJ100 10OHM 5% 1/10W
		R713	0RJ0102D677	MCR03EZPJ100 10OHM 5% 1/10W

DATE: 2007. 02. 06.				
*S	*AL	LOC. NO.	PART NO.	DESCRIPTION / SPECIFICATION
		R714	0RJ1001D677	MCR03EZPJ102 1KOHM 5% 1/10W
		R715	0RJ0000D677	MCR03EZPJ000 0OHM 5% 1/10W 1
		R716	0RJ0332D677	MCR03EZPJ330 33OHM 5% 1/10W
		R717	0RJ0752D677	MCR03EZPJ750 75OHM 5% 1/10W
		R718	0RJ0682D677	MCR03EZPJ680 68OHM 5% 1/10W
		R719	0RJ0682D677	MCR03EZPJ680 68OHM 5% 1/10W
		R720	0RJ0332D677	MCR03EZPJ330 33OHM 5% 1/10W
		R721	0RJ0752D677	MCR03EZPJ750 75OHM 5% 1/10W
		R722	0RJ0752D677	MCR03EZPJ750 75OHM 5% 1/10W
		R723	0RJ0000D677	MCR03EZPJ000 0OHM 5% 1/10W 1
		R724	0RJ4701D677	MCR03EZPJ472 4.7KOHM 5% 1/10
		R725	0RJ4701D677	MCR03EZPJ472 4.7KOHM 5% 1/10
		R726	0RJ4701D677	MCR03EZPJ472 4.7KOHM 5% 1/10
		R727	0RJ4701D677	MCR03EZPJ472 4.7KOHM 5% 1/10
		R728	0RJ4701D677	MCR03EZPJ472 4.7KOHM 5% 1/10
		R729	0RJ4701D677	MCR03EZPJ472 4.7KOHM 5% 1/10
		R730	0RJ2200D677	MCR03EZPJ221 220OHM 5% 1/10W
		R731	0RJ2200D677	MCR03EZPJ221 220OHM 5% 1/10W
		R732	0RJ1000D677	MCR03EZPJ101 100OHM 5% 1/10W
		R733	0RJ1000D677	MCR03EZPJ101 100OHM 5% 1/10W
		R735	0RJ2001D677	MCR03EZPJ202 2KOHM 5% 1/10W
		R736	0RJ4701D677	MCR03EZPJ472 4.7KOHM 5% 1/10
		R737	0RJ4701D677	MCR03EZPJ472 4.7KOHM 5% 1/10
		R738	0RJ4701D677	MCR03EZPJ472 4.7KOHM 5% 1/10
		R739	0RJ4701D677	MCR03EZPJ472 4.7KOHM 5% 1/10
		R903	0RJ5600D677	MCR03EZPJ561 560OHM 5% 1/10W
		R904	0RJ2202D677	MCR03EZPJ223 22KOHM 5% 1/10W
		R905	0RJ2702D677	MCR03EZPJ273 27KOHM 5% 1/10W
		R907	0RX0331K668	RSD02F4J3R30 3.3OHM 5% 2W 12
		R909	0RJ0000D677	MCR03EZPJ000 0OHM 5% 1/10W 1
		R910	0RJ0000D677	MCR03EZPJ000 0OHM 5% 1/10W 1
<b>OTHERs</b>				
		J901	6630TGA005B	QH11121-DN0-D DVI 24P 1.90MM
		J902	6630G100316	DZ11AA1-HVG-PF D-SUB 15P 2.2
		J904	6602T20008E	SMW200-06P 6P 2.00MM 1R STRA
		J905	6602T20008K	SMW200-11P 11P 2.00MM 1R STR
		J906	6630V90219A	SMW200-28C 28P 2.0MM 2R STRA
		Q901	0TFV180067A	SI3865BDV(E)3 N-CHANNEL MOSF
		X501	6212AA2004F	HC-49/U 14.31818MHZ 30PPM(TX
<b>CONTROL BOARD</b>				
		R1	0RD7501Q609	RDM94T1J7K50 7.5KOHM 5% 1/4W
		R2	0RD7501Q609	RDM94T1J7K50 7.5KOHM 5% 1/4W
		R3	0RD1801Q609	RDM94T1J1K80 1.8KOHM 5% 1/4W
		R4	0RD1201Q609	RDM94T1J1K20 1.2KOHM 5% 1/4W
		R5	0RD1201Q609	RDM94T1J1K20 1.2KOHM 5% 1/4W
		SW1	140-058E	THVV502GBC 1C1P 12VDC 0.05A
		SW2	140-058E	THVV502GBC 1C1P 12VDC 0.05A
		SW3	140-058E	THVV502GBC 1C1P 12VDC 0.05A
		SW4	140-058E	THVV502GBC 1C1P 12VDC 0.05A
		SW5	140-058E	THVV502GBC 1C1P 12VDC 0.05A
		ZD1	0DZ560009AG	GDZJ5.6B 5.6V 5.45TO5.73V 60
		ZD2	0DZ560009AG	GDZJ5.6B 5.6V 5.45TO5.73V 60
		ZD3	0DZ560009AG	GDZJ5.6B 5.6V 5.45TO5.73V 60
		J1	6602T20009E	SMAW200-06P 6P 2.00MM 1R ANG
		J2	6602T20009B	SMAW200-03P 3P 2.00MM 1R ANG
		J3	6602T20009B	SMAW200-03P 3P 2.00MM 1R ANG
		LED1	EAV30486601	BL-BY0BK201G-AB-LC4.5 ROUND

DATE: 2007. 02. 06.				
*S	*AL	LOC. NO.	PART NO.	DESCRIPTION / SPECIFICATION
<b>POWER BOARD</b>				
<b>CAPACITORS</b>				
△		C101	0CZZ9ST017A	AL EL CAPACITOR 100UF 450V 2
		C103	0CZZ9ST014A	AL EL CAPACITOR 33UF 50V 20%
		C104	0CH5271K416	270PF 2012 50V 5% NP0 R/TP
		C105	0CZZ9ST013A	AL EL CAPACITOR 0.47UF 50V 2
		C106	0CK222DK4DA	2200PF 2012 50V 5% COG R/TP
		C107	0CK1040K945	"0.1UF D 50V 80%,-20% F(Y5V)"
		C201	0CKZTTA002E	EKR3A102K09FK5 SAMWHA 1KV 10
		C202	0CZZ9ST021A	AL EL CAPACITOR 1000UF 25V 2
		C203	0CZZ9ST020A	AL EL CAPACITOR 680UF 25V 20
		C204	0CZZ9ST018A	AL EL CAPACITOR 1000UF 16V 2
		C205	0CZZ9ST018A	AL EL CAPACITOR 1000UF 16V 2
		C206	0CZZ9ST021A	AL EL CAPACITOR 1000UF 25V 2
		C207	0CZZ9ST019A	AL EL CAPACITOR 470UF 25V 20
		C208	0CKZTTA002B	330PF 1KV K R TP5.0 TAPING .
		C210	0CH3104K566	0.1UF 50V 10% X7R 2012 R/TP
		C301	0CZZTCT006D	C3216X7R1E225M TDK 25V 2.2UF
		C303	0CZZTCT006D	C3216X7R1E225M TDK 25V 2.2UF
		C304	0CZZTCT006D	C3216X7R1E225M TDK 25V 2.2UF
		C305	0CZZTCT006D	C3216X7R1E225M TDK 25V 2.2UF
		C306	0CK224DH56A	0.22UF 2012 25V 10% R/TP X7R
		C307	0CH3104K566	0.1UF 50V 10% X7R 2012 R/TP
		C308	0CK105DH56A	1UF 2012 25V 10% X7R R/TP
		C309	0CK224DH56A	0.22UF 2012 25V 10% R/TP X7R
		C310	0CK105DH56A	1UF 2012 25V 10% X7R R/TP
		C313	0CH2393K516	39000PF 50V 10% B(Y5P) 2012
		C314	0CK152DK51A	1500PF 2012 50V 10% B(Y5P) R
		C315	0CH3103K516	10000PF 50V 10% B(Y5P) 2012
		C317	0CH5221K416	220PF 50V 5% NP0 2012 R/TP
		C320	0CZZTCT006D	C3216X7R1E225M TDK 25V 2.2UF
		C402	0CK22201510	2200PF D 1KV 10% B(Y5P) R
		C403	0CZZ9ST028A	CERAMIC DISK 10PF 6KV 5% TR
		C404	0CH2153K516	15000PF 50V 10% B(Y5P) 2012
		C405	0CK22201510	2200PF D 1KV 10% B(Y5P) R
		C406	0CZZ9ST028A	CERAMIC DISK 10PF 6KV 5% TR
		C407	0CH2153K516	15000PF 50V 10% B(Y5P) 2012
		C409	0CK22201510	2200PF D 1KV 10% B(Y5P) R
		C410	0CZZ9ST028A	CERAMIC DISK 10PF 6KV 5% TR
		C411	0CH2153K516	15000PF 50V 10% B(Y5P) 2012
		C412	0CK22201510	2200PF D 1KV 10% B(Y5P) R
		C413	0CZZ9ST028A	CERAMIC DISK 10PF 6KV 5% TR
		C414	0CH2153K516	15000PF 50V 10% B(Y5P) 2012
		C415	0CH2222K516	2200PF 50V 10% B(Y5P) 2012 R
		C417	0CH2222K516	2200PF 50V 10% B(Y5P) 2012 R
		C418	0CH2222K516	2200PF 50V 10% B(Y5P) 2012 R
		C419	0CH2222K516	2200PF 50V 10% B(Y5P) 2012 R
		CX101	0CZZ9ST025A	FILM CAPACITOR 0.47UF 275V 1
△		CY101	0CZZ9ST024A	"Y CAPACITOR 100PF 250V 10%,-"
△		CY102	0CZZ9ST024A	"Y CAPACITOR 100PF 250V 10%,-"
△		CY104	0CZZ9ST023A	"Y CAPACITOR 4700PF 250V 20%,-"
<b>DIODES</b>				
△		BD101	0DRTW00121A	D2SB60-1121 TIWAN SEMI ST GB
		D101	0DRDI00234A	PR1007 DIODES TAPING52 DO41
		D102	0DRDI00244A	1N4007/L DIODES TAPING52 DO4
		D103	0DSGF00019A	1N4148 GULF TP DO35 100V 0.1
		D201	0DRNH00140A	FCH10U15 NIHON INTER BULK TO
		D202	0DRNH00130A	FCH10U10 NIHON INTER BULK TO
		D306	0DSGD00048A	MM4148 GRANDE REEL TAPING LL
		D401	0DSDI00038A	"BAV99-(F),LF DIODES R/TP SOT"

DATE: 2007. 02. 06.				
*S	*AL	LOC. NO.	PART NO.	DESCRIPTION / SPECIFICATION
		D402	0DSDI00038A	"BAV99-(F),LF DIODES R/TP SOT"
		D403	0DSDI00038A	"BAV99-(F),LF DIODES R/TP SOT"
		D404	0DSDI00038A	"BAV99-(F),LF DIODES R/TP SOT"
		D405	0DSDI00038A	"BAV99-(F),LF DIODES R/TP SOT"
		D406	0DSDI00038A	"BAV99-(F),LF DIODES R/TP SOT"
		D407	0DSDI00038A	"BAV99-(F),LF DIODES R/TP SOT"
		D408	0DSDI00038A	"BAV99-(F),LF DIODES R/TP SOT"
		ZD101	0DZ330009CC	MTZJ3.3B TP ROHM-K DO34 - 3.
		ZD301	0DZGD00128A	ZMM5231B GRANDE REEL TAPING
<b>TRANSISTORS &amp; ICs</b>				
△		Q101	0TF760000AD	SSS7N60B FAIRCHILD ST TO220F
		Q301	0TR144009AI	DTA144EK CHIP TP ROHM - -
		Q302	0TR144009AH	DTC144EK CHIP TP ROHM - -
		Q303	0TRKE80046A	2N3904S KEC R/TP SOT23 60V 2
		Q304	0TR390609DC	2N3906S-RTK KEC REEL TAPING
		Q305	0TFDI80001A	2N7002 DIODES R/TP SOT23 60V
		Q306	0TFDI80001A	2N7002 DIODES R/TP SOT23 60V
		Q307	0TR390609DC	2N3906S-RTK KEC REEL TAPING
		Q308	0TRKE80046A	2N3904S KEC R/TP SOT23 60V 2
△		U101	0IPMG78425A	FAN7601 FAIRCHILD DIP-8P BUL
		U201	0IPMG78424A	"AZ431-A BCD 3P,TO-92 TAPING"
		U301	0IPMG78426A	OZL68GN O2MICRO 20P SOP BULK
		U303	0TFAN00001A	AP4511GD ADVANCED POWER ELEC
		U304	0TFAN00001A	AP4511GD ADVANCED POWER ELEC
△		PC201	0IPMG78432A	"LTV-817M-V(C) LITEON 4P, WID"
<b>RESISTORS</b>				
△		R101	0RJ4703G676	470K OHM 1/4 W 5% 3216 R/TP
		R102	0RJ6801E472	6800 OHM 1/8 W 1% 2012 R/TP
		R103	0RH1004D622	1M OHM 1 / 10 W 2012 5.00% D
		R104	0RH1001D622	1K OHM 1 / 10 W 2012 5.00% D
		R105	0RD0912Q609	91 OHM 1/4 W (3.4) 5% TA52
		R106	0RH2201D622	2.2K OHM 1 / 10 W 2012 5.00%
		R107	0RD8203A609	820K OHM 1/2 W(7.0) 5.00% TA
		R108	0RD4702A609	47K OHM 1/2 W(7.0) 5.00% TA5
		R109	0RX0560J609	0.56OHM 1 W 5% TA52
		R110	0RX1003K607	100KOHM 2 W 5% TA62
		R111	0RD0471Q609	4.70 1/4W(3 5% TA52
		R112	0RJ1302E472	13K OHM 1/8 W 1% 2012 R/TP
△		R115	0RJ4703G676	470K OHM 1/4 W 5% 3216 R/TP
△		R116	0RJ4703G676	470K OHM 1/4 W 5% 3216 R/TP
		R117	0RH2403D622	240K OHM 1 / 10 W 2012 5.00%
		R118	0RH2403D622	240K OHM 1 / 10 W 2012 5.00%
		R202	0RX0242K665	24 OHM 2 W 5% SF
		R204	0RN3002F409	30K OHM 1/6 W 1.00% TA52
		R205	0RN2201F409	2.2K OHM 1/6 W 1.00% TA52
		R206	0RJ1601E472	1.6K OHM 1/8 W 1% 2012 R/TP
		R207	0RH1001D622	1K OHM 1 / 10 W 2012 5.00% D
		R208	0RH6800D622	680 OHM 1 / 10 W 2012 5.00%
		R209	0RH1001D622	1K OHM 1 / 10 W 2012 5.00% D
		R211	0RJ1001G476	1K OHM 1/4 W 1% 3216 R/TP
		R301	0RD1001Q609	1K OHM 1/4 W(3.4) 5.00% TA52
		R303	0RH0222D622	22 OHM 1 / 10 W 2012 5.00% D
		R304	0RD1002Q609	10K OHM 1/4 W(3.4) 5.00% TA5
		R309	0RN1502F409	15K OHM 1/6 W 1.00% TA52
		R310	0RH1004D622	1M OHM 1 / 10 W 2012 5.00% D
		R311	0RH1502D422	"15K , 1/10W 1% TP"
		R313	0RJ6202E472	62K OHM 1/8 W 1% 2012 R/TP
		R315	0RH2001D622	2K OHM 1 / 10 W 2012 5.00% D



# SCHEMATIC DIAGRAM

## 1. SCALER

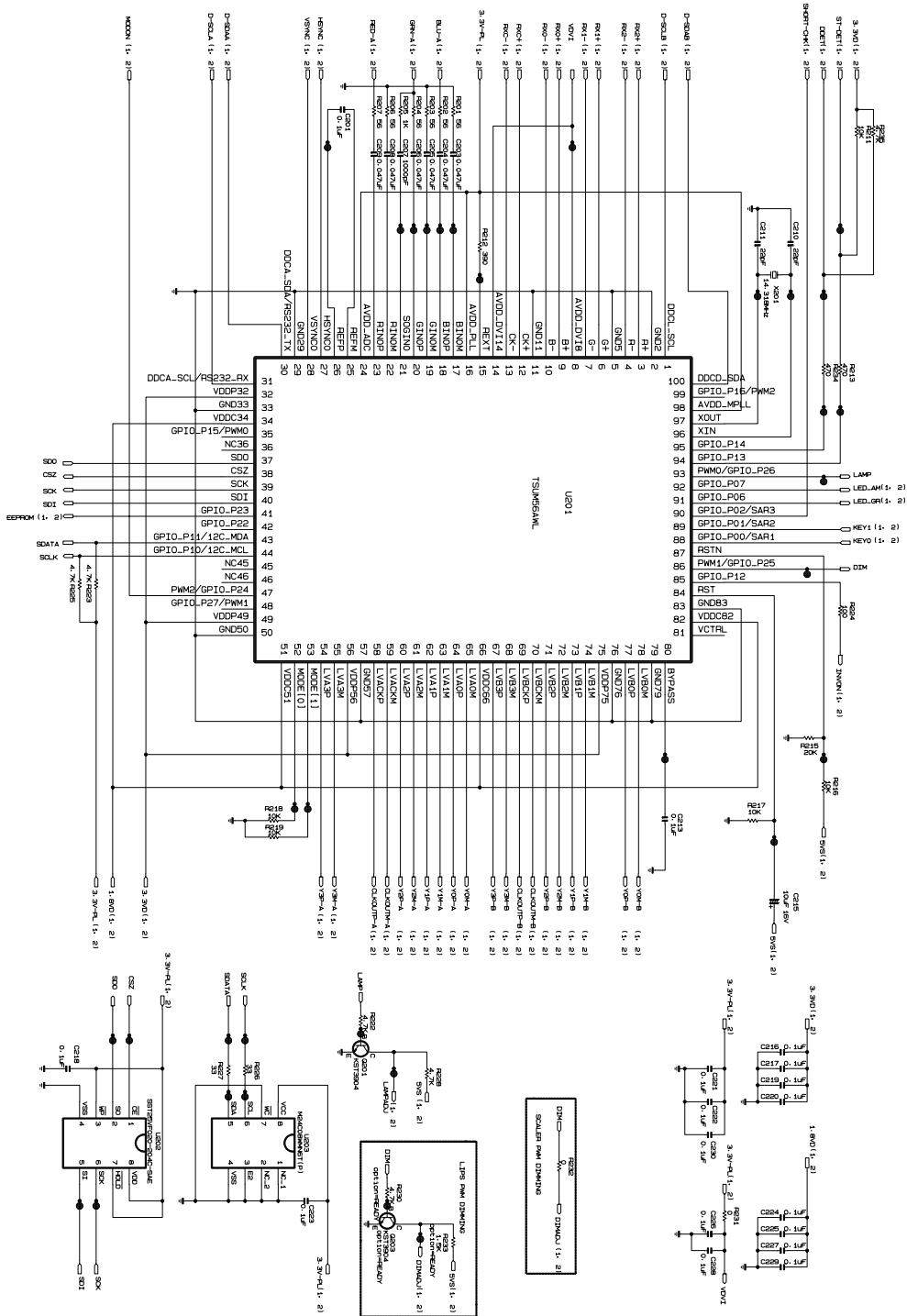

## 2. POWER & WAFER

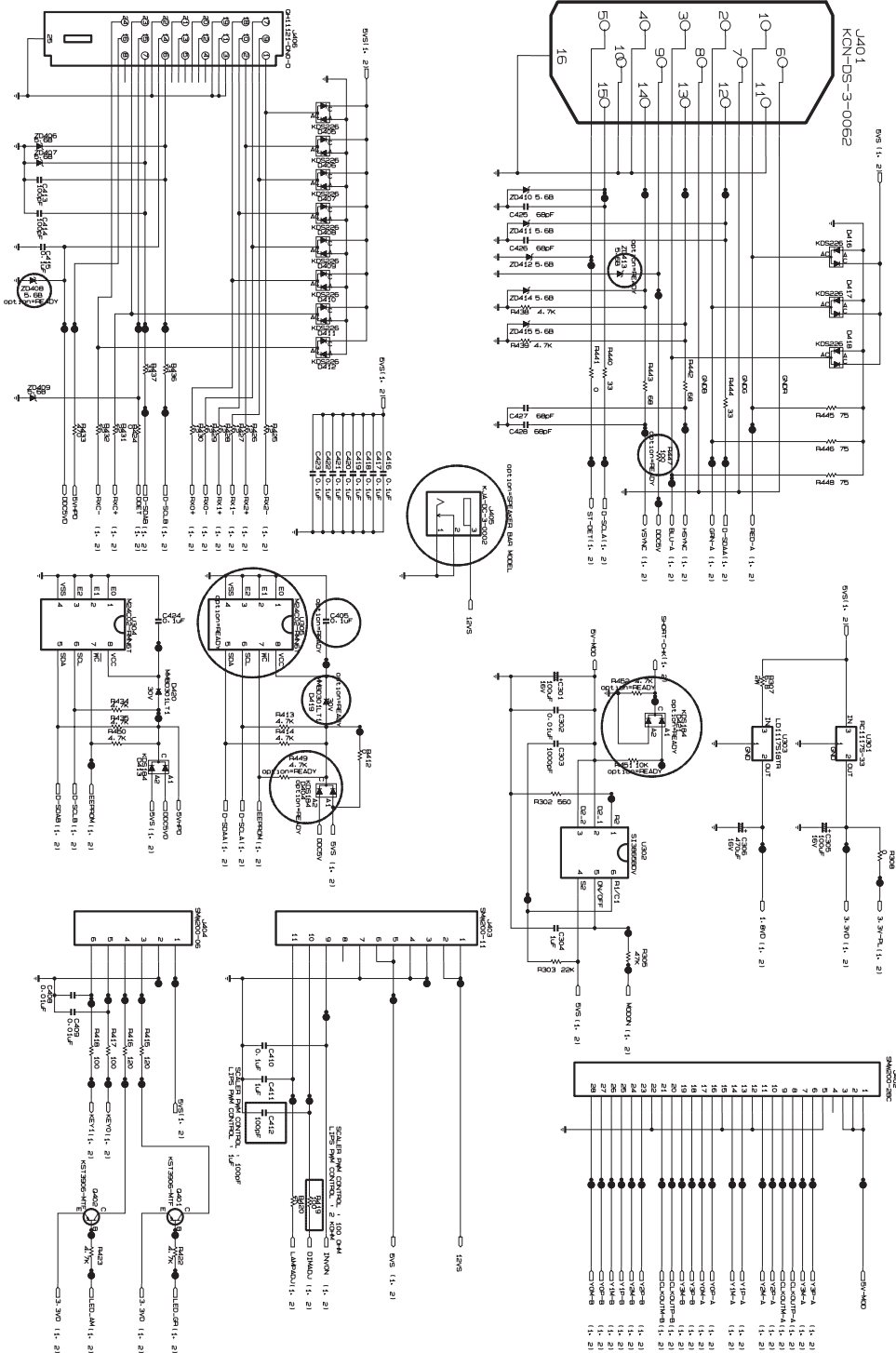



### 3. INVERTER

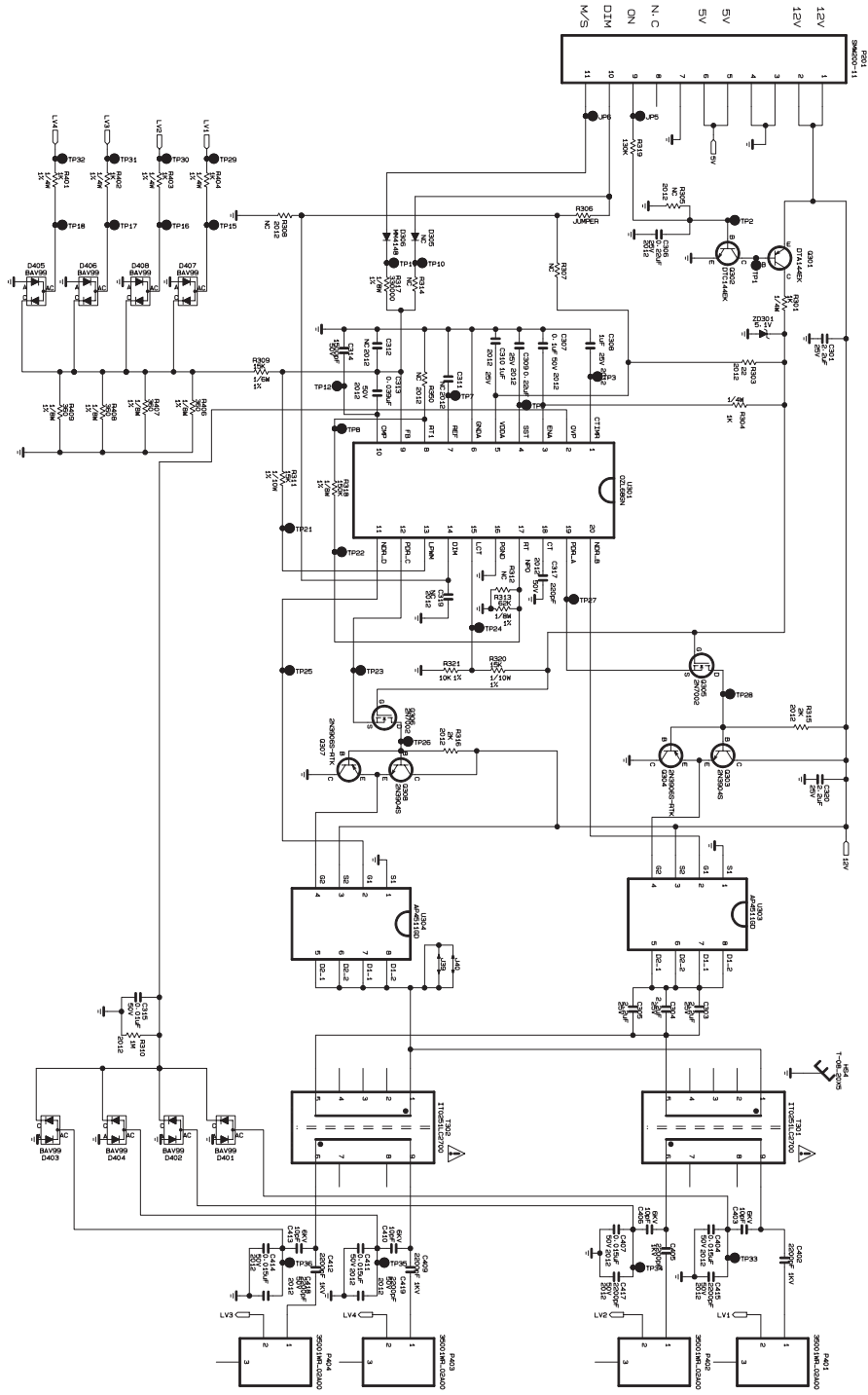

# 4. POWER

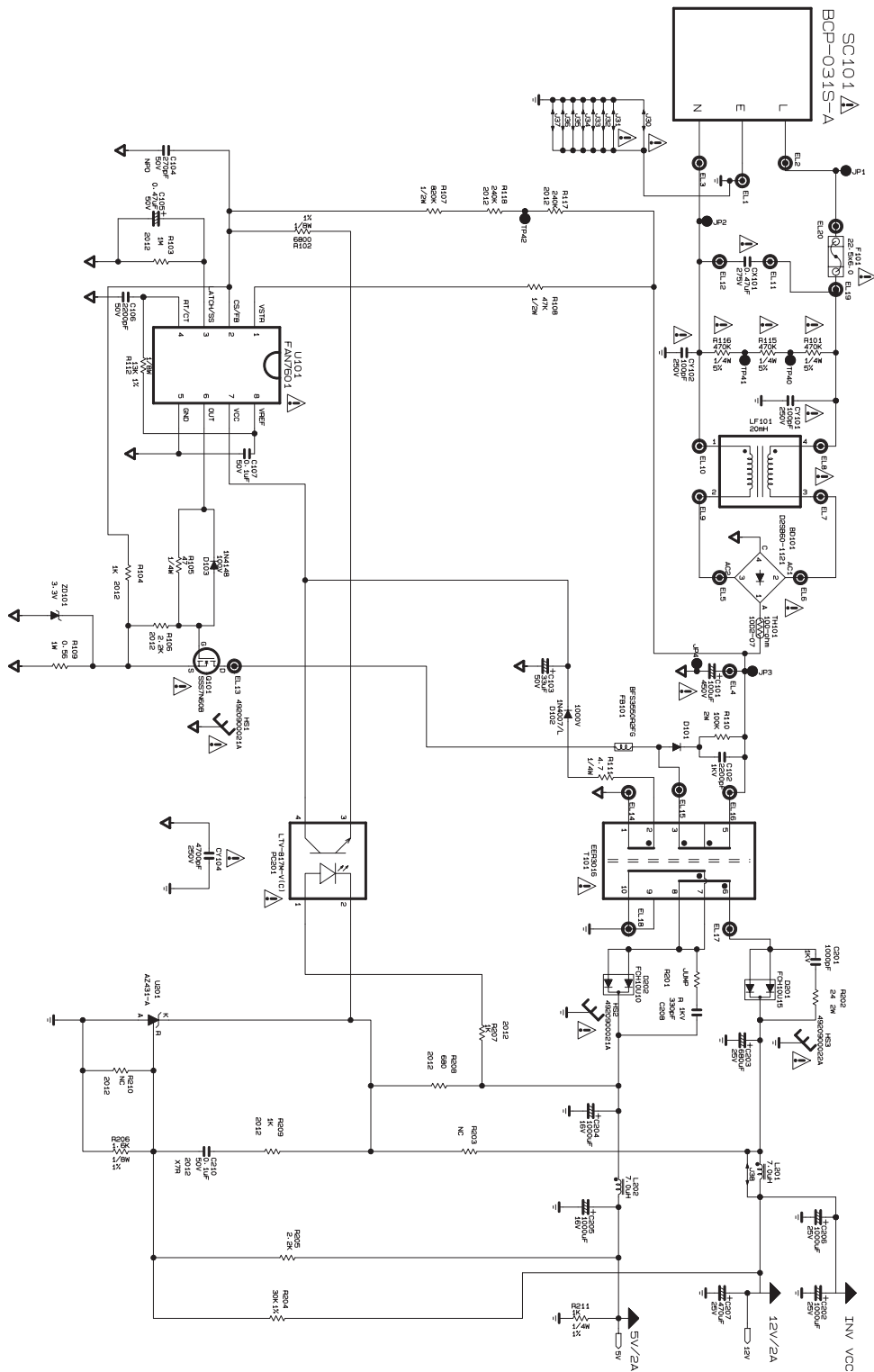



P/NO : MFL43002807

Feb. 2007  
Printed in Korea