

# FAN7382

## Half-Bridge Gate Driver (SOURCING/SINKING : 350mA/650mA)

### Features

- Floating Channel Designed For Bootstrap Operation To +600V.
- Typically 350mA/650mA Sourcing/Sinking Current Driving Capability For Both Channels
- Common-Mode dv/dt Noise Canceling Circuit
- Extended Allowable Negative VS Swing To -9V For Signal Propagation @ VCC=VBS=15V
- VCC & VBS Supply Range From 10V To 20V
- UVLO Functions For Both Channels
- TTL Compatible Input Logic Threshold Levels
- Matched Propagation Delay Below 50nsec
- Output In-phase With Input

### Description

The FAN7382 is a monolithic half-bridge gate driver IC for driving MOSFETs and IGBTs, which operate up to +600V. Fairchild's high voltage process and common-mode noise canceling technique give stable operation of high-side driver under high dv/dt noise circumstances. Advanced level shift circuit allows high-side gate driver operation up to  $V_S = -9.8$  V(typ.) for  $V_{BS} = 15$  V. The input logic level is compatible with standard TTL series logic gates. UVLO circuits for both channels prevent malfunction when VCC and VBS are lower than the specified threshold voltage. Output drivers typically source/sink 350mA/650mA, respectively, which is suitable for the applications such as fluorescent lamp ballast, PDP scan driver, motor control, etc.

### Typical Applications

- PDP Scan Driver
- Fluorescent Lamp Ballast

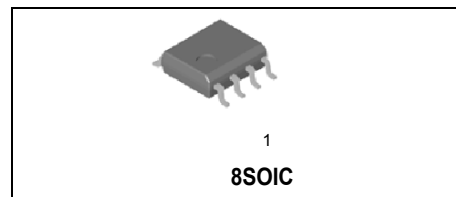

### Internal Block Diagram

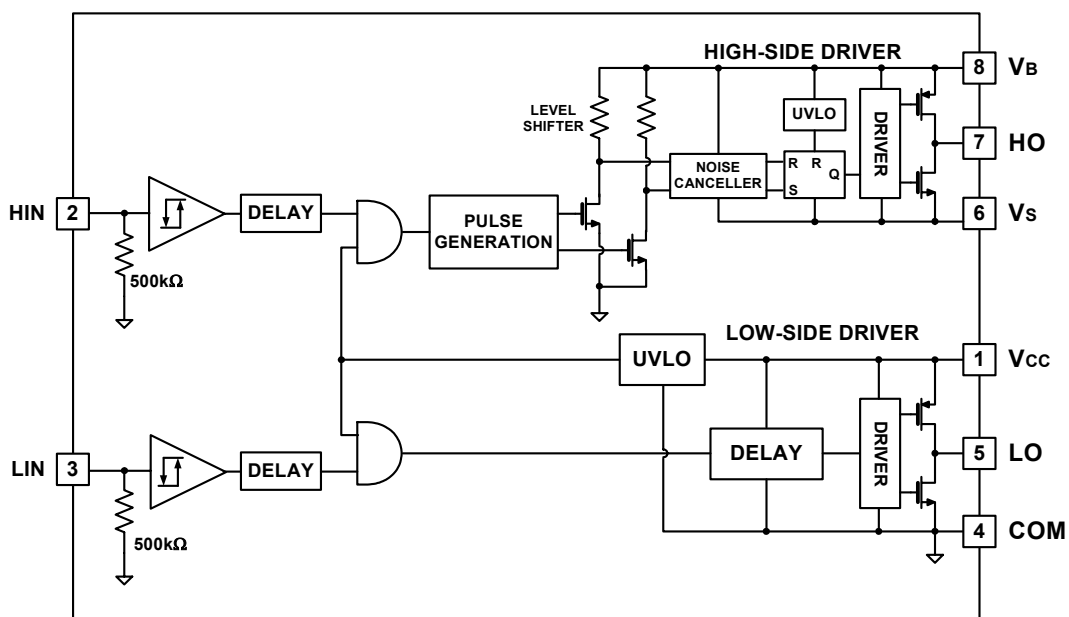

Rev. 0.0.3

## Pin Assignments

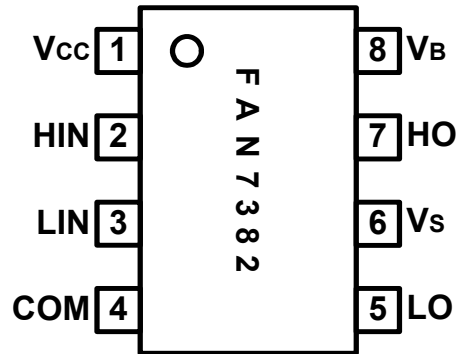

## Pin Descriptions

Pin No	Symbol	I/O	Description
1	VCC		Low Side Supply Voltage
2	HIN		Logic Input for High Side Gate Driver Output
3	LIN		Logic Input for Low Side Gate Driver Output
4	COM		Logic Ground and Low Side Driver Return
5	LO		Low Side Driver Output
6	VS		High Voltage Floating Supply Return
7	HO		High Side Driver Output
8	VB		High Side Floating Supply

## Absolute Maximum Ratings

Parameter	Symbol	Min.	Typ.	Max.	Unit
High side offset Voltage	V <sub>S</sub>	V <sub>BS</sub> -25	-	V <sub>BS</sub> +0.3	V
High side floating supply voltage	V <sub>B</sub>	-0.3		625	
High side floating output voltage HO	V <sub>HO</sub>	V <sub>S</sub> -0.3		V <sub>B</sub> +0.3	
Low side and logic fixed supply voltage	V <sub>CC</sub>	-0.3		25	
Low side output voltage LO	V <sub>LO</sub>	-0.3		V <sub>CC</sub> +0.3	
Logic input voltage(HIN, LIN)	V <sub>IN</sub>	-0.3		V <sub>CC</sub> +0.3	
Logic Ground	Com	V <sub>CC</sub> -25		V <sub>CC</sub> +0.3	
Allowable offset voltage SLEW RATE	dV <sub>S</sub> /dt			50	V/ns
Power Dissipation	PD			0.625	W
Thermal resistance, junction to ambient	R <sub>thja</sub>			200	°C/W
Junction Temperature	T <sub>J</sub>			150	°C
Storage Temperature	T <sub>S</sub>			150	°C

Note : Absolute maximum ratings indicate sustained limits beyond which damage to the device may occur. All voltage parameters are absolute voltage referenced to COM, all currents are defined positive into any lead.

## Recommended Operating Ratings

Parameter	Symbol	Min.	Typ.	Max.	Unit
High side floating supply voltage	V <sub>B</sub>	V <sub>S</sub> +10	-	V <sub>S</sub> +20	V
High side floating supply offset voltage	V <sub>S</sub>	6-V <sub>CC</sub>		600	
High side(HO) output voltage	V <sub>HO</sub>	V <sub>S</sub>		V <sub>B</sub>	
Low side(LO) output voltage	V <sub>LO</sub>	COM		V <sub>CC</sub>	
Logic input voltage(HIN, LIN)	V <sub>IN</sub>	COM		V <sub>CC</sub>	
Low side supply voltage	V <sub>CC</sub>	10		20	
Ambient Temperature	T <sub>A</sub>	-40		125	

## ESD Level

Parameter	Pins	Conditions	Level	Unit
Human Body Model(HBM)	V <sub>CC</sub> ,COM,HIN,LIN,LO	R=1.5kΩ, C=100pF	±2,000	V
	V <sub>B</sub> ,HO,VS		±1,500	
Machine Model(MM)	V <sub>CC</sub> ,COM,HIN,LIN,VB,HO,VS	C=200pF	±300	
	LO		±200	
Charged Device Model(CDM)	All Pins		±500	

## Static Electrical Characteristics

( $V_{BIAS}(V_{CC}, V_{BS})=15.0V$ ,  $T_A = 25^\circ C$ , unless otherwise specified. The  $V_{IN}$ ,  $V_{TH}$  and  $I_{IN}$  parameters are referenced to COM. The  $V_O$  and  $I_O$  parameters are referenced to COM and  $V_S$  is applicable to HO and LO.)

Parameter	Symbol	Conditions	Min.	Typ.	Max.	Unit
VCC and VBS supply undervoltage positive going threshold	VCCUV+ VBSUV+		8.2	9.2	10.0	V
VCC and VBS supply undervoltage negative going threshold	VCCUV- VBSUV-		7.6	8.7	9.6	
VCC supply undervoltage lockout hysteresis	VCCUVH VBSUVH		-	0.6	-	
Offset supply leakage current	ILK	$V_B=V_S=600V$	-	-	50	uA
Quiescent VBS supply current	IQBS	$V_{IN}=0V$ or $5V$	-	45	120	
Quiescent VCC supply current	IQCC	$V_{IN}=0V$ or $5V$	-	70	180	
Operating VBS supply current	IPBS	$f_{in}=20kHz$ , rms value	-	-	600	uA
Operating VCC supply current	IPCC	$f_{in}=20kHz$ , rms value	-	-	600	
Logic "1" input voltage	$V_{IH}$		2.9	-	-	V
Logic "0" input voltage	$V_{IL}$		-	-	0.8	
High level output voltage, VBIAS-VO	$V_{OH}$	$I_O=20mA$	-	-	1.0	
Low level output voltage, VO	$V_{OL}$		-	-	0.6	
Logic "1" input bias current	$I_{IN+}$	$V_{IN}=5V$	-	10	20	uA
Logic "0" input bias current	$I_{IN-}$	$V_{IN}=0V$	-	1.0	2.0	
Output high short circuit pulse current	$I_{O+}$	$V_O=0V$ $PW<10\mu s$	250	350	-	mA
Output low short circuit pulsed current	$I_{O-}$	$V_O=V_B$ , $PW<10\mu s$	500	650	-	
Allowable negative VS pin voltage for HIN signal propagation to HO	$V_S$		-	-9.8	-7	V

## Dynamic Electrical Characteristics

( $V_{BIAS}(V_{CC}, V_{BS})=15.0V$ ,  $V_S=COM$ ,  $C_L=1000pF$  and  $T_A = 25^\circ C$ , unless otherwise specified.)

Parameter	Symbol	Conditions	Min.	Typ.	Max.	Unit
Turn-on propagation delay	$t_{on}$	$V_S=0V$	100	170	300	ns
Turn-off propagation delay	$t_{off}$	$V_S=0V$ or $600V$	100	200	300	
Turn-on rise time	$t_r$		20	60	140	
Turn-off fall time	$t_f$		-	30	80	
Delay matching, HS & LS turn-on/off	MT		-	-	50	

## Typical Characteristics

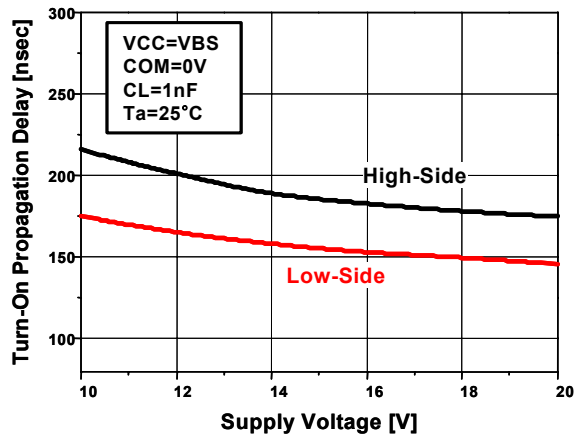

Fig. 1 Turn-On Propagation Delay vs. Supply Voltage

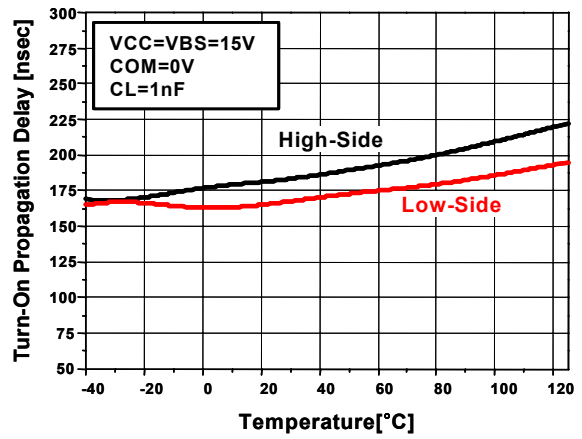

Fig. 2 Turn-On Propagation Delay vs. Temperature

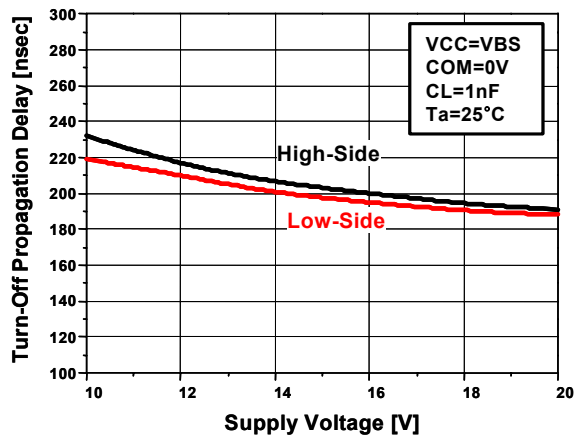

Fig. 3 Turn-Off Propagation Delay vs. Supply Voltage

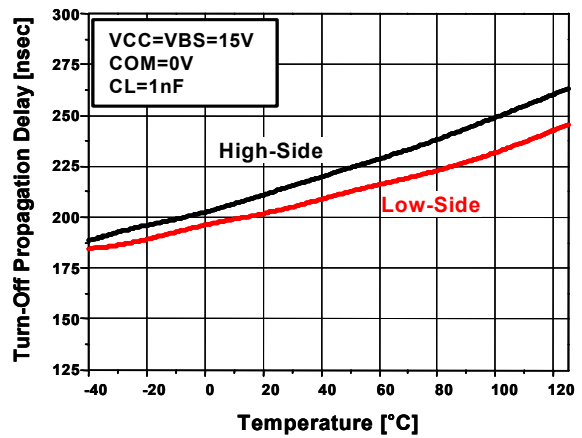

Fig. 4 Turn-Off Propagation Delay vs. Temperature

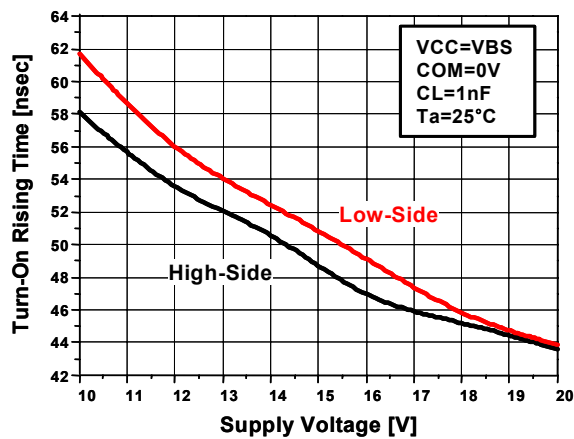

Fig. 5 Turn-On Rising Time vs. Supply Voltage

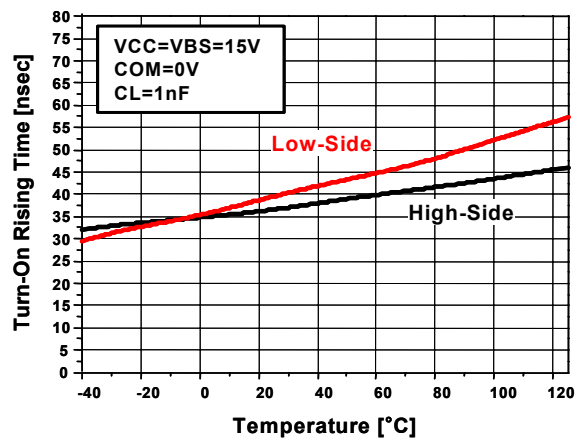

Fig. 6 Turn-On Rising Time vs. Temperature

### Typical Characteristics(cont')

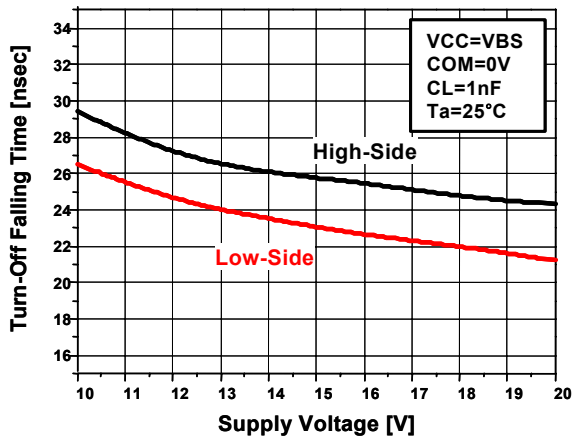

Fig. 7 Turn-Off Falling Time vs. Supply Voltage

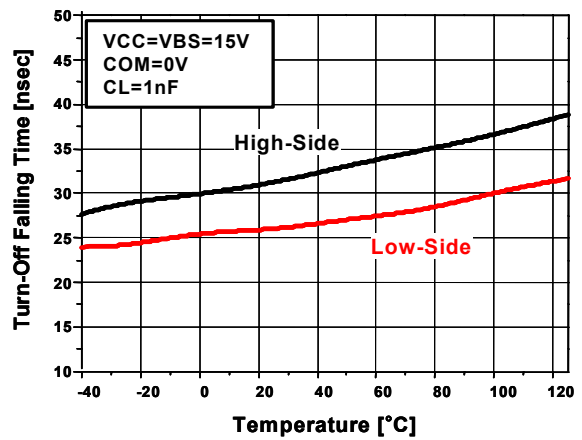

Fig. 8 Turn-Off Falling Time vs. Temperature

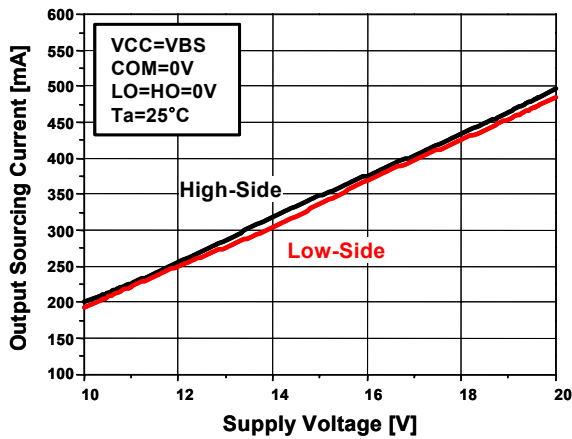

Fig. 9 Output Sourcing Current vs. Supply Voltage

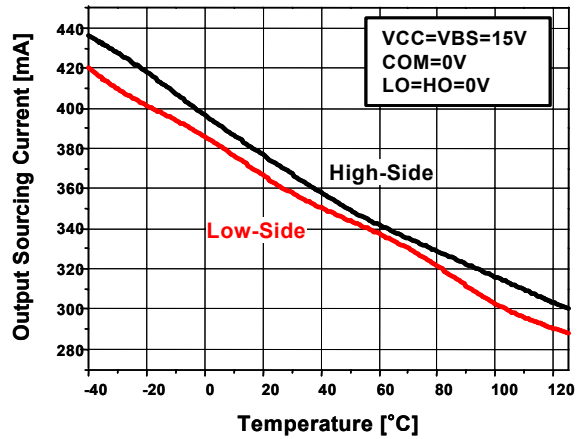

Fig. 10 Output Sourcing Current vs. Temperature

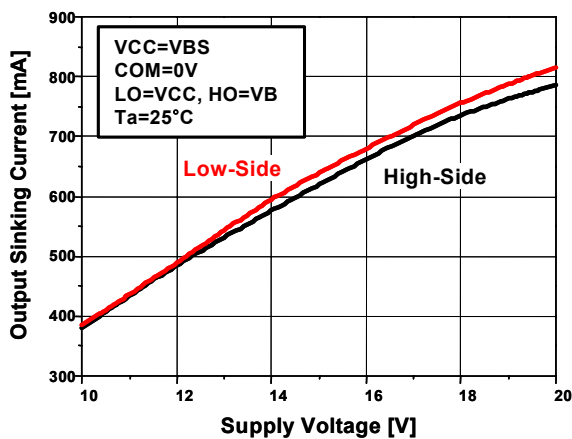

Fig. 11 Output Sinking Current vs. Supply Voltage

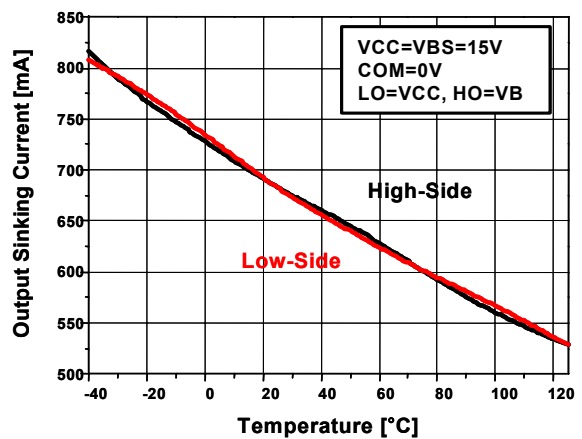

Fig. 12 Output Sinking Current vs. Temperature

## Typical Characteristics

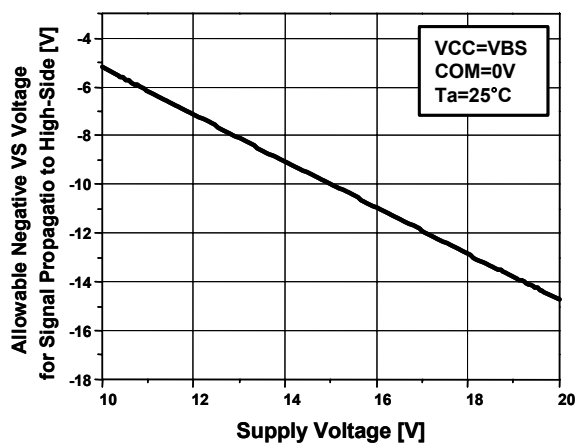

Fig. 13 Allowable Negative VS Voltage for Signal Propagation to High Side vs. Supply Voltage

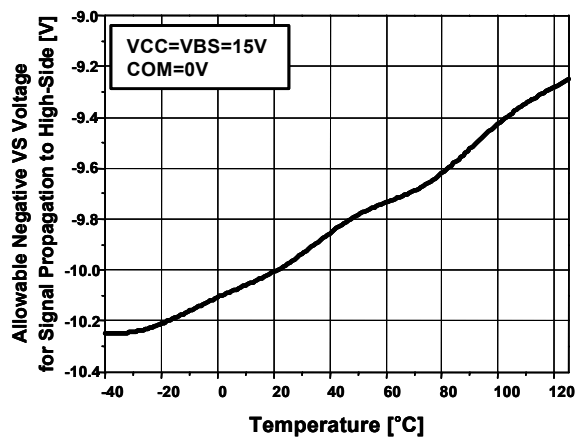

Fig. 14 Allowable Negative VS Voltage for Signal Propagation to High Side vs. Temperature

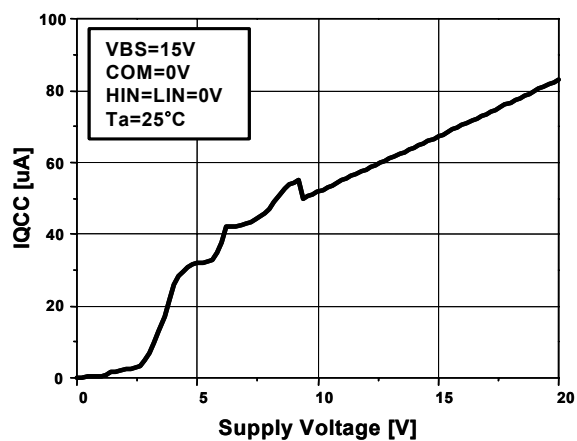

Fig. 15 IQCC vs. Supply Voltage

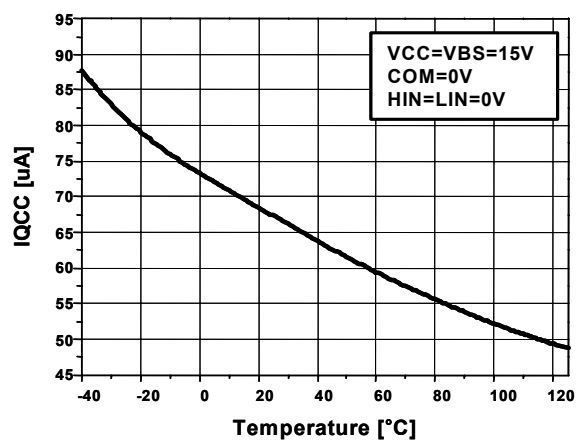

Fig. 16 IQCC vs. Temperature

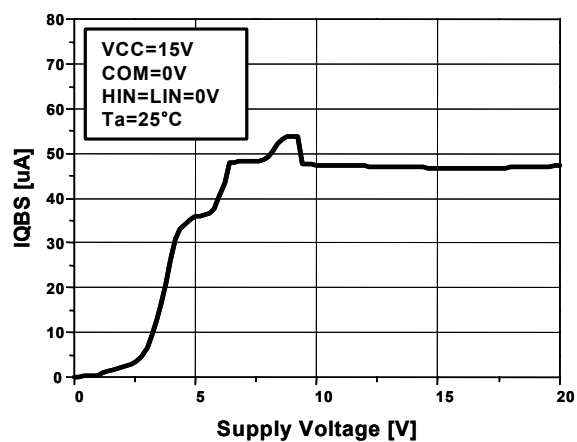

Fig. 17 IQBS vs. Supply Voltage

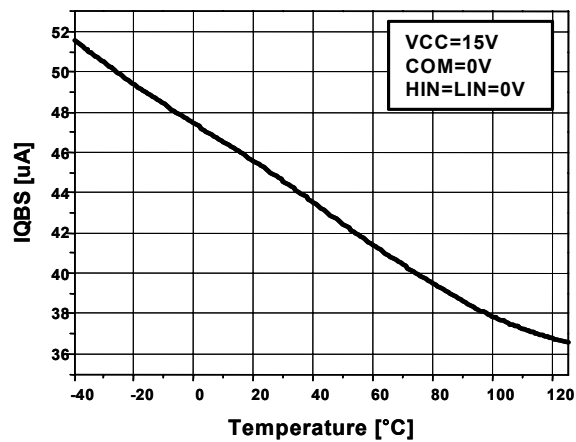

Fig. 18 IQBS vs. Temperature

## Typical Characteristics

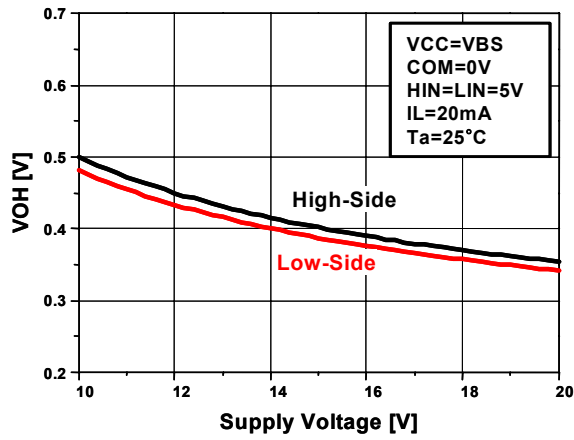

Fig. 19 High Level Output Voltage vs. Supply Voltage

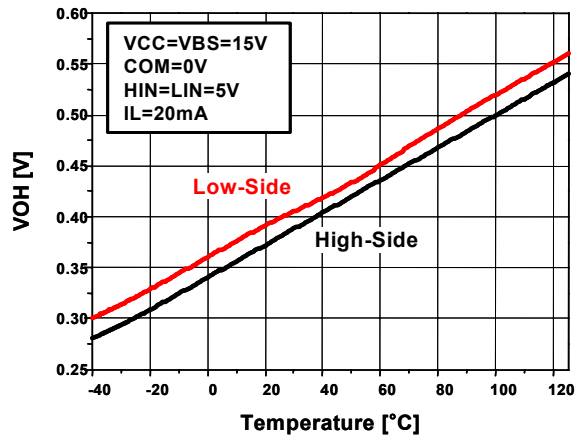

Fig. 20 High Level Output Voltage vs. Temperature

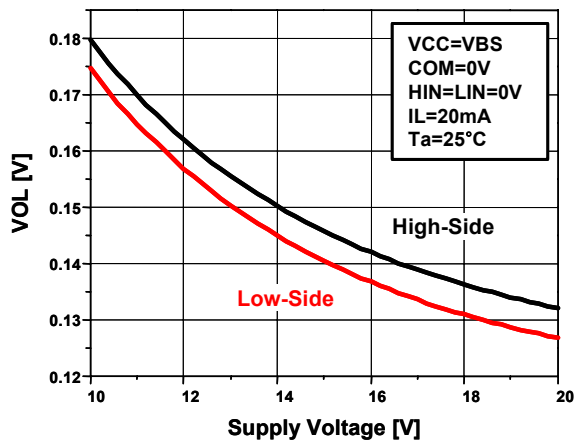

Fig. 21 Low Level Output Voltage vs. Supply Voltage

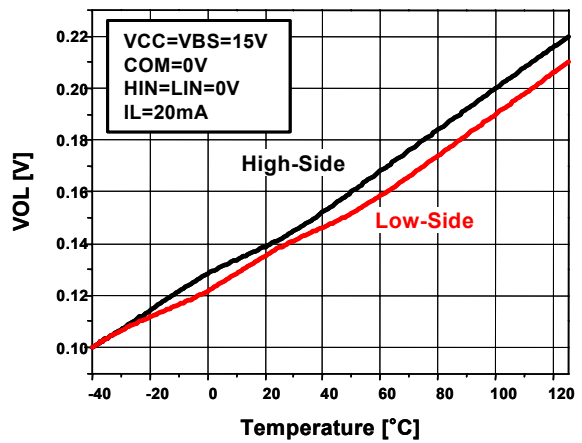

Fig. 22 Low Level Output Voltage vs. Temperature

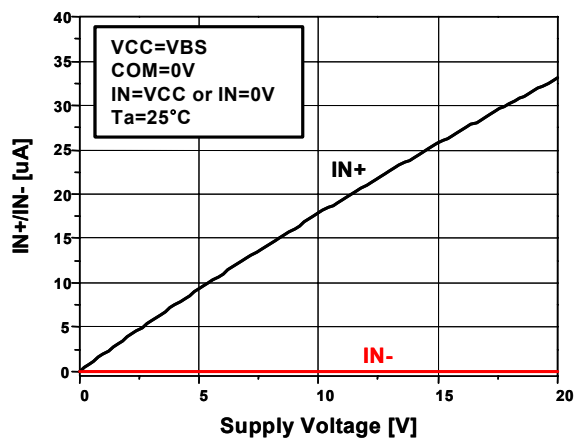

Fig. 23 Input Bias Current vs. Supply Voltage

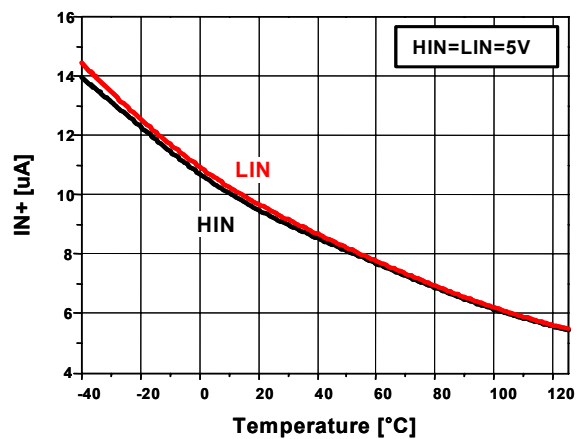

Fig. 24 Input Bias Current vs. Temperature



### Typical Characteristics

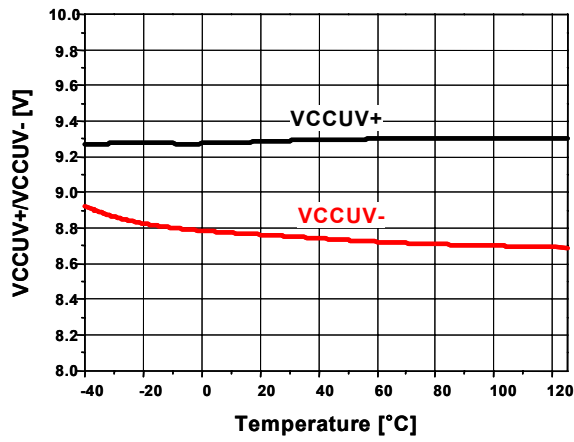

Fig. 25 VCC UVLO Threshold Voltage vs. Temperature

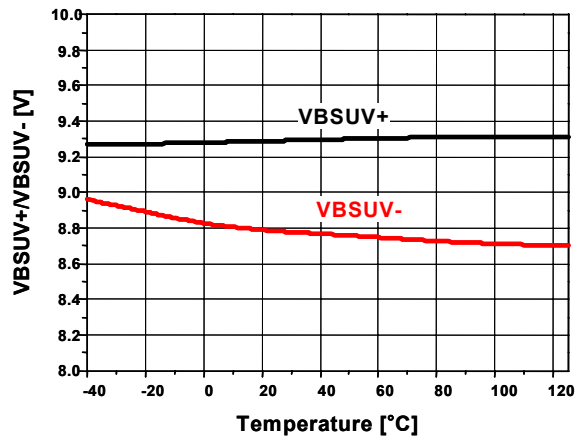

Fig. 26 VBS UVLO Threshold Voltage vs. Temperature

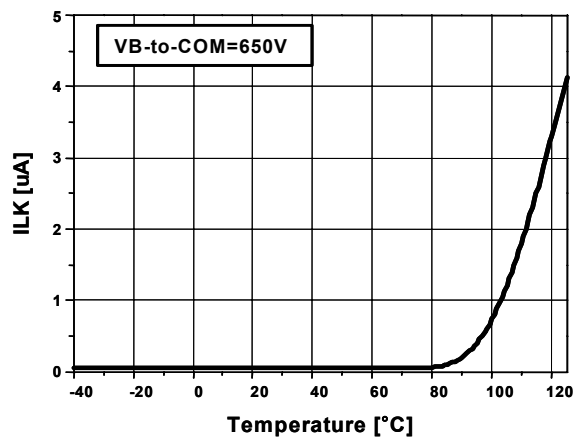

Fig. 27 VB to COM Leakage Current vs. Temperature

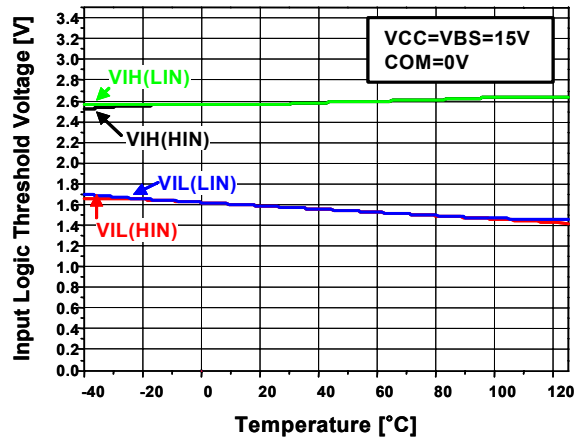

Fig. 28 Input Logic Threshold vs. Temperature

## Typical Characteristics

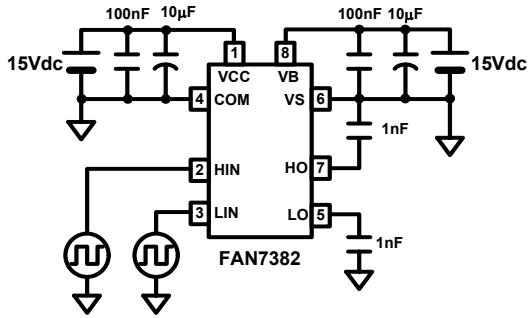

Fig. 29 Switching Time Test Circuit

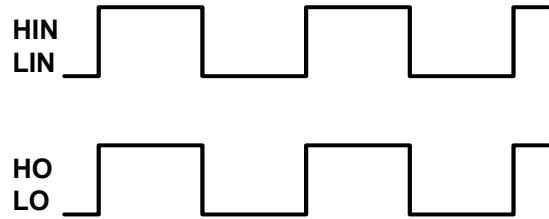

Fig. 30 Input / Output Timing Diagram

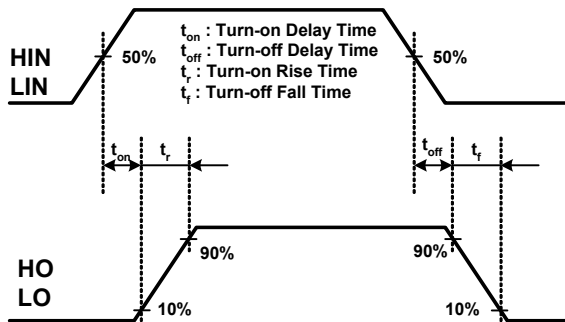

Fig. 31 Switching Time Waveform Definitions

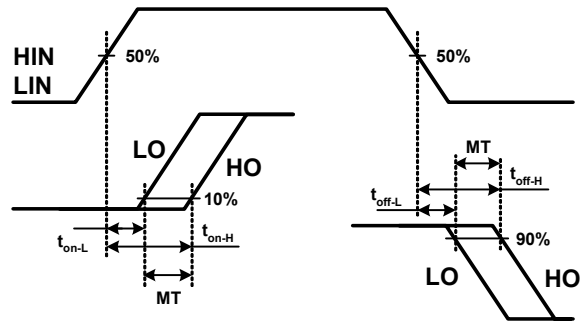
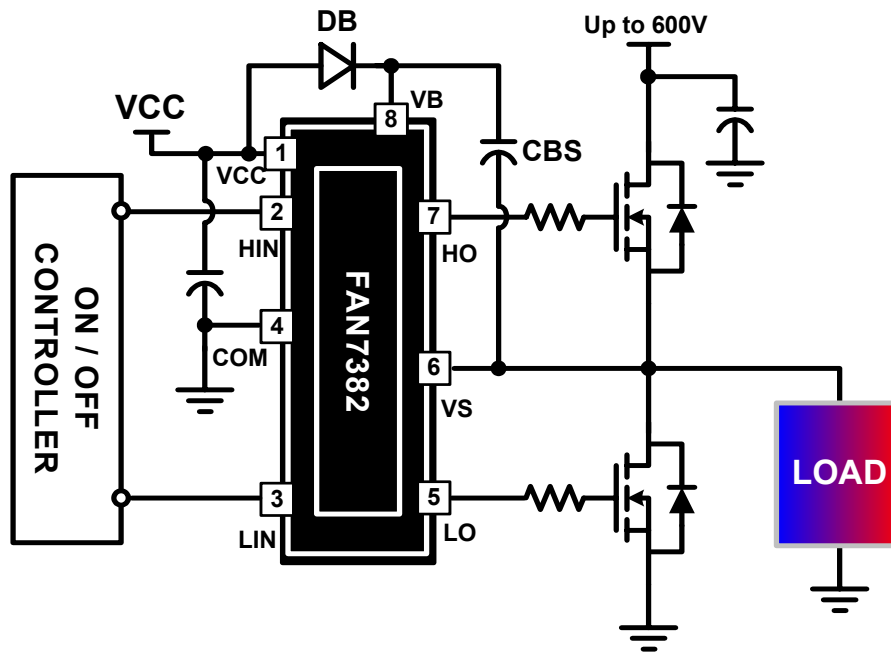

Fig. 32 Delay Matching Waveform Definition

## Typical Application Circuit



## Mechanical Dimensions

### Package

Dimensions in millimeters

## 8-SOP

Symbol	Inches		Millimeters		Notes
	Min.	Max.	Min.	Max.	
A	.053	.069	1.35	1.75	
A1	.004	.010	0.10	0.25	
B	.013	.020	0.33	0.51	
C	.0075	.010	0.20	0.25	5
D	.189	.197	4.80	5.00	2
E	.150	.158	3.81	4.01	2
e	.050 BSC		1.27 BSC		
H	.228	.244	5.79	6.20	
h	.010	.020	0.25	0.50	
L	.016	.050	0.40	1.27	3
N	8		8		6
$\alpha$	0°	8°	0°	8°	
ccc	—	.004	—	0.10	

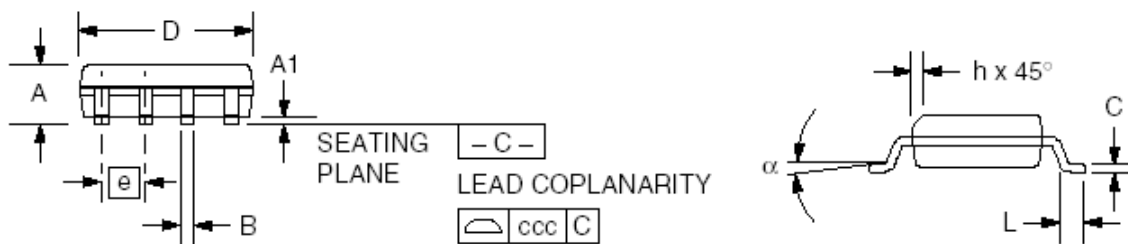
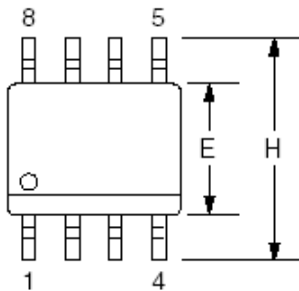

#### Notes:

1. Dimensioning and tolerancing per ANSI Y14.5M-1982.
2. "D" and "E" do not include mold flash. Mold flash or protrusions shall not exceed .010 inch (0.25mm).
3. "L" is the length of terminal for soldering to a substrate.
4. Terminal numbers are shown for reference only.
5. "C" dimension does not include solder finish thickness.
6. Symbol "N" is the maximum number of terminals.

## Ordering Information

Device	Package	Operating Temperature	Packing
FAN7382M	8SOIC	-40°C ~ +125°C	Tube
FAN7382MX			Tape & Reel

### DISCLAIMER

FAIRCHILD SEMICONDUCTOR RESERVES THE RIGHT TO MAKE CHANGES WITHOUT FURTHER NOTICE TO ANY PRODUCTS HEREIN TO IMPROVE RELIABILITY, FUNCTION OR DESIGN. FAIRCHILD DOES NOT ASSUME ANY LIABILITY ARISING OUT OF THE APPLICATION OR USE OF ANY PRODUCT OR CIRCUIT DESCRIBED HEREIN; NEITHER DOES IT CONVEY ANY LICENSE UNDER ITS PATENT RIGHTS, NOR THE RIGHTS OF OTHERS.

### LIFE SUPPORT POLICY

FAIRCHILD'S PRODUCTS ARE NOT AUTHORIZED FOR USE AS CRITICAL COMPONENTS IN LIFE SUPPORT DEVICES OR SYSTEMS WITHOUT THE EXPRESS WRITTEN APPROVAL OF THE PRESIDENT OF FAIRCHILD SEMICONDUCTOR CORPORATION. As used herein:

1. Life support devices or systems are devices or systems which, (a) are intended for surgical implant into the body, or (b) support or sustain life, and (c) whose failure to perform when properly used in accordance with instructions for use provided in the labeling, can be reasonably expected to result in a significant injury of the user.
2. A critical component in any component of a life support device or system whose failure to perform can be reasonably expected to cause the failure of the life support device or system, or to affect its safety or effectiveness.