

U902A MAIN BOARD PB5493-1 (2050XSH)
PB5494-1 (2050XS)

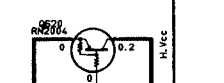

XXXXXXXX I 5Vp-p SDA

5Vp-p I 1000000

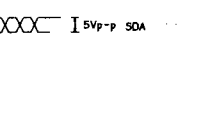
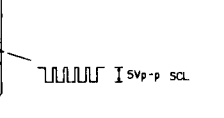
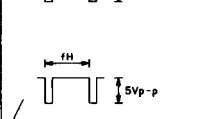
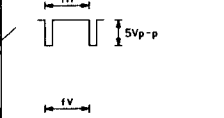
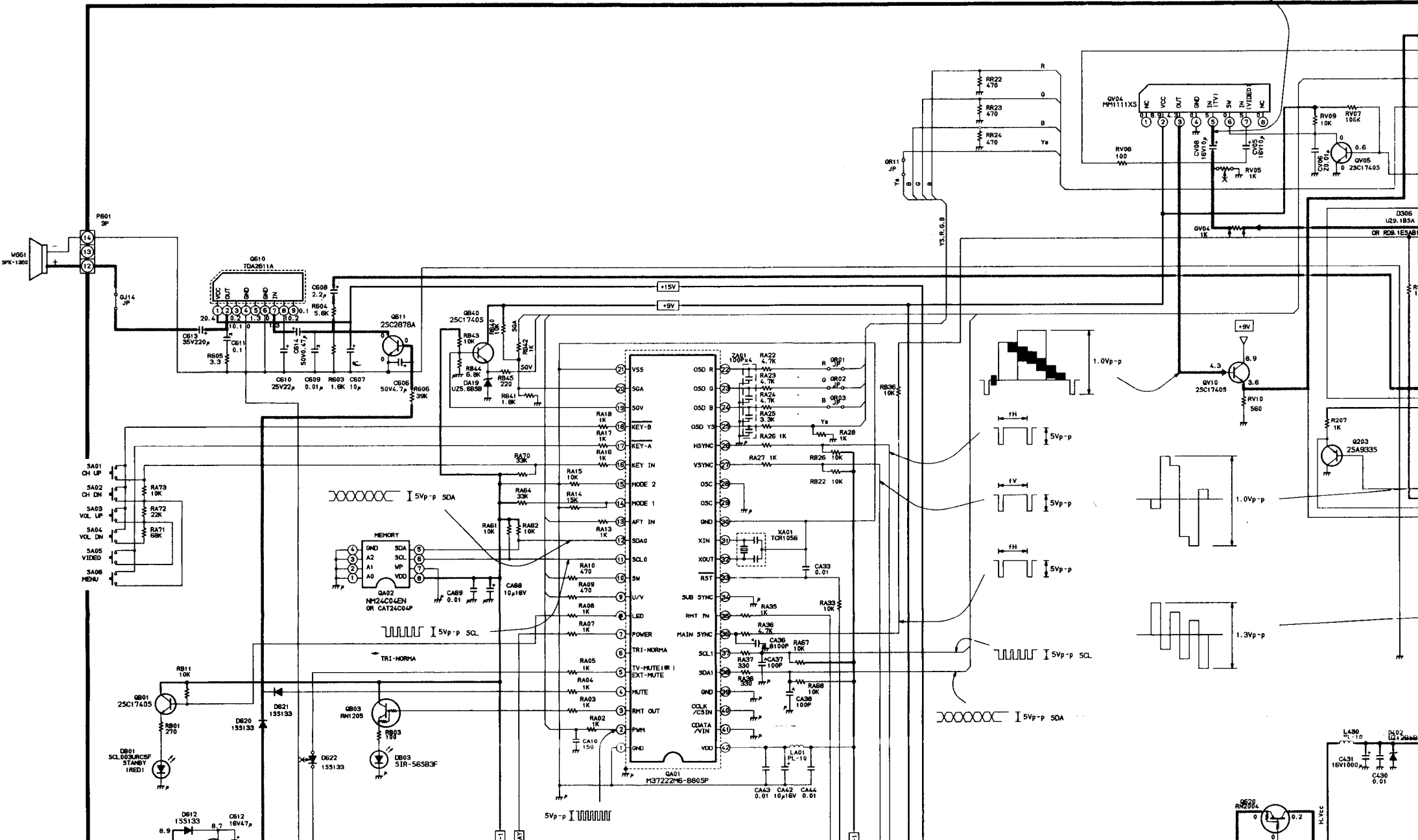
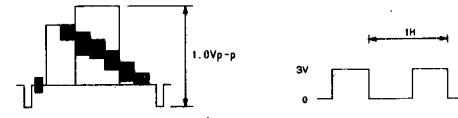
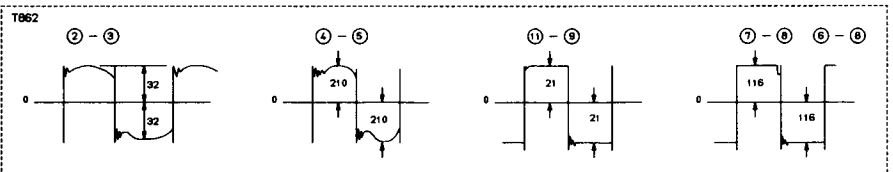
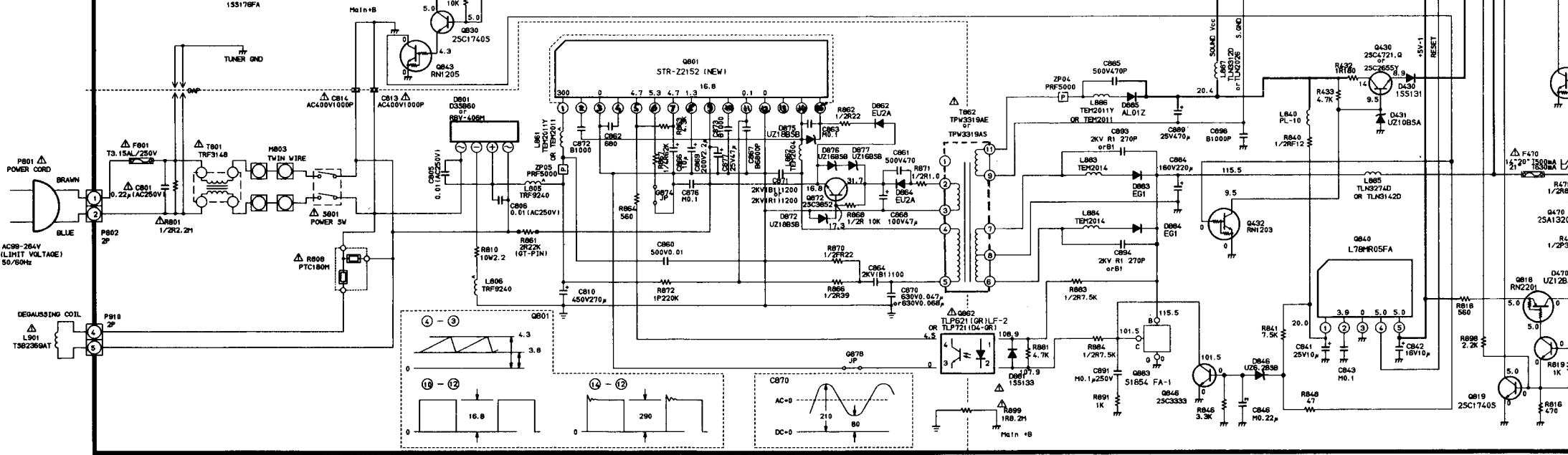
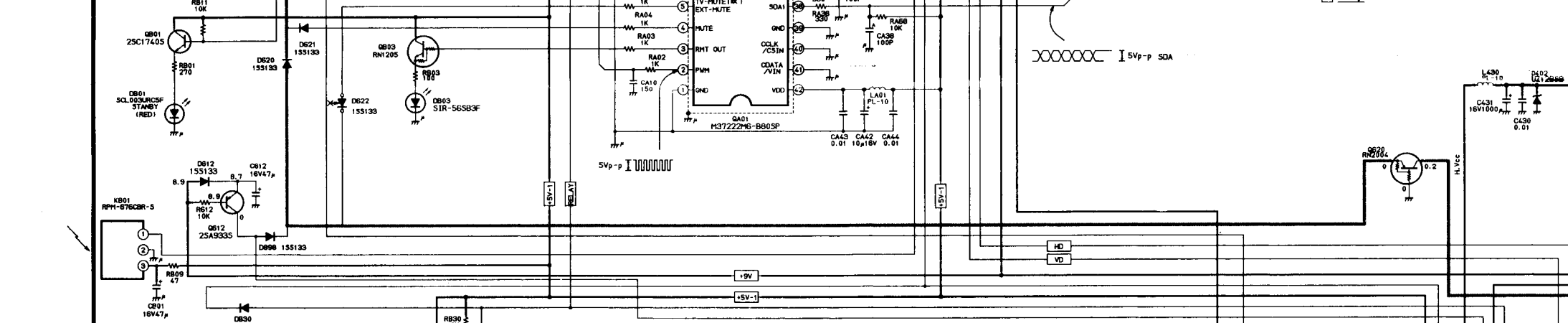

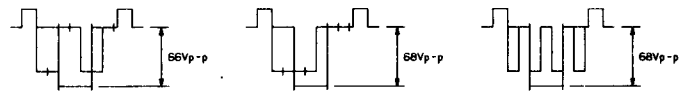
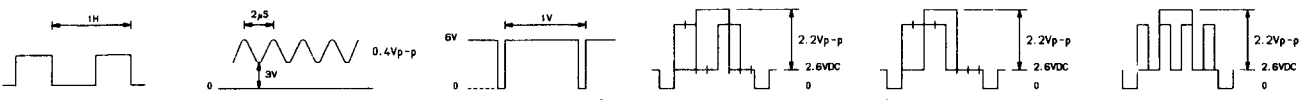

U902B CRT DRIVE BOARD
 PB5493-2(2050XSH)
 PB5494-2(2050XS)

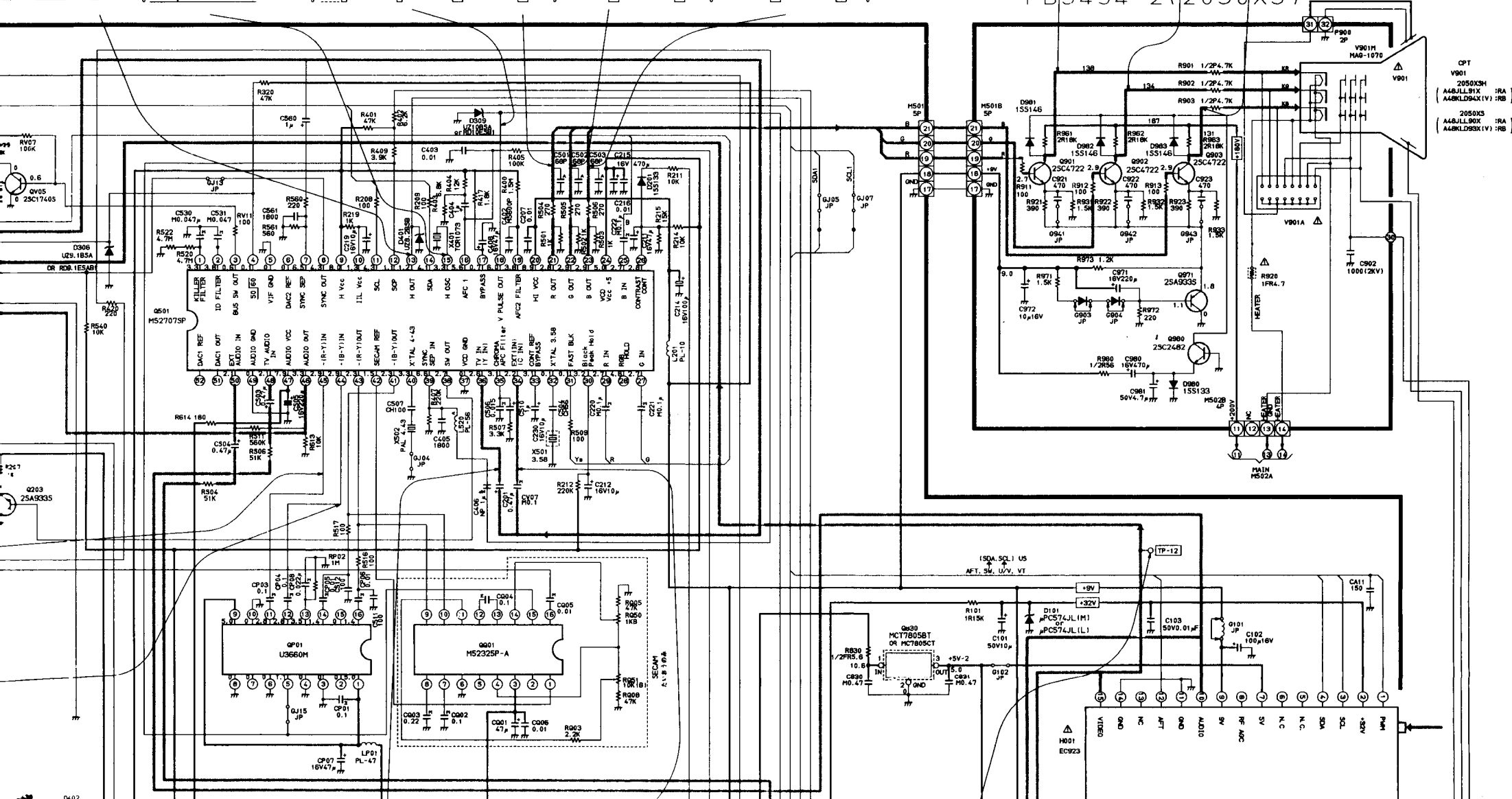

- CPT
 V901
 2050XSH
 (A46JLL91X :RA
 A46KLD94X (V) :RB)
 2050XS
 (A46JLL90X :RA
 A46KLD93X (V) :RB)

