

高速整流ダイオード

FAST RECOVERY DIODE

■外形寸法：Outline Drawings

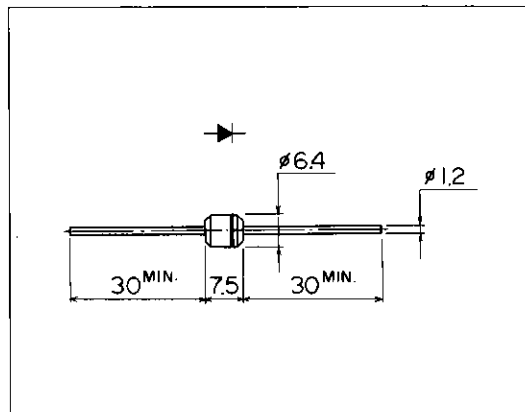

■特長：Features

- カラーTVダンパー用に最適
Most suitable for color T.V. damper.
- メサ形のため耐圧が高い
High voltage by mesa design.
- 高信頼性
High reliability

■用途：Applications

- 高速スイッチング
High speed switching.

■表示：Marking

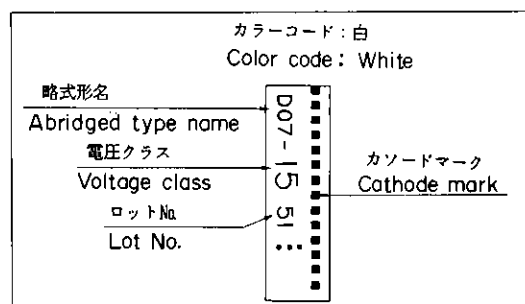

■定格と特性：Maximum Ratings and Characteristics

●絶対最大定格：Absolute Maximum Ratings

Items	Symbols	Conditions	Ratings		Units
			-13	-15	
ピーク繰り返し逆電圧 Repetitive Peak Reverse Voltage	V_{RRM}		1300	1500	V
平均順電流 Average Forward Current	$I_{F(AV)}$	$T_l = 125^\circ\text{C}$	1.5		A
サージ電流 Surge Current	I_{FSM}	正弦波 Sine wave 10ms	50		A
接合温度 Operating Junction Temperature	T_j		-40 ~ +150		$^\circ\text{C}$
保存温度 Storage Temperature	T_{stg}		-40 ~ +150		$^\circ\text{C}$

●電気的特性(特に指定がない限り周囲温度 $T_a=25^\circ\text{C}$ とする)

Electrical Characteristics ($T_a=25^\circ\text{C}$ Unless otherwise specified)

Items	Symbols	Conditions	Max.	Units
順電圧 Forward Voltage Drop	V_{FM}	$I_{FM}=4\text{A}$	1.2	V
逆電流 Reverse Current	I_{RRM}	$V_R=V_{RRM}$	10	μA
逆回復時間 Reverse Recovery Time	t_{rr}	$I_F=0.1\text{A}, I_R=0.1\text{A}$	1.5	μs

A

■特性曲線：Characteristics

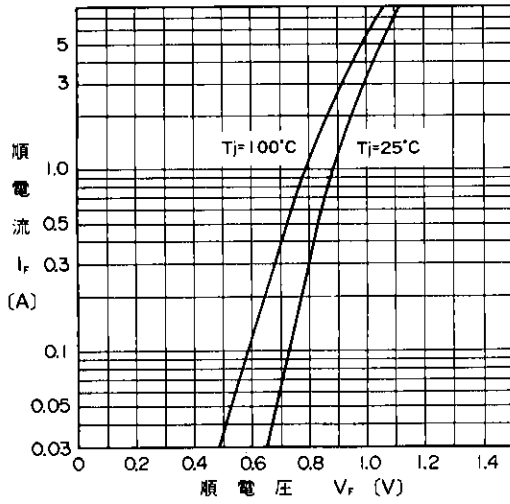

順特性 (代表特性)
Forward Characteristics

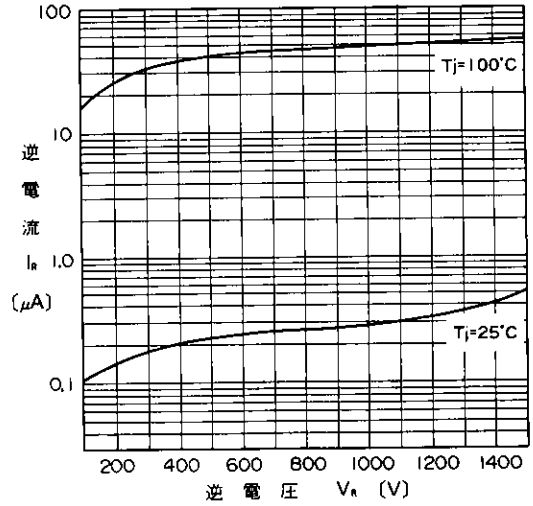

逆特性 (代表特性)
Reverse Characteristics

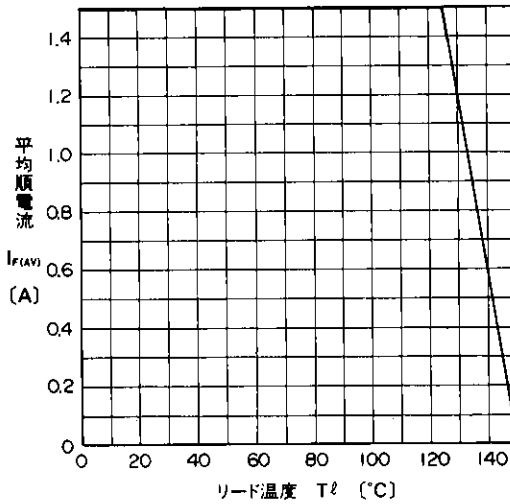

平均順電流—リード温度特性
Current Derating ($I_{F(AV)}-T_a$)

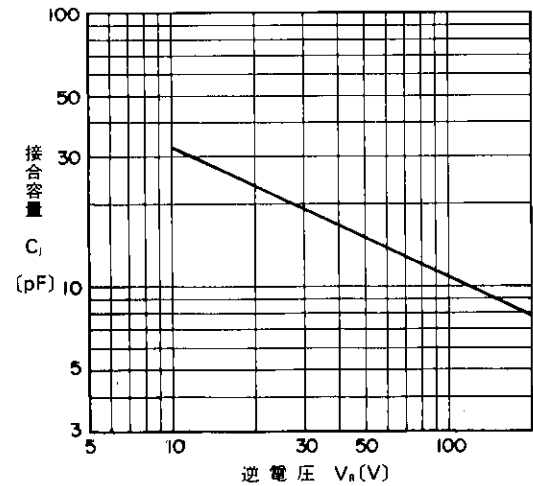

接合容量特性 (代表特性)
Junction Capacitance Characteristics

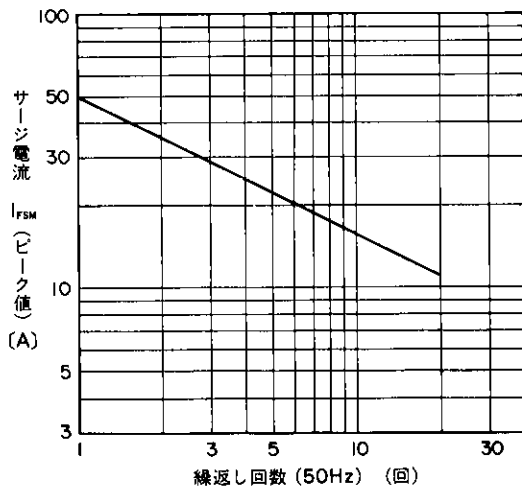

サージ電流耐量
Surge Capability

For more information, contact:

Collmer Semiconductor, Inc.

P.O. Box 702708

Dallas, TX 75370

972-233-1589

972-233-0481 Fax

<http://www.collmer.com>

This datasheet has been download from:

www.datasheetcatalog.com

Datasheets for electronics components.